

Overview

- 4 Megapixel IR distance up to 100m / 328ft
- True WDR 120dB
- 4.8mm to 120mm Lens 25x Optical Zoom
- H.265, H.264, MJPEG
- IP67, IK10
- NDAA Compliant
- ONVIF Profile G, S, T

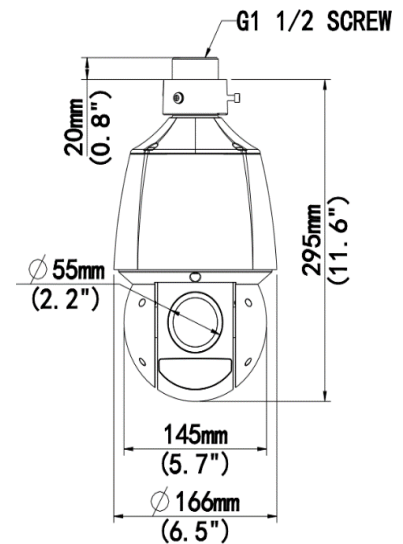















Technical Specifications

Device					
Image Sensor:	1 / 2.8", 4MP Progressive Scan CMOS				
Min Illumination:	Color: 0.003Lux (F1.5, AGC ON) 0Lux with IR				
Shutter Time:	Auto/Manual, 1 ~ 1/100000s				
Lens:	4.8mm to 120mm AF automatic focusing and motorized zoom lens				
WDR:	120 dB				
S/N:	>56dB				
Angle of View :	H: 52.20°~2.74°, V: 30.81°~1.54°, O: 64.20°~3.23°				
Angle Adjustment:	360° (endless), -15° ~ 90° (auto reverse)				
Digital Zoom	16x				
Optical Zoom	25x				
Day & Night:	IR-Cut Filter with Auto Switch (ICR)				
IR Range:	Up to 100m (328ft) IR range				
Compression Standard					
Video Compression:	H.265, H.264, MJPEG				
Video Bit Rate:	128 Kbps~16 Mbps				
Triple-Stream:	Yes				
Analytics:	Motion detection, Audio detection, Tampering Alarm, Line crossing detection, Intrusion Detection, Enter Area, Leave Area Detection				
Image					
Max. Image Resolution:	2688*1520				
Frame Rate:	30fps (2688*1520)				
ROI Codec:	Support				
Image Setting:	White Balance, Digital Noise Reduction, Smart IR, HLC, BLC, Defog				
DORI					
	Lens (mm)	Detect (m)	Observe (m)	Recognize (m)	Identify (m)
DORI	4.8	119.3	47.7	23.9	11.9
Distance	120	2475.0	990.0	495.0	247.5
Network					
Protocols:	IPv4, IGMP, ICMP, ARP, TCP, UDP, DHCP, PPPoE, RTP, RTSP, RTCP, DNS, DDNS, NTP, FTP, UPnP, HTTP, HTTPS, SMTP, 802.1x, SNMP, QoS, RTMP,SSL/TLS				

Technical Specifications

Interface	
Communication Interface:	10M/100M Base-TX Ethernet
Edge Storage:	Micro SD, up to 256 GB
Audio Compression:	G.711U,G.711A
Audio I/O:	1/1
Alarm I/O:	2/1
Serial Port:	1 x RS485
General	
Safety:	CE: EN 62368-1, UL: UL 62368-1
EMC	FCC: FCC Part 15 CE-EMC: EN 55032/ EN 55035/ EN IEC 61000-3-2/ EN 61000-3-3
Operating Conditions:	Temperature: -40°C~70°C(-40°F~158°F), Humidity: ≤95%RH (Non-Condensing)
Power Consumption:	Max 21.0 W
Power Supply:	DC 12V±25% 3A, PoE+ (IEEE 802.3at)
Weather Proof Rating:	IP67
Vandal Resistant:	IK10
Dimensions:	Ø166 x 295mm (Ø6.5" x 11.6")
Net Weight:	3.05kg (6.72lb)
Software:	No license required for use with Video Insight Software

Optional Accessories

WALL	 M-PTZ-WM +  M-PTZ-JB
	 M-Parapet
POLE	 M-PTZ-WM +  M-PTZ-JB +  M-PTZ-PM
CORNER	 M-PTZ-WM +  M-PTZ-JB +  M-PTZ-CNR
PENDANT	 M-CM +  M-PTZ Pendant-EX-L OR  M-PTZ Pendant-EX--S
	 M-CM OR  M-PTZ Pendant

© i-PRO Co., Ltd. All Rights Reserved. i-PRO, Viewnetcam.com, advidia, VideoInsight, CloUDE, and Unified Digital Evidence are registered trademarks or trademarks of i-PRO Co., Ltd. or i-PRO Americas Inc. in various jurisdictions. All other trademarks are the property of their respective owners.