

Web Guide

WV-S66700-Z3LN/ WV-S66700-Z3N/
WV-S66700-Z3L/ WV-S66700-Z3/
WV-S66600-Z3LN/ WV-S66600-Z3N/
WV-S66600-Z3L/ WV-S66600-Z3/
WV-S66300-Z4LN/ WV-S66300-Z3LN/
WV-S66300-Z4N/ WV-S66300-Z3N/
WV-S66300-Z4L/ WV-S66300-Z3L/
WV-S66300-Z4/ WV-S66300-Z3/
(continued)

WV-X66700-Z3LK/ WV-X66700-Z3K/
WV-X66700-Z3LS/ WV-X66700-Z3S/
WV-X66600-Z3LK/ WV-X66600-Z3K/
WV-X66600-Z3LS/ WV-X66600-Z3S/
WV-X66300-Z4LK/ WV-X66300-Z3LK/
WV-X66300-Z4K/ WV-X66300-Z3K/
WV-X66300-Z4LS/ WV-X66300-Z3LS/
WV-X66300-Z4S/ WV-X66300-Z3S

Contents

1. Set up	1
1.1 Install on the ceiling	1
1.1.1 Install using Base Bracket WV-QJB505-W	1
1.1.2 Install using Ceiling Mount Bracket WV-QEM505-W	1
1.2 Install on the wall	1
1.2.1 Install using Wall Mount Bracket WV-QWL501-W and Mount Bracket WV-QSR506-W	1
1.2.2 Install using Wall Mount Bracket WV-QWL502-W	1
1.3 Install in the pole	2
1.3.1 Install using Wall Mount Bracket WV-QWL502-W	2
2. Connect to the camera	3
2.1 i-PRO Configuration Tool (iCT)	3
2.2 IP Setting Software	3
2.3 Access the camera	3
2.4 About Live image pages	5
3. Set the camera	7
3.1 Check whether the object is of the proper size.	7
3.2 Adjust the image quality	7
3.2.1 Set the light intensity control mode depending on the installation location and installation area.	7
3.2.2 Set white balance depending on the lighting environment you install.	8
3.2.3 Sets night time black-and-white switching mode	9
3.3 Recording setting (SD Memory Card)	10
3.3.1 Install the SD Memory Card	10
3.3.2 Record using SD Memory Card	10
3.3.3 Play back images stored on the SD Memory Card	10
3.4 Adjust the zoom/focus	11
3.5 Hide some of the images	11

3.6	Display the angle, direction, magnification, etc. in the image	12
3.7	Set the camera operation	12
3.7.1	Limit the camera's operating range	12
3.7.2	Move the camera automatically	13
3.8	Identify sounds with AI	15
3.9	Record sound	15
3.10	Set up events	16
3.10.1	Detect object movements	16
3.11	Enhance communication security	17
3.12	Detect data falsification	17
3.13	Set the resolution and frame rate	18
3.14	Set the overlay image function	18
3.15	Set the image stream	18
3.15.1	About the Setting of Stream	18
3.15.2	About delivery volume control (bit rate)	19
3.15.3	Reducing Data Capacity with Smart Coding	19
4.	Clean up	21
4.1	Cleaning of Dome cover	21
5.	Specifications	23
5.1	PC environment required	23
5.2	Image capture mode and Resolution	24
5.2.1	Resolution	24
5.2.2	Restrictions	27
5.3	DORI	28
5.4	Streaming performance	30
5.5	About Available Extension software	30
5.6	Lamp	31
5.6.1	Lighting of the lamp	31
5.7	Button	32
5.8	Cable	33
6.	Other	35
6.1	Initialize	35

6.2	Check the software version	35
6.3	Upgrade software	36
6.4	Order of setting when adjusting image quality	36
6.5	Adjusting object brightness (bright scenes)	37
6.5.1	Adjusting brightness	37
6.6	Adjusting object brightness (dark scenes)	37
6.6.1	Adjust the maximum gain	37
6.6.2	Adjust the maximum shutter	38
6.7	Reducing white flickering and blacking on the screen	38
6.7.1	Set Super Dynamic	38
6.7.2	Set the backlight compensation	39
6.7.3	Set the high light compensation	40
6.7.4	Adjust the adaptive black stretch	40
6.7.5	Adjust the [Pedestal level]	41
6.8	Adjust the object contrast	41
6.8.1	Adjust the contrast	41
6.9	Reduce flicker	42
6.10	Reducing the blur of object (bright scenes)	42
6.10.1	Set intelligent auto (motion priority level)	42
6.10.2	Adjust the maximum shutter	43
6.11	Reducing object blur (dark scenes)	44
6.11.1	Adjust digital noise reduction	44
6.12	Sharpen the outline of the subject	44
6.12.1	Adjust the sharpness level	44
6.13	Adjust the color	45
6.13.1	Adjust color density	45
6.13.2	Adjust the white balance	45
6.14	Reducing object noise (bright scenes)	46
6.14.1	Adjust the sharpness level	46
6.15	Reducing object noise (dark scenes)	46
6.15.1	Adjust digital noise reduction	46
6.16	Troubleshooting	47
6.17	Precautions pertaining to usage	51
6.18	Disclaimer	55
6.19	NETWORK RELATIONSHIP	56

1. Set up
 - 1.2 Install on the wall
-

1. Set up



For detailed instructions on installation, refer to the following.

[Installation](#)

1.1 Install on the ceiling

1.1.1 Install using Base Bracket WV-QJB505-W

The URL of the movie is as follows.

<https://youtu.be/tZzMNIyPA34>

1.1.2 Install using Ceiling Mount Bracket WV-QEM505-W

The URL of the movie is as follows.

<https://youtu.be/B-y9ZLZICVc>

1.2 Install on the wall

1.2.1 Install using Wall Mount Bracket WV-QWL501-W and Mount Bracket WV-QSR506-W

The URL of the movie is as follows.

<https://youtu.be/TitZq2XfMyo>

1.2.2 Install using Wall Mount Bracket WV-QWL502-W

The URL of the movie is as follows.

1. Set up
 - 1.3 Install in the pole
-

<https://youtu.be/tK9oc3xPFo0>

1.3 Install in the pole

1.3.1 Install using Wall Mount Bracket WV-QWL502-W

The URL of the movie is as follows.

<https://youtu.be/ZKMSOIR7Frg>

- 2. Connect to the camera
 - 2.3 Access the camera
-

2. Connect to the camera

2.1 i-PRO Configuration Tool (iCT)

This is a tool for managing the image monitoring system at a glance.



For more information about i-PRO Configuration Tool (iCT), see the Technical Information website at <Control No.: C0133>.

→[Click here for more information about i-PRO Configuration Tool](#)

2.2 IP Setting Software

Cameras or recorders on the same network can be automatically detected and set up in the network.



For more information on the IP Setting Software, see the Technical Information website at <Control No.: C0123>.

→[Click here for more information on the IP Setting Software](#)

2.3 Access the camera

1. Launch a IP Setting Software
 - The model number and MAC address of the detected camera are displayed.
 - The default for [Network Settings] is [DHCP].



•If you cannot obtain an IP address from the DHCP server, set the IP address to 192.168.0.10.

2. Connect to the camera
 - 2.3 Access the camera
-

2. Double-click on the camera's IP address
 - The browser starts and the administrator registration screen is displayed.
 - You need to register as an administrator.

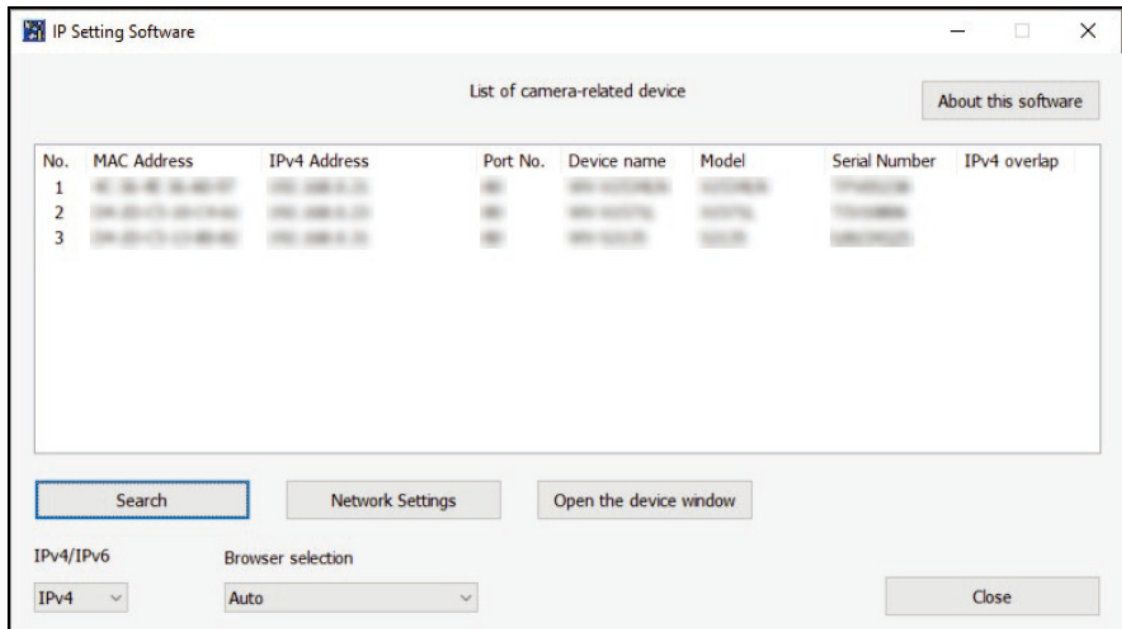

3. Enter administrator username and password
 - The screen for setting the language and date and time is displayed.
4. Set the language, date and time, and screen
 - You can set the language and date and time and change the background color of the screen and the layout of the operation panel.
5. Press [Set]
 - Live image pages is displayed.

- 2. Connect to the camera
- 2.4 About Live image pages

2.4 About Live image pages

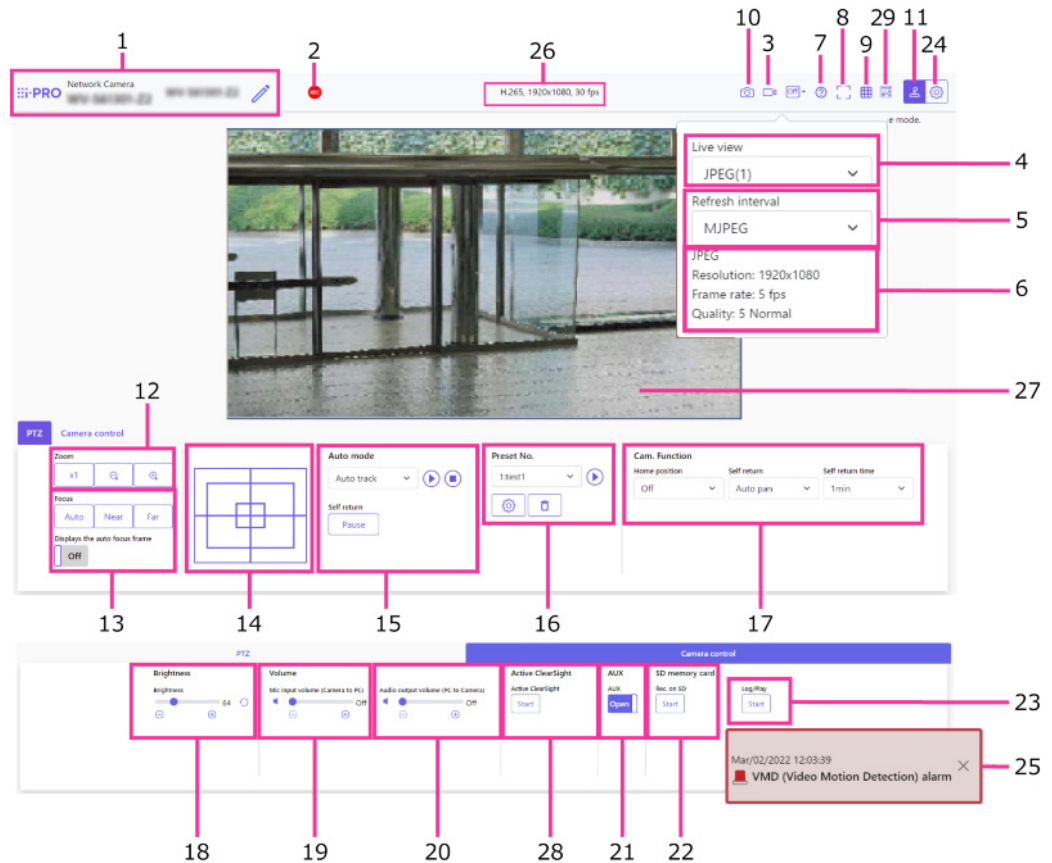

- 1 Camera title
- 2 SD recording status indicator
- 3 Stream selection display button
- 4 Stream - [Live view] pull-down menu
- 5 Stream - [Refresh interval] pull-down menu
- 6 Stream - Stream information display
- 7 Support button
- 8 Full screen button
- 9 [Grid display] buttons
- 10 Snap shot button
- 11 Camera control panel display button
- 12 PTZ Panel [Zoom] Buttons
- 13 PTZ Panel [Focus] Buttons
- 14 PTZ panel - Control pad/buttons

2. Connect to the camera
2.4 About Live image pages

- 15 PTZ panel - [Auto mode]
- 16 PTZ panel - [Preset]
- 17 PTZ panel - [Cam. Function]
- 18 Camera control panel - [Brightness]
- 19 Camera control panel - [Mic input volume (Camera to PC)]
- 20 Camera control panel - [Audio output volume (PC to Camera)]
- 21 Camera control panel - [AUX] button
- 22 [SD memory card] - [Rec. on SD]
- 23 [SD memory card] - [Log/Play]
- 24 [Setup] buttons (Settings panel display button)
- 25 Alarm occurrence notification
- 26 Stream information display
- 27 Main area
- 28 Active ClearSight buttons
- 29 Frame rate / bit rate display button

- 3. Set the camera
 - 3.2 Adjust the image quality
-

3. Set the camera

3.1 Check whether the object is of the proper size.

When using our Extension software, you can check the number of grids to see if it is the right size to recognize object. Refer to <Control No.: C0320> on the following technical information website.

→[For more information about the recommended sizes of Extension software](#)

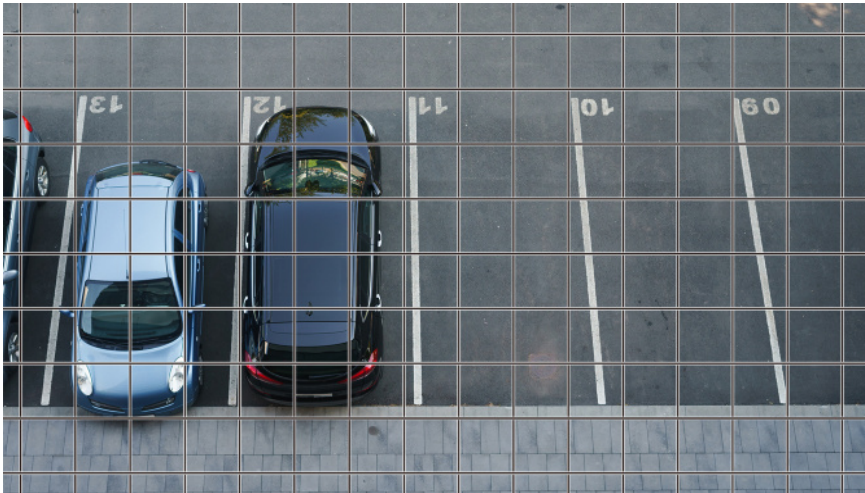

3.2 Adjust the image quality

This section explains how to adjust the image quality when installing the camera.

3.2.1 Set the light intensity control mode depending on the installation location and installation area.

Use [Light control mode] to set the light intensity appropriate for the installation location and area.

- Live image pages configuration panels>Clicking the [Image quality] tabs enables you to set the image quality.

3. Set the camera
3.2 Adjust the image quality

1. Select [Light control mode]
 - To install outdoors: Set [Outdoor scene].
 - For indoor installation: Set [Indoor scene(50Hz)] or [Indoor scene(60Hz)].
50 Hz/60 Hz can be used differently depending on the region.



- Basically, [Fix shutter] is not used.
- For more information about the light control mode, refer to the User Manual.

3.2.2 Set white balance depending on the lighting environment you install.

Use [White balance] to set the white balances appropriate for the installation location and area.

- Live image pages configuration panels>[Detailed setting]>[Camera detailed setting]>[Image] or [Image/Audio] of the Advanced menus on the left>[Image adjust] in the [Image quality] tabs>When [Setup] is clicked, the image quality adjustment setting window is displayed.

1. Select [White balance]
 - Select from [ATW1], [ATW2], and [AWC].

[ATW1]

Set the automatic color temperature tracking mode. The camera continuously checks the color temperature of the light source and automatically adjusts the white balance.

The operating range is about 2700 K to 6000 K.

[ATW2]

Set the automatic color temperature tracking mode. The camera automatically adjusts the white balance under a sodium lamp.

The operating range is from about 2000 K to 6000 K.

[AWC]

Set the automatic white balance control mode. Since the light source is fixed, it is suitable for shooting in a place where the lighting environment does not change.

The operating range is from approximately 2000 K to 10000 K.



Colors may not be reproducible faithfully if the following conditions are met: In such cases, set it to [AWC].

- Largely dark object
- Clear blue sky or the sun at dusk

- 3. Set the camera
 - 3.2 Adjust the image quality
-

- Object with too low illumination

3.2.3 Sets night time black-and-white switching mode

You can switch to color or black-and-white images by using [Day & Night(IR)] when shooting at night.

➤ Live image pages configuration panels>Clicking the [Image quality] tabs enables you to set the image quality.

1. Select [Day & Night(IR)]

- Select from [Off], [On(IR Light Off)], [On(IR Light On)], [Auto1(IR Light Off)], and [Auto2(IR Light On)].

[Off]

This function is used for shooting colored images at night as well.

[On(IR Light Off)]

The picture is always taken in black and white.

[On(IR Light On)]

The picture is always taken in black and white. This setting is used when near-infrared lighting is used at night.

[Auto1(IR Light Off)]

The color image and black-and-white image are automatically switched depending on the brightness (illumination) of the image.

[Auto2(IR Light On)]

The color image and black-and-white image are automatically switched depending on the brightness (illumination) of the image. This is set when the near-infrared illumination is used at night.

- 3. Set the camera
 - 3.3 Recording setting (SD Memory Card)
-

3.3 Recording setting (SD Memory Card)

3.3.1 Install the SD Memory Card

1. Remove the enclosure
2. Insert a microSD memory card into the slot



Use the SD Memory Card formatted on this product.



[Basic] of the Advanced menu>Execute [Insert/Remove SD memory card mode] of the SD Memory Card on the [SD memory card] tab. Execute [Insert/Remove SD memory card mode] and then install or remove the SD Memory Card.

3.3.2 Record using SD Memory Card

This section describes the procedures for turning [Save trigger] to [Manual].

- Live image pages configuration panels>[Detailed setting]>[Camera detailed setting]> [Basic] of the Advanced menus on the left>When [SD memory card] tab is clicked, the SD Memory Card setup page is displayed.
 - (1) Select [Recording format] streams
 - (2) Select [Save trigger] and click [Set].
 - (3) Click [Live] in the upper left corner and click the camera control panel display button.
 - The camera control panel is displayed.
 - (4) Clicking [Start] on [Rec. on SD]
 - Start recording to the SD Memory Card manually.
 - You can stop recording by clicking [Stop]. After stopping, you can resume recording by clicking [Start].

3.3.3 Play back images stored on the SD Memory Card

You can play back images stored on the SD Memory Card.

- Live image pages cameras control panels>Clicking [Log/Play] displays the log list.

3. Set the camera
 - 3.5 Hide some of the images
-

1. View Live image pages and click the camera control panel display button.
2. Press the [Start] on [Log/Play] button
 - The Log List screen is displayed in a separate window.
3. Press the shooting date and time displayed below [Time & date]
 - The playback page is displayed and the saved image is played.

3.4 Adjust the zoom/focus

You can manually or automatically adjust the zoom or focus of the displayed image.

- You can set zoom and focus by clicking [Camera control] on the Live image pages.
1. Configuring [Zoom], [Focus], and [Displays the auto focus frame] on the [PTZ] tabs
 - Left-click the control pad to adjust the horizontal position (PAN) and vertical position (TILT) of the image.
 - Right-click the control pad to adjust the zoom and focus. Zoom can also be adjusted with the mouse wheel operation.

3.5 Hide some of the images

If you set the area to be hidden, you can move the camera's field angle while holding the area to be hidden.

- Live image pages configuration panels>[Detailed setting]>[Camera detailed setting]>[Image/Audio] of the Advanced menus on the left>[Privacy zone] in the [Image quality] tabs>When [Setup] is clicked, the Privacy Zone setting window is displayed.



- (1) Drag the desired area with the mouse and press [Set] button.
 - Privacy zones are set in order from Area 1.
- (2) Select [Status] to view privacy zones
 - Set up the privacy zone in [On]/[Off].

3.6 Display the angle, direction, magnification, etc. in the image

You can select the information displayed in the image when you manually operate it.

- Live image pages configuration panels>[Detail setting]>[Camera detailed setting]>Clicking [PTZ] on the Advanced menu on the left displays the [Cam. Function] menu.
- 1. From the [Camera position display] pull-down menu, select the information you want to view and press [Scene change detection].

3.7 Set the camera operation

Set the camera operation, preset position, and auto tracking.

- Live image pages configuration panels>[Detail setting]>[Camera detailed setting]>When [PTZ] is clicked on the advanced menu on the left, the settings pages for the respective functions are displayed.



In preset position setting, [On] and [Off] of [Super Dynamic] cannot be set.
(WV-S66700-Z3LN, WV-S66700-Z3N, WV-S66700-Z3L, WV-S66700-Z3,
WV-X66700-Z3LK, WV-X66700-Z3K, WV-X66700-Z3LS, WV-X66700-Z3S,
WV-S66600-Z3LN, WV-S66600-Z3N, WV-S66600-Z3L, WV-S66600-Z3,
WV-X66600-Z3LK, WV-X66600-Z3K, WV-X66600-Z3LS, WV-X66600-Z3S)

3.7.1 Limit the camera's operating range

When you want to shoot in a specific area, you can control the shooting area by limiting the camera's operation in the PAN direction and the TILT direction.

- Live image pages configuration panels>[Detail setting]>[Camera detailed setting]>[PTZ] of the Advanced menus on the left>[Position] tabs>Clicking [Advanced settings] on the right-hand side of the [Pan/tilt range setting] displays the configuration pages.
- 1. Set the [Pan/tilt range setting] to [On] and set the angle of view in each direction.



The [Left end] angle should be smaller than the [Right end] angle and the [Bottomend] angle should be larger than the [Top end] angle. If [Upside-down] is set to [On], the [Bottom end] angle must be less than the [Top end] angle.

3.7.2 Move the camera automatically

The selected operation can be started from the [Auto mode] in the [PTZ] pane of the Live imagepages. Settings for each operation are made from the Advanced menu.

3.7.2.1 Automatically track and shoot objects

When movement is detected in the set alarm area, the target is automatically tracked and shot.

- Live image pages configuration panels>[Detail setting]>[Camera detailed setting]>[PTZ] of the Advanced menus on the left>Clicking on the [Auto track setting] tabs displays the auto-tracking settings window.
 1. Set items by clicking [Basic settings]
 - Select the object or size to be detected.
 2. Set auto-tracking by clicking [Auto track activation setting]
 - Select whether to automatically track auto pan, preset sequence, etc.
 3. Set auto-tracking by clicking [Auto track activation setting (Area)]
 - Select whether or not to automatically track [Detection object] in the area you set up.

3.7.2.2 Shoot automatically in the PAN direction

Turn the set range of movement of the PAN automatically to take a picture.

- Live image pages configuration panels>[Detail setting]>[Camera detailed setting]>[PTZ] of the Advanced menus on the left>[Position] tabs>Clicking [Advancedsettings] on the [Auto pan] displays the auto pan setting window.
 1. Set the left and right endpoints using the [Zoom], [Focus], and Control pads/buttons.
 2. Set the stopping time/speed/turn direction with [Auto pan].

3.7.2.3 Take pictures around the designated area

Move the preset position registered as the area you want to shoot in order from the lowest presetnumber.

- Live image pages configuration panels>[Detail setting]>[Camera detailed setting]>[PTZ] of

3. Set the camera

3.7 Set the camera operation

the Advanced menus on the left>[Position] tabs>Clicking [Advancedsettings] on the [Preset sequence setting] displays the preset sequence setting window.

1. Select [Preset sequence 1]
 - The preset position selection screen is displayed.
2. Select the number of the preset position to shoot and set it.

3.7.2.4 Set up patrols

The patrol function stores PAN/TILT/ZOOM/Focus and reproduces the stored operation. When you register a patrol, a patrol is displayed on the [Auto mode] of the Live image pages.

➤ Live image pages [Scene change detection]>[Detail setting]>[Camera detailed setting]>[PT Z]>[Position]>The [Patrol] [Advanced settings] displays the patrol settings window.

1. Select the number of patrols to be stored and the number of patrols to be set.
2. Set [Zoom], [Focus], Control Pad, [Brightness], [Preset]



- For more information on patrols, refer to the User Manual.
- The settings saved in Advanced Settings can be changed by Live image pages.

3.7.2.5 Drop the raindrops on the Dome

This product has the function of dropping rain droplets by clicking the buttons on the screen to quickly move the horizontal (PAN) and vertical (TILT) angles of the camera when the image is affected by rain droplets on Dome.Click the button on the live image screen on the browser to start moving the PAN/TILT of the camera simultaneously, and move back and forth several times between certain angles to remove raindrops.Finally, position refresh is performed to return to normal shooting.(Operation time: approx. 20 seconds)

➤ Live image pages camera control panel display button>You can set in Active ClearSight onthe [Camera control] panel.

1. Select [Start]
 - [Active ClearSight] is set.

3.7.2.6 Automatically correct the misaligned angle

When [Auto position refresh] is set to ON, the position is refreshed automatically and moves tothe original position when the PAN (turn) angle is misaligned by a certain amount.

- Live image pages configuration panels>[Detail setting]>[Camera detailed setting]>[PTZ] of the Advanced menus on the left>[Cam. Function] tabs>Click to display the setting page.
 1. Select [On] of [Auto position refresh]
 - [Auto position refresh] is set.

3.8 Identify sounds with AI

Image monitoring can be enhanced by identifying and detecting human cries, broken glass sounds, horns, guns, and other sounds.

- Live image pages configuration panels>[Detail setting]>[Camera detailed setting]>[Alarm] of the Advanced menus on the left>Clicking on the [Audio detection] tabs displays the configuration pages.



AI Sound Classification See below for more information.

→[WHITE PAPER](#)

1. Set [Audio detection] to [On] to set sound detection.
2. Select Sensitivity of Detection with [Detection sensitivity].
3. Select the sound to be detected by [AI analytics target].
 - Selection of [Other] is not recommended in conjunction with other sounds detected. For example, when a gun sound is detected with the settings for detecting two sounds: [Gunshot] and [Other], it is detected as two sounds.



For validated external microphones, see below.

→[Verification result of external microphones](#)

3.9 Record sound

Audio data can be recorded to SD recording when alarm is detected.

1. Select whether to record audio data in the SD Memory Card setup page.
 - [On] saves audio data in a movie (MP4 format).

- [Off]: Audio data is not saved in movies (MP4 format).

3.10 Set up events

You can set the alarm to detect the operation of an area or interference to the camera, or the operation when the alarm is detected.

- Live image pages configuration panels>[Detailed setting]>[Camera detailed setting]>[Easy Setup] of the Advanced menus on the left>Clicking on the [Event action] tabs displays the configuration pages.



- Refer to the User Manual for instructions on configuring events.
- Refer to the User Manual for instructions on how to configure Internet disclosure.

3.10.1 Detect object movements

When an alarm is activated, the camera operates as set. There are patterns for the alarms when the specified area moves and when the camera is blocked.

- Live image pages configuration panels>[Detailed setting]>[Camera detailed setting]>[Alarm] of the Advanced menus on the left>Clicking on the [VMD area] tabs displays the configuration pages.



Refer to the user manual for details of all alarms.

3.10.1.1 Set the area for detecting the movement of an object

Set the area for detecting the movement of an object using the motion detection function using video images.



1. Select the preset position number to be set for the motion detection area and press [Start].
 - The Set Operation Detection Area screen is displayed.
2. Drag through the image to set the area.
 - You can set the areas in order.
3. Adjust the [Detection area] and [Detection sensitivity] using the slider bar and then press [Set].

3.11 Enhance communication security

Setting up HTTPS encrypts camera access and enhances communication security.

- Refer to the following support videos for the HTTPS setting method (pre-installation).
→[Support video](#)
- For information about how to configure HTTPS (CA certificate), refer to the following supported videos.
→[Support video](#)
- Refer to the following support videos for the HTTPS setting method (pre-installation).
- For information about how to configure HTTPS (CA certificate), refer to the following supported videos.

3.12 Detect data falsification

If you set Falsification Detection, you can detect the falsified data on the SD Memory Card using the dedicated software.

Refer to the following support videos for how to set up tampering detection.

→[Support video](#)

3.13 Set the resolution and frame rate

- Live image pages configuration panels>[Stream] tabs>Set in [Image capture mode] of [Common].



- Refer to the User Manual for details on settings and frame rates.
- For more information on resolution, see the following.
→ [Image capture mode and Resolution](#)

3.14 Set the overlay image function

You can specify the position to overlay the uploaded image or specify the color to be transmitted. In the model where the SD Memory Card can be recorded, the overlay displayed images are recorded during recording.

Refer to the User Manual for details on how to configure the settings.

- Live image pages configuration panels>[Detail setting]>[Camera detailed setting]>[Basic] of the Advanced menus on the left>Configure in the [Overlay image] tabs.
 1. Select an image with [Overlay] set to [On].
 2. Set [Position], [Permeation], and [Selection of color to be penetrated]
 3. Press [Set]

3.15 Set the image stream

3.15.1 About the Setting of Stream

You can configure whether to deliver streams, whether to use H.265 or H.264 compression, the resolution, image quality, and how to deliver streams.

- Live image pages configuration panels>Use the [Stream] tabs. The streams of H.265 and H.264 images are set in [Stream] on the [Stream] tabs.
 - Refer to the following for how to distribute.
→ [About delivery volume control \(bit rate\)](#)
 - For the image compression method, refer to the following.

→[Reducing Data Capacity with Smart Coding](#)

- Refer to the User Manual for details of each setting method.

3.15.2 About delivery volume control (bit rate)

The following types of delivery modes are used to control the amount of delivery (bit rate) of the stream, and settings are made accordingly. You can also use smart coding, such as [Smart VIQS], to reduce the amount of data. For information about controlling the amount of stream delivery, see the following. Refer to the User Manual for details.

→[Reducing Data Capacity with Smart Coding](#)

- **Fixed bit rate:**

The H.265 (or H.264) images are delivered at the bit rate set by [Max bit rate (per client) *].

- **Variable bit rate:**

The H.265 (or H.264) images are delivered at the frame rate set by [Frame rate*] while maintaining the image quality level set by [Image/Privacy]. At this time, the bit rate is varied within the maximum bit rate set by [Max bit rate (per client) *]. The recording capacity varies depending on the [Image/Privacy] settings and the object status.

- **Specify Frame Rate:**

H.265 (or H.264) images are delivered at the frame rate set by [Frame rate*].

- **Best effort delivery:**

Depending on the bandwidth of the networks, H.265 (or H.264) images are delivered with varying bit rates within the maximum bit rate set by [Max bit rate (per client) *].

3.15.3 Reducing Data Capacity with Smart Coding

Smart coding is a data-compression technique that optimizes the compression ratio by reducing compression and high compression in the background to clearly show the human face, and by object.

- Live image pages configuration panels>[Detail setting]>[Camera detailed setting]>[Image] or [Image/Audio] of the Advanced menus on the left>Clicking [Image] displays the Smart Coding configuration.

- 3. Set the camera
 - 3.15 Set the image stream
-

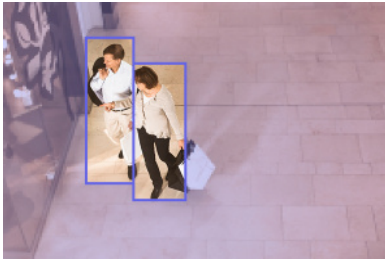

This image is an image. This is different from the actual view of the screen.

[Smart VIQS]

The image quality of the area where the object (head, people, automobiles, and motorcycles) is displayed is maintained at a high level. Images other than objects are delivered in such a way that low or medium image quality is maintained and the amount of data is reduced.

[Smart P-picture control]

In order to reduce the amount of data, data generation (macroblock) is reduced in areas other than where objects (head, people, automobiles, and motorcycles) are displayed.

[GOP control]

You can reduce the amount of data.

4. Clean up



- Turn off the power before starting operation. Doing so may result in injury.
- Do not apply or use organic solvents such as benzene and thinner. The enclosure may become discolored. Follow the precautionary statement when using chemical foil.
- Do not loosen or remove the screws not specified in the operation manual.

4.1 Cleaning of Dome cover

<WV-S66700-Z3LN/ WV-S66700-Z3N/ WV-S66600-Z3LN/ WV-S66600-Z3N/ WV-S66300-Z4LN/ WV-S66300-Z3LN/ WV-S66300-Z4N/ WV-S66300-Z3N/
WV-X66700-Z3LK/ WV-X66700-Z3K/ WV-X66600-Z3LK/ WV-X66600-Z3K/ WV-X66300-Z4LK/ WV-X66300-Z3LK/ WV-X66300-Z4K/ WV-X66300-Z3K>

(ClearSight coating models only)



- To clean the Dome cover, wash out hard sand grains and other adhered materials by pouring fresh water containing no lubricant or silicone substance using a hose or spray. If the stain is not removed, wipe with a soft sponge soaked with the above fresh water.
- Do not wipe dry (e.g., spread oil on surfaces or damage the advanced ClearSight Coating).
- Use neutral detergent for dishware and rinse thoroughly after use if dirt does not come off after wiping. If detergents other than neutral (weakly alkaline or slightly acidic) are used, the hydrophilic capacity of the product may deteriorate or the surface coating may peel off.
- Do not use organic solvents such as benzene and thinner.
- If spraying is used, use it after emptying to remove the initial impurities.
- If the Advanced ClearSight Coating of the Dome cover becomes ineffective due to improper maintenance, the Dome cover needs to be replaced (paid) to restore the Advanced ClearSight Coating to its original state. Contact your dealer or contractor.

4. Clean up

4.1 Cleaning of Dome cover

<WV-S66700-Z3L/ WV-S66700-Z3/ WV-S66600-Z3L/ WV-S66600-Z3/ WV-S66300-Z4L/
WV-S66300-Z3L/ WV-S66300-Z4/ WV-S66300-Z3/

WV-X66700-Z3LS/ WV-X66700-Z3S/ WV-X66600-Z3LS/ WV-X66600-Z3S/ WV-X66300-
Z4LS/ WV-X66300-Z3LS/ WV-X66300-Z4S/ WV-X66300-Z3S>

(Non ClearSight coating models only)



If the Dome covers are dirty, clean them with lens-cleaning paper (for cleaning cameras and eyeglasses). If dust or dirt adheres to the cover, the Dome cover may be damaged. If it is dirty, it is recommended to wash with water.

5. Specifications

5.1 PC environment required

CPU:	Intel® Core™ Processor family <When using an image capture size of 1920 x 1080 or lower> -Intel® Core™ i5-6500 or more -Intel® Core™ i7-6700 or higher recommended <When using an image capture size higher than 1920 x 1080> -Intel® Core™ i7-11700 or higher recommended
Memory:	<When using an image capture size of 1920 x 1080 or lower> Recommended at least 4 GB (2 GB x 2, dual channel) <When using an image capture size higher than 1920 x 1080> Recommended at least 16 GB (8 GB x 2, dual channel)
Network function:	10BASE-T/100BASE-TX/1000BASE-T 1 port
Sound function:	Sound Card (for voice function)
Image display function:	Image capture size: 1920 x 1080 pixels or more <When using an image capture size of 3840 x 2160> High Image capture size monitoring: 3840 x 2160 pixels or more Color: 24 bits or more of True Color
Compatible OS:	Microsoft Windows 11 Microsoft Windows 10
Web browser:	Google Chrome™ Firefox Microsoft Edge (after Chromium)
Other:	Adobe® Reader® or Acrobat Reader® (For viewing PDF files)

5.2 Image capture mode and Resolution



- The bit rate of streams is restricted to [Bandwidth control(bit rate)] on the [Network] tabs of network pages.
- If the refresh interval is short, the bit rate may be exceeded depending on the object.
- Depending on the number of concurrent users or the combination of functions used, the bit rate may be lower than the set value. Confirm the image delivered after setting.

5.2.1 Resolution

This is the resolution. The initial value is underlined.

WV-S66700-Z3LN/ WV-S66700-Z3N/ WV-S66700-Z3L/ WV-S66700-Z3/ WV-X66700-Z3LK/ WV-X66700-Z3K/ WV-X66700-Z3LS/ WV-X66700-Z3S

Image capture mode	Stream (1)	Stream(2)	Stream(3)	Stream(4)	JPEG(1)*1	JPEG(2)
16:9 (30fps)	<u>3840x2160</u>	3840x2160			<u>3840x2160</u>	
	2560x1440	2560x1440*2			2560x1440	
16:9 (25fps)		<u>1920x1080</u>			1920x1080	
		1280x720	<u>1280x720</u>	1280x720	1280x720	
		640x360	640x360	<u>640x360</u>	640x360	<u>640x360</u>
		320x180	320x180	320x180	320x180	
	(A)*3	Max 30(25) fps*4*5	Max 15(12.5) fps	Max 15(12.5) fps	Max 15(12.5) fps	Max 5(4.2) fps*6*7
(B)*3	Max 15(12.5) fps	Max 30(25) fps*4*5	Max 30(25) fps*4*5	Max 30(25) fps*4*5		

*1 Only the same image capture sizes set for “Stream(1)”, “Stream(2)”, “Stream(3)”, “Stream(4)” and “JPEG(2)” are selectable.

*2 “2560x1440” of “Stream(2)” can be selected in case of “Stream(1)” is set to “2560x1440”.

*3 The maximum frame rates of “Stream(1)” to “Stream(4)” are either the combination of (A) or (B).

*4 When “3840 x 2160” or “2560 x 1440” is selected for “Stream(2)”, the frame rate will be limited to max. “15 fps (12.5 fps)”.

5. Specifications

5.2 Image capture mode and Resolution

*5 When "1280 x 720" is selected for "Stream(4)", the frame rate will be limited to max. "15 fps (12.5 fps)".

*6 When the image capture size is "3840 x 2160", the refresh interval is limited to 1 fps max. and when the image capture size is "2560 x 1440", the refresh interval is limited to 2 fps max. (2.1 fps).

*7 When [Off] is selected for [Stream transmission] for all of "Stream(1)", "Stream(2)", "Stream(3)", and "Stream(4)", the maximum frame rate is 30 fps (25 fps).

WV-S66600-Z3LN/ WV-S66600-Z3N/ WV-S66600-Z3L/ WV-S66600-Z3/ WV-X66600-Z3LK/ WV-X66600-Z3K/ WV-X66600-Z3LS/ WV-X66600-Z3S

Image capture mode	Stream (1)	Stream(2)	Stream(3)	Stream(4)	JPEG(1)*1	JPEG(2)
16:9 (30fps)	3328x1872	3328x1872			3328x1872	
	2560x1440	2560x1440*2			2560x1440	
16:9 (25fps)		1920x1080			1920x1080	
		1280x720	1280x720	1280x720	1280x720	
		640x360	640x360	640x360	640x360	640x360
		320x180	320x180	320x180	320x180	
(A)*3	Max 30(25) fps*4*5	Max 15(12.5) fps	Max 15(12.5) fps	Max 15(12.5) fps	Max 5(4.2) fps*6*7	Max 15 (12.5) fps*7
(B)*3	Max 15(12.5) fps	Max 30(25) fps*4*5	Max 30(25) fps*4*5	Max 30(25) fps*4*5		

*1 Only the same image capture sizes set for "Stream(1)", "Stream(2)", "Stream(3)", "Stream(4)" and "JPEG(2)" are selectable.

*2 "2560x1440" of "Stream(2)" can be selected in case of "Stream(1)" is set to "2560x1440".

*3 The maximum frame rates of "Stream(1)" to "Stream(4)" are either the combination of (A) or (B).

*4 When "3328 x 1872" or "2560 x 1440" is selected for "Stream(2)", the frame rate will be limited to max. "15 fps (12.5 fps)".

*5 When "1280 x 720" is selected for "Stream(4)", the frame rate will be limited to max. "15 fps (12.5 fps)".

*6 When the image capture size is "3328 x 1872", the refresh interval is limited to 1 fps max. and when the image capture size is "2560 x 1440", the refresh interval is limited to 2 fps max. (2.1 fps).

*7 When [Off] is selected for [Stream transmission] for all of "Stream(1)", "Stream(2)",

5. Specifications

5.2 Image capture mode and Resolution

“Stream(3)”, and “Stream(4)”, the maximum frame rate is 30 fps (25 fps).

WV-S66300-Z4LN/ WV-S66300-Z3LN/ WV-S66300-Z4N/ WV-S66300-Z3N/ WV-S66300-Z4L/ WV-S66300-Z3L/ WV-S66300-Z4/ WV-S66300-Z3/ WV-X66300-Z4LK/ WV-X66300-Z3LK/ WV-X66300-Z4K/ WV-X66300-Z3K/ WV-X66300-Z4LS/ WV-X66300-Z3LS/ WV-X66300-Z4S/ WV-X66300-Z3S

Image capture mode	Stream (1)	Stream(2)	Stream(3)	Stream(4)	JPEG(1)	JPEG(2)
16:9(60fps)	1920x1080	1920x1080			1920x1080	
16:9(50fps)	1280x720	1280x720	1280x720		1280x720	
	640x360	640x360	640x360	640x360	640x360	640x360
	320x180	320x180	320x180	320x180	320x180	
	Max 60(50) fps	Max 10(8.3) fps	Max 10(8.3) fps	Max 10(8.3) fps	Max 5(4.2) fps ^{*1}	Max 15 (12.5) fps ^{*1}
<u>16:9(30fps)</u>	<u>1920x1080</u>	<u>1920x1080</u>			<u>1920x1080</u>	
16:9(25fps)	1280x720	<u>1280x720</u>	1280x720		1280x720	
	640x360	640x360	<u>640x360</u>	<u>640x360</u>	640x360	<u>640x360</u>
	320x180	320x180	320x180	320x180	320x180	
	Max 30(25) fps	Max 30(25) fps	Max 30(25) fps	Max 30(25) fps	Max 5(4.2) fps ^{*1}	Max 15 (12.5) fps ^{*1}
4:3(30fps)	1280x960	1280x960			1280x960	
4:3(25fps)	640x480	640x480	640x480	640x480	640x480	640x480
	320x240	320x240	320x240	320x240	320x240	
	Max 30(25) fps	Max 30(25) fps	Max 30(25) fps	Max 30(25) fps	Max 5(4.2) fps ^{*1}	Max 15 (12.5) fps ^{*1}
4:3(15fps)	2048x1536				2048x1536	
4:3(12.5fps)		1280x960			1280x960	
		640x480	640x480	640x480	640x480	640x480
		320x240	320x240	320x240	320x240	
	Max 15(12.5) fps	Max 15(12.5) fps	Max 15(12.5) fps	Max 15(12.5) fps	Max 5(4.2) fps ^{*2}	Max 15(12.5) fps

*1 When [Off] is selected for [Stream transmission] for all of “Stream(1)”, “Stream(2)”, “Stream(3)”, and “Stream(4)”, the maximum frame rate is 30 fps (25 fps).

*2 When [Off] is selected for [Stream transmission] for all of “Stream(1)”, “Stream(2)”, “Stream(3)”, and “Stream(4)”, the maximum frame rate is 15 fps (12.5 fps).

5. Specifications

5.2 Image capture mode and Resolution

5.2.2 Restrictions

WV-S66700-Z3LN/ WV-S66700-Z3N/ WV-S66700-Z3L/ WV-S66700-Z3/ WV-X66700-Z3LK/ WV-X66700-Z3K/ WV-X66700-Z3LS/ WV-X66700-Z3S

Image capture mode	Extension software	Stabilizer	SD recording	Smart coding	Super Dynamic	Intelligent auto	Privacy zone	Auto tracking
16:9(30/25fps)	Yes*1	Yes*2 *3	Yes	Yes	Yes*4	Yes	Yes*5	Yes

*1 When Extension software is running, the frame rate will be limited to max. "15 fps (12.5 fps)".

*2 When [Stabilizer] is set to [On], [Super Dynamic] setting is [Off].

*3 When [Stabilizer] is set to [On], the frame rate will be limited to max. "15 fps (12.5 fps)".

*4 When [Super Dynamic level] is set to 30 or more, the frame rate will be limited to max. "15 fps (12.5 fps)".

*5 When [Privacy zone] is set to [On], the frame rate will be limited to max. "15 fps (12.5 fps)".

WV-S66600-Z3LN/ WV-S66600-Z3N/ WV-S66600-Z3L/ WV-S66600-Z3/ WV-X66600-Z3LK/ WV-X66600-Z3K/ WV-X66600-Z3LS/ WV-X66600-Z3S

Image capture mode	Extension software	Stabilizer	SD recording	Smart coding	Super Dynamic	Intelligent auto	Privacy zone	Auto tracking
16:9(30/25fps)	Yes*1	Yes*2 *3	Yes	Yes	Yes*4	Yes	Yes*5	Yes

*1 When Extension software is running, the frame rate will be limited to max. "15 fps (12.5 fps)".

*2 When [Stabilizer] is set to [On], [Super Dynamic] setting is [Off].

*3 When [Stabilizer] is set to [On], the frame rate will be limited to max. "15 fps (12.5 fps)".

*4 When [Super Dynamic level] is set to 30 or more, the frame rate will be limited to max. "15 fps (12.5 fps)".

*5 When [Privacy zone] is set to [On], the frame rate will be limited to max. "15 fps (12.5 fps)".

WV-S66300-Z4LN/ WV-S66300-Z3LN/ WV-S66300-Z4N/ WV-S66300-Z3N/ WV-S66300-Z4L/ WV-S66300-Z3L/ WV-S66300-Z4/ WV-S66300-Z3/ WV-X66300-Z4LK/ WV-X66300-Z3LK/ WV-X66300-Z4K/ WV-X66300-Z3K/ WV-X66300-Z4LS/ WV-X66300-Z3LS/ WV-X66300-Z4S/ WV-X66300-Z3S

Image capture mode	Extension software	Stabilizer	SD recording	Smart coding	Super Dynamic	Intelligent auto	Privacy zone	Auto tracking
16:9(60/50fps)	No	Yes*1	No	Yes	No	Yes	Yes	No
16:9(30/25fps)	Yes	Yes*1	Yes	Yes	Yes	Yes	Yes	Yes
4:3(30/25fps)	Yes	Yes*1	Yes	Yes	Yes	Yes	Yes	Yes
4:3(15/12.5fps)	No	Yes*1	Yes	Yes	Yes	Yes	Yes	No

*1 When [Stabilizer] is set to [On], [Super Dynamic] setting is [Off].

5.3 DORI

WV-S66700-Z3LN/ WV-S66700-Z3N/ WV-S66700-Z3L/ WV-S66700-Z3/ WV-X66700-Z3LK/ WV-X66700-Z3K/ WV-X66700-Z3LS/ WV-X66700-Z3S

	WIDE	TELE
Detect (25 ppm/8 ppf)	127.8 m	3519.7 m
	419.3 ft	11547.6 ft
Observe (62.5 ppm/19 ppf)	51.1 m	1407.9 m
	167.7 ft	4619.0 ft
Recognize (125 ppm/38 ppf)	25.6 m	703.9 m
	83.9 ft	2309.5 ft
Identify (250 ppm/76 ppf)	12.8 m	352.0 m
	41.9 ft	1154.8 ft

WV-S66600-Z3LN/ WV-S66600-Z3N/ WV-S66600-Z3L/ WV-S66600-Z3/ WV-X66600-Z3LK/ WV-X66600-Z3K/ WV-X66600-Z3LS/ WV-X66600-Z3S

	WIDE	TELE
--	------	------

5. Specifications
 5.3 DORI

WV-S66600-Z3LN/ WV-S66600-Z3N/ WV-S66600-Z3L/ WV-S66600-Z3/ WV-X66600-Z3LK/ WV-X66600-Z3K/ WV-X66600-Z3LS/ WV-X66600-Z3S (continued)

Detect (25 ppm/8 ppf)	110.8 m	3050.4 m
	363.4 ft	10007.9 ft
Observe (62.5 ppm/19 ppf)	44.3 m	1220.2 m
	145.4 ft	4003.2 ft
Recognize (125 ppm/38 ppf)	22.2 m	610.1 m
	72.7 ft	2001.6 ft
Identify (250 ppm/76 ppf)	11.1 m	305.0 m
	36.3 ft	1000.8 ft

WV-S66300-Z4LN/ WV-S66300-Z4N/ WV-S66300-Z4L/ WV-S66300-Z4/ WV-X66300-Z4LK/ WV-X66300-Z4K/ WV-X66300-Z4LS/ WV-X66300-Z4S

	WIDE	TELE
Detect (25 ppm/8 ppf)	60.3 m	2199.9 m
	197.8 ft	7217.6 ft
Observe (62.5 ppm/19 ppf)	24.1 m	880.0 m
	79.1 ft	2887.1 ft
Recognize (125 ppm/38 ppf)	12.1 m	440.0 m
	39.6 ft	1443.5 ft
Identify (250 ppm/76 ppf)	6.0 m	220.0 m
	19.8 ft	721.8 ft

WV-S66300-Z3LN/ WV-S66300-Z3N/ WV-S66300-Z3L/ WV-S66300-Z3/ WV-X66300-Z3LK/ WV-X66300-Z3K/ WV-X66300-Z3LS/ WV-X66300-Z3S

	WIDE	TELE
Detect (25 ppm/8 ppf)	60.3 m	1833.2 m
	197.8 ft	6014.4 ft
Observe (62.5 ppm/19 ppf)	24.1 m	733.3 m
	79.1 ft	2405.8 ft
Recognize (125 ppm/38 ppf)	12.1 m	366.6 m
	39.6 ft	1202.9 ft
Identify (250 ppm/76 ppf)	6.0 m	183.3 m
	19.8 ft	601.4 ft

5.4 Streaming performance

- Up to 14 users are accessible at the same time.
- The maximum bandwidth is 50 Mbps.

5.5 About Available Extension software

Information about the number and capacity of Extension software (applications) that can be installed.

WV-S66700-Z3LN/ WV-S66700-Z3N/ WV-S66700-Z3L/ WV-S66700-Z3/ WV-S66600-Z3LN/ WV-S66600-Z3N/ WV-S66600-Z3L/ WV-S66600-Z3/ WV-X66700-Z3LK/ WV-X66700-Z3K/ WV-X66700-Z3LS/ WV-X66700-Z3S/ WV-X66600-Z3LK/ WV-X66600-Z3K/ WV-X66600-Z3LS/ WV-X66600-Z3S

Number of applications installed	Capacity of application (ROM capacity)	Appli capacity (RAM capacity)
3	153.6 MB	256 MB

WV-S66300-Z4LN/ WV-S66300-Z3LN/ WV-S66300-Z4N/ WV-S66300-Z3N/ WV-S66300-Z4L/ WV-S66300-Z3L/ WV-S66300-Z4/ WV-S66300-Z3/ WV-X66300-Z4LK/ WV-X66300-Z3LK/ WV-X66300-Z4K/ WV-X66300-Z3K/ WV-X66300-Z4LS/ WV-X66300-Z3LS/ WV-X66300-Z4S/ WV-X66300-Z3S

Number of applications installed	Capacity of application (ROM capacity)	Appli capacity (RAM capacity)
2	102.4 MB	153.6 MB



For the latest software (AI application) support status and restrictions, please check the technical information <Control No.: C0103> on our website.

→ [Technical information website](#)

Software name	Pre-installation	Support status
AI-VMD	Yes	Supported
AI Privacy Guard	No	Supported
AI Face Detection	No	Supported

Software name	Pre-installation	Support status
AI People Detection	Yes	Supported
AI Vehicle Detection	No	Supported
AI Non-Mask Detection	No	Supported
AI Occupancy Detection	No	Supported
AI Scene Change Detection	No	Supported

5.6 Lamp

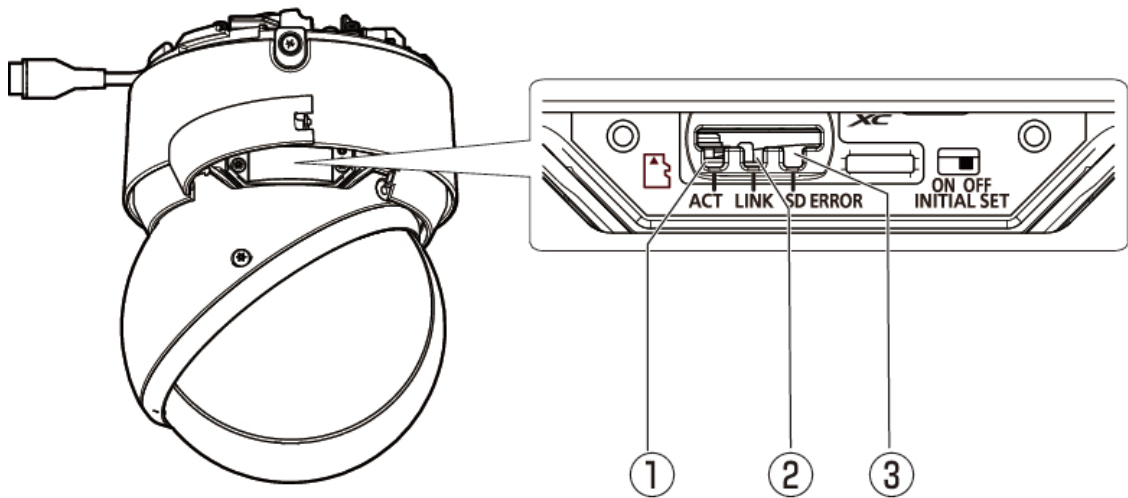

- ① ACT lamp (green)
- ② LINK lamp (orange)
- ③ SD ERROR lamp (red)

5.6.1 Lighting of the lamp

ACT lamp

When the camera sends and receives data

- Green LED is flashing (accessed)

LINK lamp

When communication with connected devices becomes possible

- Orange LED is ON

SD ERROR lamp

When an error condition is detected

※SD Memory Card Error Detection Conditions: Write error, read error, etc.

- Red ON



For more information about lamps, refer to the User Manual.

5.7 Button

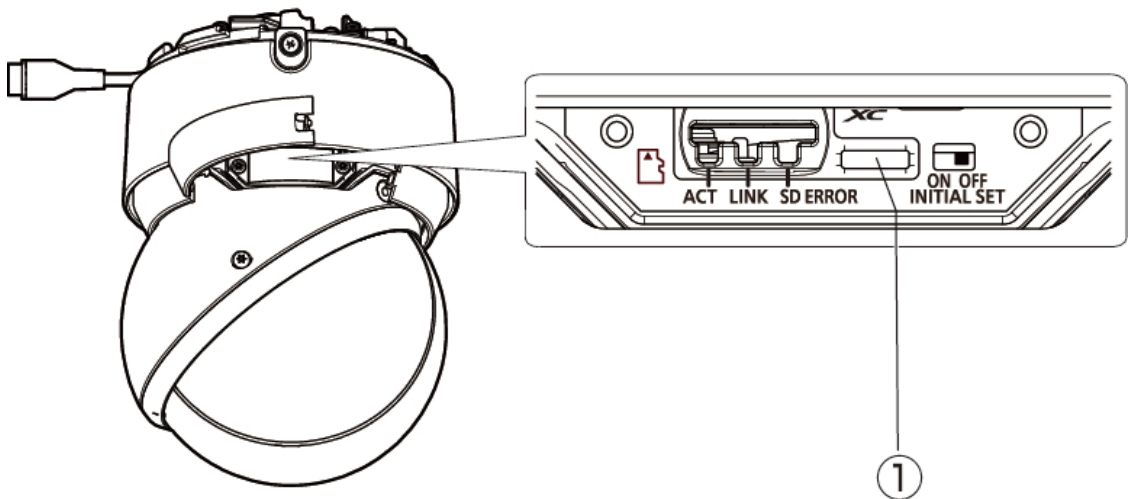

- ① INITIAL SET switch

5.8 Cable

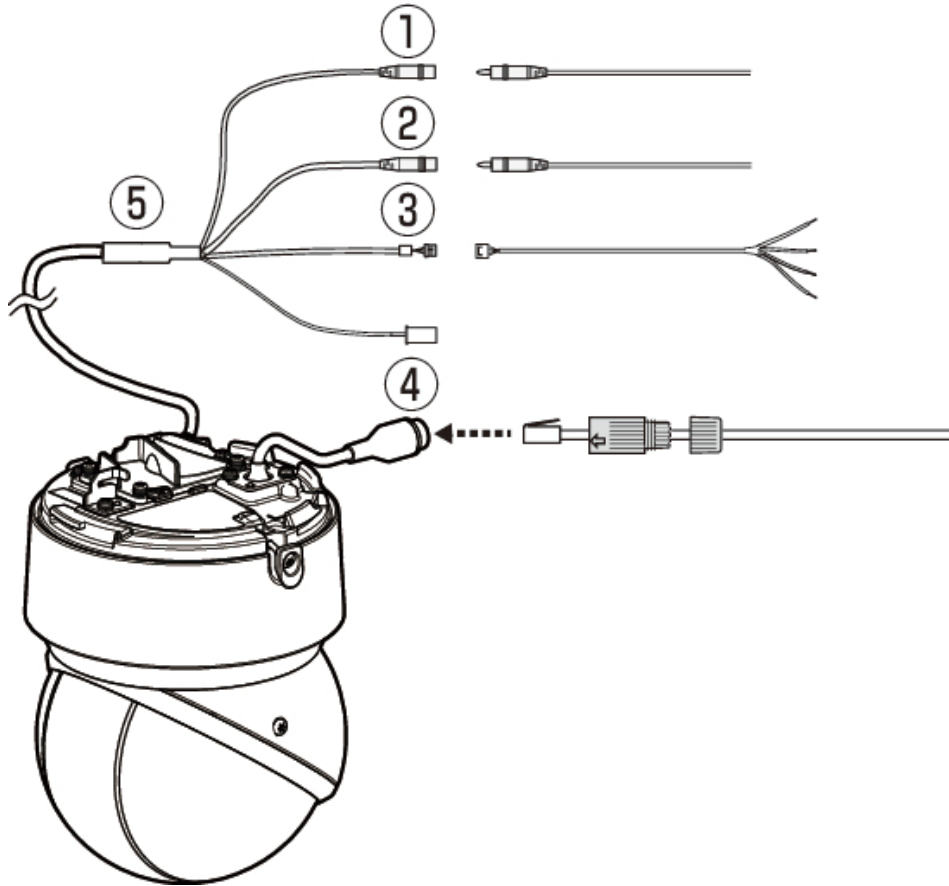

- ① Audio input cable (white)
- ② Audio output cable (black)
- ③ External I/O/4P Alarm Cable (WV-QCA501A accessory)
- ④ Ethernet cable with RJ45 plug (category 5e or better, straight, all 4 pairs (8 pins), less than 100m {328 feet})
- ⑤ I/O Cable WV-QCA501A (optional)



A detailed description of EXT I/O cable follows:

GND (Black)

ALARM IN1 (Green) : Alarm input 1/ Black & white input/ Auto time adjustment input

ALARM IN2 (Red) : Alarm input 2/ ALARM OUT

ALARM IN3 (Gray) : Alarm input 3/ ALARM OUT/ AUX OUT

Input specification : No-voltage make contact input (4 V – 5 V DC, internally pulled up resistor (approx. 5 k Ω))

OFF : Open or 4 V – 5 V DC

ON : Make contact with GND (required drive current: 1 mA or more)

Output specification : Open collector output (maximum applied voltage: 20 V DC)

OPEN : 4 V – 5 V DC, internally pulled up resistor (approx. 5 k Ω)

CLOSE : Output voltage 1 V DC or less (maximum drive current: 50 mA)

6. Other

6.1 Initialize

The INITIAL SET switch can be turned ON to initialize the body. For the position of the INITIAL SET switch, refer to the following.

→[Button](#)

1. Turn ON the INITIAL SET switch by moving it to the right.
2. Turn on the computer and wait about 15 seconds.
3. Move the [INITIAL SET] switch to the left to turn OFF.
 - Approximately two minutes later, the computer is started and the settings containing the network settings are initialized. If it does not start normally, try again.

6.2 Check the software version

The functions of this product are implemented in software. We recommend that you first check the current software version if there is a problem with the operation of this product.

➤ Live image pages configuration panels>[Detailed setting]>[Camera detailed setting]>[Maintenance] of the Advanced menus on the left>Clicking on the [Upgrade] tabs displays the versioning window.

1. Check software versions with [Firmware version]
 - The current software version can be checked.



Up-to-date versions of software may contain modifications to specific problems.

6.3 Upgrade software

➤ Live image pages configuration panels>[Detailed setting]>[Camera detailed setting]>[Maintenance] of the Advanced menus on the left>When the [Upgrade] tabs are clicked, the software-upgradeable window is displayed.

1. Download the latest software to the PC
2. Click Select Files to specify the software you downloaded, and then click [Execute].



- Use a PC on the same subnet as this product to upgrade the version.
- Do not turn off the power of this product during version upgrading. Do not perform any operation until the version upgrade is completed.
- Be sure to check the version after upgrading. Also, delete the temporary Internet file.

6.4 Order of setting when adjusting image quality

It is recommended to set the settings for image quality in the following order: Adjustment of visibility → Adjustment of color → Removal of noise.

1. Adjust the visibility
 - [Light control mode], [Intelligent auto], [Super Dynamic], [Contrast level], [High light compensation(HLC)], [Adaptive black stretch], [Adaptive highlight stretch], [Maximum gain], [Maximum shutter], [Pedestal level]
2. Adjust the color
 - [White balance], [Chroma gain level]
3. Remove the noise
 - [Digital noise reduction], [Sharpness level]



Refer to the User Manual for details of each function.



- The image quality adjustment function may affect each other.
- If necessary, adjust the brightness level of the screen.

6.5 Adjusting object brightness (bright scenes)

6.5.1 Adjusting brightness

Adjust the object brightness.

- Live image pages configuration panels>Clicking the [Image quality] tabs enables you to set the image quality.
- 1. Adjust the [Brightness] of [Image quality]
 - Moving in the [+] direction brightens the image.
 - Move in the [-] direction to darken the image.

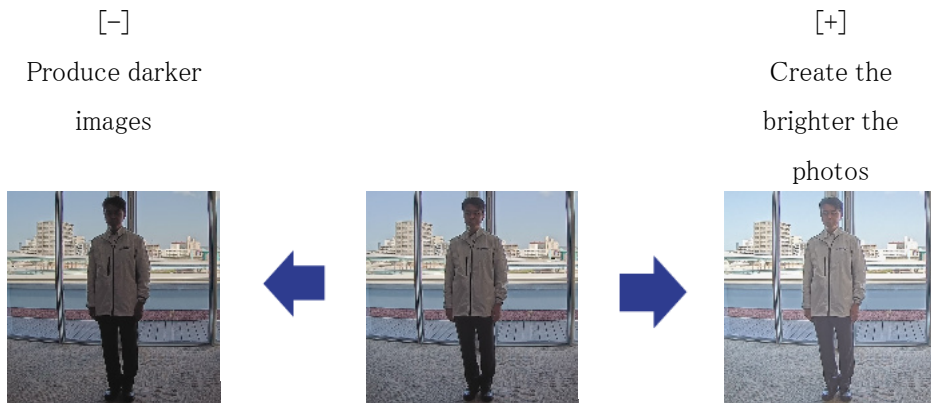

6.6 Adjusting object brightness (dark scenes)

6.6.1 Adjust the maximum gain

In dark scenes, the image becomes brighter by increasing the maximum gain.

- Live image pages configuration panels>Clicking the [Image quality] tabs enables you to set the image quality.
- 1. Adjust the [Maximum gain] to [+]

Maximum gain: 6

Maximum gain: 11

6. Other

6.7 Reducing white flickering and blacking on the screen

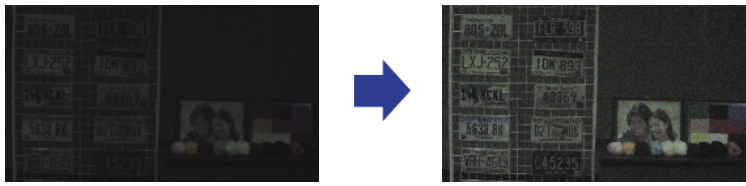

Increasing the maximum gain increases noise.

6.6.2 Adjust the maximum shutter

Increasing the maximum shutter makes the images brighter.

➤ Live image pages configuration panels>Clicking the [Image quality] tabs enables you to set the image quality.

1. Select [Maximum shutter]

- Selecting [Maximum shutter] longer than [Max 1/30s] brightens the image because the amount of light entered increases.



Increasing the maximum shutter increases the blur.

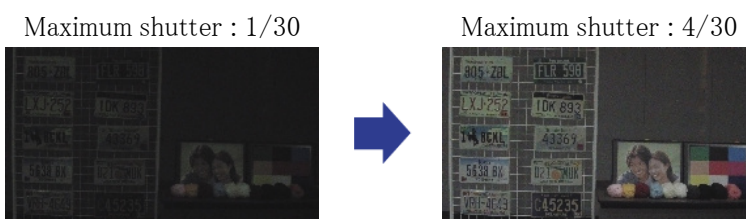

6.7 Reducing white flickering and blacking on the screen

6.7.1 Set Super Dynamic

When Super Dynamic is set to ON, both bright and dark areas are reproduced faithfully, even when shooting in a place with a large brightness difference.

6. Other

6.7 Reducing white flickering and blacking on the screen

- Live image pages configuration panels>Clicking the [Image quality] tabs enables you to set the image quality.

1. Set [Super Dynamic] to [On]



Set [Super Dynamic] to [Off] when the following phenomena are observed depending on the lighting condition.

- If flicker or color change occurs
- Noise in the bright area on the screen

Super Dynamic: Off



Super Dynamic: On



6.7.2 Set the backlight compensation

By setting [Backlight Corrector], the darkness of the indoor object is suppressed (brighter indoor object).

- Live image pages configuration panels>[Detail setting]>[Camera detailed setting]>[Image] or [Image/Audio] of the Advanced menus on the left>[Image adjust] in the [Image quality] tabs>When [Advanced settings] is clicked, the image quality adjustment setting window is displayed.

1. Set to [Back light compensation(BLC)] in the [Super Dynamic] [BLC/ HLC]



If [Super Dynamic] is set to [On] or [Intelligent Auto] is set to [On], [Backlight Compensation] cannot be set.

Back Light Correction: Off

Back light correction: On

Level: 16

6. Other

6.7 Reducing white flickering and blacking on the screen

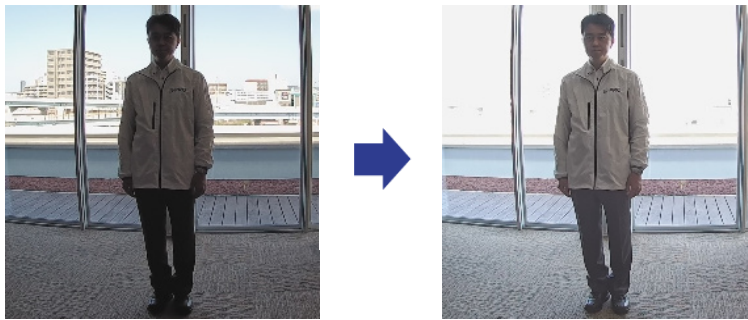

6.7.3 Set the high light compensation

By setting [High light compensation(HLC)], bright lights such as car headlights suppress the brightness of the object.

- Live image pages configuration panels>[Detailed setting]>[Camera detailed setting]>[Image] or [Image/Audio] of the Advanced menus on the left>[Image adjust] in the [Image quality] tabs>When [Setup] is clicked, the image quality adjustment setting window is displayed.

1. Select [High light compensation(HLC)] in [Super Dynamic]-[BLC/ HLC]



[High light compensation(HLC)] can be set only when Super Dynamic and Intelligent Auto are off.

High light compensation :

Off



High light compensation :

On



6.7.4 Adjust the adaptive black stretch

Adjust the [Adaptive black stretch] to brighten the dark areas of the images.

- Live image pages configuration panels>[Detail setting]>[Camera detailed setting]>[Image] or [Image/Audio] of the Advanced menus on the left>[Image adjust] in the [Image quality] tabs>When [Advanced settings] is clicked, the image quality adjustment setting window is displayed.

1. Adjust [Detail setting] [Adaptive black stretch] levels to [+]

6. Other

6.8 Adjust the object contrast

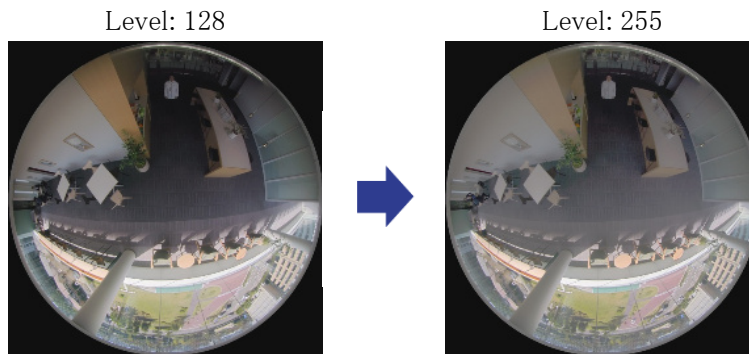

6.7.5 Adjust the [Pedestal level]

Adjust the [Pedestal level] to adjust the black level of the image.

- Live image pages configuration panels>[Detailed setting]>[Camera detailed setting]>[Image] or [Image/Audio] of the Advanced menus on the left>[Image adjust] in the [Image quality] tabs>When [Setup] is clicked, the image quality adjustment setting window is displayed.

1. Adjust the pedestal level of the [Detailed setting].

- Moving in the [+] direction brightens the image.
- Move in the [-] direction to darken the image.

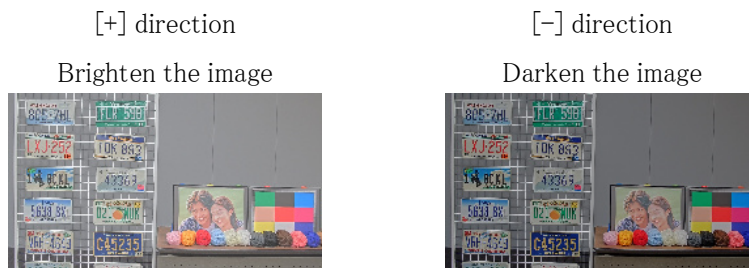

6.8 Adjust the object contrast

6.8.1 Adjust the contrast

By adjusting the [Contrast level] to increase the contrast between the light and dark images, visibility of the object with less contrast can be improved.

- Live image pages configuration panels>[Detailed setting]>[Camera detailed setting]>[Image] or [Image/Audio] of the Advanced menus on the left>[Image adjust] in the [Image quality]

6. Other

6.10 Reducing the blur of object (bright scenes)

tabs>When [Setup] is clicked, the image quality adjustment setting window is displayed.

1. Adjust [Detailed setting] [Contrast level] levels to [+]

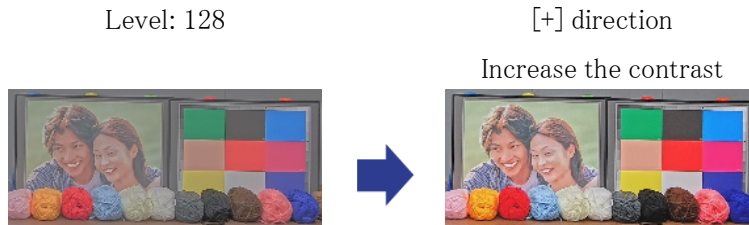

6.9 Reduce flicker

Flickers are automatically corrected by using [Light control mode].

- Live image pages configuration panels>Clicking the [Image quality] tabs enables you to set the image quality.

1. Select [Indoor scene (50 Hz)] or [Indoor scene (60 Hz)] for [Light control mode].
 - Use 50 Hz/60 Hz depending on the region.

6.10 Reducing the blur of object (bright scenes)

6.10.1 Set intelligent auto (motion priority level)

Using [Intelligent Auto], the camera identifies object with scenes (backlights, outdoors, night scenes, etc.) and facial movements of people. The camera automatically adjusts the amount, gain, shutter speed, and contrast of light entering the camera from the camera's lenses to make it easier to see a moving object.

- Live image pages configuration panels>[Detail setting]>[Camera detailed setting]>[Image] or [Image/Audio] of the Advanced menus on the left>[Image adjust] in the [Image quality] tabs>When [Advanced settings] is clicked, the image quality adjustment setting window is displayed.
1. Adjust [Face priority level (Brightness)] and [Motion priority level (Shutter)] with [Intelligent Auto] set to [On].
 - By adjusting in the [+] direction, blurring of the object will be reduced.

6. Other

6.10 Reducing the blur of object (bright scenes)



Increasing the level in a low illumination environment increases noise.

Off (person blurred)



On (less blurring)



6.10.2 Adjust the maximum shutter

Shortening the maximum shutter reduces blur.

➤ Live image pages configuration panels>Clicking the [Image quality] tabs enables you to set the image quality.

1. Selecting a shorter [Maximum shutter] than [Max. 1/30s]

- If [Maximum shutter] is set to a shorter time than [Max. 1/30s], blur is reduced.



In low illumination environments, shortening the maximum shutter will darken the object and increase the noise.

Maximum shutter :
1/30



Maximum shutter :
1/250



6.11 Reducing object blur (dark scenes)

6.11.1 Adjust digital noise reduction

Reducing the effects of noise reduction by adjusting the [Digital noise reduction] reduces the blur.

➤ Live image pages configuration panels>Clicking the [Image quality] tabs enables you to set the image quality.

1. Adjust the [Digital noise reduction] in the [-] direction.



If the effect of noise reduction is reduced, the noise will increase.

Level: 128



Level: 100

Reduce the blur



6.12 Sharpen the outline of the subject

6.12.1 Adjust the sharpness level

Adjust the [Sharpness level] to sharpen the outline of the images.

➤ Live image pages configuration panels>Clicking the [Image quality] tabs enables you to set the image quality.

1. Adjust the [Sharpness level] to [+]

Level: 10

Level: 31

Sharpen the outline of the image

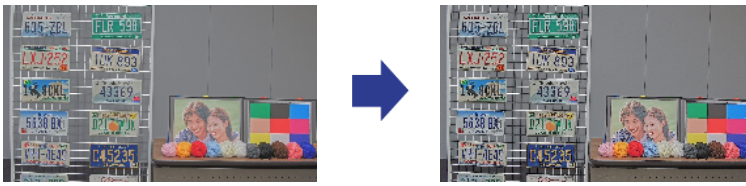

6.13 Adjust the color

6.13.1 Adjust color density

Adjust the [Chroma gain level] to adjust the darkness.

- Live image pages configuration panels>[Detailed setting]>[Camera detailed setting]>[Image] or [Image/Audio] of the Advanced menus on the left>[Image adjust] in the [Image quality] tabs>When [Setup] is clicked, the image quality adjustment setting window is displayed.

1. Adjust [Chroma gain level] in [Basic Adjustment] or [Detailed setting]
 - If you move the slider in the “+” direction, the colors will become loud and vivid.
 - If you move the slider in the “-” direction, the colors will become subdued.

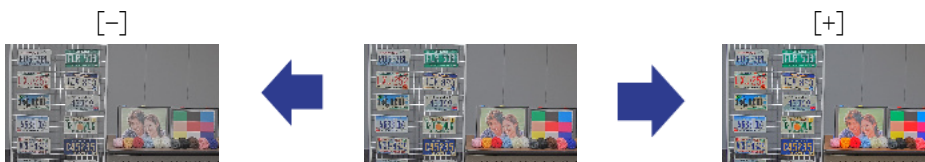

6.13.2 Adjust the white balance

If the color is affected by a sodium lamp, use [White balance] to adjust the color.

- Live image pages configuration panels>[Detailed setting]>[Camera detailed setting]>[Image] or [Image/Audio] of the Advanced menus on the left>[Image adjust] in the [Image quality] tabs>When [Setup] is clicked, the image quality adjustment setting window is displayed.

1. Select [ATW2] in [White balance]
 - The camera automatically adjusts the white balance under a sodium lamp.

Effect of sodium lamp

No effect of sodium lamp

6. Other

6.15 Reducing object noise (dark scenes)

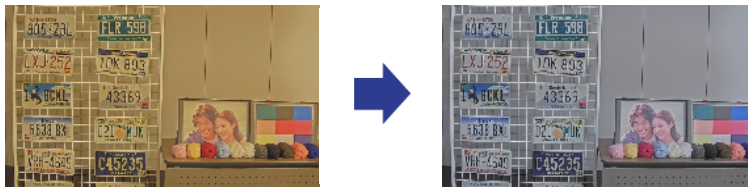

6.14 Reducing object noise (bright scenes)

6.14.1 Adjust the sharpness level

Adjusting the [Sharpness level] to make the images soft reduces the noise around the object.

➤ Live image pages configuration panels>Clicking the [Image quality] tabs enables you to set the image quality.

1. Adjust the [Sharpness level] in the [-] direction.

Level: 31

Level: 5

Soften the outline of the image



6.15 Reducing object noise (dark scenes)

6.15.1 Adjust digital noise reduction

By adjusting the [Digital noise reduction] and increasing the effects of noise reduction, noise is reduced.

➤ Live image pages configuration panels>Clicking the [Image quality] tabs enables you to set the image quality.

1. Adjust the [Digital noise reduction] to [+]



Increasing the effects of noise reduction increases blur.

Level: 90



Level: 255

Reduce noise



6.16 Troubleshooting

Check the symptoms on this table before asking for repair.

Contact the dealer from whom you purchased the watch if you do not recover from any of these problems or if you have symptoms other than those listed in this table.

Phenomenon	Cause	Countermeasures	Reference
Be not powered on	<p>For PoE++ power</p> <ul style="list-style-type: none"> •Does the PoE++ (IEEE802.3bt compliant) power supply and Ethernet cable of this equipment have a connection? •Some power supply devices that can connect multiple PoE++ terminal devices will not supply power if the total power supply exceeds the limit. 	<ul style="list-style-type: none"> •Check if it is connected. •Refer to the instruction manual for the PoE++ power supply. 	Installation

6. Other

6.16 Troubleshooting

Phenomenon	Cause	Countermeasures	Reference
The camera does not face the position set.	The camera may be out of orientation from the set position.	The position is corrected when position refresh is executed. When position refresh is set with the schedule function, the camera direction deviation can be corrected periodically. In some cases, reset the preset position.	User Manual
		Moving the preset in an environment below -40° C may cause displacement. PT can be improved by limiting the maximum panning/tilting speed. Eg, Maximum panning/tilting speed 50° /s	User Manual
Camera stops during PAN/TILT operation and machine sounds.	The camera may have been misaligned.	In the [Initialization] tabs of the Advanced menus, refresh the positions.	User Manual
Automatically rotate the camera	Noise may have an effect.	Check for external noise.	User Manual

6. Other

6.16 Troubleshooting

Phenomenon	Cause	Countermeasures	Reference
	Position refresh operation may be performed automatically to increase the position accuracy of PAN, TILT, and ZOOM at low temperature startup. However, this is not a failure.	—	—
The LINK lamp does not illuminate orange when the network cable is connected.	<ul style="list-style-type: none"> •Is the Ethernet cable connected correctly to the machine? •Is the hub or router to which the machine is connected working correctly? •Is the Ethernet cable connected to the machine broken? 	<ul style="list-style-type: none"> •Connect the Ethernet cable properly. •Check that your hub or router is working correctly. •Replace with another Ethernet cable. 	—
Camera operation noise is too loud.	This is improved by adjusting the camera operation speed.	Decrease the camera speed.	—
Generate noise in the audio input	The following may be considered.	If the peripheral is not improved, use a	Installation

6. Other
6.16 Troubleshooting

Phenomenon	Cause	Countermeasures	Reference
	<ul style="list-style-type: none"> •The grounding of the camera, switching hub, and peripheral equipment is not grounded. •Power lines, etc. are connected nearby. •There are equipment that generates strong electric and magnetic fields in the vicinity (such as television and radio transmission antennas, air conditioner motors, power transformers, etc.). 	microphone with an amplifier or connect an audio output with low output impedance.	
In rainy weather, the Dome covers are covered with rain grains and are visible on the image, making it difficult to see the site conditions.	The effectiveness of the rain wash coating may have been reduced. (ClearSight coating models only*)	Refer to “4.1 Cleaning of Dome cover” in “4. Clean up” and clean the dome cover. If the condition does not improve, contact your dealer. (ClearSight coating models only*)	—
	Removal of rain particles on the Dome covers may help.	Execute the Active ClearSight function to remove rain grains from the Dome covers easily.	
Incorrect auto focus (AF)	The focus may not be adjusted automatically in the following locations or object.	Adjust the focus manually from the top of the software screen.	—

6. Other

6.17 Precautions pertaining to usage

Phenomenon	Cause	Countermeasures	Reference
	<ul style="list-style-type: none">• There is a big move.• Large variation in illumination intensity• Low illuminance• Be extremely bright or reflective• Over windows• Locations where the Dome covers are prone to contamination.• White walls and other light and darkness are low.• Flashing is severe.		

- * <WV-S66700-Z3LN/ WV-S66700-Z3N/ WV-S66600-Z3LN/ WV-S66600-Z3N/
WV-S66300-Z4LN/ WV-S66300-Z3LN/ WV-S66300-Z4N/ WV-S66300-Z3N/
WV-X66700-Z3LK/ WV-X66700-Z3K/ WV-X66600-Z3LK/ WV-X66600-Z3K/
WV-X66300-Z4LK/ WV-X66300-Z3LK/ WV-X66300-Z4K/ WV-X66300-Z3K>
(ClearSight coating models only)

6.17 Precautions pertaining to usage

• Impact on image/image quality

Image quality may deteriorate or the image may be difficult to see under the installation conditions below.

- When raindrops adhere to the Dome covers during rainfall
- When snow adheres to the Dome covers due to wind during snow accumulation (the degree of snow adherence depends on the amount of snow fall and the snow quality)
- Contamination of the Dome covers due to airborne dust or automotive exhaust

• Do not apply strong shocks to the Dome covers.

Otherwise damage or flooding can result.

• Using in low temperature environments

This product is equipped with an internal heater unit for use in cold climates.

The heater unit turns on automatically when the temperature inside the product drops below around -10°C (14°F).

When this product is installed and operated in low temperatures below -20°C (-4°F), it may require time to start up since the camera will wait to be warmed up internally by the internal heater right after the power is turned on.

Also, the camera may not function properly, if it is installed and operated in an environment where the temperature is below -25°C (-13°F). In such a case, wait approximately 2 hours or more until the camera is warmed up. Then, turn on the power again.

As the camera warms up, snow or frost accumulated on the dome cover will melt. However, it may not be defrosted from the cover depending on the ambient temperature or weather condition.

- **When "WARMING UP-PLEASE WAIT" is displayed on the screen during use**

The inside temperature of this product is low. Wait for the interior to warm up before this product restarts automatically. Please wait for a while.

- **Do not touch the Dome covers.**

If dirty, image quality may deteriorate.

- **Advanced ClearSight Coating**

Due to the ClearSight Coating effects of the Dome covers, water drop may easily accumulate directly beneath the covers, and some of the images may be distorted.

<WV-S66700-Z3LN/ WV-S66700-Z3N/ WV-S66600-Z3LN/ WV-S66600-Z3N/
WV-S66300-Z4LN/ WV-S66300-Z3LN/ WV-S66300-Z4N/ WV-S66300-Z3N/
WV-X66700-Z3LK/ WV-X66700-Z3K/ WV-X66600-Z3LK/ WV-X66600-Z3K/
WV-X66300-Z4LK/ WV-X66300-Z3LK/ WV-X66300-Z4K/ WV-X66300-Z3K>
(ClearSight coating models only)

- **About the Active ClearSight function**

Images may be affected by raindrops on the Dome of the unit. In this case, it is possible to remove rain droplets by clicking the button on the screen and moving the horizontal (PAN) angle and the vertical (TILT) angle of the camera quickly. After removing the rain drops, the camera automatically performs position refresh to return to the original operation. This function removes raindrops easily and does not completely eliminate the raindrops in the Dome. During use of this function (approximately 20 seconds), PTZ operations will be disabled, camera images will be blurred vigorously, and the camera will emit an operation sound. Therefore, be careful not to record video or sound.

- **Batteries**

The battery is built into this product. Do not leave the battery in an environment exposed to excessive heat from sunlight or fire.

- **If this product is no longer in use, do not leave it unattended and must be removed.**

- **Consumables**

The following parts are consumables. Replace the watch with a new one based on the life time. The lifetime varies depending on the operating environment and conditions. The life time is a rough guide when used at +35 ° C.

- Lens, PAN motor, TILT motor, slip ring, TILT cable: About 3.7 million cycles (about 20,000 hours)

- * If the set position movement operation is continued for a long time, dust may accumulate on the slip ring. Position refresh can be prevented by periodically (about once a week) by setting a schedule.

For information about the slip ring of this product, refer to our technical information website <Control No.: C0125>.

- **Lens/turntable**

If the lens or the pan-tilt turntable is not operated for a long period of time, the viscosity of the grease applied to the inside may increase and the product may not move. Move the lens or pan-tilt rotating table periodically or refresh the position periodically.

- **Installation place**

The camera has heavy salt damage resistance treatment applied, but this does not ensure complete resistance against corrosion.

Please pay attention to the installation location such as in places where seawater does not splash directly.

Especially when installing this product in coastal areas and area that are sprayed with snow-melting agent that are not exposed to rainwater, periodically clean by rinsing to remove adhered salt.

Periodically inspect the camera when installing it in coastal areas or areas that are sprayed with snow-melting agent. (Replace parts as necessary.)

Prepare the foundation of the installation site, installation support, and any other installation setting with heavy salt damage resistance treatment.

<WV-X66700-Z3LK/ WV-X66700-Z3K/ WV-X66700-Z3LS/ WV-X66700-Z3S/
WV-X66600-Z3LK/ WV-X66600-Z3K/ WV-X66600-Z3LS/ WV-X66600-Z3S/
WV-X66300-Z4LK/ WV-X66300-Z3LK/ WV-X66300-Z4K/ WV-X66300-Z3K/
WV-X66300-Z4LS/ WV-X66300-Z3LS/ WV-X66300-Z4S/ WV-X66300-Z3S>

(Heavy salt damage resistance models only)

- **Installation place**

The product can not be installed in areas by the sea, the seashore, or where snow-melting agent is sprayed.

6. Other

6.17 Precautions pertaining to usage

<WV-S66700-Z3LN/ WV-S66700-Z3N/ WV-S66700-Z3L/ WV-S66700-Z3/ WV-S66600-Z3LN/ WV-S66600-Z3N/ WV-S66600-Z3L/ WV-S66600-Z3/ WV-S66300-Z4LN/ WV-S66300-Z3LN/ WV-S66300-Z4N/ WV-S66300-Z3N/ WV-S66300-Z4L/ WV-S66300-Z3L/ WV-S66300-Z4/ WV-S66300-Z3>

(Normal models only)

• **Open Source Software**

- This product contains open source software licensed under GPL (GNU General Public License), LGPL (GNU Lesser General Public License), etc.
- Customers can duplicate, distribute and modify the source code of the software under license of GPL and/or LGPL.
- For details concerning licensing and source code of open source software, click “Click here for OSS information” on “Support” page of the setup menu of this product and read the displayed content.
- Please note that we shall not respond to any inquiries regarding the contents of the source code.

• **Copyright**

Except for open source software licensed under GPL/LGPL and so on, distributing, copying, disassembling, reverse compiling and reverse engineering of the software provided with this product are all expressly prohibited. In addition, exporting any software provided with this product violating export laws is prohibited.

• **For trademarks and registered trademarks**

- Microsoft, Windows, Windows Media, Internet Explorer, Microsoft Edge, and ActiveX are either registered trademarks or trademarks of Microsoft Corporation in the United States and/or other countries.
- Intel and Intel Core are trademarks of Intel Corporation or its subsidiaries in the United States and/or other countries.
- Adobe, Acrobat, and Reader are either registered trademarks or trademarks of Adobe in the United States and/or other countries.
- The microSDXC Logo is a trademark of SD-3C, LLC.
- iPad and iPhone are trademarks of Apple Inc. registered in the United States and other countries.
- Android and Google Chrome are trademarks of Google LLC.
- Firefox is a trademark of the Mozilla Foundation in the United States and other countries.
- Other company names and product names described in this manual are trademarks or registered trademarks of each company. All other trademarks identified herein are the property of their respective owners.

6.18 Disclaimer

IN NO EVENT SHALL i-PRO Co., Ltd. BE LIABLE TO ANY PARTY OR ANY PERSON, EXCEPT FOR REPLACEMENT OR REASONABLE MAINTENANCE OF THE PRODUCT, FOR THE CASES, INCLUDING BUT NOT LIMITED TO BELOW:

1. ANY LOSS OR DAMAGE, INCLUDING WITHOUT LIMITATION, DIRECT OR INDIRECT, SPECIAL, CONSEQUENTIAL OR EXEMPLARY, ARISING OUT OF OR RELATING TO THE PRODUCT;
2. ANY INCONVENIENCE, LOSS, OR DAMAGE CAUSED BY INAPPROPRIATE USE OR NEGLIGENT OPERATION OF THE USER;
3. ALL MALFUNCTIONS OR TROUBLES FROM UNAUTHORIZED DISASSEMBLE, REPAIR OR MODIFICATION OF THE PRODUCT BY THE USER, REGARDLESS OF THE CAUSE OF THE MALFUNCTION OR TROUBLE;
4. INCONVENIENCE OR ANY LOSS ARISING WHEN IMAGES ARE NOT DISPLAYED, DUE TO ANY REASON OR CAUSE INCLUDING ANY FAILURE OR PROBLEM OF THE PRODUCT;
5. ANY PROBLEM, CONSEQUENTIAL INCONVENIENCE, OR LOSS OR DAMAGE, ARISING OUT OF THE SYSTEM COMBINED BY THE DEVICES OF THIRD PARTY;
6. ANY CLAIM OR ACTION FOR DAMAGES BROUGHT BY ANY PERSON OR ORGANIZATION AS A PHOTOGRAPHED SUBJECT DUE TO VIOLATION OF PRIVACY CONCERNING A SURVEILLANCE CAMERA'S PICTURE OR SAVED DATA, FOR SOME REASON (INCLUDING USE WHEN USER AUTHENTICATION ON THE AUTHENTICATION SETTING SCREEN IS SET TO OFF), BECOMING PUBLIC OR BEING USED FOR ANY PURPOSE;
7. LOSS OF REGISTERED DATA CAUSED BY ANY FAILURE (INCLUDING INITIALIZATION OF THE PRODUCT DUE TO FORGOTTEN AUTHENTICATION INFORMATION SUCH AS A USER NAME AND PASSWORD);

Limitation of liability

THIS PUBLICATION IS PROVIDED "AS IS" WITHOUT WARRANTY OF ANY KIND, EITHER EXPRESS OR IMPLIED, INCLUDING BUT NOT LIMITED TO, THE IMPLIED WARRANTIES OF MERCHANTABILITY, FITNESS FOR ANY PARTICULAR PURPOSE, OR NON-INFRINGEMENT OF THE THIRD PARTY'S RIGHT.

THIS PUBLICATION COULD INCLUDE TECHNICAL INACCURACIES OR TYPOGRAPHICAL ERRORS. CHANGES ARE ADDED TO THE INFORMATION HEREIN, AT ANY TIME, FOR

THE IMPROVEMENTS OF THIS PUBLICATION AND/OR THE CORRESPONDING PRODUCT (S).

6.19 NETWORK RELATIONSHIP

Since this product is connected to the network, it may be damaged as follows.

- ① Leakage or leakage of information via this product
- ② Malicious operation of this product by a malicious third party
- ③ Interference or stoppage of this product by a malicious third party

In order to prevent such damage, take adequate network security measures including the following measures under the responsibility of the customer.

- Use this product on a secure network using firewalls, etc.
- Confirm that computer viruses and malicious programs are regularly checked and exterminated when the computer is connected to the system.
- Use user authentication, set user names and passwords, and restrict users who can log in to protect against unauthorized attacks.
- To prevent image data, authentication information (user name, password), alarm mail information, FTP server information, DDNS server information, etc., from being leaked on the network, measures such as restricting access by user authentication are implemented.
- All browsers must be closed after administrator access to this product.
- The password of the administrator is changed periodically. In addition, authentication information (user name, password) shall be appropriately stored so that it is not visible to third parties.
- Do not install this product or cables in a place where they are easily destroyed.