



User manual

Network cameras

Contents

| | | |
|----------|----------------------------------------------------------------------------|-----------|
| 1 | Introduction | 1 |
| | 1.1 About User Manuals | 1 |
| | 1.2 Compatible models and symbols in this manual | 1 |
| | 1.3 Abbreviation | 16 |
| | 1.4 Disclaimer | 16 |
| | 1.5 For trademarks and registered trademarks | 17 |
| | 1.6 NETWORK RELATIONSHIP | 17 |
| | 1.7 Instructions for use | 18 |
| 2 | Operation | 22 |
| | 2.1 Initial Setting | 22 |
| | 2.2 Initial setting (Multi-directional/PTZ integrated camera) | 27 |
| | 2.3 Viewing images from a PC | 32 |
| | 2.3.1 View camera images | 33 |
| | 2.3.2 About live image pages | 47 |
| | 2.3.3 Monitor images from multiple cameras | 82 |
| | 2.4 Viewing images from mobile/tablet terminals | 84 |
| | 2.4.1 Viewing images from mobile devices (smartphones, etc.) | 84 |
| | 2.4.2 View images from a tablet terminal | 105 |
| | 2.5 Manually save images on the SD memory card | 131 |
| | 2.6 Operation when alarm is generated | 132 |
| | 2.6.1 Alarm type | 132 |
| | 2.6.2 Operation when alarm is generated | 133 |
| | 2.7 Display the log list | 134 |
| | 2.8 Play back images on the SD Memory Card | 138 |
| | 2.8.1 When playing JPEG images stored on the SD Memory Card | 139 |
| | 2.8.2 Play back the image of the stream stored on the SD Memory Card | 141 |

| | | |
|----------|---------------------------------------------------------------------------------------------------|------------|
| 3 | Setting | 146 |
| 3.1 | Displaying the configuration panel from the PC | 146 |
| 3.1.1 | How to display | 146 |
| 3.1.2 | How to operate | 147 |
| 3.1.3 | Setting Panel Screen | 147 |
| 3.2 | [Basic] to perform basic settings | 149 |
| 3.3 | [Stream] for setting images | 151 |
| 3.4 | [Image quality] for setting image quality | 152 |
| 3.5 | [Zoom] for setting EX zoom | 154 |
| 3.6 | [Zoom] for setting EX optical zoom | 155 |
| 3.7 | [Zoom] for set zoom/focus | 155 |
| 3.8 | [Audio] for setting sound | 156 |
| 3.9 | [Alarm] to set alarm | 157 |
| 3.10 | [Detailed setting] for switching to advanced settings and setting related to the displayed images | 159 |
| 4 | About network security | 161 |
| 4.1 | Security function of the unit | 161 |
| 5 | Displaying the camera settings menu from the PC | 163 |
| 5.1 | How to display | 163 |
| 5.2 | How to operate | 164 |
| 5.3 | Camera Advanced Menu Screen | 165 |
| 6 | [Ext. software] for managing and scheduling advanced software | 169 |
| 6.1 | [Software mng.] for installing, uninstalling, and upgrading function extension software | 169 |
| 6.2 | [Operation sched.] for scheduling extended software | 177 |
| 6.3 | [Control log] to check the [Control log] of the function extension software | 180 |
| 7 | [Easy Setup] to use easy setting | 182 |
| 7.1 | [Easy installation] where easy installation is performed | 182 |
| 7.2 | [Internet] to set up an Internet-based disclosure system | 185 |

| | | |
|----------|--------------------------------------------------------------------------------------------------|------------|
| 7.3 | [Event action] for setting events | 193 |
| 7.3.1 | Schedule/alarm setting (event type setting screen) | 196 |
| 7.3.2 | Alarm: Sets terminal and operation detection (alarm setting screen) | 197 |
| 7.3.3 | Alarm: Sets operation condition (Alarm type setting screen) | 202 |
| 7.3.4 | Alarm: Setting details of image transfer or recording conditions | 204 |
| 7.3.5 | Alarm: Sets output terminal. | 208 |
| 7.3.6 | Alarm: Configuring mail notification and mail server | 209 |
| 7.3.7 | Schedule: Set SD recording or FTP/SFTP periodic transmission (Schedule type setting screen) | 211 |
| 7.3.8 | Schedule: Set SD recording (Movie recording setting screen) | 212 |
| 7.3.9 | Schedule: Setting FTP/SFTP Periodic Transmission (FTP/SFTP Periodic Transmission Setting Screen) | 216 |
| 8 | [Basic] for basic setup of the machine | 221 |

| | | |
|----------|---------------------------------------------------------|------------|
| 8.1 | [Basic] to perform basic settings | 221 |
| 8.2 | [SD memory card] for setting SD Memory Cards | 230 |
| 8.3 | [Alteration detection] for detecting tampering | 242 |
| 8.4 | How to set up falsification detection | 245 |
| 8.5 | [Overlay image] to set overlays | 245 |
| 9 | [Image/Audio] for setting images and sound files | 251 |

| | | |
|-------|---------------------------------------------------------------|-----|
| 9.1 | [Image] to set the imaging modes | 251 |
| 9.2 | [Image] for setting JPEG images | 254 |
| 9.3 | [Image] for setting up streams | 262 |
| 9.4 | [Image quality] to set the image quality | 278 |
| 9.4.1 | To adjust the image quality (image quality adjustment screen) | 282 |
| 9.4.2 | Set the mask area | 296 |
| 9.4.3 | Adjust the angle of view with the EX zoom | 299 |
| 9.4.4 | Adjust the angle of view with the Ex optical zoom | 300 |
| 9.4.5 | Adjust the zoom/focus | 301 |
| 9.4.6 | Setting the privacy zone (Privacy zone setting screen) | 306 |
| 9.4.7 | Set up VIQS | 313 |
| 9.4.8 | Set up the VIQS area | 321 |
| 9.4.9 | Set the lens distortion compensation | 323 |
| 9.5 | [Audio] for setting sound | 324 |

| | | |
|-----------|----------------------------------------------------------------------------------------------------|------------|
| 10 | Set PTZ | 328 |
| 10.1 | [Cam. Function] for setting the operation of cameras | 328 |
| 10.1.1 | [Cam. Function] for setting the operation of Rapid PTZ Cameras, Multi-directional + PTZ (PTZ part) | 329 |
| 10.1.2 | [Cam. Function] for setting the operation of Indoor PTZ cameras | 334 |
| 10.2 | [Position] for setting positions | 338 |
| 10.2.1 | Set the preset position (preset position setting screen) | 339 |
| 10.2.2 | Set the preset sequence setting (preset sequence setting screen) | 344 |
| 10.2.3 | Set auto pan (Auto pan setting screen) | 346 |
| 10.2.4 | Set patrol (Patrol function setting screen) | 350 |
| 10.2.5 | Setting for direction/direction setting (direction/direction setting screen) | 351 |
| 10.2.6 | Setting of pan/tilt range (pan/tilt range setting screen) | 354 |
| 10.3 | Set auto-tracking (Auto-tracking screen) | 356 |
| 10.4 | Set Auto Track Alarm (Auto Track Alarm screen) | 362 |
| 11 | Configure the multi-screen settings[Multi-screen] | 365 |
| 12 | [Alarm] to set the alarm | 367 |
| 12.1 | [Alarm] to set alarm operation | 367 |
| 12.2 | [Alarm] for setting the output terminal | 371 |
| 12.3 | [Alarm] to change the aux name | 373 |
| 12.4 | [Alarm] to set alarm linkage operation | 373 |
| 12.4.1 | Set the preset position by source (screen for setting preset position by source) | 377 |
| 12.4.2 | Mail sending when an alarm is generated | 378 |
| 12.4.3 | Set up FTP/SFTP transmission when an alarm is generated | 378 |
| 12.4.4 | Sets recording data to SD Memory Card when alarm is generated. | 380 |
| 12.4.5 | Sets unique alarm notification when an alarm is generated. | 380 |
| 12.4.6 | Sets HTTP alarm notification when an alarm is generated. | 380 |
| 12.4.7 | Set SNMP transmission when an alarm is generated. | 380 |
| 12.5 | [VMD area] for setting motion detection | 380 |
| 12.6 | [VMD area] to set the motion detection area | 391 |
| 12.7 | [SCD area] to set up undesired detection | 393 |
| 12.8 | [SCD area] to set up undesired detection areas | 395 |

| | | |
|-----------|-------------------------------------------------------------|------------|
| 12.9 | [Audio detection] for setting sound detection | 399 |
| 12.10 | [Impact detection] for setting impact detection | 401 |
| 12.11 | [Casing open detection] for setting opening detection | 404 |
| 12.12 | [Notification] to set alarm notification | 406 |
| 12.12.1 | Set unique alarm notification | 406 |
| 12.12.2 | Set the HTTP alarm notification | 409 |
| 13 | [User mng.] to set authentication | 412 |
| <hr/> | | |
| 13.1 | [User auth.] to configure user-authentication | 412 |
| 13.2 | [Host auth.] to configure host-authentication | 415 |
| 13.3 | [System] to set preference streams | 416 |
| 13.4 | [IEEE 802.1X] to configure IEEE 802.1X | 417 |
| 13.5 | [Data encryption] for setting up data encryption | 423 |
| 13.6 | [Security] to configure security | 428 |
| 14 | Networking configuration [Network] | 430 |
| <hr/> | | |
| 14.1 | Networking [Network] | 430 |
| 14.2 | [Advanced] for advanced networking settings | 435 |
| 14.2.1 | Set mail sending | 436 |
| 14.2.2 | Configuring FTP/SFTP transmission function | 441 |
| 14.2.3 | Set up an NTP server | 452 |
| 14.2.4 | Set UPnP | 454 |
| 14.2.5 | Set up HTTPS | 455 |
| 14.2.6 | Set up DDNS | 458 |
| 14.2.7 | Set SNMP | 458 |
| 14.2.8 | Set QoS | 464 |
| 14.2.9 | Configure SRTP | 464 |
| 14.2.10 | Set MQTT | 465 |
| 14.2.11 | Configure LLDP | 467 |
| 14.3 | Setting up HTTPS | 469 |
| 14.3.1 | How to generate a signing request (CSR) | 469 |
| 14.4 | How to configure DDNS | 471 |
| 14.4.1 | With [Viewnetcam.com] services | 473 |
| 14.4.2 | Using Dynamic DNS Update (without DHCP) | 476 |
| 14.4.3 | Using Dynamic DNS Update | 476 |

| | | |
|----------------------------|-------------------------------------------------------------------------|------------|
| 14.5 | Use Remote Monitoring | 477 |
| 15 | [Schedule] for scheduling | 483 |
| <hr/> | | |
| 15.1 | How to set the schedule | 489 |
| 15.2 | How to Delete Schedule | 492 |
| 15.3 | How to change the image quality based on the time of sunrise/sunset ... | 494 |
| 16 | [Maintenance] to maintain the machine | 496 |
| <hr/> | | |
| 16.1 | [System log] to check the system logs | 496 |
| 16.2 | [Upgrade] to upgrade the software | 497 |
| 16.3 | [Status] for checking the status | 499 |
| 16.4 | [Default reset] to initialize and restart the computer | 505 |
| 16.5 | [Data] to back up/restore configuration logs | 506 |
| 17 | Viewing Our Support Website [Support] | 508 |
| <hr/> | | |
| 18 | Other | 509 |
| <hr/> | | |
| 18.1 | System Log Display | 509 |
| 18.2 | Trouble!?! | 514 |
| 18.3 | Directory structure of SD Memory Card | 524 |
| 18.3.1 | Directories of PTZ Camera, Fixed cameras | 524 |
| 18.3.2 | Directory Configuration of Multi-directional Camera | 525 |
| 19 | Change history | 526 |
| <hr/> | | |
| Ver 1.000.000 (2023.02.15) | | 526 |
| Ver 1.001.000 (2023.03.08) | | 526 |
| Ver 1.002.000 (2023.09.12) | | 526 |
| Ver 1.003.000 (2023.09.29) | | 527 |
| Ver 1.004.000 (2023.12.15) | | 527 |
| Ver 1.005.000 (2023.12.26) | | 528 |
| Ver 1.006.000 (2024.02.27) | | 528 |
| Ver 1.007.000 (2024.03.18) | | 528 |
| Ver 1.008.000 (2024.05.27) | | 528 |
| Ver 1.009.000 (2024.05.28) | | 529 |
| Ver 1.010.000 (2024.08.06) | | 529 |

Ver 1.011.000 (2024.10.24) 529
Ver 1.012.000 (2024.10.31) 529

1 Introduction

1.1 About User Manuals

This manual describes the operation and setting methods of the software that runs this machine. The description of the camera screen and function used in this manual is not limited to a specific model, but includes various cameras. Therefore, the description screen and camera screen may differ depending on the model you use.

This manual explains how to operate and configure a camera using a web browser. For camera settings, we recommend using the i-PRO setup tool (iCT). By using the i-PRO Setup Tool (iCT), you can configure up to 1024 cameras simultaneously and you can efficiently configure the cameras. For the i-PRO Configuration Tool, please refer to our Technical Information Website <Control No. C0133>.



[Note:]

- Refer to the catalog specifications for the functions installed in each model.
- [used] in this document [<Control number: Cxxxx>] is the number used to search for the relevant information in our technical information website.
https://i-pro.com/products_and_solutions/en/surveillance/learning-and-support/knowledge-base/technical-information
- Screen photographs are used according to the guidelines of Microsoft Corporation.
- This document describes the operation when using the Japanese version of Google Chrome as a representative. For confirmation of the operation of the corresponding Web browser, please refer to our Technical Information Web site <Control No.: C0132>.

1.2 Compatible models and symbols in this manual

The corresponding models in this manual are described in the model column in the table below. The functions restricted by this manual refer to the models that can be used with the following symbols and terminology. Functions for which this symbol is not used are supported by all models.

1 Introduction

1.2 Compatible models and symbols in this manual

| Symbol | Term | Model |
|-------------|------------------|-----------------------------------------------------------------------------------------------------------------------------------------------------------------------------------------------------------------------------------------------------------------------------------------------------------------------------------------------------------------------------------------------------------------------------------------------------------------------------------------------------------------------------------------------------------------------------------------------------------------------------------------------|
| [PTZ] | PTZ cameras | WV-X86531-Z2(PTZ part), WV-X86531-Z2-1(PTZ part), WV-X86530-Z2(PTZ part), WV-X86530-Z2-1(PTZ part), WV-S66700-Z3L、WV-X66700-Z3LS、WV-S66700-Z3、WV-X66700-Z3S、 WV-S66700-Z3LN、WV-X66700-Z3LK、WV-S66700-Z3N、WV-X66700-Z3K、 WV-S61702-Z3、WV-S66600-Z3L、WV-X66600-Z3LS、WV-S66600-Z3、WV-X66600-Z3S、WV-S66600-Z3LN、WV-X66600-Z3LK、WV-S66600-Z3N、 WV-X66600-Z3K、WV-S61602-Z3、WV-S66300-Z4L、WV-X66300-Z4LS、 WV-S66300-Z3L、WV-X66300-Z3LS、WV-S66300-Z4、WV-X66300-Z4S、 WV-S66300-Z3、WV-X66300-Z3S、WV-S66300-Z4LN、WV-X66300-Z4LK、 WV-S66300-Z3LN、WV-X66300-Z3LK、WV-S66300-Z4N、WV-X66300-Z4K、 WV-S66300-Z3N、WV-X66300-Z3K |
| [Rapid PTZ] | Rapid PTZ Camera | WV-S66700-Z3L、WV-X66700-Z3LS、WV-S66700-Z3、WV-X66700-Z3S、 WV-S66700-Z3LN、WV-X66700- |

1 Introduction

1.2 Compatible models and symbols in this manual

| | | |
|--------------------|-------------------------------------------------------------|-----------------------------------------------------------------------------------------------------------------------------------------------------------------------------------------------------------------------------------------------------------------------------------------------------------------------------------------------------------------------------------------------------------------------------------------------|
| | | <p>Z3LK、WV-S66600-Z3L、WV-X66600-Z3LS、 WV-S66600-Z3、WV-X66600-Z3S、 WV-S66600-Z3LN、WV-X66600-Z3LK、 WV-S66300-Z4L、WV-X66300-Z4LS、WV-S66300-Z4LN、WV-X66300-Z4LK、 WV-S66300-Z3L、WV-X66300-Z3LS、WV-S66300-Z3LN、WV-X66300-Z3LK、 WV-S66700-Z3N、WV-X66700-Z3K、WV-S66600-Z3N、WV-X66600-Z3K、 WV-S66300-Z4、WV-X66300-Z4S、 WV-S66300-Z3、WV-X66300-Z3S、 WV-S66300-Z4N、WV-X66300-Z4K、WV-S66300-Z3N、WV-X66300-Z3K</p> |
| [Rapid PTZ-8M(4K)] | Rapid PTZ cameras (X/S series, Image capture size: 8M (4K)) | <p>WV-S66700-Z3L、WV-X66700-Z3LS、WV-S66700-Z3、WV-X66700-Z3S、 WV-S66700-Z3LN、WV-X66700-Z3LK、WV-S66700-Z3N、WV-X66700-Z3K</p> |
| [Rapid PTZ-6M] | Rapid PTZ Camera(X/S Series, Image capture size: 6MP) | <p>WV-S66600-Z3L、WV-X66600-Z3LS、WV-S66600-Z3、WV-X66600-Z3S、 WV-S66600-Z3LN、WV-X66600-Z3LK、WV-S66600-Z3N、WV-X66600-Z3K</p> |

1 Introduction

1.2 Compatible models and symbols in this manual

| | | |
|---------------------|-------------------------------------------------------|-----------------------------------------------------------------------------------------------------------------------------------------------------------------------------------------------------------------------------------------------------|
| [Rapid PTZ-2M] | Rapid PTZ Camera(X/S Series, Image capture size: 2MP) | WV-S66300-Z4L、WV-X66300-Z4LS、WV-S66300-Z3L、WV-X66300-Z3LS、 WV-S66300-Z4、WV-X66300-Z4S、 WV-S66300-Z3、WV-X66300-Z3S、 WV-S66300-Z4LN、WV-X66300-Z4LK、WV-S66300-Z3LN、WV-X66300-Z3LK、 WV-S66300-Z4N、WV-X66300-Z4K、WV-S66300-Z3N、WV-X66300-Z3K |
| [Indoor PTZ] | Indoor PTZ cameras | WV-S61702-Z3、WV-S61602-Z3 |
| [Indoor PTZ-8M(4K)] | Indoor PTZ cameras (Image capture size: 8M (4K)) | WV-S61702-Z3 |
| [Indoor PTZ-6M] | Indoor PTZ cameras (Image capture size: 6MP) | WV-S61602-Z3 |
| [MULTI] | Multi-directional cameras | WV-X86531-Z2(Multi part)、 WV-X86531-Z2-1(Multi part)、 WV-X86530-Z2(Multi part)、 WV-X86530-Z2-1(Multi part)、 WV-S85702-F3L、WV-S85702-F3L1、WV-S85402-V2L、WV-S85402-V2L1、 WV-U85402-V2L、WV-U85402-V2L1 |
| [MULTI4] | Multi-directional cameras (4 eyes) | WV-X86531-Z2(Multi part)、 X86531-Z2-1(Multi part) |
| [MULTI3] | Multi-directional cameras (3 eyes) | WV-X86530-Z2(Multi part)、 WV-X86530-Z2-1(Multi part) |
| [MULTI2] | Multi-directional cameras (2 eyes) | WV-S85702-F3L、WV-S85702-F3L1、WV-S85402-V2L、WV-S85402-V2L1、 WV-U85402-V2L、WV-U85402-V2L1 |

1 Introduction

1.2 Compatible models and symbols in this manual

| | | |
|-------------|--------------------------------------------|--------------------------------------------------------------------------------------------------------------------------------------------------------------------------------------------------------------------------------------------------------------------------------------------------------------------------------------------------------------------------------------------------------------------------------------|
| [MULTI2S] | Multi-directional cameras (2-eye S-series) | WV-S85702-F3L、WV-S85702-F3L1、WV-S85402-V2L、WV-S85402-V2L1 |
| [MULTI2U] | Multi-directional cameras (2-eye U-series) | WV-U85402-V2L、WV-U85402-V2L1 |
| [MULTI_PTZ] | Multi-directional + PTZ | WV-X86531-Z2(PTZ part)、 WV-X86531-Z2-1(PTZ part)、 WV-X86530-Z2(PTZ part)、 WV-X86530-Z2-1(PTZ part)、 WV-X86531-Z2(Multi part)、 WV-X86531-Z2-1(Multi part)、 WV-X86530-Z2(Multi part)、 WV-X86530-Z2-1(Multi part) |
| [Fixed] | Fixed cameras | WV-X35402-F2LM、WV-X35302-F2LM、WV-X35402-F2L、WV-X35302-F2L、 WV-S35402-F2L、WV-S35402-F2LG、WV-S35402-F2L1、WV-S32402-F2L、 WV-S32402-F2LG、WV-S32402-F2L1、WV-S35302-F2L、WV-S35302-F2LG、 WV-S35302-F2L1、WV-S32302-F2L、WV-S32302-F2LG、WV-S32302-F2L1、 WV-U35401-F2L、WV-U35401-F2LG、WV-U35301-F2L、WV-U35301-F2LG、 WV-U31401-F2L、WV-U31401-F2LG、WV-U31301-F2L、WV-U31301-F2LG、 WV-X15300-V3L、WV-X15300-V3LN、WV-X22300-V3L、WV- |

1 Introduction

1.2 Compatible models and symbols in this manual

| | | |
|------------|---------------------------------|----------------------------------------------------------------------------------------------------------------------------------------------------------------------------------------------------------------------------------------------------------------------------------------------------------------------------------------------------------------------------------------------------------------------|
| | | <p>X25300-V3LN, WV-X15500-V3L, WV-X15500-V3LN, WV-X22500-V3L, WV-X25500-V3LN, WV-X15600-V2L, WV-X15600-V2LN, WV-X22600-V2L, WV-X25600-V2LN, WV-X15700-V2L, WV-X15700-V2LN, WV-X22700-V2L, WV-X25700-V2LN, WV-X25580-F2LN2</p> |
| [Compact] | Compact Dome cameras | <p>WV-X35402-F2LM, WV-X35302-F2LM, WV-X35402-F2L, WV-X35302-F2L, WV-S35402-F2L, WV-S35402-F2LG, WV-S35402-F2L1, WV-S32402-F2L, WV-S32402-F2LG, WV-S32402-F2L1, WV-S35302-F2L, WV-S35302-F2LG, WV-S35302-F2L1, WV-S32302-F2L, WV-S32302-F2LG, WV-S32302-F2L1, WV-U35401-F2L, WV-U35401-F2LG, WV-U35301-F2L, WV-U35301-F2LG, WV-U31401-F2L, WV-U31401-F2LG, WV-U31301-F2L, WV-U31301-F2LG</p> |
| [CompactX] | Compact Dome cameras (X-series) | <p>WV-X35402-F2LM, WV-X35302-F2LM, WV-X35402-F2L, WV-X35302-F2L</p> |
| [CompactS] | Compact Dome cameras (S-series) | <p>WV-S35402-F2L, WV-S35402-F2LG, WV-S35402-F2L1, WV-S32402-F2L,</p> |

1 Introduction

1.2 Compatible models and symbols in this manual

| | | |
|-----------------|------------------------------------------------------------|---------------------------------------------------------------------------------------------------------------------------|
| | | WV-S32402-F2LG、WV-S32402-F2L1、WV-S35302-F2L、WV-S35302-F2LG、 WV-S35302-F2L1、WV-S32302-F2L、WV-S32302-F2LG、WV-S32302-F2L1 |
| [CompactU] | Compact Dome cameras (U-series) | WV-U35401-F2L、WV-U35401-F2LG、WV-U35301-F2L、WV-U35301-F2LG、 WV-U31401-F2L、WV-U31401-F2LG、WV-U31301-F2L、WV-U31301-F2LG |
| [CompactX·S-4M] | Compact Dome cameras (X/S series, Image capture size: 4MP) | WV-X35402-F2LM、WV-X35402-F2L、WV-S35402-F2L、WV-S35402-F2LG、 WV-S35402-F2L1、WV-S32402-F2L、WV-S32402-F2LG、WV-S32402-F2L1 |
| [CompactX·S-2M] | Compact Dome cameras (X/S series, Image capture size: 2MP) | WV-X35302-F2LM、WV-X35302-F2L、WV-S35302-F2L、WV-S35302-F2LG、 WV-S35302-F2L1、WV-S32302-F2L、WV-S32302-F2LG、WV-S32302-F2L1 |
| [CompactU-4M] | Compact Dome cameras (U series, Image capture size: 4MP) | WV-U35401-F2L、WV-U35401-F2LG、WV-U35301-F2L、WV-U35301-F2LG |
| [CompactU-2M] | Compact Dome cameras (U series, Image capture size: 2MP) | WV-U31401-F2L、WV-U31401-F2LG、WV-U31301-F2L、WV-U31301-F2LG |

1 Introduction

1.2 Compatible models and symbols in this manual

| | | |
|------------------|-----------------------------------------------|-----------------------------------------------------------------------------------------------------------------------------------------------------------------------------------------------------------------------------------------|
| [New X Fixed] | New X Fixed cameras | WV-X15300-V3L、WV-X15300-V3LN、WV-X22300-V3L、WV-X25300-V3LN、WV-X15500-V3L、WV-X15500-V3LN、WV-X22500-V3L、WV-X25500-V3LN、WV-X15600-V2L、WV-X15600-V2LN、WV-X22600-V2L、WV-X25600-V2LN、WV-X15700-V2L、WV-X15700-V2LN、WV-X22700-V2L、WV-X25700-V2LN |
| [New X Fixed-2M] | New X Fixed cameras (Image capture size: 2MP) | WV-X15300-V3L、WV-X15300-V3LN、WV-X22300-V3L、WV-X25300-V3LN |
| [New X Fixed-5M] | New X Fixed cameras (Image capture size: 5MP) | WV-X15500-V3L、WV-X15500-V3LN、WV-X22500-V3L、WV-X25500-V3LN |
| [New X Fixed-6M] | New X Fixed cameras (Image capture size: 6MP) | WV-X15600-V2L、WV-X15600-V2LN、WV-X22600-V2L、WV-X25600-V2LN |
| [New X Fixed-8M] | New X Fixed cameras (Image capture size: 8MP) | WV-X15700-V2L、WV-X15700-V2LN、WV-X22700-V2L、WV-X25700-V2LN |
| [Corner] | Corner cameras | WV-X25580-F2LN2 |

| Symbol | Term | Model |
|--------|-------------|-----------------------------------------------------------------------------------------------------------------------------------------------------------------------------------|
| [PTZ] | PTZ cameras | WV-X86531-Z2(PTZ part)、WV-X86531-Z2-1(PTZ part)、WV-X86530-Z2(PTZ part)、WV-X86530-Z2-1(PTZ part)、WV-S66700-Z3L、WV-X66700-Z3LS、WV-S66700-Z3、WV-X66700-Z3S、WV-S66700-Z3LN、WV-X66700- |

1 Introduction

1.2 Compatible models and symbols in this manual

| | | |
|-------------|-------------------|-------------------------------------------------------------------------------------------------------------------------------------------------------------------------------------------------------------------------------------------------------------------------------------------------------------------------------------------------------------------------------------------------------------------------------------------------------------------------------------------------------------------------------------------------------------------------------------------------------------------------------------------------------------------------------------------|
| | | <p>Z3LK、WV-S66700-Z3N、WV-X66700-Z3K、 WV-S61702-Z3、WV-X67700-Z3-3、 WV-X67700-Z3L3、WV-X67710-Z3-1、 WV-X67710-Z3L1、WV-X67710-Z3-3、WV-X67710-Z3L3、WV-S66600-Z3L、 WV-X66600-Z3LS、WV-S66600-Z3、 WV-X66600-Z3S、WV-S66600-Z3LN、 WV-X66600-Z3LK、WV-S66600-Z3N、WV-X66600-Z3K、WV-S61602-Z3、 WV-S66300-Z4L、WV-X66300-Z4LS、WV-S66300-Z3L、WV-X66300-Z3LS、 WV-S66300-Z4、WV-X66300-Z4S、 WV-S66300-Z3、WV-X66300-Z3S、 WV-S66300-Z4LN、WV-X66300-Z4LK、WV-S66300-Z3LN、WV-X66300-Z3LK、 WV-S66300-Z4N、WV-X66300-Z4K、WV-S66300-Z3N、WV-X66300-Z3K、 WV-X67300-Z4-3、WV-X67300-Z4L3、WV-X67310-Z4-1、WV-X67310-Z4L1、 WV-X67310-Z4-3、WV-X67310-Z4L3</p> |
| [Rapid PTZ] | Rapid PTZ cameras | <p>WV-S66700-Z3L、WV-X66700-Z3LS、WV-S66700-Z3、WV-</p> |

1 Introduction

1.2 Compatible models and symbols in this manual

| | | |
|--------------------|-------------------------------------------------------------|-----------------------------------------------------------------------------------------------------------------------------------------------------------------------------------------------------------------------------------------------------------------------------------------------------------------------------------------------------------------------------------------------------------------------------------------------------------------------------------------|
| | | <p>X66700-Z3S, WV-S66700-Z3LN、WV-X66700-Z3LK、WV-S66600-Z3L、WV-X66600-Z3LS、 WV-S66600-Z3、WV-X66600-Z3S、 WV-S66600-Z3LN、WV-X66600-Z3LK、 WV-S66300-Z4L、WV-X66300-Z4LS、WV-S66300-Z4LN、WV-X66300-Z4LK、 WV-S66300-Z3L、WV-X66300-Z3LS、WV-S66300-Z3LN、WV-X66300-Z3LK、 WV-S66700-Z3N、WV-X66700-Z3K、WV-S66600-Z3N、WV-X66600-Z3K、 WV-S66300-Z4、WV-X66300-Z4S、 WV-S66300-Z3、WV-X66300-Z3S、 WV-S66300-Z4N、WV-X66300-Z4K、WV-S66300-Z3N、WV-X66300-Z3K</p> |
| [Rapid PTZ-8M(4K)] | Rapid PTZ cameras (X/S series, Image capture size: 8M (4K)) | <p>WV-S66700-Z3L、WV-X66700-Z3LS、WV-S66700-Z3、WV-X66700-Z3S、 WV-S66700-Z3LN、WV-X66700-Z3LK、WV-S66700-Z3N、WV-X66700-Z3K</p> |
| [Rapid PTZ-6M] | Rapid PTZ camera(X/S Series, Image capture size: 6MP) | <p>WV-S66600-Z3L、WV-X66600-Z3LS、WV-S66600-Z3、WV-X66600-Z3S、 WV-S66600-Z3LN、WV-X66600-Z3LK、WV-S66600-Z3N、WV-X66600-Z3K</p> |
| [Rapid PTZ-2M] | Rapid PTZ camera(X/S Series, Image capture size: 2MP) | <p>WV-S66300-Z4L、WV-X66300-Z4LS、WV-S66300-Z3L、WV-</p> |

1 Introduction

1.2 Compatible models and symbols in this manual

| | | |
|---------------------|--------------------------------------------------|-----------------------------------------------------------------------------------------------------------------------------------------------------------------------------------------------------------------------|
| | | X66300-Z3LS, WV-S66300-Z4、WV-X66300-Z4S、 WV-S66300-Z3、WV-X66300-Z3S、 WV-S66300-Z4LN、WV-X66300- Z4LK、WV-S66300-Z3LN、WV- X66300-Z3LK、 WV-S66300-Z4N、WV-X66300- Z4K、WV-S66300-Z3N、WV- X66300-Z3K |
| [Indoor PTZ] | Indoor PTZ cameras | WV-S61702-Z3、WV-S61602-Z3 |
| [Indoor PTZ-8M(4K)] | Indoor PTZ cameras (Image capture size: 8M (4K)) | WV-S61702-Z3 |
| [Indoor PTZ-6M] | Indoor PTZ cameras (Image capture size: 6MP) | WV-S61602-Z3 |
| [Aero PTZ] | Aero PTZ cameras | WV-X67700-Z3-3、WV-X67700- Z3L3、WV-X67710-Z3-1、WV- X67710-Z3L1、 WV-X67710-Z3-3、WV-X67710- Z3L3、WV-X67300-Z4-3、WV- X67300-Z4L3、 WV-X67310-Z4-1、WV-X67310- Z4L1、WV-X67310-Z4-3、WV- X67310-Z4L3 |
| [Aero PTZ-8M (4K)] | Aero PTZ cameras (Image capture size: 8M (4K)) | WV-X67700-Z3-3、WV-X67700- Z3L3、WV-X67710-Z3-1、WV- X67710-Z3L1、 WV-X67710-Z3-3、WV-X67710- Z3L3 |
| [Aero PTZ-2M] | Aero PTZ cameras (Image capture size: 2MP) | WV-X67300-Z4-3、WV-X67300- Z4L3、WV-X67310-Z4-1、WV- X67310-Z4L1、 WV-X67310-Z4-3、WV-X67310- Z4L3 |
| [MULTI] | Multi-directional cameras | WV-X86531-Z2(Multi part)、 |

1 Introduction

1.2 Compatible models and symbols in this manual

| | | |
|-------------|--------------------------------------------|-------------------------------------------------------------------------------------------------------------------------------------------------------------------------------------------------------------------------------------|
| | | WV-X86531-Z2-1(Multi part), WV-X86530-Z2(Multi part), WV-X86530-Z2-1(Multi part), WV-S85702-F3L, WV-S85702-F3L1, WV-S85402-V2L, WV-S85402-V2L1, WV-U85402-V2L, WV-U85402-V2L1 |
| [MULTI4] | Multi-directional cameras (4 eyes) | WV-X86531-Z2(Multi part), X86531-Z2-1(Multi part) |
| [MULTI3] | Multi-directional cameras (3 eyes) | WV-X86530-Z2(Multi part), WV-X86530-Z2-1(Multi part) |
| [MULTI2] | Multi-directional cameras (2 eyes) | WV-S85702-F3L, WV-S85702-F3L1, WV-S85402-V2L, WV-S85402-V2L1, WV-U85402-V2L, WV-U85402-V2L1 |
| [MULTI2S] | Multi-directional cameras (2-eye S-series) | WV-S85702-F3L, WV-S85702-F3L1, WV-S85402-V2L, WV-S85402-V2L1 |
| [MULTI2U] | Multi-directional cameras (2-eye U-series) | WV-U85402-V2L, WV-U85402-V2L1 |
| [MULTI_PTZ] | Multi-directional + PTZ | WV-X86531-Z2(PTZ part), WV-X86531-Z2-1(PTZ part), WV-X86530-Z2(PTZ part), WV-X86530-Z2-1(PTZ part), WV-X86531-Z2(Multi part), WV-X86531-Z2-1(Multi part), WV-X86530-Z2(Multi part), WV-X86530-Z2-1(Multi part) |
| [Fixed] | Fixed cameras | WV-X35402-F2LM, WV-X35302-F2LM, WV-X35402-F2L, WV-X35302-F2L, WV-S35402-F2L, WV-S35402- |

1 Introduction

1.2 Compatible models and symbols in this manual

| | | |
|-----------|----------------------|--------------------------------------------------------------------------------------------------------------------------------------------------------------------------------------------------------------------------------------------------------------------------------------------------------------------------------------------------------------------------------------------------------------------------------------------------------------------------------------------------------------------------------------------------------------------------------------------------|
| | | <p>F2LG、WV-S35402-F2L1、WV-S32402-F2L、 WV-S32402-F2LG、WV-S32402-F2L1、WV-S35302-F2L、WV-S35302-F2LG、 WV-S35302-F2L1、WV-S32302-F2L、WV-S32302-F2LG、WV-S32302-F2L1、 WV-U35401-F2L、WV-U35401-F2LG、WV-U35301-F2L、WV-U35301-F2LG、 WV-U31401-F2L、WV-U31401-F2LG、WV-U31301-F2L、WV-U31301-F2LG、 WV-X15300-V3L、WV-X15300-V3LN、WV-X22300-V3L、WV-X25300-V3LN、 WV-X15500-V3L、WV-X15500-V3LN、WV-X22500-V3L、WV-X25500-V3LN、 WV-X15600-V2L、WV-X15600-V2LN、WV-X22600-V2L、WV-X25600-V2LN、 WV-X15700-V2L、WV-X15700-V2LN、WV-X22700-V2L、WV-X25700-V2LN、 WV-X25580-F2LN2</p> |
| [Compact] | Compact Dome cameras | <p>WV-X35402-F2LM、WV-X35302-F2LM、WV-X35402-F2L、WV-X35302-F2L、 WV-S35402-F2L、WV-S35402-F2LG、WV-S35402-F2L1、WV-</p> |

1 Introduction

1.2 Compatible models and symbols in this manual

| | | |
|------------|---------------------------------|-------------------------------------------------------------------------------------------------------------------------------------------------------------------------------------------------------------------------------------------------------------------------------------|
| | | <p>S32402-F2L、 WV-S32402-F2LG、WV-S32402-F2L1、WV-S35302-F2L、WV-S35302-F2LG、 WV-S35302-F2L1、WV-S32302-F2L、WV-S32302-F2LG、WV-S32302-F2L1、 WV-U35401-F2L、WV-U35401-F2LG、WV-U35301-F2L、WV-U35301-F2LG、 WV-U31401-F2L、WV-U31401-F2LG、WV-U31301-F2L、WV-U31301-F2LG</p> |
| [CompactX] | Compact Dome cameras (X-series) | <p>WV-X35402-F2LM、WV-X35302-F2LM、WV-X35402-F2L、WV-X35302-F2L</p> |
| [CompactS] | Compact Dome cameras (S-series) | <p>WV-S35402-F2L、WV-S35402-F2LG、WV-S35402-F2L1、WV-S32402-F2L、 WV-S32402-F2LG、WV-S32402-F2L1、WV-S35302-F2L、WV-S35302-F2LG、 WV-S35302-F2L1、WV-S32302-F2L、WV-S32302-F2LG、WV-S32302-F2L1</p> |
| [CompactU] | Compact Dome cameras (U-series) | <p>WV-U35401-F2L、WV-U35401-F2LG、WV-U35301-F2L、WV-U35301-F2LG、 WV-U31401-F2L、WV-U31401-F2LG、WV-U31301-F2L、WV-U31301-F2LG</p> |

1 Introduction

1.2 Compatible models and symbols in this manual

| | | |
|------------------|------------------------------------------------------------|-----------------------------------------------------------------------------------------------------------------------------------------------------------------------------------------------------------------------------------------|
| [CompactX•S-4M] | Compact Dome cameras (X/S series, Image capture size: 4MP) | WV-X35402-F2LM、WV-X35402-F2L、WV-S35402-F2L、WV-S35402-F2LG、WV-S35402-F2L1、WV-S32402-F2L、WV-S32402-F2LG、WV-S32402-F2L1 |
| [CompactX•S-2M] | Compact Dome cameras (X/S series, Image capture size: 2MP) | WV-X35302-F2LM、WV-X35302-F2L、WV-S35302-F2L、WV-S35302-F2LG、WV-S35302-F2L1、WV-S32302-F2L、WV-S32302-F2LG、WV-S32302-F2L1 |
| [CompactU-4M] | Compact Dome cameras (U series, Image capture size: 4MP) | WV-U35401-F2L、WV-U35401-F2LG、WV-U35301-F2L、WV-U35301-F2LG |
| [CompactU-2M] | Compact Dome cameras (U series, Image capture size: 2MP) | WV-U31401-F2L、WV-U31401-F2LG、WV-U31301-F2L、WV-U31301-F2LG |
| [New X Fixed] | New X Fixed cameras | WV-X15300-V3L、WV-X15300-V3LN、WV-X22300-V3L、WV-X25300-V3LN、WV-X15500-V3L、WV-X15500-V3LN、WV-X22500-V3L、WV-X25500-V3LN、WV-X15600-V2L、WV-X15600-V2LN、WV-X22600-V2L、WV-X25600-V2LN、WV-X15700-V2L、WV-X15700-V2LN、WV-X22700-V2L、WV-X25700-V2LN |
| [New X Fixed-2M] | New X Fixed cameras (Image capture size: 2MP) | WV-X15300-V3L、WV-X15300-V3LN、WV-X22300-V3L、WV-X25300-V3LN |
| [New X Fixed-5M] | New X Fixed cameras (Image capture size: 5MP) | WV-X15500-V3L、WV-X15500-V3LN、WV-X22500-V3L、WV-X25500-V3LN |

| | | |
|------------------|-----------------------------------------------|-----------------------------------------------------------|
| [New X Fixed-6M] | New X Fixed cameras (Image capture size: 6MP) | WV-X15600-V2L、WV-X15600-V2LN、WV-X22600-V2L、WV-X25600-V2LN |
| [New X Fixed-8M] | New X Fixed cameras (Image capture size: 8MP) | WV-X15700-V2L、WV-X15700-V2LN、WV-X22700-V2L、WV-X25700-V2LN |
| [Corner] | Corner cameras | WV-X25580-F2LN2 |

1.3 Abbreviation

This document uses the following abbreviations.

The Japanese version of Microsoft Windows 10 is called Windows 10.

The Japanese version of Microsoft Windows 11 is called Windows 11.

The microSDXC/microSDHC/microSD memory card is called an SD card or SD memory card.

Universal Plug and Play is designated UPnP™ or UPnP.

1.4 Disclaimer

- The purpose of this product is to obtain images for monitoring specific areas. This product alone is not intended to prevent crimes.
- In no event shall we be liable for the following:
 - ① Any incidental, special or consequential damages or damages arising directly or indirectly in connection with the Goods
 - ② Inconvenience, damage or damage caused by improper or inadvertent use by the customer or damage to the product
 - ③ Any failure or fault which has occurred, whether or not caused by the customer's disassembly, repair or modification of the Goods
 - ④ Any inconvenience, damage, or damage incurred due to the inability to display images for any reason or cause, including a failure or malfunction of the Product
 - ⑤ Failure or inconvenience, damage, or damage caused by a system combined with a third party device
 - ⑥ Claims or claims for damages caused by infringement of privacy by an individual or organization that has become the subject of a picture as a result of the use of surveillance

images and records made public for some reason (including use with the User Authentication Off).

- ⑦ The registered data is lost due to some reason (including when product is initialized by forgetting the credentials such as repair, username, and password).

1.5 For trademarks and registered trademarks

- Microsoft, Windows, Windows Media, Microsoft Edge, and ActiveX are registered trademarks or trademarks of Microsoft Corporation in the United States and/or other countries.
- Intel, Intel Core is a trademark of Intel Corporation or its subsidiaries in the United States and/or other countries.
- Adobe, Acrobat Reader and Adobe Reader are trademarks of Adobe.
- SDXC Logos are trademarks of SD-3C, LLC.
- iPad and iPhone are trademarks of Apple Inc. registered in the United States and other countries.
- Android and Google Chrome are trademarks of Google LLC.
- Firefox is a trademark of the Mozilla Foundation in the United States and other countries.
- QR Code is a registered trademark of DENSO WAVE CORPORATION.
- Other company names and product names described in this manual are trademarks or registered trademarks of each company.

1.6 NETWORK RELATIONSHIP

Since this equipment is connected to the network, it may be damaged as follows.

- ① Leakage or leakage of information via the machine
- ② Malicious operation of the Aircraft by a malicious third party
- ③ Interference or stoppage of the Aircraft by a malicious third party

In order to prevent such damage, take adequate network security measures including the following measures under the responsibility of the customer.

- Use the machine on a secure network using firewalls, etc.
- Confirm that computer viruses and malicious programs are regularly checked and exterminated when the computer is connected to the system.

- Use user authentication, set user names and passwords, and restrict users who can log in to protect against unauthorized attacks.
- In order to prevent image data, authentication information (user name, password), alarm mail information, DDNS server information, etc. from being leaked on the network, measures are taken to restrict access by user authentication.
- Be sure to close all browsers after administrators have accessed the machine.
- Store the authentication information (user name and password) appropriately so that it is not visible to third parties.
- Do not install the equipment or cables in a place where they are easily destroyed.

1.7 Instructions for use

When using the machine via the Internet

In order to prevent unintended access by third parties,

- Keep the user authentication setting [On].

For long-term stable performance

Do not use the product in a place with high temperature and high humidity for a long time.

Degradation of parts shortens the life of the product.

Improve the heat dissipation in the installation area and prevent direct exposure to heat such as heating.

If the power supply is turned off and on repeatedly, failure of the equipment may result.

Handle with care

Do not drop or apply strong shock or vibration. Failure to heed this warning may result in failure.

Do not touch the dome cover directly.

If dirty, image quality may deteriorate.

When an error is detected, restart automatically.

The computer automatically restarts when an error is detected for some reason. When restarting, the operation cannot be performed for approximately 2 minutes as it was when the power was turned on.

Operation status detection function

If abnormal operation is continued for 30 seconds or longer due to external noise or the like during operation, the computer will restart automatically and return to normal operation. The restart operation is the same as when the power is turned on. However, if the restart occurs frequently, external noise may be generated frequently in the installation environment of this equipment.

Consult your dealer as soon as possible, as this may cause a malfunction.

Periodic distortion of the screen

If the camera is installed in a place where it vibrates in small increments (for example, close to a vibrating device), the screen may periodically become distorted to extend and contract lengthwise. This is a characteristic phenomenon that occurs when the CMOS sensor is used for the image pickup device. It is caused by periodic movement of the screen and the timing of reading out the image from the image sensor, and it is not an error in the camera. Reassess the installation condition and ensure the stability of the camera body to alleviate the problem.

We shall not be liable for any loss of, or direct or indirect damage caused by, any compensation, recording, or editing of the contents that could not be correctly recorded or edited due to a defect in the machine or the microSD memory card. The same shall apply to the case of repair of the Aircraft.

CMOS sensor

- If a portion of the screen is bright, such as spot light, the color filter inside the CMOS sensor may deteriorate, resulting in discoloration. When the direction of fixed monitoring is changed, spot light on the previous screen will change color and remain.
- When you shoot a fast-moving object, you may see the object bending diagonally across the screen.

Temperature sensorWith respect to

The built-in temperature sensor is used to measure the temperature inside the camera.

For maintenance

Turn off the power before starting operation. Doing so may result in injury.

Do not apply or use organic solvents such as benzene and thinner. The case may become discolored. Follow the precautionary statement when using chemical foil.

- Do not loosen or remove the screws not specified in the operation manual.
- [PTZ Cameras]

Be sure to refresh the position or restart the this product since the camera may have been turned after maintenance. For details, please refer to the following.

→[16.4 \[Default reset\] to initialize and restart the computer](#)

Cleaning the dome cover

If the dome cover is dirty, clean it with a lens cleaning paper (for cleaning cameras and eyeglasses).

Picture shaking correction function

Depending on the installation location, the shaking correction function may not be sufficiently effective.

Consumables

In some models, consumables are included in parts.

Refer to the web guide for consumables.

Motor operation noise

Depending on the operation speed of the pan or tilt, the operation sound may become louder. If you are concerned about the operation sound from the auto pan, you can improve it by lowering the set speed of the auto pan.

About the AVC Patent Portfolio License

THIS PRODUCT IS LICENSED UNDER THE AVC PATENT PORTFOLIO LICENSE FOR THE PERSONAL USE OF A CONSUMER OR OTHER USES IN WHICH IT DOES NOT RECEIVE REMUNERATION TO (i) ENCODE VIDEO IN COMPLIANCE WITH THE AVC STANDARD ("AVC VIDEO") AND/OR (ii) DECODE AVC VIDEO THAT WAS ENCODED BY A CONSUMER ENGAGED IN A PERSONAL ACTIVITY AND/OR WAS OBTAINED FROM A VIDEO PROVIDER LICENSED TO PROVIDE AVC VIDEO. NO LICENSE IS GRANTED OR SHALL BE IMPLIED FOR ANY OTHER USE. ADDITIONAL INFORMATION MAY BE OBTAINED FROM MPEG LA, L.L.C. SEE [HTTP://WWW.MPEGLA.COM](http://www.mpegla.com)

Position Refresh

[PTZ Cameras]

If the watch is used for a long time, the preset position may be misaligned. It is recommended to set position refresh using the schedule function and periodically correct camera misalignment.

Refer to the following instructions for setting.

→15 [\[Schedule\] for scheduling](#)

In the event the Aircraft is transferred or disposed of

The contents of the information recorded on the computer and the contents of the information recorded on the storage media used with the computer may correspond to "personal information."

When handing over the unit to a third party for disposal, transfer, repair, etc., pay careful attention to the handling. When discarding the storage media, it is recommended to physically destroy the data after deleting it with a PC, etc.

In addition, delete the device or user information registered in the external service or application that uses this machine.

Connection to the Internet

The Aircraft cannot be connected directly to communication lines (including public wireless LANs) of telecommunications carriers (mobile carriers, fixed carriers, Internet providers, etc.). When connecting the computer to the Internet, be sure to connect via a router.

Protection of personal information

Personal information shot using the system is subject to the Personal Information Protection Law.

Handle video information properly in accordance with the law.

※Refer to the "Guidelines for the Act on the Protection of Personal Information (General Rules)" of the Personal Information Protection Committee for examples corresponding to personal information.

About HEVC(High Efficiency Video Coding) patents

Covered by one or more claims of the HEVC patents listed at patentlist.accessadvance.com.

About Routers

When connecting this product to the Internet and using a router, use a broadband router with a port forwarding function (NAT, IP Mascalade). For an overview of the port forwarding feature, see the following.

→[14.1 Networking \[Network\]](#)

Time Setting

The this product must be set to the time prior to starting operation. For the time setting, refer to the following.

→[2.1 Initial Setting](#)

→[2.2 Initial setting \(Multi-directional/PTZ integrated camera\)](#)

2 Operation

2.1 Initial Setting

[Administrator registration](#)

The administrator registration screen is displayed when the camera is first accessed (or when the camera is initialized).

Enter an administrator's user name and password to ensure that there are no mistakes. Use the following login.

Administrator registration

The initial setup of the administrator name and password is required on this screen.

Manage them safely and be sure not to forget them.

User name (1 to 32 characters)

Password (8 to 32 characters)

Retype password

Set

Note:

- (1) Distinguish between upper- and lower cases.
- (2) Entry of the following is not allowed as a user name: 2-byte characters, and 1-byte symbols " & ; ; \
- (3) Entry of the following is not allowed as a password: 2-byte characters, and 1-byte symbols " &
- (4) For the password, use three or more types of characters from upper- and lowercase alphabetic characters, numbers, and symbols.
- (5) Keep the user name and password at hand so as not to lose.
- (6) It is recommended to change the password periodically.
- (7) Set the password which does not include the user name.

• [User name (1 to 32 characters)]

Enter an administrator username.

- **Number of characters that can be entered:** 1 to 32 characters
- **Characters that cannot be entered:** Double-byte and single-byte symbols & ; ¥

• [Password (8 to 32 characters)]/[Retype password]

Enter the administrator's password.

- **Number of characters that can be entered:** 8 to 32 characters
- **Characters that cannot be entered:** Double-byte and single-byte symbols &



[Note:]

- Enter case-sensitive data.
- Use at least three of the following passwords: uppercase alphabetic characters, lowercase alphabetic characters, numbers, and symbols.
- Configure the password so that it does not contain the user name.



[Important]

- If the set user name or password is lost, the camera must be initialized. When the camera is formatted, all settings will be cleared. Keep the user name and password out of the eyes of third parties. Refer to the Web Guide for the formatting method.
- Do not use other cameras, devices, or other passwords.

After registering the user name and password of the administrator, the Language/Datetime setting screen is displayed.

[Language/Datetime Settings](#)

Language/time and date setting

| | | | |
|---------------|-------------------|---------------------|--------------------------|
| Menu language | Date/time display | Time display format | Date/time display format |
| Auto ▾ | On ▾ | 24h ▾ | Mmm-DD-YYYY ▾ |
| Date | Time | Date/time position | |
| Aug-28-2024 📅 | 11:23:05 🕒 | Upper left ▾ | |

Set PC time to the camera

Time zone

(GMT+09:00) Osaka, Sapporo, Tokyo ▾

Summer time(daylight saving)

Out ▾

Screen setting

| | |
|---------|------------------------|
| Color | Operation panel layout |
| Light ▾ | Bottom ▾ |

Set

Language/Datetime Settings

- **[Menu language]**

Select the first language that appears when you access the camera from the list below.

[Auto]/[English]/[Japanese]/[Italian]/[French]/[German]/[Spanish]/[Chinese]/[Russian]/
[Portuguese]

[Auto] automatically selects the languages used by the browser. If your computer is not compatible with the language, the English language is selected.

- **[Time display format]**

Select the time display method from 24h/12h.

- **[Date/time display format]**

Select the date display format. If [Date/time] is set to [13:10:00 on April 1, 2021], the display formats are as follows.

- DD/MM/YYYY: 01/04/2021 13:10:00

- MM/DD/YYYY: 04/01/2021 13:10:00
- DD/Mmm/YYYY: 01/Apr/2021 13:10:00
- YYYY/MM/DD: 2021/04/01 13:10:00
- Mmm/DD/YYYY: Apr/01/2021 13:10:00
- **[Date]**
 - ☐ Click the button to set the camera date.
 - ☐ Click to get the date of the PC and display it.
- **[Time]**
 - 🕒 Click the button to enter the camera time.
 - 🕒 Click to acquire the time of the PC and display it.



[Important]

- If you need to set the time more accurately in system operation, use the NTP server.

→ [14.2.3 Set up an NTP server](#)

- **[Date/time position]**

Select the position where the date and time are displayed on the image.

 - [Upper left]: Displayed in the upper left corner of the window.
 - [Lower left]: Displays in the lower left corner of the window.
 - [Upper center]: Displayed in the center of the window.
 - [Lower center]: Displays at the bottom center of the window.
 - [Upper right]: Displayed in the upper right corner of the window.
 - [Lower right]: Displays in the lower right corner of the window.



[Note:]

- If you want to set whether or not to display the date and time on the images, use the [Basic] pages in the Advanced menu.

→ [8 \[Basic\] for basic setup of the machine](#)

- **[Time zone]**

Select the time zone for the camera area.
- **[Summer time(daylight saving)]**

Use [In], [Out] and [Auto] to specify whether to use Daylight Saving Time. Set in the region where Daylight Saving Time is used.

 - [In] sets the time to Daylight Saving Time. [*] is displayed in the time display.
 - [Out] cancels Daylight Saving Time.
 - [Auto] switches to Daylight Saving Time according to the start date and time and end date

settings (month, week, day of the week, and time).

- **[Start time & date] [End time & date]**

When [Auto] is selected in [Summer time(daylight saving)] Setting, the start date and time of Daylight Saving Time and the end date and time of Daylight Saving Time are set in Month, Week, Day of Week, and Time.

Screen settings

- **[Character color]**

Select the background color of the operation panels and advanced menus from the [Light] [Dark].

- **[Operation panel layout]**

Select the position of the control panel from [Right], [Left], and [Lower].

2.2 Initial setting (Multi-directional/PTZ integrated camera)

Administrator registration

The administrator registration screen is displayed when the camera is first accessed (or when the camera is initialized).

Enter an administrator's user name and password to ensure that there are no mistakes. Use the following login.

Administrator registration

The initial setup of the administrator name and password is required on this screen.
Manage them safely and be sure not to forget them.

Perform the initial setting of both the PTZ camera and the multi-directional camera.

Set to both cameras

| | |
|------------------------------------------------------------------------------|--------------------------------------------------------------------------------------------|
| <p>PTZ Camera</p> <p>User name (1 to 32 characters)</p> <input type="text"/> | <p>Multi-directional camera</p> <p>User name (1 to 32 characters)</p> <input type="text"/> |
| <p>Password (8 to 32 characters)</p> <input type="password"/> | <p>Password (8 to 32 characters)</p> <input type="password"/> |
| <p>Retype password</p> <input type="password"/> | <p>Retype password</p> <input type="password"/> |

Note:

- (1) If you want to operate the PTZ camera and multi-directional camera in cooperation with screen clicking or alarm notification, Set the same user name and password on both cameras.
- (2) Distinguish between upper- and lower cases.
- (3) Entry of the following is not allowed as a user name: 2-byte characters, and 1-byte symbols " & ; \
- (4) Entry of the following is not allowed as a password: 2-byte characters, and 1-byte symbols " &
- (5) For the password, use three or more types of characters from upper- and lowercase alphabetic characters, numbers, and symbols.
- (6) Keep the user name and password at hand so as not to lose.
- (7) It is recommended to change the password periodically.
- (8) Set the password which does not include the user name.

- [Set to both cameras]

When the setting is performed with the checkbox checked, the [User name] and [Password] entered into the PTZ camera are also set for the Multi-directional camera.

If you want to set up different administrator information for the PTZ camera and the Multi-directional camera, uncheck the checkbox and enter [User name] and [Password].

- [User name (1 to 32 characters)]

Enter an administrator username.

- **Number of characters that can be entered:** 1 to 32 characters
- **Characters that cannot be entered:** Double-byte and single-byte symbols " & ; ¥

- **[Password (8 to 32 characters)]/[Retype password]**

Enter the administrator's password.

- **Number of characters that can be entered:** 8 to 32 characters
- **Characters that cannot be entered:** Double-byte and single-byte symbols " &



[Note:]

- Enter case-sensitive data.
- Use at least three of the following passwords: uppercase alphabetic characters, lowercase alphabetic characters, numbers, and symbols.
- Configure the password so that it does not contain the user name.
- If you want the PTZ camera and the Multi-directional camera to work together by screen clicking or alarm notification, set the same user name and password for both cameras.



[Important]

- If the set user name or password is lost, the camera must be initialized. When the camera is formatted, all settings will be cleared. Keep the user name and password out of the eyes of third parties. Refer to the Operation Manual Web Guide for the formatting method.
- Do not use other cameras, devices, or other passwords.

After registering the user name and password of the administrator, the Language/Datetime setting screen is displayed.

[Language/Datetime Settings](#)

Language/time and date setting

| | | | |
|----------------------|--------------------------|----------------------------|---------------------------------|
| Menu language | Date/time display | Time display format | Date/time display format |
| Auto ▾ | On ▾ | 24h ▾ | Mmm-DD-YYYY ▾ |
| Date | Time | Date/time position | |
| Aug-28-2024 📅 | 11:59:01 🕒 | Upper left ▾ | |

Set PC time to the camera

Time zone

(GMT+09:00) Osaka, Sapporo, Tokyo ▾

Summer time(daylight saving)

Out ▾

Screen setting

| | |
|--------------|-------------------------------|
| Color | Operation panel layout |
| Light ▾ | Bottom ▾ |

Language/Datetime Settings

- **[Menu language]**

Select the first language that appears when you access the camera from the list below.

[Auto]/[English]/[Japanese]/[Italian]/[French]/[German]/[Spanish]/[Chinese]/[Russian]/
[Portuguese]

[Auto] automatically selects the languages used by the browser. If your computer is not compatible with the language, the English language is selected.

- **[Time display format]**

Select the time display method from 24h/12h.

- **[Date/time display format]**

Select the date display format. If [Date/time] is set to [13:10:00 on April 1, 2021], the display formats are as follows.

- DD/MM/YYYY: 01/04/2021 13:10:00

- MM/DD/YYYY: 04/01/2021 13:10:00
- DD/Mmm/YYYY: 01/Apr/2021 13:10:00
- YYYY/MM/DD: 2021/04/01 13:10:00
- Mmm/DD/YYYY: Apr/01/2021 13:10:00
- **[Date]**
 - ☐ Click the button to set the camera date.
 - ☐ Click to get the date of the PC and display it.
- **[Time]**
 - Click the button to enter the camera time.
 - Click to acquire the time of the PC and display it.



[Important]

- If you need to set the time more accurately in system operation, use the NTP server.

→ [14.2.3 Set up an NTP server](#)

- **[Date/time position]**

Select the position where the date and time are displayed on the image.

 - [Upper left]: Displayed in the upper left corner of the window.
 - [Lower left]: Displays in the lower left corner of the window.
 - [Upper center]: Displayed in the center of the window.
 - [Lower center]: Displays at the bottom center of the window.
 - [Upper right]: Displayed in the upper right corner of the window.
 - [Lower right]: Displays in the lower right corner of the window.



[Note:]

- If you want to set whether or not to display the date and time on the images, use the [Basic] pages in the Advanced menu.

→ [8 \[Basic\] for basic setup of the machine](#)

- **[Time zone]**

Select the time zone for the camera area.
- **[Summer time(daylight saving)]**

Use [In], [Out] and [Auto] to specify whether to use Daylight Saving Time. Set in the region where Daylight Saving Time is used.

 - [In] sets the time to Daylight Saving Time. [*] is displayed in the time display.
 - [Out] cancels Daylight Saving Time.
 - [Auto] switches to Daylight Saving Time according to the start date and time and end date

settings (month, week, day of the week, and time).

- **[Start time & date] [End time & date]**

When [Auto] is selected in [Summer time(daylight saving)] Setting, the start date and time of Daylight Saving Time and the end date and time of Daylight Saving Time are set in Month, Week, Day of Week, and Time.

Screen settings

- **[Character color]**

Select the background color of the operation panels and advanced menus from the [Light] [Dark].

- **[Operation panel layout]**

Select the position of the control panel from [Right], [Left], and [Lower].

Set position

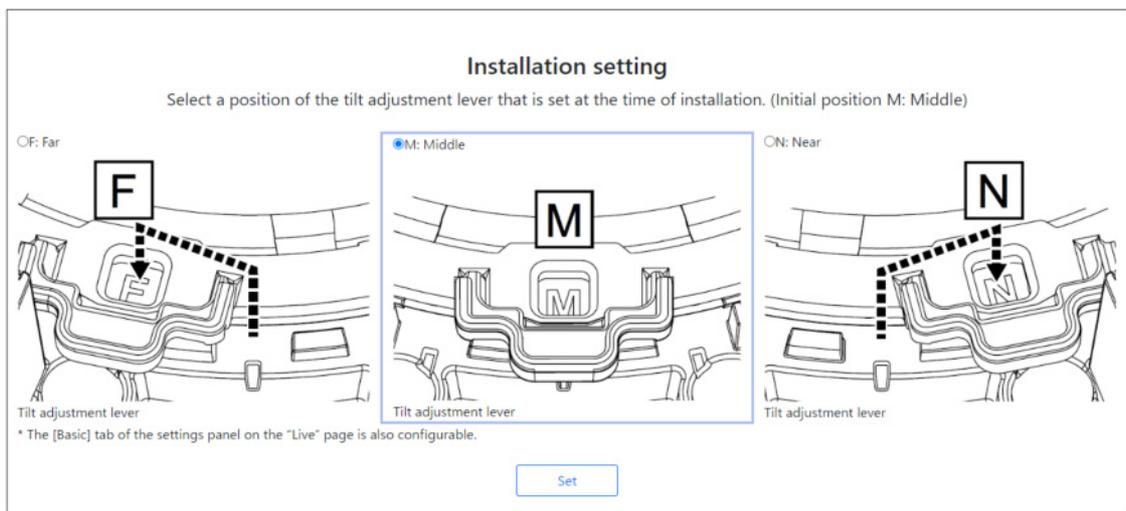

Select the [Tilt adjustment lever position] set when the cameras are installed.



[Note:]

- [Tilt adjustment lever position] can also be set from the [Basic] tabs of the Live Picture Settings pane. Please refer to the following for details.

→3.2 [\[Basic\] to perform basic settings](#)

2.3 Viewing images from a PC

This section explains how to view camera images from a PC.

2.3.1 View camera images

- 1 Start the PC web browser.
- 2 Enter the IP addresses set in the IP Easy Configuration software in the [Address] boxes of the web browser.

Example IPv4 address input:URL registered with the http://IPv4 address

http://192.168.0.10/

Example IPv6 address input:Http://[URL registered with IPv6 address]

Http://[2001:db8::10]/

<Example of IPv4 access>



[Important]

- If the HTTP port number is changed from [80], enter [http://Camera IP address:Port number] in the [Address] box.
e.g., if the port number is set to 8080: http://192.168.0.11:8080
- If your computer is in a local network, configure the proxy server ([Set]-[Network and Internet]-[Proxy]) to avoid using the proxy server for the local address.
- When IPv6 is accessed, the stream image cannot be displayed on the live screen. If you want to display the stream image on the live screen, please access it via IPv4.



[Note:]

- Due to browser limitations, there is an upper limit on the number of browsers that can display video simultaneously. If you try to display images in multiple browsers, the images may not be displayed.
- [HTTPS] on the [Advanced] tab of the network page—for the [HTTPS] configuration in [Connection], the animated support video pages of please refer to our technical information website<Control No. P0002><Control No. P0003>.
→14 [Networking configuration \[Network\]](#)

- 3 Press the [Enter] key to display the user name and password entry screen.

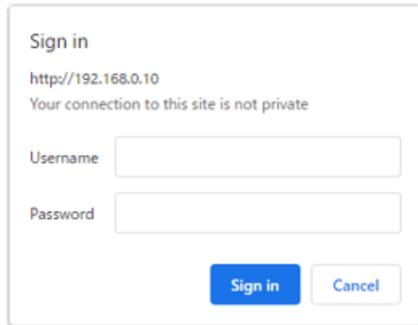

[Note:]

- If [User auth.] is set to [Off], the Username and Password entry window will not be displayed prior to the live page.

- 4 Enter the username and password and click [OK] to display the Live image pages. For more information on Live image pages, please see the following.

→[2.3.2 About live image pages](#)



[Important]

- If you try to display multiple H.265 (or H.264) images on a single PC, depending on the performance of the PC, the image may not be displayed.



[Note:]

- Users with simultaneous access to this product are up to the sum of users receiving H.265 (or H.264) images and users receiving JPEG images. However, depending on the [Bandwidth control(bit rate)] [Bit Rate* per Client] setting, the number of users that can be accessed may be limited to [Maximum number of users] or less. If the number of accessible users exceeds [Maximum number of users], an access excess message is displayed. When [Stream] [Transmission type] is set to [Multicast], the second and subsequent users receiving H.265 (or H.264) images are not counted as accesses.
- [Maximum number of users] depends on the model.
Up to 14 persons: PTZ camera, Multi-directional camera (2-eye U-series), Fixed cameras
Up to 24 persons: Multi-directional camera (4 eyes), Multi-directional camera (3 eyes), Multi-directional camera (2 eyes/S-series)
- When [Stream transmission] is set to [On], the H.265 (or H.264) images are displayed according to the [Stream encoding format] settings. When set to [Off],

JPEG images are displayed. JPEG images can be displayed even if [Stream transmission] is set to [On]. However, in this case, the image update rate of the JPEG image is limited as shown in the table below.

→9.3 [Image] for setting up streams

- Image updating speed of JPEG images may be slow depending on network environments, PC performance, object, and number of accesses.

PTZ camera

Please refer to the following for the relationship between your model and symbols and terminology.

→1.2 Compatible models and symbols in this manual

Rapid PTZ cameras (X/S series, Image capture size: 8M (4K)), Indoor PTZ cameras (Image capture size: 8M (4K))

| Image capture mode | Image capture size | Stream delivery | | | | |
|-----------------------|--------------------|-----------------|----------------------------|--------------|---------|----------------------------|
| | | On | | Off | | |
| | | JPEG(1) | JPEG(2) | JPEG(1) | JPEG(2) | |
| 16:9 mode(30fps mode) | 3840x2160 | Up to 1 fps | | Up to 30 fps | | |
| | 2560x1440 | Up to 2 fps | | | | |
| | 1920x1080 | Up to 5 fps | | | | |
| | 1280x720 | Up to 5 fps | Up to 15 fps* ¹ | | | Up to 30 fps* ¹ |
| | 640x360 | Up to 5 fps | | | | |
| | 320x180 | Up to 5 fps | | | | |
| 16:9 mode(25fps mode) | 3840x2160 | Up to 1 fps | | Up to 25 fps | | |
| | 2560x1440 | Up to 2.1 fps | | | | |
| | 1920x1080 | Up to 4.2 fps | | | | |
| | 1280x720 | Up to 4.2 fps | Up to 12.5 | | | Up to 25 fps* ¹ |
| | 640x360 | Up to 4.2 fps | fps* ¹ | | | |
| | 320x180 | Up to 4.2 fps | | | | |

*1 JPEG (2) is set to [1280x720] if [640x360] is not selected for the resolution set in Streams (1), Streams (2), Streams (3), Streams (4), and JPEG (1) and four resolutions are set.

Rapid PTZ cameras (X/S series, Image capture size: 6MP)

| Image capture mode | Image capture size | Stream delivery | | | |
|--------------------|--------------------|-----------------|--------------|--------------|--------------|
| | | On | | Off | |
| | | JPEG(1) | JPEG(2) | JPEG(1) | JPEG(2) |
| 30 fps mode | 3328x1872 | Up to 1 fps | Up to 15 fps | Up to 30 fps | Up to 30 fps |
| | 2560x1440 | Up to 2 fps | | (*) | (*) |
| | 1920x1080 | Up to 5 fps | | | |

2 Operation

2.3 Viewing images from a PC

Rapid PTZ cameras (X/S series, Image capture size: 6MP) (continued)

| | | | | | |
|-------------|-----------|---------------|----------------|-------------------------------------------------------|-------------------------------------------------------|
| | 1280x720 | Up to 5 fps | | | |
| | 640x360 | Up to 5 fps | | | |
| | 320x180 | Up to 5 fps | | | |
| | | | | (* Up to 15 fps if Image capture mode is 15 fps | (* Up to 15 fps if Image capture mode is 15 fps |
| 25 fps mode | 3328x1872 | Up to 1 fps | Up to 12.5 fps | Up to 25 fps(*) | Up to 25 fps(*) |
| | 2560x1440 | Up to 2.1 fps | | | |
| | 1920x1080 | Up to 4.2 fps | | | |
| | 1280x720 | Up to 4.2 fps | | | |
| | 640x360 | Up to 4.2 fps | | | |
| | 320x180 | Up to 4.2 fps | | | |
| | | | | (* Up to 12.5 fps when Image capture mode is 12.5 fps | (* Up to 12.5 fps when Image capture mode is 12.5 fps |

Rapid PTZ cameras (X/S series, Image capture size: 6MP), Indoor PTZ cameras (Image capture size: 6MP)

| Image capture mode | Image capture size | Stream delivery | | | |
|-----------------------|--------------------|-----------------|------------------|--------------|----------------|
| | | On | | Off | |
| | | JPEG(1) | JPEG(2) | JPEG(1) | JPEG(2) |
| 16:9 mode(30fps mode) | 3328x1872 | Up to 1 fps | | Up to 30 fps | |
| | 2560x1440 | Up to 2 fps | | | |
| | 1920x1080 | Up to 5 fps | | | |
| | 1280x720 | Up to 5 fps | Up to 15 fps*1 | | Up to 30 fps*1 |
| | 640x360 | Up to 5 fps | | | |
| | 320x180 | Up to 5 fps | | | |
| 16:9 mode(25fps mode) | 3328x1872 | Up to 1 fps | | Up to 25 fps | |
| | 2560x1440 | Up to 2.1 fps | | | |
| | 1920x1080 | Up to 4.2 fps | | | |
| | 1280x720 | Up to 4.2 fps | Up to 12.5 fps*1 | | Up to 25 fps*1 |
| | 640x360 | Up to 4.2 fps | | | |
| | 320x180 | Up to 4.2 fps | | | |

*1 JPEG (2) is set to [1280x720] if [640x360] is not selected for the resolution set in Streams (1), Streams (2), Streams (3), Streams (4), and JPEG (1) and four resolutions are set.

Rapid PTZ camera (X/S series, Image capture size: 2MP), Multi-directional + PTZ (PTZ part)

| Image capture mode | Image capture size | Stream delivery | | | |
|--------------------------------------------------------------------------------------------------|--------------------|-----------------|----------------|--------------------------------------------------------|--------------------------------------------------------|
| | | On | | Off | |
| | | JPEG(1) | JPEG(2) | JPEG(1) | JPEG(2) |
| 16:9 mode(30fps mode) 16:9 mode(60fps mode) 4:3 mode(15fps mode) 4:3 mode(30fps mode) | 1920x1080 | Up to 5 fps | Up to 15 fps | Up to 30 fps | Up to 30 fps |
| | 1280x720 | | | (*) | (*) |
| | 640x360 | | | | |
| | 320x180 | | | | |
| | 2048x1536 | | | | |
| | 1280x960 | | | | |
| | VGA | | | (*) Up to 15 fps if Image capture mode is 15 fps | (*) Up to 15 fps if Image capture mode is 15 fps |
| | QVGA | | | | |
| 16:9 mode(25fps mode) 16:9 mode(50fps mode) 4:3 mode(12.5fps mode) 4:3 mode(25fps mode) | 1920x1080 | Up to 4.2 fps | Up to 12.5 fps | Up to 25 fps(*) | Up to 25 fps(*) |
| | 1280x720 | | | | |
| | 640x360 | | | | |
| | 320x180 | | | | |
| | 2048x1536 | | | | |
| | 1280x960 | | | | |
| | VGA | | | (*) Up to 12.5 fps when Image capture mode is 12.5 fps | (*) Up to 12.5 fps when Image capture mode is 12.5 fps |
| | QVGA | | | | |

Multi-directional camera

Please refer to the following for the relationship between your model and symbols and terminology.

→[1.2 Compatible models and symbols in this manual](#)

Multi-directional cameras (8-megapixel models)

| Imaging mode | Resolution | Stream delivery | | | |
|--------------------------------|------------|-----------------|----------------|-----------------|----------------|
| | | On | | Off | |
| | | JPEG(1) | JPEG(2) | JPEG(1) | JPEG(2) |
| 8 megapixels [16:9](15 fps) | 3840x2160 | Up to 1 fps | -(no function) | Up to 15 fps(*) | -(no function) |
| | 2560x1440 | Up to 2 fps | | | |

Multi-directional cameras (8-megapixel models) (continued)

| | | | | | |
|----------------------------------------------------------------------------------------------|-----------|---------------|----------------|--------------------------------------------------------------|----------------|
| mode) 8 megapixels [16:9](12.5 fps mode) | 1920x1080 | Up to 5 fps | | Up to 12.5 fps for the (*) imaging mode of 12.5 fps | |
| | 1280x720 | | | | |
| | 640x360 | | | | |
| | 320x180 | | | | |
| 8 megapixels [16:9](15 fps Dual mode) 8 megapixels [16:9](12.5 fps Dual mode) | 3840x2160 | Up to 1 fps | -(no function) | Up to 15 fps(*) | -(no function) |
| | 2560x1440 | Up to 2.1 fps | | | |
| | 1920x1080 | Up to 4.2 fps | | | |
| | 1280x720 | | | | |
| | 640x360 | | | | |
| | | | | | |
| | | | | Up to 12.5 fps for the (*) imaging mode of 12.5 fps | |

Multi-directional camera (5-megapixel model)

| Imaging mode | Resolution | Stream delivery | | | |
|-----------------------------------------|------------|-------------------------------------------------------------|----------------|--------------------------------------------------------------|----------------|
| | | On | | Off | |
| | | JPEG(1) | JPEG(2) | JPEG(1) | JPEG(2) |
| 5 megapixels [16:9](15fps mode) | 3072x1728 | Up to 1 fps | -(no function) | Up to 15 fps(*) | -(no function) |
| | 2560x1440 | Up to 2 fps(*) | | | |
| 5 megapixels [16:9](12.5fps mode) | | Up to 12.5 fps for the (*) imaging mode of 2.1 fps | | Up to 12.5 fps for the (*) imaging mode of 12.5 fps | |
| | 1920x1080 | Up to 5 fps(*) | | | |
| | 1280x720 | | | | |
| | 640x360 | | | | |
| | 320x180 | Up to 12.5 fps | | | |

Multi-directional camera (5-megapixel model) (continued)

| | | | | | |
|----------------------------------------------|-----------|-------------------------------------------------------------|----------------|--------------------------------------------------------------|----------------|
| | | for the (*) imaging mode of 4.2 fps | | | |
| 5 megapixels [16:9](15fps Quad mode) | 3072x1728 | Up to 1 fps | -(no function) | Up to 15 fps(*) | -(no function) |
| 5 megapixels [16:9](12.5fps Quad mode) | 2560x1440 | Up to 2 fps(*) | | | |
| | | Up to 12.5 fps for the (*) imaging mode of 2.1 fps | | | |
| | 1920x1080 | Up to 5 fps(*) | | Up to 12.5 fps for the (*) imaging mode of 12.5 fps | |
| | 1280x720 | | | | |
| | 640x360 | Up to 12.5 fps for the (*) imaging mode of 4.2 fps | | | |
| 5 megapixels [4:3](15fps mode) | 3072x2304 | Up to 1 fps | -(no function) | Up to 15 fps(*) | -(no function) |
| 5 megapixels [4:3](12.5fps mode) | 2560x1920 | Up to 2 fps(*) | | | |
| | | Up to 12.5 fps for the (*) imaging mode of 2.1 fps | | | |
| | 1280x960 | Up to 5 fps(*) | | Up to 12.5 fps for the (*) imaging mode of 12.5 fps | |
| | 640x480 | | | | |
| | 320x240 | Up to 12.5 fps for the (*) imaging mode of 4.2 fps | | | |
| 5 megapixels | 3072x2304 | Up to 1 fps | -(no function) | Up to 15 fps(*) | -(no function) |

2 Operation

2.3 Viewing images from a PC

Multi-directional camera (5-megapixel model) (continued)

| | | | | | |
|--------------------------------------------------------------------|-----------|--------------------------------------------------------------------------|--|-----------------------------------------------------|--|
| [4:3](15fps Quad mode) 5 megapixels [4:3](12.5fps Quad mode) | 2560x1920 | Up to 2 fps(*) Up to 12.5 fps for the (*) imaging mode of 2.1 fps | | | |
| | 1280x960 | Up to 5 fps(*) | | | |
| | 640x480 | Up to 12.5 fps for the (*) imaging mode of 4.2 fps | | | |
| | | | | Up to 12.5 fps for the (*) imaging mode of 12.5 fps | |

Multi-directional camera (4-megapixel model)

| Imaging mode | Resolution | Stream delivery | | | |
|------------------------------------------------------------------------------------|--------------------------------------------------|--------------------------------------------------|----------------|-------------------------------------------------|----------------|
| | | On | | Off | |
| | | JPEG(1) | JPEG(2) | JPEG(1) | JPEG(2) |
| 4 mega pixel [16:9](30fps mode) 4 mega pixel [16:9](25fps mode) | 2688x1520 | Up to 2 fps(*) | -(no function) | Up to 30 fps(*) | -(no function) |
| | 2560x1440 | Up to 25 fps for the (*) imaging mode of 2.1 fps | | Up to 25 fps for the (*) imaging mode of 25 fps | |
| | 1920x1080 | Up to 5 fps(*) | | | |
| | 1280x720 | | | | |
| | 640x360 | | | | |
| 320x180 | Up to 25 fps for the (*) imaging mode of 4.2 fps | | | | |
| 4 mega pixel [16:9](30fps Dual mode) 4 mega pixel [16:9](25fps Dual mode) | 2688x1520 | Up to 2 fps(*) | -(no function) | Up to 30 fps(*) | -(no function) |
| | 2560x1440 | Up to 25 fps for the (*) imaging mode of 2.1 fps | | | |
| | 1920x1080 | Up to 5 fps(*) | | | |

Multi-directional camera (4-megapixel model) (continued)

| | | | | | |
|--|----------|--------------------------------------------------|--|-------------------------------------------------|--|
| | 1280x720 | Up to 25 fps for the (*) imaging mode of 4.2 fps | | Up to 25 fps for the (*) imaging mode of 25 fps | |
| | 640x360 | | | | |

Compact Dome cameras

Please refer to the following for the relationship between your model and symbols and terminology.

→ [1.2 Compatible models and symbols in this manual](#)

Compact Dome cameras (X/S series, Image capture size: 4MP)

| Image capture mode | Image capture size | Stream delivery | | | |
|----------------------------------|--------------------|-----------------------------------|-----------------------|-----------------------|-----------------------|
| | | On | | Off | |
| | | JPEG(1) | JPEG(2) | JPEG(1) | JPEG(2) |
| 16:9 mode (2688x1520 30fps mode) | 2688x1520 | Up to 2 fps/2.1 fps* ¹ | – | Up to 30 fps/25 fps | Up to 30 fps/25 fps |
| | 1920x1080 | Up to 5 fps/4.2 fps* ¹ | Up to 15 fps/12.5 fps | | |
| 16:9 mode (2688x1520 25fps mode) | 1280x720 | | | | – |
| | 640x360 | | | | |
| | 320x180 | | | | |
| 16:9 mode(30fps mode) | 2560x1440 | Up to 2 fps/2.1 fps* ¹ | – | Up to 30 fps/25 fps | Up to 30 fps/25 fps |
| | 1920x1080 | Up to 5 fps/4.2 fps* ¹ | Up to 15 fps/12.5 fps | | |
| 16:9 mode(25fps mode) | 1280x720 | | | | – |
| | 640x360 | | | | |
| | 320x180 | | | | |
| 4:3 mode(30fps mode) | 1280x960 | Up to 5 fps/4.2 fps | – | Up to 30 fps/25 fps | Up to 30 fps/25 fps |
| | 640x480 | | Up to 15 fps/12.5 fps | | |
| 4:3 mode(25fps mode) | 320x240 | | – | | |
| | | | | | |
| 4:3 mode(15fps mode) | 2048x1536 | Up to 5 fps/4.2 fps | – | Up to 15 fps/12.5 fps | Up to 15 fps/12.5 fps |
| | 1280x960 | | Up to 15 fps/12.5 fps | | |
| 4:3 mode(12.5fps mode) | 640x480 | | | – | |
| | 320x240 | | | | |

2 Operation

2.3 Viewing images from a PC

*1 Only the same Image capture size as that set in streams (1), streams (2), streams (3), and JPEG (2) can be selected.

Compact Dome cameras (X/S series, Image capture size: 2MP)

| Image capture mode | Image capture size | Stream delivery | | | |
|------------------------------------------------|--------------------|-----------------------------------|-----------------------|-----------------------|-----------------------|
| | | On | | Off | |
| | | JPEG(1) | JPEG(2) | JPEG(1) | JPEG(2) |
| 16:9 mode(60fps mode) 16:9 mode(50fps mode) | 1920x1080 | Up to 5 fps/4.2 fps* ¹ | – | Up to 30 fps/25 fps | Up to 30 fps/25 fps |
| | 1280x720 | | Up to 15 fps/12.5 fps | | |
| | 640x360 | | | | |
| | 320x180 | – | | | |
| 16:9 mode(30fps mode) 16:9 mode(25fps mode) | 1920x1080 | Up to 5 fps/4.2 fps* ¹ | – | Up to 30 fps/25 fps | Up to 30 fps/25 fps |
| | 1280x720 | | Up to 15 fps/12.5 fps | | |
| | 640x360 | | | | |
| | 320x180 | – | | | |
| 4:3 mode(30fps mode) 4:3 mode(25fps mode) | 1280x960 | Up to 5 fps/4.2 fps | – | Up to 30 fps/25 fps | Up to 30 fps/25 fps |
| | 640x480 | | Up to 15 fps/12.5 fps | | |
| | 320x240 | | | | |
| 4:3 mode(15fps mode) 4:3 mode(12.5fps mode) | 2048x1536 | Up to 5 fps/4.2 fps | – | Up to 15 fps/12.5 fps | Up to 15 fps/12.5 fps |
| | 1280x960 | | Up to 15 fps/12.5 fps | | |
| | 640x480 | | | | |
| | 320x240 | – | | | |

Compact Dome cameras (U series, Image capture size: 4MP)

| Image capture mode | Image capture size | Stream delivery | | | |
|-------------------------------------|--------------------|---------------------|---------|----------------------|---------|
| | | On | | Off | |
| | | JPEG(1) | JPEG(2) | JPEG(1) | JPEG(2) |
| 16:9 mode (2688x1520 30fps mode) | 2688x1520 | Up to 3 fps/3.1 fps | – | Up to 10 fps/8.3 fps | – |
| | 1920x1080 | | | | |

Compact Dome cameras (U series, Image capture size: 4MP) (continued)

| | | | | | |
|----------------------------------------|-----------|--------------------------|--------------------------|-------------------------|--------------------------|
| 16:9 mode (2688x1520 25fps mode) | 1280x720 | | | | |
| | 640x360 | | | | |
| 16:9 mode(30fps mode) | 2560x1440 | Up to 3 fps/3.1 fps*1 | Up to 5 fps/4.2 fps*1 | Up to 10 fps/8.3 fps | Up to 30 fps/25 fps |
| | 1920x1080 | | | | |
| 16:9 mode(25fps mode) | 1280x720 | | | | |
| | 640x360 | | | | |
| | 320x180 | | | | |
| 4:3 mode(30fps mode) | 1280x960 | Up to 3 fps/3.1 fps | Up to 5 fps/4.2 fps | Up to 10 fps/8.3 fps | Up to 30 fps/25 fps |
| | 640x480 | | | | |
| 4:3 mode(25fps mode) | 320x240 | | | | |
| 4:3 mode(15fps mode) | 2048x1536 | Up to 3 fps/3.1 fps | Up to 5 fps/4.2 fps | Up to 10 fps/8.3 fps | Up to 15 fps/12.5 fps |
| | 1280x960 | | | | |
| 4:3 mode(12.5fps mode) | 640x480 | | | | |
| | 320x240 | | | | |

*1 If the frame rate of stream (1) and stream (2) is set to 30fps, it will be limited to a maximum of 1fps.

Compact Dome cameras (U series, Image capture size: 2MP)

| Image capture mode | Image capture size | Stream delivery | | | |
|--------------------------|-----------------------|------------------------|------------------------|-------------------------|------------------------|
| | | On | | Off | |
| | | JPEG(1) | JPEG(2) | JPEG(1) | JPEG(2) |
| 16:9 mode(30fps mode) | 1920x1080 | Up to 3 fps/3.1 fps | – | Up to 10 fps/8.3 fps | Up to 30 fps/25 fps |
| | | | | | |
| 16:9 mode(25fps mode) | 1280x720 | | Up to 5 fps/4.2 fps | | |
| | 640x360 | | | | |
| | 320x180 | | – | | |
| 4:3 mode(30fps mode) | 1280x960 | Up to 5 fps/4.2 fps | – | Up to 10 fps/8.3 fps | Up to 30 fps/25 fps |
| | 640x480 | | Up to 5 fps/4.2 fps | | |
| 4:3 mode(25fps mode) | 320x240 | | – | | |

New X fixed camera

Please refer to the following for the relationship between your model and symbols and terminology.

→1.2 Compatible models and symbols in this manual

New X fixed camera (Image capture size: 2MP)

| Image capture mode | Image capture size | Stream delivery | | | |
|------------------------------------------------|--------------------|---------------------|-----------------------|-----------------------|-----------------------|
| | | On | | Off | |
| | | JPEG(1) | JPEG(2) | JPEG(1) | JPEG(2) |
| 16:9 mode(30fps mode) 16:9 mode(25fps mode) | 1920x1080 | Up to 5 fps/4.2 fps | – | Up to 30 fps/25 fps | Up to 30 fps/25 fps |
| | 1280x720 | | Up to 15 fps/12.5 fps | | |
| | 640x360 | | | | |
| 16:9 mode(60fps mode) 16:9 mode(50fps mode) | 1920x1080 | Up to 5 fps/4.2 fps | – | Up to 30 fps/25 fps | Up to 30 fps/25 fps |
| | 1280x720 | | Up to 15 fps/12.5 fps | | |
| | 640x360 | | | | |
| 4:3 mode(30fps mode) 4:3 mode(25fps mode) | 2048x1536 | Up to 5 fps/4.2 fps | – | Up to 30 fps/25 fps | Up to 30 fps/25 fps |
| | 1280x960 | | Up to 15 fps/12.5 fps | | |
| | 640x480 | | | | |
| 4:3 mode(60fps mode) 4:3 mode(50fps mode) | 2048x1536 | Up to 5 fps/4.2 fps | – | Up to 15 fps/12.5 fps | Up to 15 fps/12.5 fps |
| | 1280x960 | | Up to 15 fps/12.5 fps | | |
| | 640x480 | | | | |
| 4:3 mode(30fps mode) 4:3 mode(25fps mode) | 2048x1536 | Up to 5 fps/4.2 fps | – | Up to 15 fps/12.5 fps | Up to 15 fps/12.5 fps |
| | 1280x960 | | Up to 15 fps/12.5 fps | | |
| | 640x480 | | | | |
| 4:3 mode(60fps mode) 4:3 mode(50fps mode) | 2048x1536 | Up to 5 fps/4.2 fps | – | Up to 15 fps/12.5 fps | Up to 15 fps/12.5 fps |
| | 1280x960 | | Up to 15 fps/12.5 fps | | |
| | 640x480 | | | | |

New X fixed camera (Image capture size: 5MP)

| Image capture mode | Image capture size | Stream delivery | | | |
|-----------------------|--------------------|-----------------------------------|-------------------------------------|---------------------|---------------------|
| | | On | | Off | |
| | | JPEG(1) | JPEG(2) | JPEG(1) | JPEG(2) |
| 16:9 mode(30fps mode) | 3072x1728 | Up to 1 fps* ¹ | – | Up to 30 fps/25 fps | Up to 30 fps/25 fps |
| | 2560x1440 | Up to 2 fps* ¹ | | | |
| 16:9 mode(25fps mode) | 1920x1080 | Up to 5 fps/4.2 fps* ¹ | Up to 15 fps/12.5 fps* ² | | |
| | 1280x720 | | | | |
| | 640x360 | | | | |

New X fixed camera (Image capture size: 5MP) (continued)

| | | | | | |
|------------------------------------------------|-------------------------------------------------------------------------|------------------------------------------------------------|------------------------------------|------------------------|------------------------|
| | 320x180 | | - | | |
| 16:9 mode(60fps mode) 16:9 mode(50fps mode) | -(no function) | -(no function) | -(no function) | -(no function) | -(no function) |
| 4:3 mode(30fps mode) 4:3 mode(25fps mode) | 3072x2304 2560x1920 1280x960 800x600 VGA 400x300 QVGA | Up to 1 fps*1 Up to 2 fps*1 Up to 5 fps/4.2 fps*1 | - Up to 15 fps/12.5 fps - | Up to 30 fps/25 fps | Up to 30 fps/25 fps |
| 4:3 mode(60fps mode) 4:3 mode(50fps mode) | -(no function) | -(no function) | -(no function) | -(no function) | -(no function) |

*1 Only the same Image capture size as configured in stream (1), stream (2), stream (3), stream (4), and JPEG (2) can be selected.

*2 JPEG (2) is set to [1280x720] if [640x360] is not selected for the resolution set in Streams (1), Streams (2), Streams (3), Streams (4), and JPEG (1) and four resolutions are set.

New X fixed camera (Image capture size: 6MP)

| Image capture mode | Image capture size | Stream delivery | | | |
|------------------------------------------------|-----------------------------------------------------------------------|------------------------------------------------------------|---------------------------------------|------------------------|------------------------|
| | | On | | Off | |
| | | JPEG(1) | JPEG(2) | JPEG(1) | JPEG(2) |
| 16:9 mode(30fps mode) 16:9 mode(25fps mode) | 3328x1872 2560x1440 1920x1080 1280x720 640x360 320x180 | Up to 1 fps*1 Up to 2 fps*1 Up to 5 fps/4.2 fps*1 | - Up to 15 fps/ 12.5 fps*2 - | Up to 30 fps/25 fps | Up to 30 fps/25 fps |

New X fixed camera (Image capture size: 6MP) (continued)

| | | | | | |
|-----------------------|----------------|----------------|----------------|----------------|----------------|
| 16:9 mode(60fps mode) | -(no function) | -(no function) | -(no function) | -(no function) | -(no function) |
| 16:9 mode(50fps mode) | | | | | |

*1 Only the same Image capture size as configured in stream (1), stream (2), stream (3), stream (4), and JPEG (2) can be selected.

*2 JPEG (2) is set to [1280x720] if [640x360] is not selected for the resolution set in Streams (1), Streams (2), Streams (3), Streams (4), and JPEG (1) and four resolutions are set.

New X fixed camera (Image capture size: 8MP)

| Image capture mode | Image capture size | Stream delivery | | | |
|-----------------------|--------------------|-----------------------|-------------------------|---------------------|---------------------|
| | | On | | Off | |
| | | JPEG(1) | JPEG(2) | JPEG(1) | JPEG(2) |
| 16:9 mode(30fps mode) | 3840x2160 | Up to 1 fps*1 | - | Up to 30 fps/25 fps | Up to 30 fps/25 fps |
| | 2560x1440 | Up to 2 fps*1 | | | |
| 16:9 mode(25fps mode) | 1920x1080 | Up to 5 fps/4.2 fps*1 | Up to 15 fps/12.5 fps*2 | | |
| | 1280x720 | | | | |
| | 640x360 | - | | | |
| | 320x180 | | | | |
| 16:9 mode(60fps mode) | -(no function) | -(no function) | -(no function) | -(no function) | -(no function) |
| 16:9 mode(50fps mode) | | | | | |

*1 Only the same Image capture size as configured in stream (1), stream (2), stream (3), stream (4), and JPEG (2) can be selected.

*2 JPEG (2) is set to [1280x720] if [640x360] is not selected for the resolution set in Streams (1), Streams (2), Streams (3), Streams (4), and JPEG (1) and four resolutions are set.

Corner cameras

Please refer to the following for the relationship between your model and symbols and terminology.

→[1.2 Compatible models and symbols in this manual](#)

Corner cameras (Image capture size: 5MP)

| Image capture mode | Image capture size | Stream delivery | | | |
|-----------------------|--------------------|-----------------------|-------------------------|---------------------|---------------------|
| | | On | | Off | |
| | | JPEG(1) | JPEG(2) | JPEG(1) | JPEG(2) |
| 16:9 mode(30fps mode) | 3072x1728 | Up to 1 fps*1 | - | Up to 30 fps/25 fps | Up to 30 fps/25 fps |
| | 2560x1440 | Up to 2 fps*1 | | | |
| 16:9 mode(25fps mode) | 1920x1080 | Up to 5 fps/4.2 fps*1 | Up to 15 fps/12.5 fps*2 | Up to 30 fps/25 fps | Up to 30 fps/25 fps |
| | 1280x720 | | | | |
| | 640x360 | | - | | |
| | 320x180 | | | | |
| 4:3 mode(30fps mode) | 3072x2304 | Up to 1 fps*1 | - | Up to 30 fps/25 fps | Up to 30 fps/25 fps |
| | 2560x1920 | Up to 2 fps*1 | | | |
| 4:3 mode(25fps mode) | 1280x960 | Up to 5 fps/4.2 fps*1 | Up to 15 fps/12.5 fps | Up to 30 fps/25 fps | Up to 30 fps/25 fps |
| | 800x600 | | | | |
| | VGA | | - | | |
| | 400x300 | | | | |
| | QVGA | | | | |

*1 Only the same Image capture size as configured in stream (1), stream (2), stream (3), stream (4), and JPEG (2) can be selected.

*2 JPEG (2) is set to [1280x720] if [640x360] is not selected for the resolution set in Streams (1), Streams (2), Streams (3), Streams (4), and JPEG (1) and four resolutions are set.

2.3.2 About live image pages



[Note:]

- Buttons and settings displayed on the live image page can be changed depending on the user's privileges. The user privileges are set in the [User mng.] [User auth.].

→ [13.1 \[User auth.\] to configure user-authentication](#)

- The design and layout of the screen may change.

2.3.2.1 Live image pages of Fixed Cameras

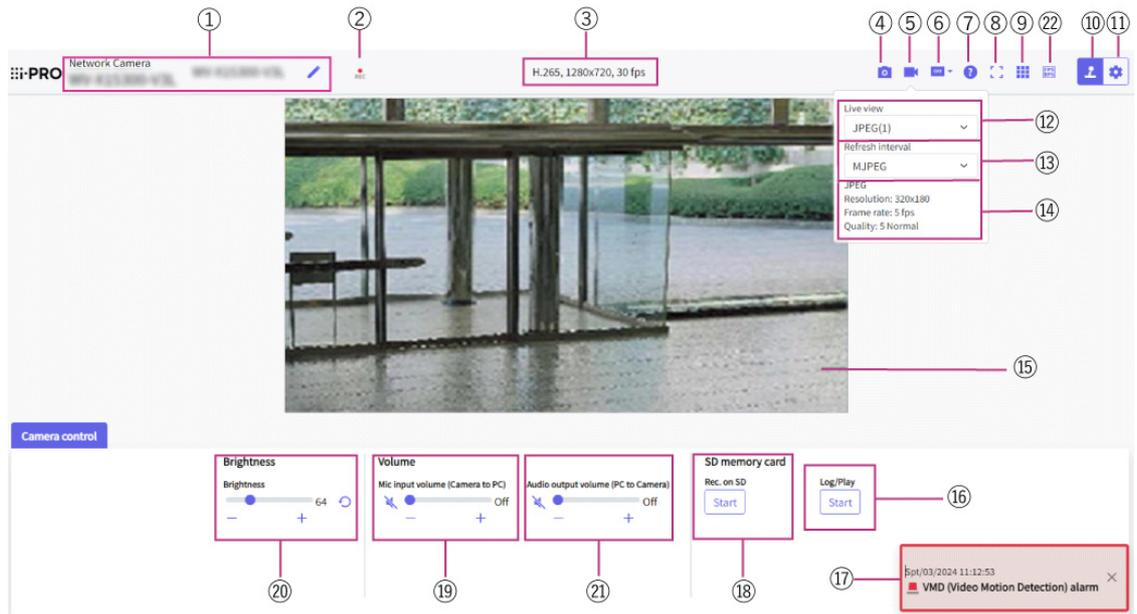

① **[Camera title]**

The title of the camera entered in [Camera title] on the [Basic] tab is displayed.
If you click the icon, the camera title becomes a text box and you can edit the string.



[Note:]

- The icon is not displayed on the following models.
Compact Dome cameras (U-series)

② **[SD save status display]**

Displays the storage status on the SD Memory Card.

When saving starts, the SD save status indicator turns red. The LED turns OFF when saving stops.

This is displayed when the [Save trigger] in the Setup menu is set to [Manual save] or [Schedule].

→8.2 [\[SD memory card\] for setting SD Memory Cards](#)

③ **[View Stream Information]**

Displays the compression method, Image capture size, and frame rates of live video.

④ **[Snap shot] BotaNs**

A snapshot (one still image) is acquired and the image is displayed in a separate window.

Right-click on the image to save the image using the web browser function.



[Note:]

- If it takes more than a certain period of time to acquire a snapshot depending on the network environment, the image may not be displayed.
 - If the specified Image capture size JPEG cannot be acquired, the Image capture size JPEG images that can be acquired are displayed.
- Therefore, if you snapshot a JPEG image and refer to it on a PC, the image size may differ from the displayed image size.

⑤ **[Stream selection display]Button**

You can toggle between displaying and hiding popup displays on the stream selection screen. In the streaming selection window, you can set the [Live only] etc.

⑥ **[Before/after image comparison switching]Button**

Click the icon to acquire and display the still image. You can compare the acquired still images as images before changing the image quality setting.

1:1:Displays the acquired still image and the latest image in the same size.

1:2:Displays the acquired still image and the latest image side by side so that the latest image is twice the size.

Off:Only the latest image is displayed.



[Note:]

- It cannot be displayed on the multi-screen display.

⑦ **[Support]Button**

Click the Support button to display our Technical Information website in a separate window. Our technical information website includes technical information, FAQ (Frequently Asked Questions), etc.

⑧ **Full Screen button**

A new window opens displaying the full screen image.

⑨ **[Grid display] buttons**

You can switch the grid view on/off that can be used to align the this product when using Extension software.

Our Technical Information Website for adjusted sizes for each Extension software we sell and provide<Control No.: C0320>It is listed.

⑩ **[Camera Control Panel Display]Button**

The camera control panel can be displayed or hidden. The camera control panel can be set to [Brightness], etc.

⑪ **[Set] buttons** (⚙)

You can view or hide the setting panel.

→ [3 Setting](#)

⑫ **[Stream]–[Live only] pull-down menu**

The image to be displayed in the main area can be selected from the following.

• [Stream(1)]/[Stream(2)]/[Stream(3)]/[Stream(4)]/[JPEG(1)]/[JPEG(2)]/[Multi-screen]

The main area images are displayed according to the settings in [Stream], [JPEG] and [Multi-screen].

You can also configure the [Initial display stream] of the [Image] tabs to show the first streams that appear when you are accessing the cameras. For [Multi-screen], you can set the [Initial display] in the [Multi-screen] tab.

→ [9 \[Image/Audio\] for setting images and sound files](#)



[Note:]

• When the Image capture size is [1280x720] or larger, the size of the browser screen may be smaller than the actual size.

⑬ **[Select Streams]–[Refresh Rate] pull-down menu**

This pull-down menu is displayed only when the JPEG image is displayed. Select how the JPEG image is displayed.

• [MJPEG] Displays JPEG images consecutively (MJPEG: Motion JPEG).

Updates images in · [Refresh interval : 1s]/[Refresh interval : 3s]/[Refresh interval : 5s]/[Refresh interval : 10s]/[Refresh interval : 30s]/[Refresh interval : 60s]: JPEG format (still image) at specified intervals.



[Note:]

• The JPEG format (still image) update interval may not be updated at the specified interval, depending on your network environment or PC.

⑭ **[Stream]–[View Stream Info]**

Displays the settings of the compression method, Image capture size, bit rate, frame rate, etc. of the live image.



[Note:]

- Displays the value set in the stream. The actual bit rate and frame rate vary depending on your network environment and PC.

⑮ **[Main area]**

Displays the camera image.

The current date and time are displayed according to the set [Time display format] and [Date/time display format].

→8.1 [\[Basic\] to perform basic settings](#)

The set text is displayed on the screen. The number of lines is two.

When H.265 is displayed, when the bit rate is high, it may be displayed at the refresh interval.



[Note:]

- Users with low access levels may temporarily change the display but do not affect the operation of the camera.
- When the shooting scene changes significantly depending on the PC, tiring (a phenomenon in which a part of the screen is misaligned) may occur due to constraints in the OS drawing process.
- When the data encryption function is enabled, the image cannot be viewed on the live screen. Use the corresponding equipment.
- When a high zoom factor image is displayed, the clicked position may not be the center of the image.
- As the tilt angle approaches 90 degrees, the difference between the specified position and the actual direction of movement will become larger, and the specified image angle may not be achieved.
- If the mouse is dragged to move to an angle that exceeds the rotational range of the camera, the camera moves to the position where it can be operated, and then the zoom factor is automatically adjusted.

⑯ **[Camera control panel]—[SD memory card]—[b]Display/play**

Clicking [Start] displays the log list and plays back the images stored on the SD Memory Card. Please refer to the following for details of the log list and how to play back the image.

→2.7 [Display the log list](#)

⑰ **[Alarm notification]**

When an alarm is generated, it is displayed as a popup. Clicking the [X] button resets the

output terminal and the display disappears.

→2.6 [Operation when alarm is generated](#)



[Note:]

- The alarm notification is not linked to the alarm notification operation such as recording to the SD Memory Card or mail transfer. Check the respective operation settings.

⑱ **[Camera control panel]—[SD memory card] —[Rec. on SD]**

This can only be set when [Save trigger] is set to [Manual save] on the [SD memory card] tabs.

You can manually save images to SD Memory Cards by clicking [Start]. To manually save images on the SD Memory Card, refer to the following.

→2.5 [Manually save images on the SD memory card](#)

⑲ **[Camera control panel]—[Voice (on PC)]**

This item can be set in the following settings.

- If [Audio input encoding format] is set to [AAC-LC]

—Buttons, +You can adjust the earpiece volume in four steps: [Off], [Low], [Middle], and [High] by clicking on buttons or by moving the volume cursor.

Click the Listen button to turn on/off the earpiece voice (heard on PC).

→3.8 [\[Audio\] for setting sound](#)



[Note:]

- When [Audio volume control mode] is set to [Adjust Mic input] in the Setup menu, the volume cursor is not displayed when using [Audio recording] or [Audio detection].
- When this product is restarted, the earpiece volume changed by the volume cursor returns to the earpiece volume set in the [Audio] tabs of the setting menus.
- On the screen, the volume cursor can be fine-tuned, but actually it is set to one of four levels of volume.
- If you open multiple camera browsers simultaneously on the same PC, you cannot hear the sound of the camera browser opened later. Access and check one by one.
- If network communication is unstable, voice reception may be stopped. In this case, restart voice reception by turning on and off the earpiece button.

→3.8 [\[Audio\] for setting sound](#)

⑳ **[Camera control panel]— [Brightness]**

It can be adjusted from 0 to 255. +Clicking the button brightens the image. – Click the button to darken the image. ○ Click the button to return to the default settings.

⑳ **[Camera control panel]–[Transmission voice (from PC)]**

This can only be set if [Audio transmission mode] is set to [Audio output] or [Interactive (Full-duplex)] [Interactive(Half-duplex)] in the configuration menus.

– Buttons, +Click the button or move the volume cursor to adjust the voice volume in four steps: Off/weak/medium/strong.

Click the talk button to turn on/off the talking voice (from PC).

→3.8 [\[Audio\] for setting sound](#)



[Note:]

- Transmission voice can only be used when connected with HTTPS.
- If [Interactive(Half-duplex)] is set while one user is talking, the other user's listening will be stopped and the earpiece button and the talk button will not be operable. If set to [Interactive(Full-duplex)], other users will not be able to use the call key.
- The maximum call duration per call is set on the [Audio] tabs of the video and audio pages. The call stops after the set continuous call time. If you want to make another call, click the call button.
- When the computer is restarted, the earpiece volume/voice volume changed by the volume cursor will return to the earpiece volume/voice volume set in the [Audio] tab of the image/voice page.
- On the screen, the volume cursor can be fine-tuned, but actually it is set to one of four levels of volume.

→3.8 [\[Audio\] for setting sound](#)

㉑ **Frame rate / bit rate display button**

Displays the frame rate and bit rate of the stream currently displayed in the live display.



[Note:]

This button is not displayed if the live image meets any of the following conditions.

- JPEG stream display
- JPEG refresh interval
- Multi-screen



[Note:]

- The following subjects cannot be focused with auto focus. Focus manually.
 - A subject that is bright or reflects strong light
 - Subject over water droplets or dirty glass
 - Remote and nearby subjects mixed together
 - Subjects (white walls, etc.) without contrast
 - A horizontal subject, such as a blind-an oblique subject-a dark subject

2.3.2.2 Live image pages of the PTZ camera



[Note:]

- There are two types of icons for live images, depending on the software version. Please check it against Live image pages window of your model.

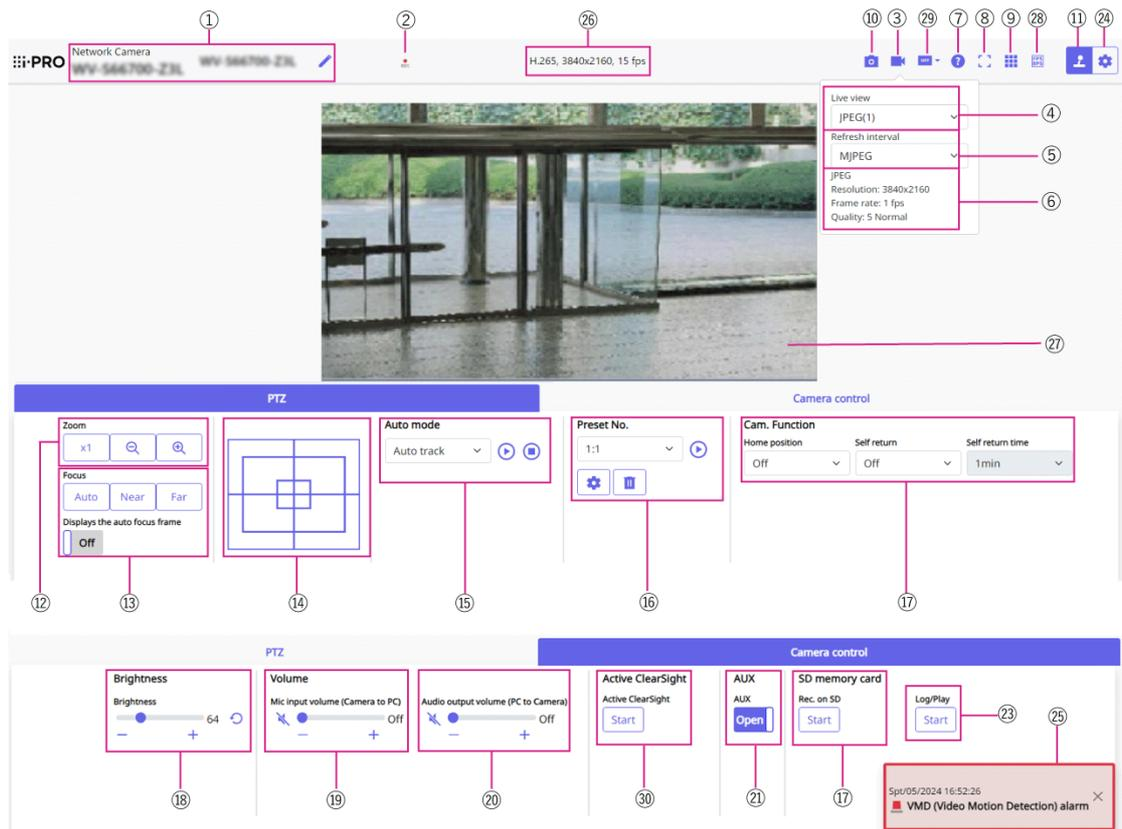

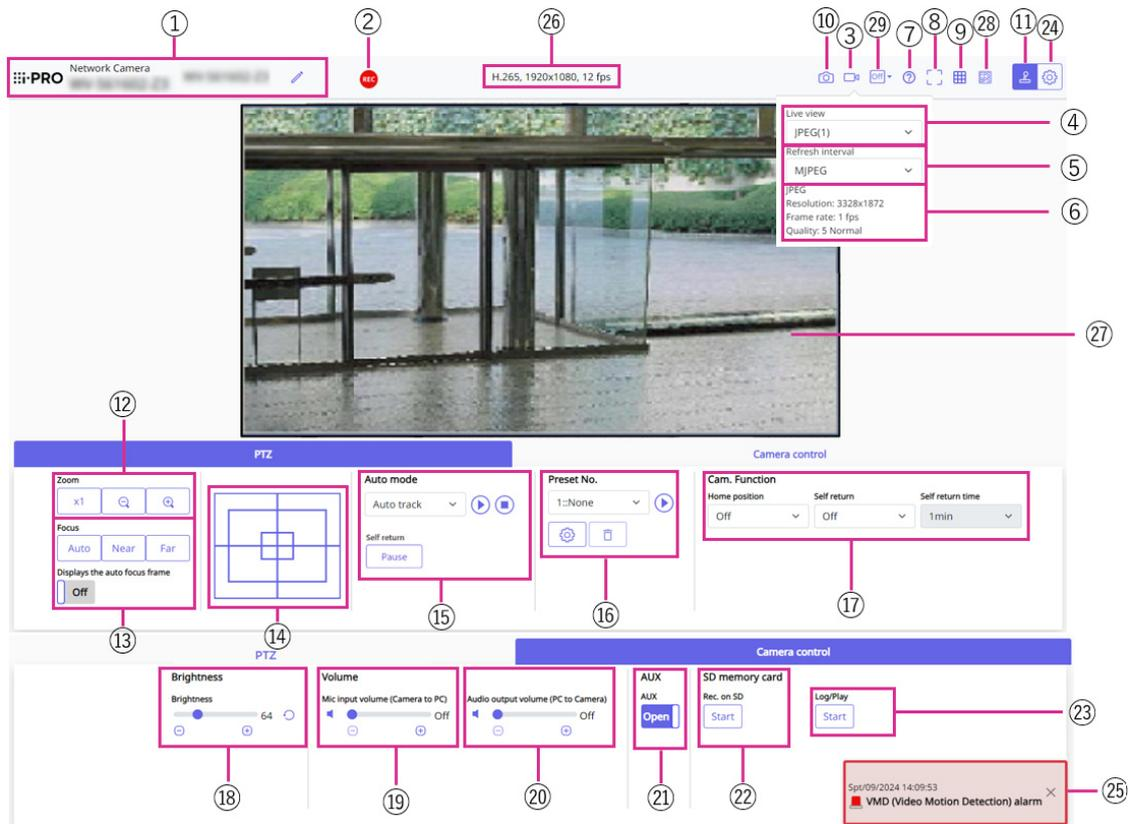

①[Camera title]

The title of the camera entered in [Camera title] on the [Basic] tab is displayed. If you click the icon, the camera title becomes a text box and you can edit the string.

②[SD save status display]

Displays the storage status on the SD Memory Card.

When saving starts, the SD save status indicator turns red. The LED turns OFF when saving stops.

This is displayed when the [Save trigger] in the Setup menu is set to [Manual] or [Schedule].

→8.2 [SD memory card] for setting SD Memory Cards

③[Stream selection display]Button

You can toggle between displaying and hiding popup displays on the stream selection screen. In the streaming selection window, you can set the [Live view] etc.

④ [Stream]–[Live only] pull-down menu—

The image to be displayed in the main area can be selected from the following.

- [Stream(1)]/[Stream(2)]/[Stream(3)]/[Stream(4)]/[JPEG(1)]/[JPEG(2)]/[Multi-screen]

The main area images are displayed according to the settings in [Stream], [JPEG] and [Multi-screen].

You can also configure the [Initial display stream] of the [Image] tabs to show the first

streams that appear when you are accessing the cameras. For [Multi-screen], you can set the [Initial display] in the [Multi-screen] tab.

→9 [Image/Audio] for setting images and sound files



[Note:]

- When the resolution is [1280x720] or higher, the size of the browser screen may be smaller than the actual size.

⑤[Select Streams–[Refresh Rate] pull-down menu

This pull-down menu is displayed only when the JPEG image is displayed. Select how the JPEG image is displayed.

- [MJPEG] Displays JPEG images consecutively (MJPEG: Motion JPEG).

Updates images in [Refresh interval : 1s]/[Refresh interval : 3s]/[Refresh interval : 5s]/
[Refresh interval : 10s]/[Refresh interval : 30s]/[Refresh interval : 60s]: JPEG format (still image) at specified intervals.



[Note:]

- The JPEG format (still image) update interval may not be updated at the specified interval, depending on your network environment or PC.

⑥[Stream]–[View Stream Info]

Displays the settings of the compression method, resolution, bit rate, frame rate, etc. of the live image being displayed.



[Note:]

- Displays the value set in the stream. The actual bit rate and frame rate vary depending on your network environment and PC.

⑦[Support]Button

Click the Support button to display our Technical Information website in a separate window.

Our technical information website includes technical information, FAQ (Frequently Asked Questions), etc.

⑧Full Screen button

A new window opens displaying the full screen image.

⑨[Grid display] buttons

You can switch the grid display ON/OFF that can be used to adjust the machine's position when using the function extension software.

For the size of adjustments for each of the functional extensions we sell and provide, our technical information website<Control No.: C0320>It is listed.

⑩[Snapshot] Buttons

A snapshot (one still image) is acquired and the image is displayed in a separate window. Right-click on the image to save the image using the web browser function.



[Note:]

- If it takes more than a certain period of time to acquire a snapshot depending on the network environment, the image may not be displayed.
 - If the specified resolution of JPEG cannot be acquired, the JPEG image with the available resolution is displayed.
- Therefore, if you snapshot a JPEG image and refer to it on a PC, the image size may differ from the displayed image size.
- [New X Fixed-8MP][New X Fixed-6MP][New X Fixed-5MP] This function is not available when [Image capture mode] is set to [60fps Mode] or [50fps Mode].

⑪[Camera Control Panel Display]Button()

The camera control panel can be displayed or hidden. The camera control panel can be set to [Brightness], etc.

⑫[PTZ panel]-[Zoom] buttons

Adjust the zoom manually.

- : Adjust the zoom factor in the [Wide angle] direction.
- **x1**: Zoom (magnification) 1.0 times.
- : Adjust the zoom factor in the [Telescope] direction.

⑬[PTZ panel]-[Focus]

Adjust the focus manually with the buttons.

- [Auto]: Automatically adjusts focus.
- [Near]: Adjust the focus to the [Near].
- [Far]: Adjust the focus to the [Far].
- [Displays the auto focus frame]: [On] and draw a frame on the image to adjust the focus (focus) to the frame.



[Note:]

- The following subjects cannot be focused with auto focus. Focus manually.
 - A subject that is bright or reflects strong light
 - Subject over water droplets or dirty glass
 - Remote and nearby subjects mixed together

- Subjects (white walls, etc.) without contrast
- A horizontal subject, such as a blind—an oblique subject—a dark subject

⑭ [PTZ Panel]—Control pad

Left-click the pads and buttons to adjust the horizontal and vertical position of the image (pan tilt).

The faster the camera operates, the faster the outside of the pad is clicked.

You can also drag and adjust the mouse. Zoom and focus by right-clicking.

Clicking on the upper half of the pad in the upper and lower directions will zoom in the telephoto, and clicking on the lower half will zoom in the wide angle. Clicking on the left half in the left and right directions will bring the focus (focus) close to you, and clicking on the right half will bring it far away. You can also adjust the zoom by using the mouse wheel.

⑮ [PTZ panel]—[Auto mode]

Selecting Operation from the pull-down menu starts the selected operation.

When panning, tilting, zooming, or focusing is performed, or when the operation set in [Self return] or [Camera action on alarm] starts, it is also terminated.

→10.1 [Cam. Function] for setting the operation of cameras

→12.1 [Alarm] to set alarm operation

· [Auto track]: Automatically tracks objects when they are detected.

→10.3 Set auto-tracking (Auto-tracking screen)

· [Auto pan]: Automatically rotates the pre-set range between the start and end positions of the pan. The pivot operation continues even after the zoom and focus operations (when the [x1] button of the [Zoom] button is clicked, the pivot operation stops).

→10.2.3 Set auto pan (Auto pan setting screen)

· [Preset sequence 1]/[Preset sequence 2]/[Preset sequence 3] moves the pre-registered preset positions from the lowest to the lowest.

→10.2.2 Set the preset sequence setting (preset sequence setting screen)



[Note:]

· If the content of [Self return] operates at the time set by [Self return time] during the auto mode operation, the auto mode operation stops.

→10.1 [Cam. Function] for setting the operation of cameras

⑯ [PTZ-panel]—[Preset]

Select the preset position from the pull-down menu and click the [Move] button to move the camera's orientation to the preset position registered beforehand.

→10.2.2 Set the preset sequence setting (preset sequence setting screen)

[H] next to the number indicates [HomePosition]. Select [HomePosition] to move the orientation of the camera to the home position.

→10.1 [\[Cam. Function\] for setting the operation of cameras](#)

If [Preset ID (0 – 9,A – Z)] is registered, the position name is displayed next to the number.

⑰PTZ-Panel-[Cam. Function]

[Home position]

The preset [Preset position] can be set as a [HomePosition]. When set to [HomePosition], [H] is displayed next to the preset position number.

→10.2.1 [Set the preset position \(preset position setting screen\)](#)



[Note:]

- If you want to move to the home position when the power is turned on, set [HomePosition] to [Self return].

[Self return]

When the time set by [Self return time] has elapsed after the manual operation is completed, the camera can automatically return to the operation mode set by the camera.



[Note:]

- If you want to perform the above operations when turning on the power, it is convenient to use the self-return function.
- The self-return function works even when the setting menu is displayed.
- [Patrol] can be set only when patrols are set.
→10.2.4 [Set patrol \(Patrol function setting screen\)](#)
- Only [Patrol 1] can be set for “Patrol”. [Patrol 2], [Patrol 3] and [Patrol 4] are unavailable.
→10.2.4 [Set patrol \(Patrol function setting screen\)](#)
- [Preset sequence] can be set only when preset sequence is set.
→10.2.2 [Set the preset sequence setting \(preset sequence setting screen\)](#)

[Self return time]

After the manual operation is completed, select the time before returning to the operation set by [Self return].

⑱[Camera control panel]- [Brightness]

It can be adjusted from 0 to 255. +Clicking the button brightens the image. - Click the button to darken the image. ↺Click the button to return to the default settings.

⑲ [Camera control panel]—[Transmission voice (from PC)]

This can only be set if [Audio transmission mode] is set to [Audio output] or [Interactive(Full-duplex)] [Interactive(Half-duplex)] in the configuration menus.

—Buttons, +Click the button or move the volume cursor to adjust the voice volume in four steps: Off/weak/medium/strong.

Click the talk button to turn on/off the talking voice (from PC).

→3.8 [\[Audio\] for setting sound](#)



[Note:]

- Transmission voice can only be used when connected with HTTPS.
- If [Interactive(Half-duplex)] is set while one user is talking, the other user's listening will be stopped and the earpiece button and the talk button will not be operable. If set to [Interactive(Full-duplex)], other users will not be able to use the call key.
- The maximum call duration per call is set on the [Audio] tabs of the video and audio pages. The call stops after the set continuous call time. If you want to make another call, click the call button.
- When the computer is restarted, the earpiece volume/voice volume changed by the volume cursor will return to the earpiece volume/voice volume set in the [Audio] tab of the image/voice page.
- On the screen, the volume cursor can be fine-tuned, but actually it is set to one of four levels of volume.

→3.8 [\[Audio\] for setting sound](#)

⑳ [Camera control panel]—[Voice (on PC)]

This item can be set in the following settings.

· If [Audio transmission mode] is set to [Mic input] or [Interactive(Full-duplex)] [Interactive(Half-duplex)]

· If [Audio input encoding format] is set to [AAC-LC]

—Buttons, +You can adjust the earpiece volume in four steps: [Off], [Low], [Middle], and [High] by clicking on buttons or by moving the volume cursor.

Click the Listen button to turn on/off the earpiece voice (heard on PC).

→3.8 [\[Audio\] for setting sound](#)



[Note:]

- When [Audio volume control mode] is set to [Adjust Mic input] in the Setup menu, the volume cursor is not displayed when using [Audio recording] or [Audio detection].
- When the computer is restarted, the earpiece volume changed by the volume cursor returns to the earpiece volume set in the [Audio] tabs of the setting menus.
- On the screen, the volume cursor can be fine-tuned, but actually it is set to one of four levels of volume.
- If you open multiple camera browsers simultaneously on the same PC, you cannot hear the sound of the camera browser opened later. Access and check one by one.
- If network communication is unstable, voice reception may be stopped. In this case, restart voice reception by turning on and off the earpiece button.
→3.8 [\[Audio\] for setting sound](#)

②**[Camera control panel]–[AUX] buttons**

This setting is available only when [Terminal 3] of [Alarm] is set to [AUX output] in the Advanced menu.

- [Open]: The aux terminal is open.
- [Close]: The aux terminal closes.

→7.3.2 [Alarm: Sets terminal and operation detection \(alarm setting screen\)](#)



[Note:]

- The names of [AUX], [Open], and [Close] can be changed.
→12.3 [\[Alarm\] to change the aux name](#)

②**[SD memory card]–[b]Display/play**

Clicking [Start] displays the log list and plays back the images stored on the SD Memory Card. Please refer to the following for details of the log list and how to play back the image.

→2.7 [Display the log list](#)

③**[SD memory card] –[Rec. on SD]**

This can only be set when [Save trigger] is set to [Manual save] on the [SD memory card] tabs. You can manually save images to SD Memory Cards by clicking [Start]. To manually save images on the SD Memory Card, refer to the following.

→2.5 [Manually save images on the SD memory card](#)

④**[Set] buttons(⚙)**

You can view or hide the setting panel.

→3 [Setting](#)

②⑤[Alarm notification]

When an alarm is generated, it is displayed as a popup. Clicking the [X] button resets the output terminal and the display disappears.

→2.6 [Operation when alarm is generated](#)



[Note:]

- The alarm notification is not linked to the alarm notification operation such as recording to the SD Memory Card or mail transfer. Check the respective operation settings.

②⑥[View Stream Information]

Displays the compression method, resolution, and frame rate of live video.

②⑦[Main area]

Displays the camera image.

The current date and time are displayed according to the set [Time display format] and [Date/time display format].

→8.1 [\[Basic\] to perform basic settings](#)

The set text is displayed on the screen. The number of lines is two.

When H.265 is displayed, when the bit rate is high, it may be displayed at the refresh interval.

In the main area, clicking the desired position for the center of the field angle moves the camera's direction to the center of the clicked position.

If you select the area you want to view by dragging the mouse, the camera will move to a position centered on the selected area and the zoom factor will be automatically adjusted.

You can also adjust the zoom in the mouse wheel operation.

Right-clicking in the main area starts automatic tracking of objects in the clicked position.

Depending on the object to be tracked and the surrounding environment, the watch may not operate properly.



[Note:]

- Users with low access levels may temporarily change the display but do not affect the operation of the camera.
- When the shooting scene changes significantly depending on the PC, tiring (a phenomenon in which a part of the screen is misaligned) may occur due to constraints in the OS drawing process.
- When the data encryption function is enabled, the image cannot be viewed on the

live screen. Use the corresponding equipment.

- When a high zoom factor image is displayed, the clicked position may not be the center of the image.
- As the tilt angle approaches 90 degrees, the difference between the specified position and the actual direction of movement will become larger, and the specified image angle may not be achieved.
- If the mouse is dragged to move to an angle that exceeds the rotational range of the camera, the camera moves to the position where it can be operated, and then the zoom factor is automatically adjusted.

⑳ Frame rate / bit rate display button

Displays the frame rate and bit rate of the stream currently displayed in the live display.



[Note:]

This button is not displayed if the live image meets any of the following conditions.

- JPEG stream display
- JPEG refresh interval
- Multi-screen

㉑ [Before/after image comparison switching]Button

Click the icon to acquire and display the still image. You can compare the acquired still images as images before changing the image quality setting.

1:1:Displays the acquired still image and the latest image in the same size.

1:2:Displays the acquired still image and the latest image side by side so that the latest image is twice the size.

Off:Only the latest image is displayed.



[Note:]

- It cannot be displayed on the multi-screen display.

2.3.2.3 Live image pages of Multi-directional Cameras

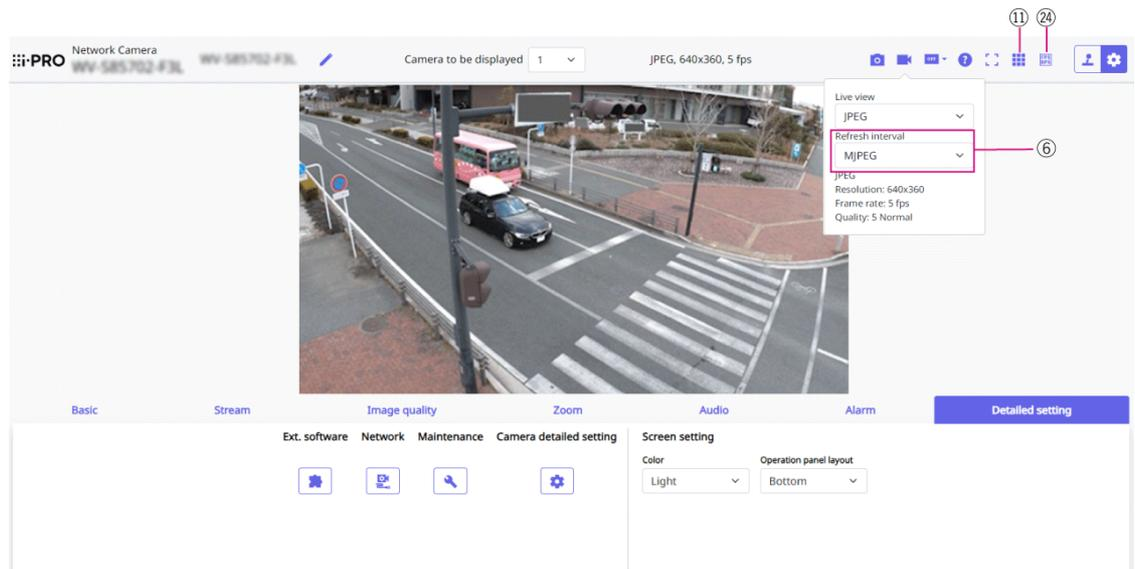

①[Camera title]

The title of the camera entered in [Camera title] on the [Basic] tab is displayed.

If you click the icon, the camera title becomes a text box and you can edit the string.

②[SD Storage Status Display]

Displays the storage status on the SD Memory Card.

When saving starts, the SD save status indicator turns red. The LED turns OFF when saving stops.

This is displayed when the [Save trigger] in the Setup menu is set to [Manual] or [Schedule].

→8.2 [SD memory card] for setting SD Memory Cards

③[Camera to be displayed]

Select the camera to be displayed in the main area.

- [Dual]: Displays images of cameras 1 and 2 in two sections.
- 1: Displays camera 1 images.
- 2: Displays camera 2 images.



[Note:]

- This item is not displayed when [Image capture mode] is in Dual mode.

④[Stream Selection Display] button

You can toggle between displaying and hiding popup displays on the stream selection screen. In the streaming selection window, you can set the [Live view] etc.

⑤[Select Streams]-[Live view] pull-down menu

The image to be displayed in the main area can be selected from the following.

[Dual]When selected: [Streams(2)]/ [JPEG]

When 1 or 2 is selected: [Stream(1)]/ [Stream(2)]/[JPEG]

The main area image is displayed according to the settings in streams (1) to (2) and JPEG.

You can also configure the [Initial display stream] of the [Stream] tabs to show the first streams that appear when you are accessing the cameras.

→3.3 [\[Stream\] for setting images](#)



[Note:]

- This item is not displayed when [Image capture mode] is in Dual mode.
- When 1 or 2 is selected, the size of the browser may be smaller than the actual size, depending on the size of the browser when the Image capture size is [1280x720] or larger, or when [Image capture mode] is Dual mode. When [Dual] is selected, the size of the browser may be smaller than the actual size of the browser in any Image capture size.

⑥[Select Streams]-[Refresh Rate] pull-down menu

This pull-down menu is displayed only when the JPEG image is displayed. Select how the JPEG image is displayed.

[MJPEG]:Displays a JPEG image as a series (MJPEG: Motion JPEG).

[Refresh interval : 1s]/[Refresh interval : 3s]/[Refresh interval : 5s]/[Refresh interval : 10s]/[Refresh interval : 30s]/ [Refresh interval : 60s]:Updates JPEG images (still images) at specified intervals.



[Note:]

- The JPEG format (still image) update interval may not be updated at the specified interval, depending on your network environment or PC.
- If [Dual] is selected in the [Live only] pull-down menu, [Refresh interval : 1s] and [Refresh interval : 3s] cannot be selected.

⑦[Select Streams]-[Layout] pull-down menu

This pull-down menu is displayed only when it is displayed in [Dual].

Select the display layout of the camera image to be displayed in the main area from the left/right/up/down view.



[Notice:]

When [Dual] is selected in [Layout], select [Camera 1-Camera 2] or [Camera 2-Camera 1] in the order in which the cameras are displayed in [Camera display order].

⑧[Select stream]-[View Stream Information]

Displays the settings of the compression method, resolution, bit rate, frame rate, etc. of the live image being displayed.



[Note:]

- Displays the value set in the stream. The actual bit rate and frame rate vary depending on your network environment and PC.

⑨[Support button]

Click the Support button to display our Technical Information website in a separate window. Our technical information website includes technical information, FAQ (Frequently Asked Questions), etc.

⑩[Full Screen Display Button]

A new window opens displaying the full screen image.

⑪[Grid display] buttons

You can switch the grid display ON/OFF that can be used to adjust the machine's position when using the function extension software.

For the size of adjustments for each of the functional extensions we sell and provide, our technical information website<Control No.: C0320>It is listed.

⑫[Snapshot button]

A snapshot (one still image) is acquired and the image is displayed in a separate window.
Right-click on the image to save the image using the web browser function.



[Note:]

- If it takes more than a certain period of time to acquire a snapshot depending on the network environment, the image may not be displayed.
- If the specified resolution of JPEG cannot be acquired, the JPEG image with the available resolution is displayed. Therefore, if you snapshot a JPEG image and refer to it on a PC, the image size may differ from the displayed image size.

⑬[Camera Control Panel View button]()

The camera control panel can be displayed or hidden. The camera control panel can be set to [Brightness], etc.

⑭[Camera Control Panel]–[Brightness]

It can be adjusted from 0 to 255. +Clicking the button brightens the image. –Click the button to darken the image. ↻Click the button to return to the default settings. This cannot be set when [Dual] is displayed.



[Note:]

- This item is not displayed when [Image capture mode] is in Dual mode.

⑮[Camera Control Panel]–[Transmission voice (from PC)]

This can only be set if [Audio transmission mode] is set to [Audio output] or [Interactive(Full-duplex)] [Interactive(Half-duplex)] in the configuration menus.

→3.8 [\[Audio\] for setting sound](#)

–Buttons, +By clicking on the buttons or by moving the volume cursors, you can adjust the volume of the call by four levels: [Off], [Low], [Middle] and [High].

Click the talk button to turn on/off the talking voice (from PC).



[Note:]

- Transmission voice can only be used when connected with HTTPS.
- If [Interactive(Half-duplex)] is set while one user is talking, the other user's listening will be stopped and the earpiece button and the talk button will not be operable. If set to [Interactive(Full-duplex)], other users will not be able to use the call key.
- The maximum call duration per call is set on the [Audio] tabs of the video and

audio pages. The call stops after the set continuous call time. If you want to make another call, click the call button.

- When the computer is restarted, the earpiece volume/voice volume changed by the volume cursor will return to the earpiece volume/voice volume set in the [Audio] tab of the image/voice page.
→3.8 [Audio] for setting sound
- On the screen, the volume cursor can be fine-tuned, but actually it is set to one of four levels of volume.

⑩[Camera Control Panel]-[Voice (on PC)]

This item can be set in the following settings.

→3.8 [Audio] for setting sound

- If [Audio transmission mode] is set to [Mic input] or [Interactive(Full-duplex)] [Interactive (Half-duplex)]
- If [Audio input encoding format] is set to [AAC-LC]
—Buttons, +You can adjust the earpiece volume in four steps: [Off], [Low], [Middle], and [High] by clicking on buttons or by moving the volume cursor.

Click the Listen button to turn on/off the earpiece voice (heard on PC).



[Note:]

- When [Audio volume control mode] is set to [Adjust Mic input] in the Setup menu, the volume cursor is not displayed when using [Audio recording] or [Audio detection].
→3.8 [Audio] for setting sound
- When the computer is restarted, the earpiece volume changed by the volume cursor returns to the earpiece volume set in the [Audio] tabs of the setting menus.
→3.8 [Audio] for setting sound
- On the screen, the volume cursor can be fine-tuned, but actually it is set to one of four levels of volume.
- If you open multiple camera browsers simultaneously on the same PC, you cannot hear the sound of the camera browser opened later. Access and check one by one.
- If network communication is unstable, voice reception may be stopped. In this case, restart voice reception by turning on and off the earpiece button.

⑪[Camera Control Panel]-[AUX] Buttons

This setting is available only when [Terminal 3] of [Alarm] is set to [AUX output] in the

Advanced menu.

→7.3.2 [Alarm: Sets terminal and operation detection \(alarm setting screen\)](#)

[Open] buttons:The AUX terminal is open.

[Close] buttons:The AUX terminal will be closed.



[Note:]

• The names of [AUX], [Open], and [Close] can be changed.

→12.3 [\[Alarm\] to change the aux name](#)

⑱[Camera Control Panel]–[Playback of recording (Log disp.)]

Clicking [Start] displays the log list and plays back the images stored on the SD Memory Card.

Please refer to the following for details of the log list and how to play back the image.

→2.7 [Display the log list](#)

⑲[Camera Control Panel]–[Record/Play (SD Memory Card)]

This can only be set when [Save trigger] is set to [Manual save] on the [SD memory card] tabs.

You can manually save images to SD Memory Cards by clicking [Start]. To manually save images on the SD Memory Card, refer to the following.

→2.5 [Manually save images on the SD memory card](#)

⑳[Set] buttons()

You can view or hide the setting panel.

→3 [Setting](#)

㉑[Alarm notification]

When an alarm is generated, it is displayed as a popup. Clicking the [X] button resets the output terminal and the display disappears.

→2.6 [Operation when alarm is generated](#)



[Note:]

• The alarm notification is not linked to the alarm notification operation such as recording to the SD Memory Card or mail transfer. Check the respective operation settings.

㉒[View Stream Information]

Displays the compression method, resolution, and frame rate of live video.

㉓[Main area]

Displays the camera image.

The current date and time are displayed according to the set [Time display format] and [Date/time display format].

→8.1 [Basic] to perform basic settings

The set text is displayed on the screen. The number of lines is two.

When H.265 is displayed, when the bit rate is high, it may be displayed at the refresh interval.



[Note:]

- Users with low access levels may temporarily change the display but do not affect the operation of the camera.
- When the shooting scene changes significantly depending on the PC, tiring (a phenomenon in which a part of the screen is misaligned) may occur due to constraints in the OS drawing process.
- When the data encryption function is enabled, the image cannot be viewed on the live screen. Use the corresponding equipment.

④Frame rate / bit rate display button

Displays the frame rate and bit rate of the stream currently displayed in the live display.



[Note:]

- This button is not displayed if the live image meets any of the following conditions.
- JPEG stream display
 - JPEG refresh interval
 - [Dual] display

2.3.2.4 Live image pages of Multi-directional/PTZ integrated cameras



[Note:]

- [MULTI_PTZ] The live image pages for each camera are displayed by accessing the IP addresses set for the PTZ camera and the Multi-directional camera.

PTZ camera

2 Operation
 2.3 Viewing images from a PC

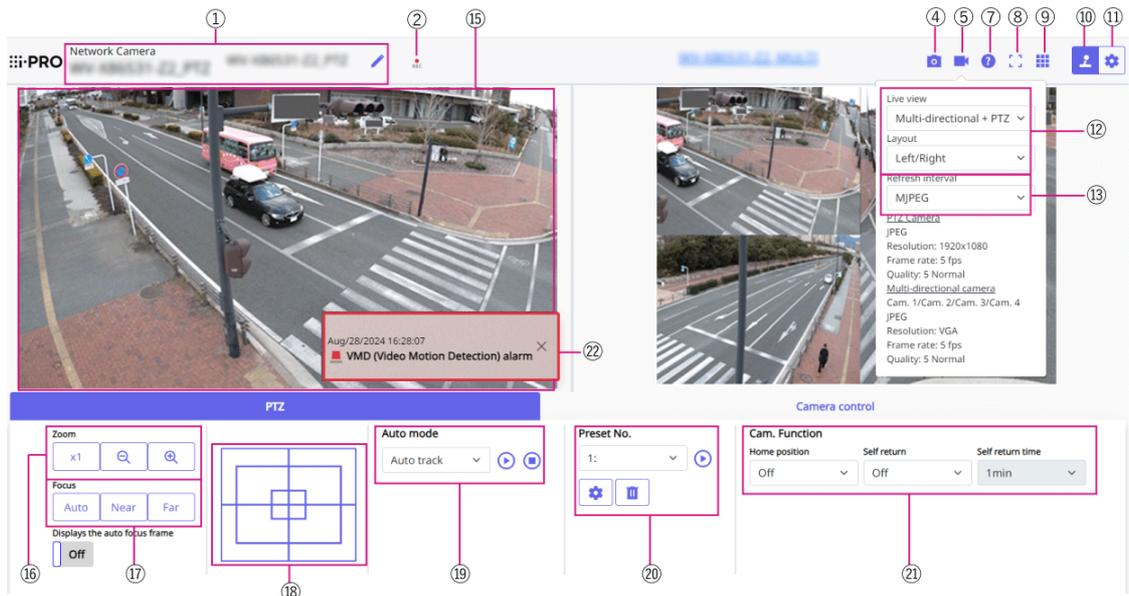

Multi-directional camera

2 Operation
 2.3 Viewing images from a PC

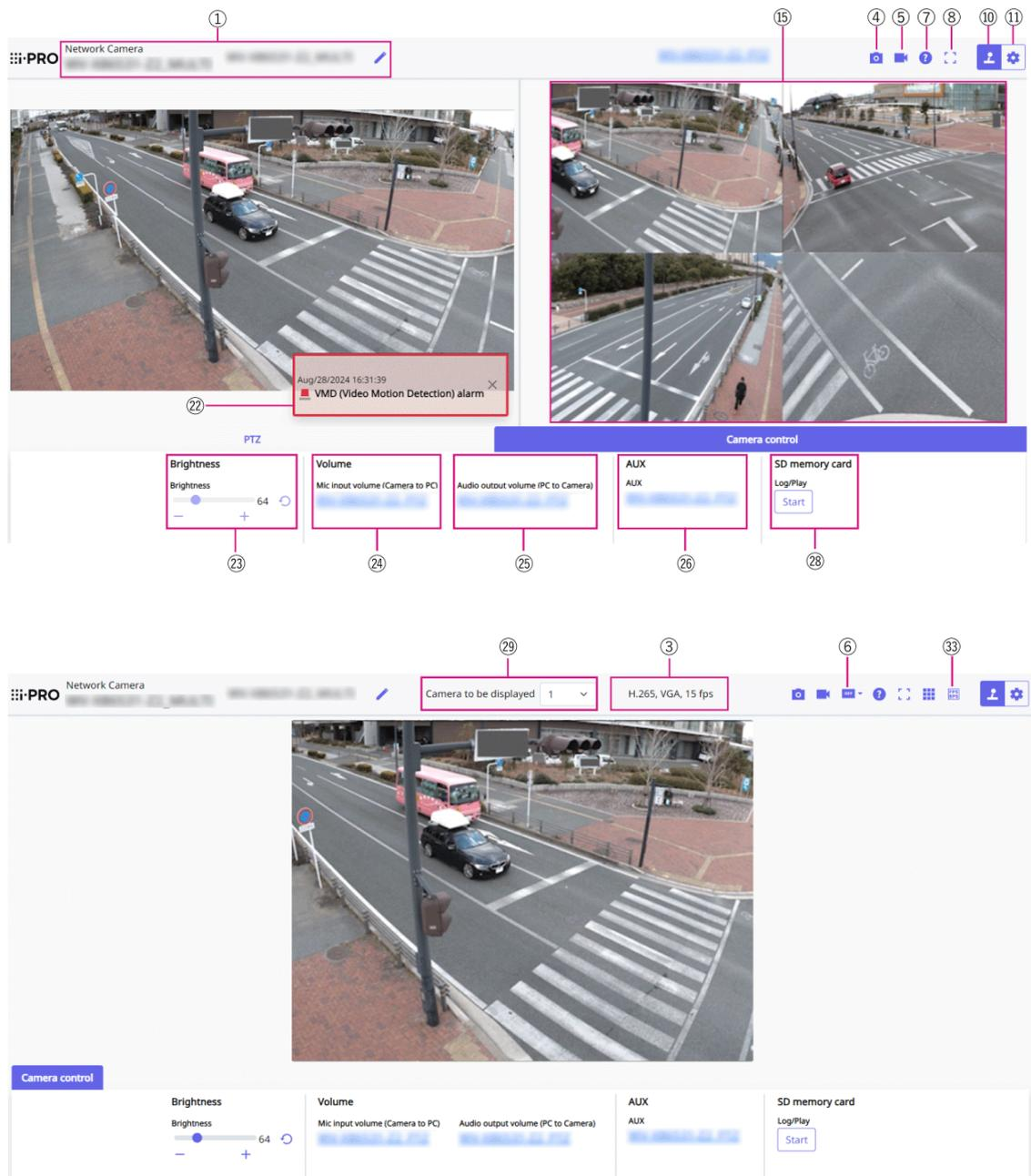

①[Camera title]

The title of the camera entered in [Camera title] on the [Basic] tab is displayed.
 If you click the icon, the camera title becomes a text box and you can edit the string.

②[SD Storage Status Display]

Displays the storage status on the SD Memory Card.

When saving starts, the SD save status indicator turns red. The LED turns OFF when saving stops.

This is displayed when the [Save trigger] in the Setup menu is set to [Manual] or [Schedule].

→8.2 [SD memory card] for setting SD Memory Cards

③[View Stream Information]

Displays the compression method, resolution, and frame rate of live video.

④[Snapshot button]

A snapshot (one still image) is acquired and the image is displayed in a separate window.

Right-click on the image to save the image using the web browser function.



[Note:]

- If it takes more than a certain period of time to acquire a snapshot depending on the network environment, the image may not be displayed.
 - If the specified resolution of JPEG cannot be acquired, the JPEG image with the available resolution is displayed.
- Therefore, if you snapshot a JPEG image and refer to it on a PC, the image size may differ from the displayed image size.

⑤[Stream Selection Display button]

You can toggle between displaying and hiding popup displays on the stream selection screen. In the streaming selection window, you can set the [Live view] etc.

⑥[Before/after image comparison toggle button]

Click the icon to acquire and display the still image. You can compare the acquired still images as images before changing the image quality setting.

[1] Displays the downloaded still image and the latest image in the same size.

[1]:The latest image is doubled in size between the downloaded still image and the latest image.

[View]: Only the latest image is displayed.

⑦[Support button]

Click the Support button to display our Technical Information website in a separate window. Our technical information website includes technical information, FAQ (Frequently Asked Questions), etc.

⑧[Full Screen Display Button]

A new window opens displaying the full screen image.

⑨[Grid display] buttons

You can switch the grid display ON/OFF that can be used to adjust the machine's position when using the function extension software.

For the size of adjustments for each of the functional extensions we sell and provide, our technical information website<Control No.: C0320>It is listed.

⑩[Camera Control Panel View] button()

The camera control panel can be displayed or hidden. The camera control panel can be set to

[Brightness], etc.

⑪ **[Set] buttons** (⚙)

You can view or hide the setting panel.

→ [3 Setting](#)

⑫ **[Select Streams]–[Live view] pull-down menu**

The image to be displayed in the main area can be selected from the following.

PTZ camera

[Multi-directional + PTZ]/[Stream(1)]/[Stream(2)]/[Stream(3)]/[Stream(4)]/JPEG(1)/JPEG(2)

Multi-directional camera

[Camera to be displayed]When [Quad] [Triple] is selected:[Multi-directional + PTZ]/[Stream (2)]/JPEG

[Camera to be displayed]When 1, 2, 3, or 4 are selected:[Multi-directional + PTZ]/[Stream(1)]/[Stream(2)]/JPEG

The main area image is displayed according to the settings in the stream and JPEG.

You can also configure the [Initial display stream] of the [Image] tabs to show the first streams that appear when you are accessing the cameras.

→ [3.3 \[Stream\] for setting images](#)



[Note:]

- When the resolution is [1280x720] or higher, the size of the browser screen may be smaller than the actual size.
- [MULTI] This item is not displayed when [Image capture mode] is in quad mode.
- [MULTI] When selecting 1, 2, 3, or 4, if the resolution is [1280x720] or higher or [Image capture mode] is Quad-mode, the size of the browser screen may be smaller than the actual size. When [Quad] [Triple] is selected, the size of the browser screen may be smaller than the actual size at any resolution.

⑬ **[Select Streams]–[Refresh Rate] pull-down menu**

This pull-down menu is displayed only when the JPEG image is displayed. Select how the JPEG image is displayed.

MJPEG:Displays a JPEG image as a series (MJPEG: Motion JPEG).

[Still image updates: 1 second]/[Refresh interval : 3s]/[Refresh interval : 5s]/[Refresh interval : 10s]/[Refresh interval : 30s]/ [Refresh interval : 60s]:Updates JPEG images (still images) at specified intervals.



[Note:]

- The JPEG format (still image) update interval may not be updated at the specified interval, depending on your network environment or PC.
- [MULTI] When [Quad] [Triple] is selected in the [Live view] pull-down menu, [Refresh interval : 1s] and [Refresh interval : 3s] cannot be selected.

⑭ **[Select stream]–[View stream information]**

Displays the settings of the compression method, resolution, bit rate, frame rate, etc. of the live image being displayed.



[Note:]

- Displays the value set in the stream. The actual bit rate and frame rate vary depending on your network environment and PC.

⑮ **[Main area]**

Displays the camera image.

The current date and time are displayed according to the set [Time display format] and [Date/time display format].

→8.1 [\[Basic\] to perform basic settings](#)

The set text is displayed on the screen. The number of lines is two.

When H.265 is displayed, when the bit rate is high, it may be displayed at the refresh interval.



[Note:]

- Users with low access levels may temporarily change the display but do not affect the operation of the camera.
- When the shooting scene changes significantly depending on the PC, tiring (a phenomenon in which a part of the screen is misaligned) may occur due to constraints in the OS drawing process.
- When the data encryption function is enabled, the image cannot be viewed on the live screen. Use the corresponding equipment.
- When a high zoom factor image is displayed, the clicked position may not be the center of the image.
- As the tilt angle approaches 90 degrees, the difference between the specified position and the actual direction of movement will become larger, and the specified image angle may not be achieved.
- If the mouse is dragged to move to an angle that exceeds the rotational range of the camera, the camera moves to the position where it can be operated, and then

the zoom factor is automatically adjusted.

⑩[PTZ-Panel]-[Zoom] Buttons

Adjust the zoom manually.

:Adjust the zoom factor in the [Wide angle] direction.

x1:Zoom (magnification) 1.0 times.

:Adjust the zoom factor in the [Telescope] direction.

⑪[PTZ-panel]-[Focus]

Adjust the focus manually with the buttons.

[Auto]:Automatically adjust focus.

[Near]:Adjust the focus to the [Near].

[Far]:Adjust the focus to the [Far].

[Displays the auto focus frame]:When you draw a frame with the image [On], adjust the focus (focus) to match the frame.



[Note:]

•The following subjects cannot be focused with auto focus. Focus manually.

A subject that is bright or reflects strong light

-Subject over water droplets or dirty glass

Remote and nearby subjects mixed together

-Subjects (white walls, etc.) without contrast

A horizontal subject, such as a blind-an oblique subject-a dark subject

⑫[PTZ panel]-[Control pad]

Left-click the pads and buttons to adjust the horizontal and vertical position of the image (pan tilt).

The faster the camera operates, the faster the outside of the pad is clicked.

You can also drag and adjust the mouse. Zoom and focus by right-clicking.

Clicking on the upper half of the pad in the upper and lower directions will zoom in the telephoto, and clicking on the lower half will zoom in the wide angle. Clicking on the left half in the left and right directions will bring the focus (focus) close to you, and clicking on the right half will bring it far away. You can also adjust the zoom by using the mouse wheel.

⑬[PTZ-panel]-[Auto mode]

Selecting Operation from the pull-down menu starts the selected operation.

When panning, tilting, zooming, or focusing is performed, or when the operation set in [Self return] or [Camera action on alarm] starts, it is also terminated.

→10.1 [Cam. Function] for setting the operation of cameras

→12.4 [Alarm] to set alarm linkage operation

[Automatic Tracking]:When a pre-set object to be detected is detected, the object is automatically tracked.

→10.3 Set auto-tracking (Auto-tracking screen)

[Auto Pan]:The start and end positions of the predetermined pan are automatically rotated. The pivot operation continues even after the zoom and focus operations (when the [x1] button of the [Zoom] button is clicked, the pivot operation stops).

→10.2.3 Set auto pan (Auto pan setting screen)

[Preset Sequence 1], [Preset sequence 2], [Preset sequence 3]:Move the pre-registered preset positions in order from the lowest preset number.

→10.2.2 Set the preset sequence setting (preset sequence setting screen)



[Note:]

• If the content of [Self return] operates at the time set by [Self return time] during the auto mode operation, the auto mode operation stops.

→10.1 [Cam. Function] for setting the operation of cameras

⑩[PTZ-panel]-[Preset No.]

Select the preset position from the pull-down menu and click the [Move] button to move the camera's orientation to the preset position registered beforehand.

→10.2.2 Set the preset sequence setting (preset sequence setting screen)

[H] next to the number indicates the home position. Select [HomePosition] to move the orientation of the camera to the home position.

→10.1 [Cam. Function] for setting the operation of cameras

If [Preset ID (0 - 9,A - Z)] is registered, the position name is displayed next to the number.

⑪[PTZ-panel]-[Cam. Function]

[Home position]

You can set the preset position as the home position. When the home position is set, [H] is displayed next to the preset position number.

→10.2.2 Set the preset sequence setting (preset sequence setting screen)



[Note:]

• If you want to move to the home position when the power is turned on, set [HomePosition] to [Self return].

[Self return]

When the time set by [Self return time] has elapsed after the manual operation is completed,

the camera can automatically return to the operation mode set by the camera.



[Note:]

- If you want to perform the above operations when turning on the power, it is convenient to use the self-return function.
- The self-return function works even when the setting menu is displayed.
- [Patrol] can be set only when patrols are set.
→ [10.2.4 Set patrol \(Patrol function setting screen\)](#)
- [Preset sequence] can be set only when preset sequence is set.
→ [10.2.2 Set the preset sequence setting \(preset sequence setting screen\)](#)

[Self return time]

After the manual operation is completed, select the time before returning to the operation set by [Self return].

② **[Alarm notification]**

When an alarm is generated, it is displayed as a popup. Clicking the [X] button resets the output terminal and the display disappears.

→ [2.6 Operation when alarm is generated](#)



[Note:]

- The alarm notification is not linked to the alarm notification operation such as recording to the SD Memory Card or mail transfer. Check the respective operation settings.

③ **[Camera Control Panel]–[Brightness]**

It can be adjusted from 0 to 255. **+** Clicking the button brightens the image. **–** Click the button to darken the image. **↻** Click the button to return to the default settings.

④ **[Camera Control Panel]–[Mic input volume (Camera to PC)]**

This item can be set in the following settings.

→ [3.8 \[Audio\] for setting sound](#)

• If [Audio transmission mode] is set to [Mic input] or [Interactive(Full-duplex)] [Interactive (Half-duplex)]

• If [Audio input encoding format] is set to [AAC-LC]

– Buttons, **+** Click the button or move the volume cursor to adjust the earpiece volume in four steps: Off/weak/medium/strong.

Click the Listen button to turn on/off the earpiece voice (heard on PC).



[Note:]

- When [Audio volume control mode] is set to [Adjust Mic input] in the Setup menu, the volume cursor is not displayed when using [Audio recording] or [Audio detection].
→3.8 [Audio] for setting sound
- When the computer is restarted, the earpiece volume changed by the volume cursor returns to the earpiece volume set in the [Audio] tabs of the setting menus.
→3.8 [Audio] for setting sound
- On the screen, the volume cursor can be fine-tuned, but actually it is set to one of four levels of volume.
- If you open multiple camera browsers simultaneously on the same PC, you cannot hear the sound of the camera browser opened later. Access and check one by one.
- If network communication is unstable, voice reception may be stopped. In this case, restart voice reception by turning on and off the earpiece button.

②5 [Camera Control Panel]–[Audio output volume (PC to Camera)]

This can only be set if [Audio transmission mode] is set to [Audio output] or [Interactive(Full-duplex)] [Interactive(Half-duplex)] in the configuration menus.

→3.8 [Audio] for setting sound

–Buttons, +By clicking on the buttons or by moving the volume cursors, you can adjust the volume of the call by four levels: [Off], [Low], [Middle] and [High].

Click the talk button to turn on/off the talking voice (from PC).



[Note:]

- Transmission voice can only be used when connected with HTTPS.
- If [Interactive(Half-duplex)] is set while one user is talking, the other user's listening will be stopped and the earpiece button and the talk button will not be operable. If set to [Interactive(Full-duplex)], other users will not be able to use the call key.
- The maximum call duration per call is set on the [Audio] tabs of the video and audio pages. The call stops after the set continuous call time. If you want to make another call, click the call button.
- When the computer is restarted, the earpiece volume/voice volume changed by the volume cursor will return to the earpiece volume/voice volume set in the [Audio] tab of the image/voice page.

→3.8 [\[Audio\] for setting sound](#)

- On the screen, the volume cursor can be fine-tuned, but actually it is set to one of four levels of volume.

②⑥[Camera Control Panel]-[AUX] Buttons

This setting is available only when [Terminal 3] of [Alarm] is set to [AUX output] in the Advanced menu.

→7.3.2 [Alarm: Sets terminal and operation detection \(alarm setting screen\)](#)

[Open] buttons: The AUX terminal is open.

[Close] buttons: The AUX terminal will be closed.



[Note:]

- The names of [AUX], [Open], and [Close] can be changed.
→12.3 [\[Alarm\] to change the aux name](#)

②⑦[SD Memory Cards]-[Rec. on SD]

This can only be set when [Save trigger] is set to [Manual save] on the [SD memory card] tabs. You can manually save images to SD Memory Cards by clicking [Start]. To manually save images on the SD Memory Card, refer to the following.

→2.5 [Manually save images on the SD memory card](#)

②⑧[SD Memory Cards]-[Log/Play]

Clicking [Start] displays the log list and plays back the images stored on the SD Memory Card. Please refer to the following for details of the log list and how to play back the image.

→2.7 [Display the log list](#)

②⑨[Camera to be displayed]

Select the camera to be displayed in the main area.

- [Quad]: Displays images of cameras 1, 2, 3, and 4 in quadrants.
- [Triple]: Displays images of cameras 1, 2, and 3 in triplicate.
- 1: Displays camera 1 images.
- 2: Displays camera 2 images.
- 3: Displays images of camera 3.
- 4: Displays camera 4 images.



[Note:]

- This item is not displayed when [Image capture mode] is in quad mode.

⑩[Select Streams]-[Layout] pull-down menu

This pull-down menu is displayed when [Camera to be displayed] is displayed in [Quad] [Triple] or when [Multi-directional + PTZ] is selected in [Live view].

Select the display layout of the camera image to be displayed in the main area from the following.

When [Camera to be displayed] [Quad] [Triple] is selected: [Quadruple]/ [360 deg.]/ [270 deg.]

When [View live image][Multi-directional + PTZ] is selected: [Up/Down]/[Left/Right]



[Note:]

- [MULTI_PTZ] If [Left/Right] is selected in [Layout], the displayed Multi-directional camera window will be [4 split].
- [MULTI_PTZ] If [Up/Down] is selected in [Layout], the displayed Multi-directional camera will be [360 deg.] or [270 deg.].
- [MULTI_PTZ] If the Multi-directional camera [Image capture mode] is set to [Quad Mode], [Up/Down] cannot be selected in [Layout]. If the Multi-directional camera [Image capture mode] is changed to [Quad Mode] while [Layout] is selected as [Up/Down], [Layout] is changed to [Left/Right].

⑪[Select Streams]-[Refresh Rate] pull-down menu

This pull-down menu is displayed when [Multi-directional + PTZ] is selected in [Live view]. Toggle the JPEG and stream display methods.

MJPEG:Displays a JPEG image as a series (MJPEG: Motion JPEG).

[Still image updates: 1 second]/[Refresh interval : 3s]/[Refresh interval : 5s]/[Refresh interval : 10s]/[Refresh interval : 30s]/ [Refresh interval : 60s]:Updates JPEG images (still images) at specified intervals.

[Stream]:Displays the image in stream format.



[Note:]

- [MULTI_PTZ] When selecting a stream, the image of the PTZ camera displays the stream (3) and the Multi-directional camera displays the stream (2).

⑫[PTZ-panel]-[PTZ]

The link to the PTZ camera is displayed with the name of the PTZ camera. When this name is clicked, the live picture of the PTZ camera is displayed.



[Note:]

- [MULTI_PTZ] The PTZ operation is available from the PTZ panel [PTZ] on the PTZ camera.

③ Frame rate / bit rate display button

Displays the frame rate and bit rate of the stream currently displayed in the live display.



[Note:]

- This button is not displayed if the live image meets any of the following conditions.
- JPEG stream display
 - JPEG refresh interval
 - Multi-screen
 - [Quad] display / [Triple] display
 - Multi-sensor + PTZ

2.3.3 Monitor images from multiple cameras

Images from multiple cameras can be displayed on a multi-screen. Images from 4, 9, and up to 16 cameras can be displayed simultaneously. To display images on a multi-screen, it is necessary to register cameras in advance. 4 cameras can be registered as a group and up to 4 groups (16 cameras) can be registered.

→11 [Configure the multi-screen settings](#)[Multi-screen]



[Important]

- When 16 screens are used for the display, only still images (JPEG) can be refreshed.
- [New X Fixed-8MP][New X Fixed-6MP][New X Fixed-5MP] This function is not available when [Image capture mode] is set to [60fps Mode] or [50fps Mode].



[Note:]

- When you have registered a camera with the authentication function enabled, it is necessary to access the camera and register the user name of “Administrator” and password in the web browser in advance.
Refer to our technical information website <Control No.: C0302> for information about the terms and conditions for use of multi-screen.

From the [Live view] pull-down menu in the [Live] page, select [Multi-screen]. Images from the registered cameras will be displayed on a selected multi-screen (screen can be split up to 16

areas). The following are instructions when displaying on a 4-split screen.

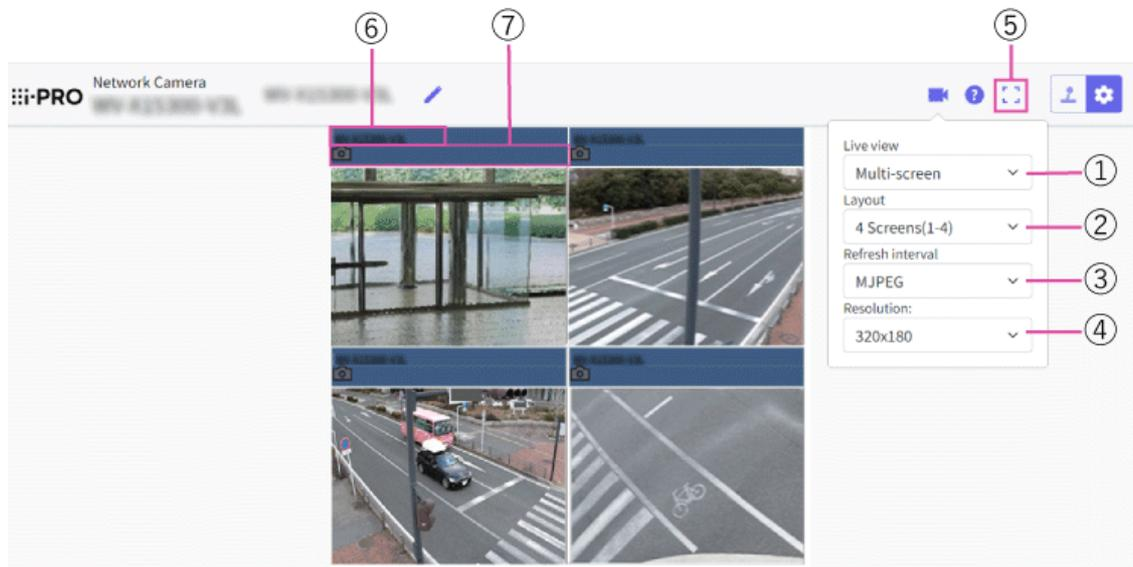

- ① **[Live view] pull-down menu**
Select the image displayed in the main area.
- ② **[Layout] pull-down menu**
Select from the pull-down menu to display images from cameras in multi-screens of 4 to 9 or even 16screens.
- ③ **[Refresh interval] pull-down menu**
Select from the pull-down menu and switch between video (MJPEG) and still images (JPEG).For still images (JPEG), select the refresh interval (Refresh interval : 1s/Refresh interval : 3s/Refreshinterval : 5s/Refresh interval : 10s/Refresh interval : 30s/Refresh interval : 60s) for camera images.
When the 16 screen layout is used, Refresh interval : 1s cannot be selected.
- ④ **[Image capture size] pull-down menu**
Select the image capture size from the pull-down menu to change it.When you select [4 Screens] in the [Layout] pull-down menu, the image capture size of the camerachanges.
- ⑤ **Full screen display**
If you press the full screen button, the display of the camera image will be maximized. If you click the[x] button in the full screen display, the display size will be reset to original size.
- ⑥ **Camera title**
If you click the camera title, live images from the corresponding camera will be displayed on the“Live” page of the newly opened window.
- ⑦ **Camera control bar**
Can be used to get snap shot of JPEG images.



[Note:]

- The frame rate may drop depending on the network environment and number of accessing users.
- If the image capture size specified for JPEG cannot be obtained, a JPEG image with an image capture size that could be obtained is displayed. Therefore, when JPEG images obtained with snapshot are displayed on a PC, the displayed image size may differ from the captured sized.

2.4 Viewing images from mobile/tablet terminals

2.4.1 Viewing images from mobile devices (smartphones, etc.)

Connect a portable terminal to your computer and display images (MJPEG and JPEG formats) of your computer. The latest image is automatically updated.

The following models are supported. As of April 2022

-iPad, iPhone (iOS 8 or later)

-Android™ terminal



[Important]

- If the Authentication dialog appears, enter your username and password.
→ [13.1 \[User auth.\] to configure user-authentication](#)



[Note:]

- In order to view images of your computer from a mobile terminal, it is necessary to set up a network to connect to the Internet in advance.
→ [14 Networking configuration \[Network\]](#)
- [New X Fixed-8MP][New X Fixed-6MP][New X Fixed-5MP]Images cannot be displayed when [Image capture mode] is set to [60fps Mode] or [50fps Mode].

2.4.1.1 Viewing images of Fixed cameras from a portable terminal (smartphone, etc.)

- 1 [\[http://IP address/cam\]](#) by mobile phone*¹Or [\[Host name/cam registered at http://DDNS server\]](#)*²Enter and press the Enter button to view the this product image.

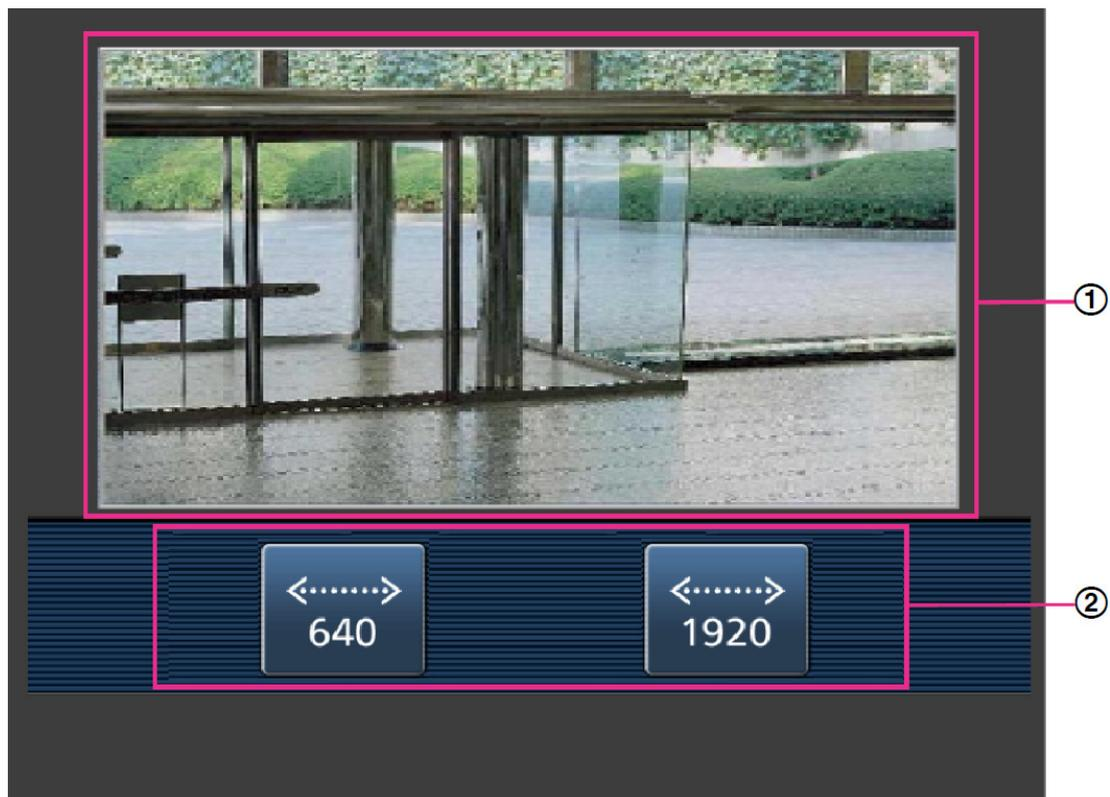

①[Live image]

Displays the area camera image.

②[Operation button area]

When the function is selected in the function selection area, the button to operate the function is displayed.



[Note:]

•The operation buttons displayed on the screen of the mobile terminal may not be displayed depending on the user privileges and function permission settings of the user to access. If you want to view the operations buttons, you need to set the user privileges and function permissions ([User mng.] [User auth.]).

→[13.1 \[User auth.\] to configure user-authentication](#)

2 Click the button of the function you want to operate.

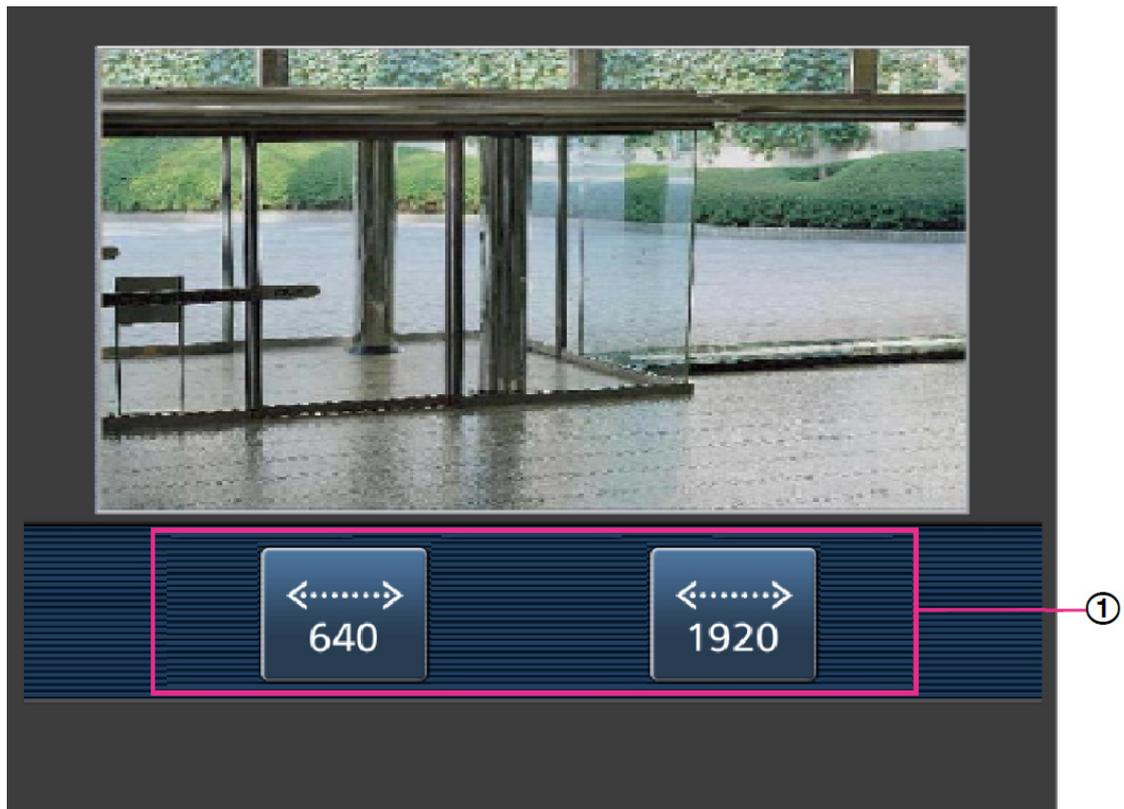

① [Image capture size switchover]

 When the button is pressed, the button for selecting Image capture size is displayed.

Select Image capture size from the displayed buttons to toggle Image capture size.

The Image capture size set in the [JPEG(1)] [JPEG(2)] of the [JPEG] in the [Image] tab is displayed.



[Note:]

- Images with a Image capture size of "3840x2160", "3328x1872", "3072x2304", "3072x1728", "2688x1520", "2560x1920", or "2560x1440" cannot be displayed.



[Note:]

- The screen size displayed on the mobile phone can be changed by accessing the following.

-Large screen size: <http://IP address/cam/dl>

-Display medium: <http://IP address/cam/dm>

-display small: <http://IP address/cam/ds>

- The Image capture size displayed by performing [Resolution] changes, but the size of the images does not change.

- If the HTTP port number is changed from 80, [http://IP address:port number/cam]^{*1}Enter the port number of the this product. If you are using the DDNS function, [http://Host name registered on the DDNS server: Port number/cam]^{*2}Please enter.
 - If you are configuring [HTTPS] in [HTTPS]-[Connection] on the [Advanced] tab of the Network Page, enter the following.
Https://IP address: port number/cam or the host name registered with the https://DDNS server: port number/cam
 - When the Authentication dialog appears, enter the administrator's or general user's username and password. Depending on the mobile phone, the password may need to be entered each time the screen is switched.
 - Audio cannot be received or sent from a mobile terminal.
 - Some mobile terminals may not be able to display images when the image size is large. This may be displayed when the [Image quality setting] of [JPEG] is close to low quality.
- 9.2 [Image] for setting JPEG images

| |
|-------------------------------------------------------------------------------------------------------------------------------------------------------------------------------------------------------------------------------------------------------------------------------------------------------------------|
| <p>*1 The IP address is the global IP address on the WAN side of the router that can be accessed from the Internet. However, it is the local IP address when accessing the this product in the same LAN with a wireless connected mobile terminal.</p> <p>*2 Only accesses this product via the Internet.</p> |
|-------------------------------------------------------------------------------------------------------------------------------------------------------------------------------------------------------------------------------------------------------------------------------------------------------------------|

2.4.1.2 Viewing PTZ camera images from a mobile terminal (smartphone, etc.)

- 1 [http://IP address/cam] by mobile phone^{*1}Or [Host name/cam registered at http://DDNS server]^{*2}Enter the data and press the Enter button to display the image of the computer.

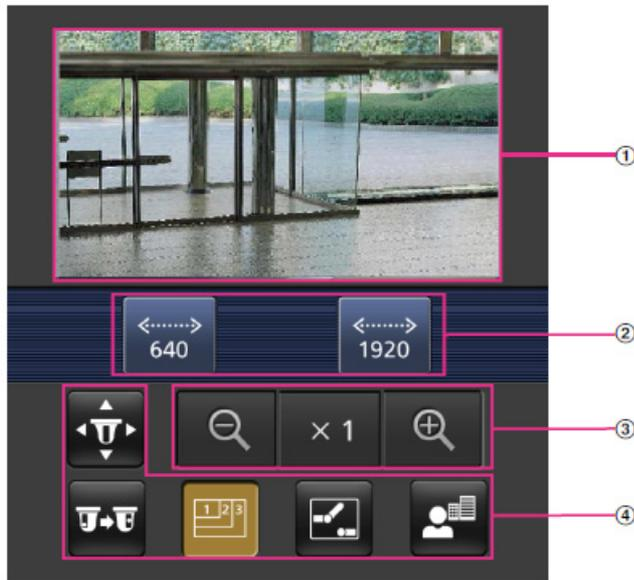

①[Live image]

Displays the area camera image.

②[Operation button area]

When the function is selected in the function selection area, the button to operate the function is displayed.

③[Zoom operation area]

Displays the zoom button.

④[Function selection area]

Displays and selects functions that can be operated, and the operation buttons are displayed in the operation button area.



[Note:]

•The operation buttons displayed on the screen of the mobile terminal may not be displayed depending on the user privileges and function permission settings of the user to access. If you want to view the operations buttons, you need to set the user privileges and function permissions ([User mng.] [User auth.]).

→[13.1 \[User auth.\] to configure user-authentication](#)

2 Click the button of the function you want to operate.

2 Operation

2.4 Viewing images from mobile/tablet terminals

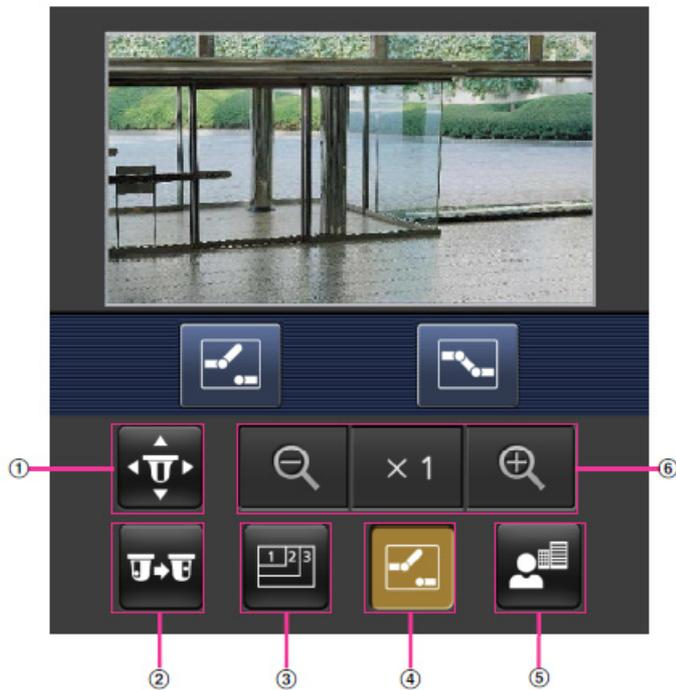

①[Pan/Tilt]

 Press the button to display the button to operate the pan/tilt. , , ,  Press the buttons to pan/tilt in each direction.

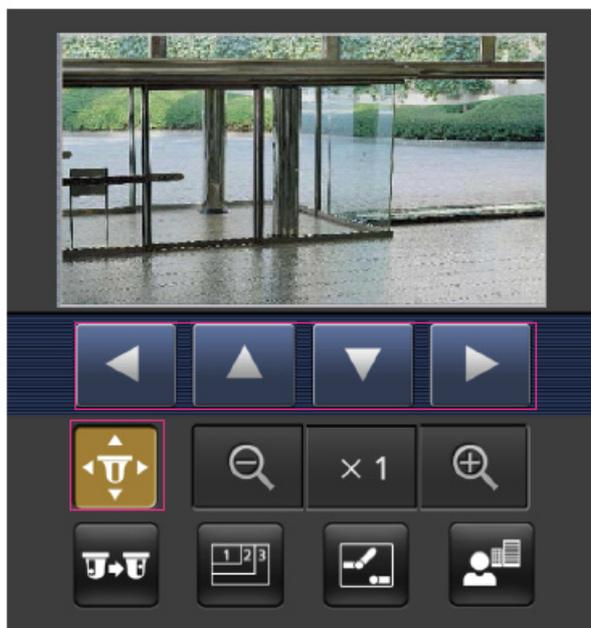

②[Preset]

 Press the button to display the button for selecting the preset position. By selecting the preset number from the displayed button, the camera image is displayed in the direction of the

2 Operation

2.4 Viewing images from mobile/tablet terminals

preset registered camera.

Only position numbers 1 to 4 are displayed for preset positions.

Only registered preset positions are displayed, and unregistered preset positions are not displayed.

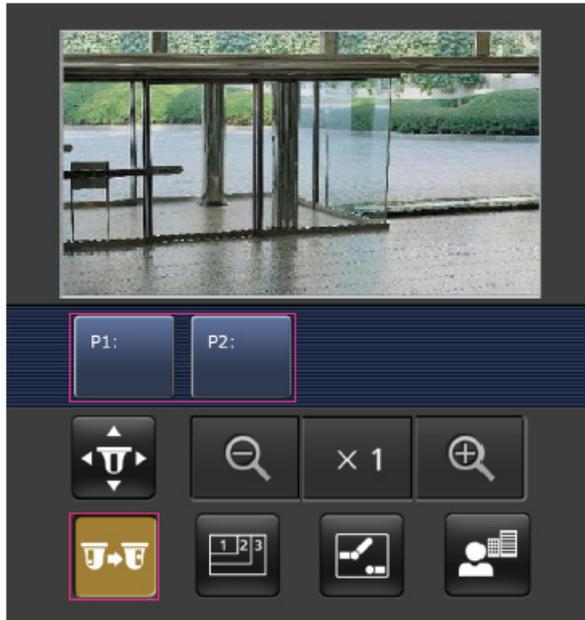

③ [Resolution switchover]

 Press the button to display the screen for selecting the resolution.

The resolution is switched by selecting the resolution from the displayed buttons.

The resolution set in the [JPEG(1)] [JPEG(2)] of the [JPEG] in the [Image] tab is displayed.



④ [Aux control]

2 Operation

2.4 Viewing images from mobile/tablet terminals

Press the button to display the button to operate the AUX output.

、 The button enables you to control the AUX output terminal.

This message is displayed only when [Terminal 3] is set to [AUX output] in the operation setting menu.

→12.1 [\[Alarm\] to set alarm operation](#)

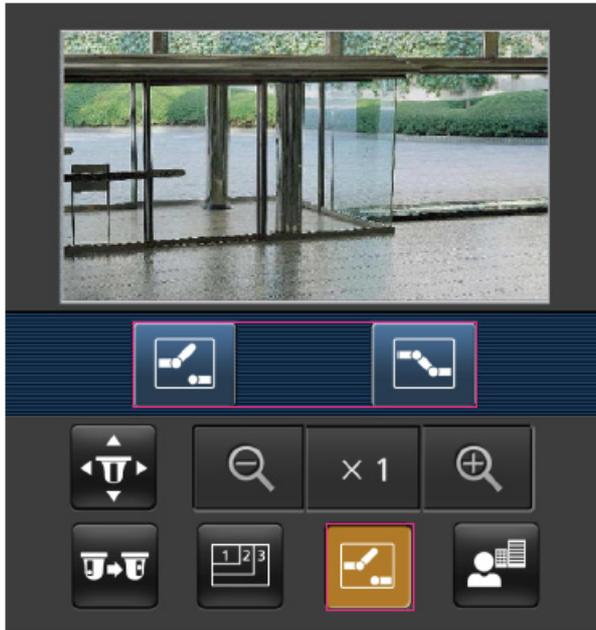

⑤ [Focus Display]

Press the button to display the button to perform the focus operation.

、、 The button allows focusing of the camera image.

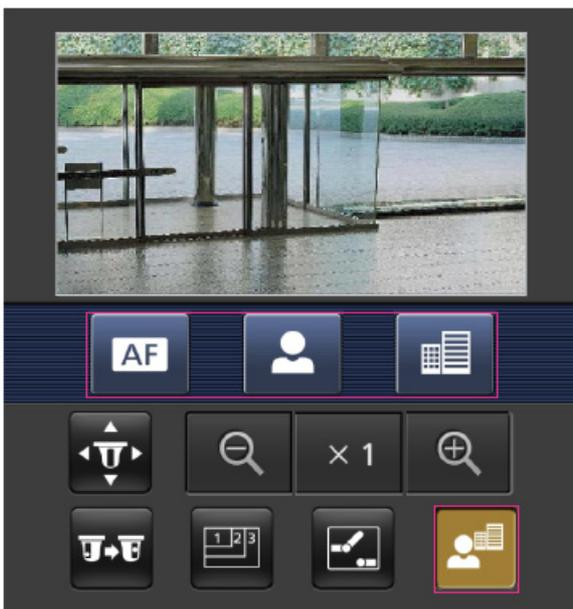

⑥[Zoom display]

、、 You can zoom the camera image with the buttons.



[Note:]

- The screen size displayed on the mobile phone can be changed by accessing the following.
 - Large screen size: <http://IP address/cam/dl>
 - Display medium: <http://IP address/cam/dm>
 - display small: <http://IP address/cam/ds>
- The resolution displayed by [Resolution] changes, but the size of the images does not change.
- If the HTTP port number is changed from 80, [<http://IP address:port number/cam>]^{*1}Enter the port number of the machine. If you are using the DDNS function, [<http://Host name registered on the DDNS server: Port number/cam>]^{*2} Please enter.
- If you are configuring [HTTPS] in [HTTPS]-[Connection] on the [Advanced] tab of the Network Page, enter the following.
 - [Https://IP address: port number/cam](https://IP address: port number/cam) or the host name registered with the <https://DDNS server: port number/cam>
- When the Authentication dialog appears, enter the administrator's or general user's username and password. Depending on the mobile phone, the password may need to be entered each time the screen is switched.
- Audio cannot be received or sent from a mobile terminal.
- Some mobile terminals may not be able to display images when the image size is

large. This may be displayed when the [Image quality setting] of [JPEG] is close to low quality.

→9.2 [Image] for setting JPEG images

*1 The IP address is the global IP address on the WAN side of the router that can be accessed from the Internet.

Note, however, that this is the local IP address when accessing the handset in the same LAN with a mobile terminal supporting wireless connection.

*2 Only for accessing the computer via the Internet.

2.4.1.3 Viewing images of a Multi-directional camera from a portable terminal (smartphone, etc.)

- 1 [http://IP address/cam] by mobile phone*¹Or [Host name/cam registered at http://DDNS server]*²Enter the data and press the Enter button to display the image of the computer.

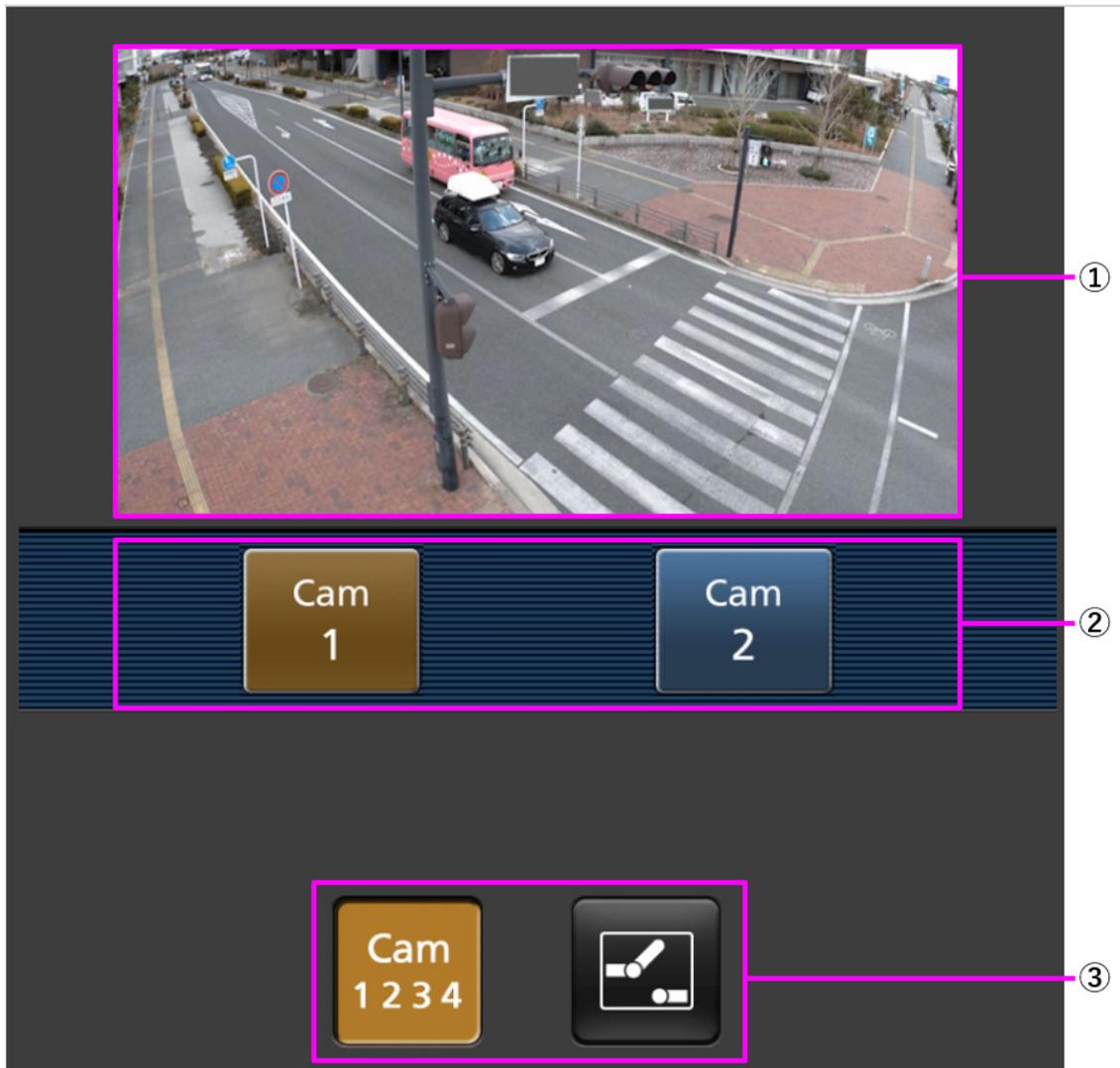

①[Live image]

Displays the area camera image.

②[Operation button area]

When the function is selected in the function selection area, the button to operate the function is displayed.

③[Function selection area]

Displays and selects functions that can be operated, and the operation buttons are displayed in the operation button area.



[Note:]

• The operation buttons displayed on the screen of the mobile terminal may not be displayed depending on the user privileges and function permission settings of the user to access. If you want to view the operations buttons, you need to set the

2 Operation

2.4 Viewing images from mobile/tablet terminals

user privileges and function permissions ([User mng.] [User auth.]).

→13.1 [User auth.] to configure user-authentication

- 2 Click the button of the function you want to operate.



①[Camera switchover]

When the button is pressed, the button to select the camera is displayed on the screen.

Select the camera from the displayed button to change the displayed camera.

Images of Cameras 1 and 2 are displayed in the Image capture size set in [JPEG] in the [Image] tab.

2 Operation

2.4 Viewing images from mobile/tablet terminals



②[Aux control]

 Press the button to display the button to operate the AUX output.

  The button enables you to control the AUX output terminal.

This message is displayed only when [Terminal 3] is set to [AUX output] in the operation setting menu.

→ [12.1 \[Alarm\] to set alarm operation](#)



[Note:]

- If the HTTP port number is changed from 80, [http://IP address:port number/cam]^{*1}Enter the port number of the machine. If you are using the DDNS function, [http://Host name registered on the DDNS server: Port number/cam]^{*2} Please enter.
- If you are configuring [HTTPS] in [HTTPS]-[Connection] on the [Advanced] tab of the Network Page, enter the following.
Https://IP address: port number/cam or the host name registered with the https://DDNS server: port number/cam
- When the Authentication dialog appears, enter the administrator's or general user's username and password. Depending on the mobile phone, the password

2 Operation

2.4 Viewing images from mobile/tablet terminals

may need to be entered each time the screen is switched.

- Audio cannot be received from a portable terminal.
- Some mobile terminals may not be able to display images when the image size is large. This may be displayed when the [Image quality setting] of [JPEG] is close to low quality.

*1 The IP address is the global IP address on the WAN side of the router that can be accessed from the Internet. Note, however, that this is the local IP address when accessing the handset in the same LAN with a mobile terminal supporting wireless connection.

*2 Only for accessing the computer via the Internet.

2.4.1.4 Viewing images of a Multi-directional/PTZ camera from a portable terminal (smartphone, etc.)

PTZ camera

- 1 [http://IP address/cam] by mobile phone*1Or [Host name/cam registered at http://DDNS server]*2Enter the data and press the Enter button to display the image of the computer.

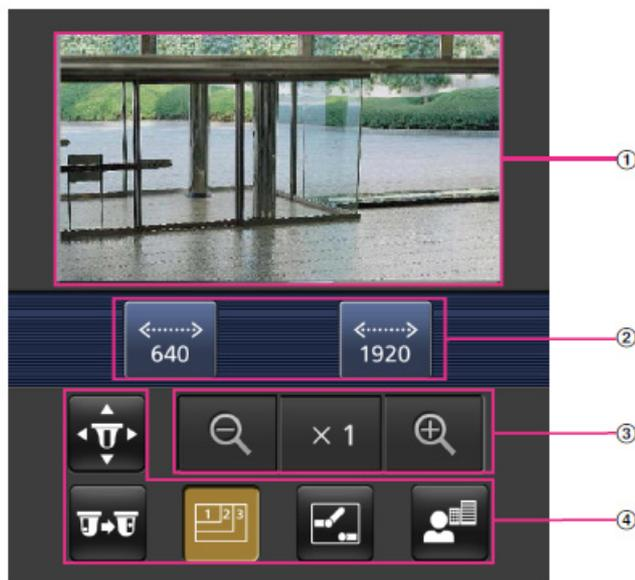

①[Live image]

Displays the area camera image.

②[Operation button area]

When the function is selected in the function selection area, the button to operate the function is displayed.

③ [Zoom operation area]

Displays the zoom button.

④ [Function selection area]

Displays and selects functions that can be operated, and the operation buttons are displayed in the operation button area.



[Note:]

• The operation buttons displayed on the screen of the mobile terminal may not be displayed depending on the user privileges and function permission settings of the user to access. If you want to view the operations buttons, you need to set the user privileges and function permissions ([User mng.] [User auth.]).

→ [13.1 \[User auth.\] to configure user-authentication](#)

2 Click the button of the function you want to operate.

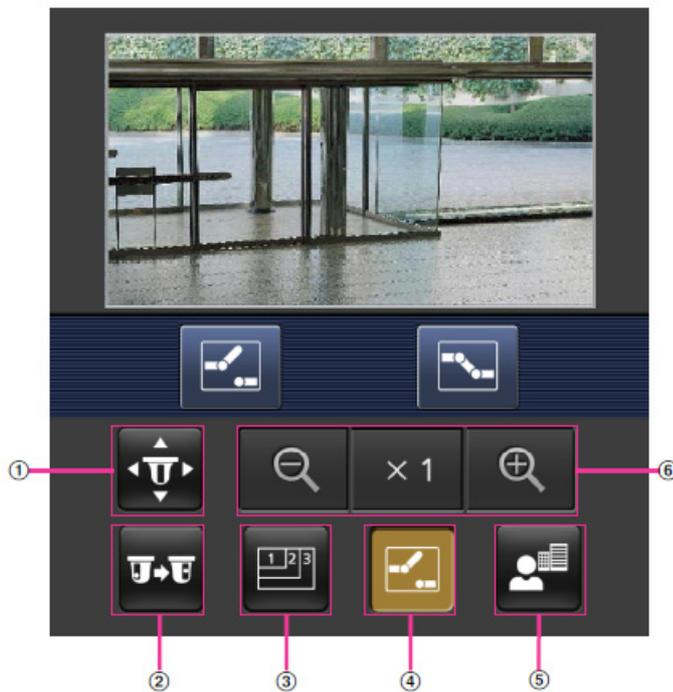

① [Pan/Tilt]

Press the button to display the button to operate the pan/tilt. 、、、 Press the buttons to pan/tilt in each direction.

2 Operation

2.4 Viewing images from mobile/tablet terminals

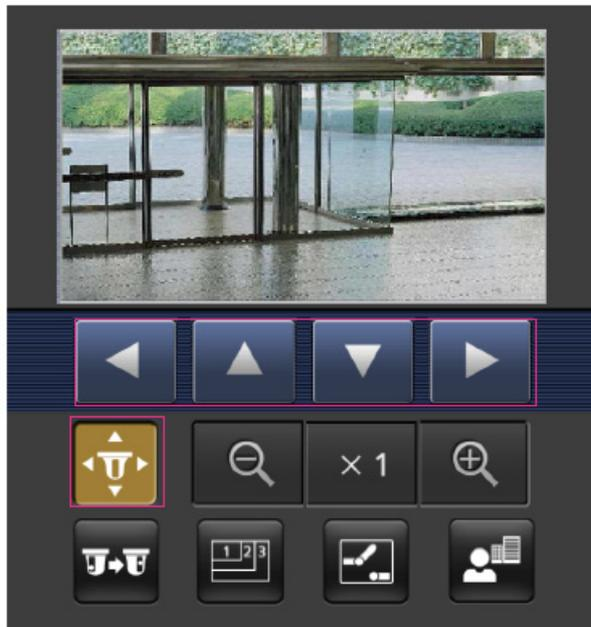

②[Preset]

 Press the button to display the button for selecting the preset position. By selecting the preset number from the displayed button, the camera image is displayed in the direction of the preset registered camera.

Only position numbers 1 to 4 are displayed for preset positions.

Only registered preset positions are displayed, and unregistered preset positions are not displayed.



③[Resolution switchover]

2 Operation

2.4 Viewing images from mobile/tablet terminals

 Press the button to display the screen for selecting the resolution.

The resolution is switched by selecting the resolution from the displayed buttons.

The resolution set in the [JPEG(1)] [JPEG(2)] of the [JPEG] in the [Image] tab is displayed.



④[Aux control]

 Press the button to display the button to operate the AUX output.

、 The button enables you to control the AUX output terminal.

This message is displayed only when [Terminal 3] is set to [AUX output] in the operation setting menu.

→12.1 [\[Alarm\] to set alarm operation](#)

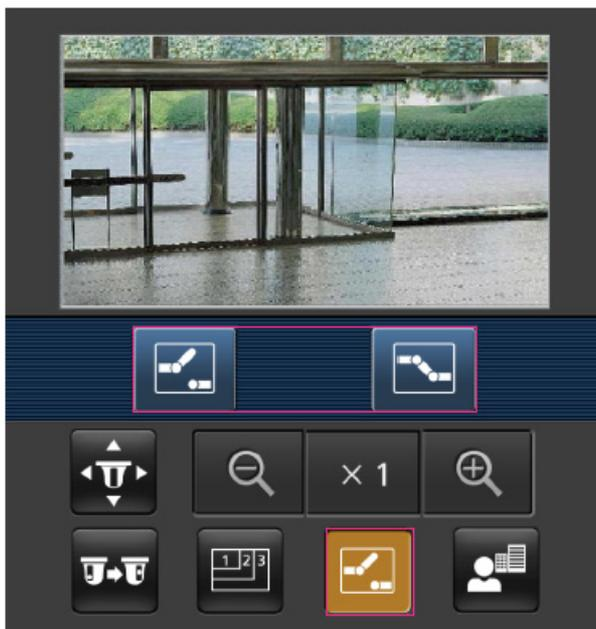

⑤ [Focus Display]

 Press the button to display the button to perform the focus operation.

、、 The button allows focusing of the camera image.

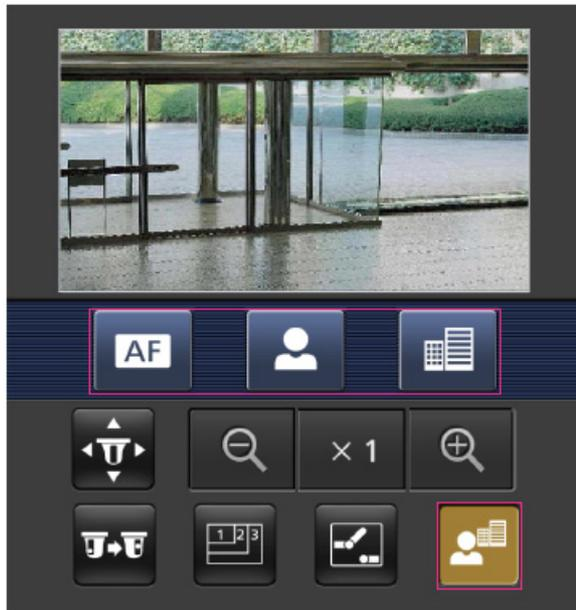

⑥ [Zoom display]

、、 You can zoom the camera image with the buttons.

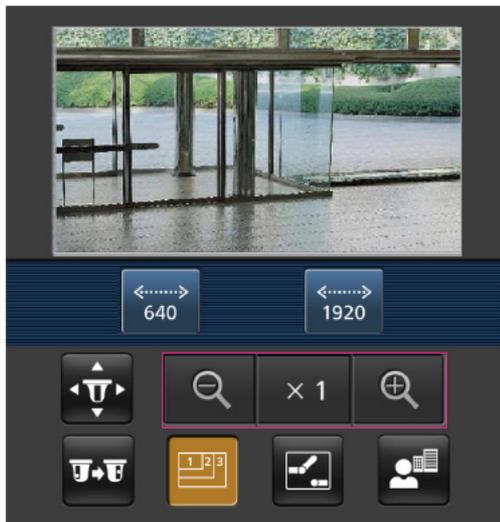

[Note:]

• The screen size displayed on the mobile phone can be changed by accessing the following.

-Large screen size: <http://IP address/cam/dl>

-Display medium: <http://IP address/cam/dm>

-display small: http://IP address/cam/ds

- The resolution displayed by [Resolution] changes, but the size of the images does not change.
 - If the HTTP port number is changed from 80, [http://IP address:port number/cam]*¹Enter the port number of the machine. If you are using the DDNS function, [http://Host name registered on the DDNS server: Port number/cam]*² Please enter.
 - If you are configuring [HTTPS] in [HTTPS]-[Connection] on the [Advanced] tab of the Network Page, enter the following.
Https://IP address: port number/cam or the host name registered with the https://DDNS server: port number/cam
 - When the Authentication dialog appears, enter the administrator's or general user's username and password. Depending on the mobile phone, the password may need to be entered each time the screen is switched.
 - Audio cannot be received or sent from a mobile terminal.
 - Some mobile terminals may not be able to display images when the image size is large. This may be displayed when the [Image quality setting] of [JPEG] is close to low quality.
- 9.2 [\[Image\] for setting JPEG images](#)

*1 The IP address is the global IP address on the WAN side of the router that can be accessed from the Internet.
Note, however, that this is the local IP address when accessing the handset in the same LAN with a mobile terminal supporting wireless connection.

*2 Only for accessing the computer via the Internet.

Multi-directional camera

- 1 [http://IP address/cam] by mobile phone*¹Or [Host name/cam registered at http://DDNS server]*²Enter the data and press the Enter button to display the image of the computer.



①[Live image]

Displays the area camera image.

②[Camera switchingArea]

The button for selecting the camera to be displayed in the live image is displayed.

Select the camera from the displayed button to change the displayed camera.

Images of cameras 1, 2, 3 and 4 are displayed at the resolution set in [JPEG] in the [Image] tabs.



[Note:]

- The operation buttons displayed on the screen of the mobile terminal may not be displayed depending on the user privileges and function permission settings of the user to access. If you want to view the operations buttons, you need to set the user privileges and function permissions ([User mng.] [User auth.]).

→13.1 [User auth.] to configure user-authentication

- If the HTTP port number is changed from 80, [http://IP address:port number/cam]*¹Enter the port number of the machine. If you are using the DDNS function, [http://Host name registered on the DDNS server: Port number/cam]*²Please enter.

- If you are configuring [HTTPS] in [HTTPS]-[Connection] on the [Advanced] tab of the Network Page, enter the following.

Https://IP address: port number/cam or the host name registered with the https://DDNS server: port number/cam

- When the Authentication dialog appears, enter the administrator's or general user's username and password. Depending on the mobile phone, the password may need to be entered each time the screen is switched.

- Some mobile terminals may not be able to display images when the image size is large. This may be displayed when the [Image quality setting] of [JPEG] is close to low quality.

*1 The IP address is the global IP address on the WAN side of the router that can be accessed from the Internet. Note, however, that this is the local IP address when accessing the handset in the same LAN with a mobile terminal supporting wireless connection.

*2 Only for accessing the computer via the Internet.

2.4.2 View images from a tablet terminal

Connect the tablet terminal to the computer and display images (MJPEG and JPEG formats) of the computer. The latest image is automatically updated. The following models are supported. As of April 2022

-iPad, iPhone (iOS 8 or later)

-Android terminal



[Important]

- If the Authentication dialog appears, enter your username and password.
→13.1 [User auth.] to configure user-authentication



[Note:]

- To view images on your computer from a tablet terminal, it is necessary to set up a network to connect to the Internet in advance.
→14 Networking configuration [Network]
- Depending on the model, the same screen as the PC may be displayed. In this case, enter either [http://IP address/live/tab.html] or [http://DDNS server/live/tab.html] to connect.
- [New X Fixed]Images cannot be displayed when [Image capture mode] is set to [60fps Mode] or [50fps Mode].

2.4.2.1 Viewing images of Fixed cameras from a tablet terminal

- 1 [http://IP address] on the tablet terminal*1Or [host name/ registered in the http://DDNS server]*2When typing and connecting to this product, the this product images are displayed.

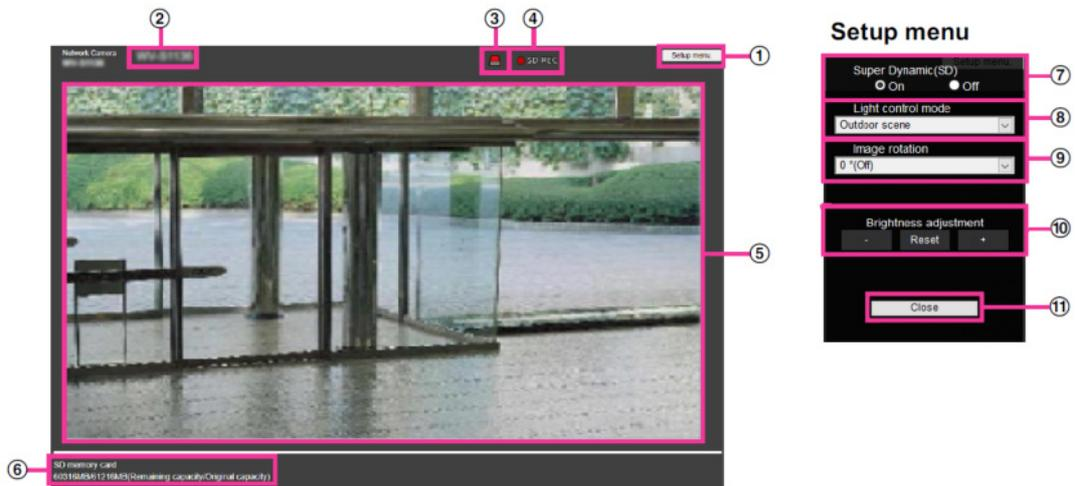

①[Setup menu.] buttons*3

Indicates the setup menu.

②[Camera title]

The title of the camera entered in [Camera title] on the [Basic] tab is displayed.

→3.2 [Basic] to perform basic settings

③[Alarm Notification button]*4

The lamp blinks when an alarm is generated. Click the button to disappear.



[Note:]

• The alarm notification button blinks in conjunction with the alarm notification operation such as mail transfer. Check the operation setting.

④[SD Storage Status Display]

Displays the storage status on the SD Memory Card. When saving starts, the SD save status indicator turns red. The LED turns OFF when saving stops.

This is displayed when the [Save trigger] in the Setup menu is set to [Manual save] or [Schedule].

→8.2 [SD memory card] for setting SD Memory Cards

⑤[Main area]

Live displays the camera image.

⑥[Capacity display]

The remaining capacity and total capacity of the SD Memory Card are displayed.

⑦[Super dynamic setting]

You can set [On] or [Off] to activate the super dynamic function. You can set for each preset position. This cannot be set when [Image capture mode] is in [60 fps mode] or [50 fps mode].

See [What is Super Dynamic] for details on super dynamic.

[On]:The Super Dynamic function is activated.

[Off]:Stops the superdynamic function.



[Note:]

- Set [Super Dynamic] to [Off] when the following phenomena are observed depending on the lighting condition.
 - when flickering or color changes occur
 - when noise is generated in the bright area of the screen
- When [Stabilizer] is set to [On], the superdynamic setting is [Off].

⑧[Light control mode] pull-down menu

Select the mode to control the light intensity from the following.

[Flickless (50 Hz)]/[Flickless (60 Hz)]:Flicker is automatically corrected with a fluorescent lamp. 50 Hz/60 Hz will be used differently in different regions.

[ELC]:The electronic shutter is used to control the light intensity.



[Note:]

- When [Image capture mode] is 25fps, [Indoor scene(60Hz)] cannot be set.

⑨[Image Rotation]

Set whether to rotate the image (JPEG, H.265 or H.264).

0° (Off):The image is not rotated.

90° :Rotate the image 90 degrees.

180 degrees (vertical inversion):The image is inverted up and down.

270° :Rotate the image 270 degrees.



[Important]

- If the image rotation setting is changed with the following area set, the position will be misaligned. Therefore, set each area after setting image rotation.
 - Privacy Zone
 - Operation detection area
 - Undesired detection area
 - VIQS area
 - Mask area
 - overlay image
 - Focus frame

- If you set [Image Rotation] to [90°] or [270°], the character on the screen may be broken depending on the [Character Size] setting and the number of characters.
- When [Rotate images] is set to [90°] and [270°], the positions that can be set to [Date/time position] and [Camera title position] are limited to [upper left] and [lower left].



[Note:]

- If [Image capture size] is 320 x 180, [Image rotation] cannot be set to 90° or 270° .
- [New X Fixed] Even when [Image capture size] is set to 320x180, you can set [Image rotation] to 90° or 270° .

⑩[Brightness adjustment] buttons

Adjust the brightness.

Press the [Light (+)] button to brighten the image.

Press the [Dark (-)] button to darken the image.

Press [Reset] to return to the default brightness.

⑪[Close] buttons

Hides the Setup menu.



[Note:]

- If the HTTP port number is changed from 80, [http://IP address:port number/]*¹
Enter the port number of the this product. If the DDNS function is used,
[http://Host name registered on the DDNS server: Port number/]*³Please enter.
- If you are configuring [HTTPS] in [HTTPS]-[Connection] on the [Advanced] tab of the Network Page, enter the following.
[https://IP address:port number/] or [host name registered on the https://
DDNS server: port number/]
- When the Authentication dialog appears, enter the administrator's or general user's username and password. Depending on the mobile phone, the password may need to be entered each time the screen is switched.
- Depending on the tablet terminal, the image may not be displayed when the size of the image is large. This may be displayed when the [Image quality setting] of [JPEG] is close to low quality.
→9.2 [Image] for setting JPEG images
- You may not be able to access some tablets and contract plans.

2 Operation

2.4 Viewing images from mobile/tablet terminals

- *1 The IP address is the global IP address on the WAN side of the router that can be accessed from the Internet.
However, it is the local IP address when accessing the this product in the same LAN with a wireless connected mobile terminal.
- *2 Only accesses this product via the Internet.
- *3 It is available only for users whose access levels are set to [1. Administrator].
- *4 When [User auth.] is set to [On], only users with access levels set to [1. Administrator] or [2. Camera control] can work.
→[13.1 \[User auth.\] to configure user-authentication](#)

2.4.2.2 View PTZ camera images from a tablet terminal

- 1 [http://IP address] on the tablet terminal*¹Or [host name/ registered in the http://DDNS server]*²The image of the computer is displayed when you enter it and connect it to the computer.

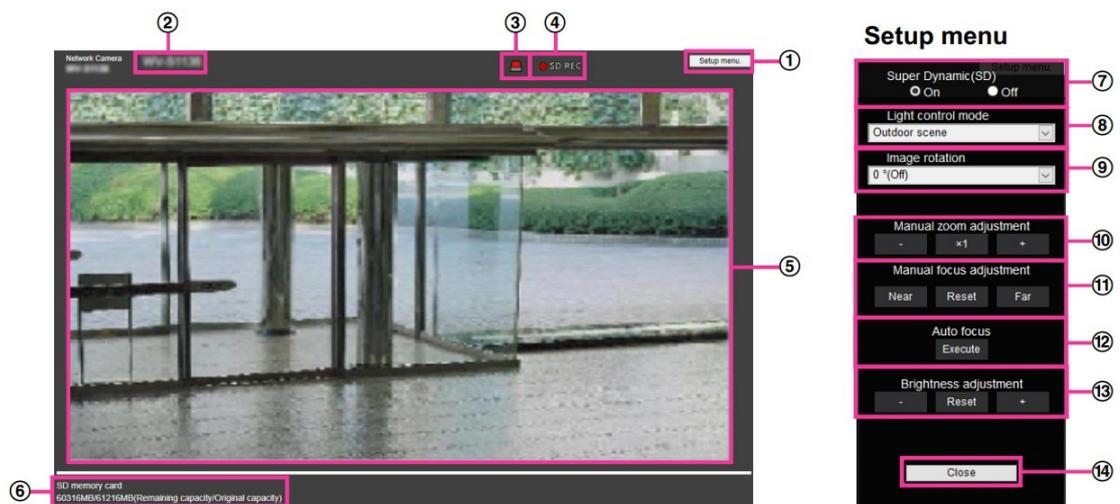

①[Setup menu.] buttons*3

Indicates the setup menu.

②[Camera title]

The title of the camera entered in [Camera title] on the [Basic] tab is displayed.

→[3.2 \[Basic\] to perform basic settings](#)

③[Alarm Notification button]*4

The lamp blinks when an alarm is generated. Click the button to disappear.



[Note:]

- The alarm notification button blinks in conjunction with the alarm notification operation such as mail transfer. Check the operation setting.

④[SD Storage Status Display]

Displays the storage status on the SD Memory Card. When saving starts, the SD save status indicator turns red. The LED turns OFF when saving stops.

This is displayed when the [Save trigger] in the Setup menu is set to [Manual] or [Schedule].

→8.2 [SD memory card] for setting SD Memory Cards

⑤[Main area]

Live displays the camera image.

⑥[Capacity display]

The remaining capacity and total capacity of the SD Memory Card are displayed.

⑦[Super dynamic setting]

You can set [On] or [Off] to activate the super dynamic function. You can set for each preset position. This cannot be set when [Image capture mode] is in [60 fps mode] or [50 fps mode]. See [What is Super Dynamic] for details on super dynamic.

[On]:The Super Dynamic function is activated.

[Off]:Stops the superdynamic function.



[Note:]

- Set [Super Dynamic] to [Off] when the following phenomena are observed depending on the lighting condition.
 - when flickering or color changes occur
 - when noise is generated in the bright area of the screen
- If [Light control mode] is set to [Fix shutter], [Super Dynamic] cannot be set to [On].
- When [Stabilizer] is set to [On], the superdynamic setting is [Off].

⑧[Light control mode] pull-down menu

Select the mode to control the light intensity from the following.

[Outdoor shooting]:The brightness (illumination) controls the light intensity by combining the electronic shutter and automatic aperture. This setting is used when shooting bright subjects such as outdoors. Be careful not to flicker under fluorescent lights, etc.

[Flickless (50 Hz)]/[Flickless (60 Hz)]:Flicker is automatically corrected with a fluorescent lamp. 50 Hz/60 Hz will be used differently in different regions.

[Fixed shutter]:

If [Image capture mode] is in 30 fps or 15 fps mode:

[1/30 fixed], [3/120 fixed], [2/100 fixed], [2/120 fixed], [1/100 fixed], [1/120 fixed], [1/250 fixed], [1/500 fixed], [1/1000 fixed], [1/2000 fixed], [1/4000 fixed], or [1/10000 fixed]

If [Image capture mode] is in 25 fps or 12.5 fps mode:

[1/25 fixed]/[3/100 fixed]/[2/100 fixed]/[1/100 fixed]/[1/250 fixed]/[1/500 fixed]/[1/1000 fixed]/[1/2000 fixed]/[1/4000 fixed]/[1/10000 fixed]

When [Image capture mode] is 60 fps:

[1/60 fixed]/[1/100 fixed]/[1/120 fixed]/[1/250 fixed]/[1/500 fixed]/[1/1000 fixed]/[1/2000 fixed]/[1/4000 fixed]/[1/10000 fixed]

If [Image capture mode] is in 50fps mode:

[1/50 fixed]/[1/100 fixed]/[1/250 fixed]/[1/500 fixed]/[1/1000 fixed]/[1/2000 fixed]/[1/4000 fixed]/[1/10000 fixed]



[Note:]

- If you increase the shutter speed ($\sim 1/10,000$), you will be less prone to blur even when the subject moves faster.
- Increasing the shutter speed decreases the sensitivity.
- If [Super Dynamic] is set to [On], [Fix shutter] cannot be set. To configure [Fix shutter], set [Super Dynamic] to [Off].
- [Indoor scene(60Hz)] cannot be set when [Image capture mode] is in 25fps, 50fps, or 12.5fps modes.

⑨ **[Preset position setting]**

Set the preset position.

Before registering the preset, move the camera in the direction you want to register.

To change the orientation of the camera, enable [Swipe operation permission] and select the image position to be centered on the image angle. The camera's orientation moves to a position centered on the clicked position.

If you want to zoom in, enable [Swipe operation permission] and select the zoom area in the picture.



[Important]

- When registering a preset position using a tablet, pay attention to the following.
 - If updating of the image on the tablet is slow, it is recommended that you register the preset while viewing the image on the confirmation monitor.
 - If you resize the screen with tablet operation, you may not be able to change the

orientation or zoom in on the screen.

-If the orientation of the camera cannot be adjusted by tablet operation, refer to the following to move the camera orientation in the direction you want to register.

→2.4.1 [Viewing images from mobile devices \(smartphones, etc.\)](#)

Preset

Set the position number to be registered.

Position name indication

Use [On] and [Off] to set whether the position name is displayed. You can set for each preset position.

[On]:Displays the position name.

[Off]:The position name is not displayed.



[Important]

•If you set [Preset ID], be sure to press [Register].



[Note:]

•When set to [On], the position name is displayed where you set the position in [Camera title position] on the [Basic] tab.

Position name

Enter the name to be displayed on the image. You can set for each preset position.

Number of characters that can be entered:0 to 40 characters

Input Characters:0-9 (single-byte), A-Z (single-byte, uppercase, lowercase), double-byte, single-byte symbol ! " # \$ % & ' () * + , - . / : ; = ?



[Important]

• If you set [Preset ID (0 – 9,A – Z)], be sure to press [Register].



[Note:]

•The position name entered is displayed next to the preset position number in the pull-down. If [Preset ID] is set to [On], it can also be displayed on the images.

⑩[Auto focus]

Use [Auto] and [Off] to set whether auto focus is performed after the preset is moved. You can set for each preset position.

[Auto]:Auto focus is performed after the preset is moved.

[Off]:Auto focus is not performed after moving the preset.



[Note:]

- When presetting a subject whose depth does not change, a subject whose contrast is low, or a subject with high brightness such as a spotlight, etc., set [Off] and register the preset position after setting the focus.

Stopping time

During the preset sequence operation, select the time to reflect the image of each preset position (the time when the camera stops rotating) from the following.

[5s]/ [10s]/ [15s]/ [20s]/ [25s]/ [30s]



[Note:]

- The preset position set to [Off] does not move to that position during the preset sequence, but instead moves to the next preset position.
- Depending on the stop time setting, the watch may move to the next preset position during auto focus operation.
- If the preset sequence function is used for a long time, the drive parts may be consumed and the replacement cycle of consumables may be faster. For consumables, refer to the Web Guide.

⑪**[Zoom]**

Adjust the zoom manually.

[-]:Adjust the zoom factor to 1.0 times in the [Wide Angle] direction.

[x1]: Zoom (magnification) is 1.0 times.

[+]:Adjust the zoom factor in the [Telescope] direction.

⑫**[Focus]**

Adjust the focus manually.

[Auto]:Automatically adjust focus.

[Near]:Adjust the focus to the [Near].

[Far]:Adjust the focus to the [Far].



[Note:]

- The following subjects cannot be focused with auto focus. Focus manually.
 - Bright or intense light reflecting subjects
 - Subject over water droplets or dirty glass
 - Remote and nearby subjects mixed together
 - Subjects (white walls, etc.) without contrast
 - horizontal subject such as a blind
 - Oblique subject
 - Dark subject

⑬[Brightness adjustment] buttons

Adjust the brightness.

Press the [Light (+)] button to brighten the image.

Press the [Dark (-)] button to darken the image.

Press [Reset] to return to the default brightness.

⑭[Close] buttons

Hides the Setup menu.



[Note:]

- If the HTTP port number is changed from 80, [http://IP address:port number/]*¹
Enter the port number of the machine. If the DDNS function is used, [http://Host name registered on the DDNS server: Port number/]*³Please enter.
- If you are configuring [HTTPS] in [HTTPS]-[Connection] on the [Advanced] tab of the Network Page, enter the following.
[https://IP address:port number/] or [host name registered on the https:// DDNS server: port number/]
- When the Authentication dialog appears, enter the administrator's or general user's username and password. Depending on the mobile phone, the password may need to be entered each time the screen is switched.
- Depending on the tablet terminal, the image may not be displayed when the size of the image is large. This may be displayed when the [Image quality setting] of [JPEG] is close to low quality.
→9.2 [Image] for setting JPEG images
- You may not be able to access some tablets and contract plans.

2 Operation

2.4 Viewing images from mobile/tablet terminals

- *1 The IP address is the global IP address on the WAN side of the router that can be accessed from the Internet.
Note, however, that this is the local IP address when accessing the handset in the same LAN with a mobile terminal supporting wireless connection.
- *2 Only for accessing the computer via the Internet.
- *3 It is available only for users whose access levels are set to [1. Administrator].
- *4 When [User auth.] is set to [On], only users with access levels set to [1. Administrator] or [2. Camera control] can work.
→[13.1 \[User auth.\] to configure user-authentication](#)

2.4.2.3 Viewing Multi-directional Camera Images from a Tablet Terminal

- 1 [http://IP address] on the tablet terminal*¹Or [host name/ registered in the http://DDNS server]*²The image of the computer is displayed when you enter it and connect it to the computer.

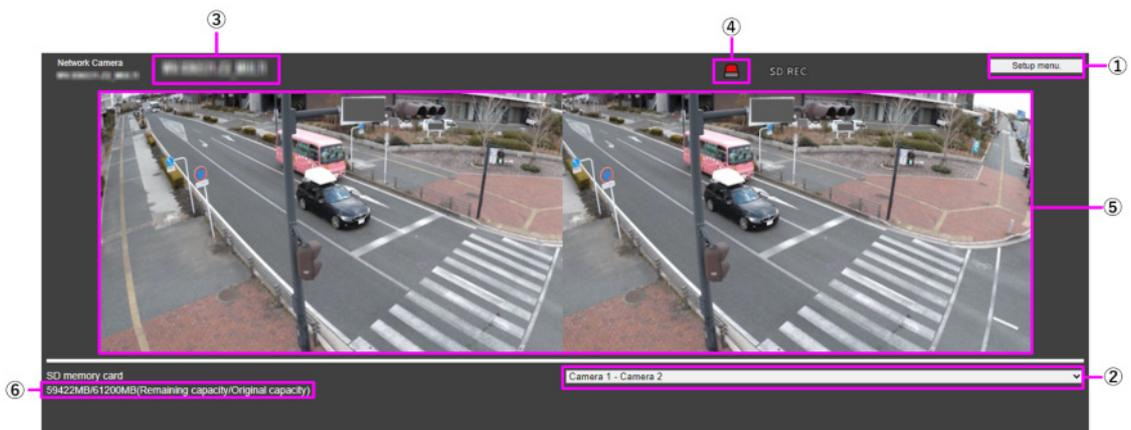

Setup MENU

When [Cam.1-2] is selected in [Display camera Switching] pull-down menu.

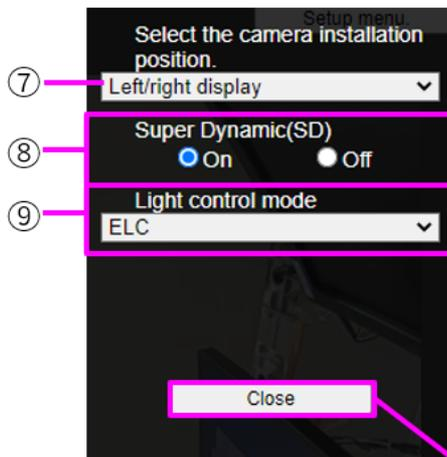

When [Cam.1],[Cam.2] is selected in [Display camera Switching] pull-down menu.

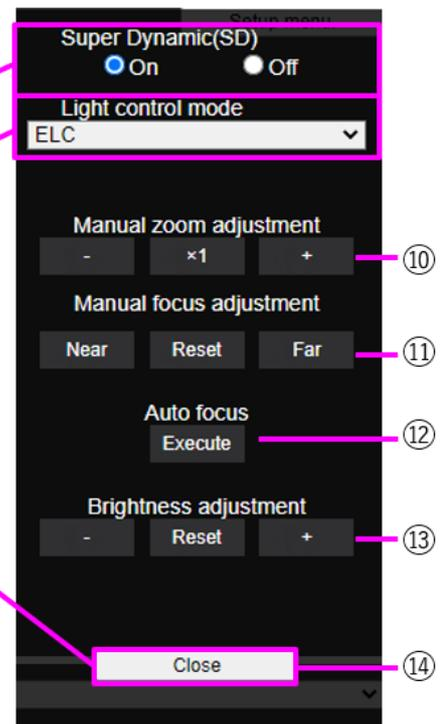

①[Setup menu.] buttons*3

Indicates the setup menu.

②[Switch Display Camera] pull down menu

The camera image displayed in the area ⑤ can be selected.

[Camera 1 to Camera 2]:Images of camera 1 and 2 are displayed at the same time. Displayed according to the settings in [⑦ Layout Setup pull-down Menu].

[Camera 1]:Image of camera 1 is displayed as a single image.

[Camera 2]:Image of camera 2 is displayed as a single image.

③[Camera title]

The title of the camera entered in [Camera title] on the [Basic] tab is displayed.

→3.2 [\[Basic\] to perform basic settings](#)

④[Alarm Notification] button*4

The lamp blinks when an alarm is generated. Click the button to disappear.



[Note:]

- The blinking of the alarm notification button is not linked to the alarm notification operation such as recording to the SD Memory Card or mail transfer. Check the setting of each operation.

⑤[Main area]

Live displays the camera image.

⑥[Capacity display]

The remaining capacity and total capacity of the SD Memory Card are displayed.

⑦[Layout Settings] pull-down menu

Select [Left/right display] or [Up/down display] as the layout of images to be displayed in the area ⑤. The Layout Setting pull-down menu is displayed when [Camera 1-Camera 2] is selected in the Display Camera Switching pull-down menu.

[Left/right display]: Images of cameras 1 and 2 are displayed in left-right alignment.

[Up/down display]: Images of cameras 1 and 2 are displayed in the upper and lower positions.

⑧[Super dynamic setting]

You can set [On] or [Off] to activate the super dynamic function. You can set for each preset position. See [What is Super Dynamic] for details on super dynamic.

[On]:The Super Dynamic function is activated.

[Off]:Stops the superdynamic function.



[Note:]

- Set [Super Dynamic] to [Off] when the following phenomena are observed depending on the lighting condition.
 - when flickering or color changes occur
 - when noise is generated in the bright area of the screen

⑨[Light control mode] pull-down menu

Select the mode to control the light intensity from the following.

[Flickless (50 Hz)]/[Flickless (60 Hz)]:Flicker is automatically corrected with a fluorescent lamp. 50 Hz/60 Hz will be used differently in different regions.

ELC:The electronic shutter is used to control the light intensity.

⑩[Manual zoom adjustment]

Adjust the zoom manually.

[-]: Adjust the zoom factor to 1.0 times in the [Wide angle] direction.

[x1]: Zoom (magnification) is 1.0 times.

[+]: Adjust the zoom factor in the [Telephone] direction.



[Note:]

- The zoom (magnification) switches between the optical zoom and EX optical zoom.



[Important]

- With the mask area, privacy zone, operation detection area, undesired detection area, and VIQS area set, setting the EX optical zoom will shift the position.

Therefore, set the EX optical zoom and then set each area.

→9.4.2 Set the mask area

→9.4.6 Setting the privacy zone (Privacy zone setting screen)

→12.6 [VMD area] to set the motion detection area

→12.8 [SCD area] to set up undesired detection areas

→9.4.8 Set up the VIQS area

⑪ **[Manual focus adjustment]**

Adjust the focus manually.

[Near]: Adjust the focus to the [Near].

[Reset] returns focus (focus) to its default settings.

[Far]: Adjust the focus to the [Far].



[Note:]

- One-click on the [Near] or [Far] buttons may appear to have no change in focus due to trace adjustments. If you want to move the focus position large, press and hold the button for a long time.

⑫ **[Auto focus]**

When [Execute] is clicked, the auto focus function is activated to automatically adjust the focus to the subject in the center of the picture.



[Important]

- If auto focus is executed while the slow shutter is running (e.g. at night) with the [Maximum shutter] set to a longer time than [1/30s maximum] (2/30s maximum), [4/30s maximum], [6/30s maximum], [10/30s maximum], or [16/30s maximum]), it may take a lot of time to complete auto focus.

- The focus may not be adjusted automatically in the following locations or subject. In this case, adjust the focus manually.

-Be a big move

- Large variation in illumination
- Low illumination-Extremely bright or reflected light
- Over the window
- where the dome cover is prone to contamination
- White walls are less dark.
- Flicker fiercely
- When the image is switched from color to black and white in the near infrared region, the focus may shift due to the optical characteristics. If [Focusing at Day & Night switching] is set to [Auto] or [Preset], the camera can focus automatically (it does not support the lighting change after the focus operation is completed).

⑬[Brightness adjustment] buttons

Adjust the brightness. The [Brightness adjustment] buttons are not displayed when [Camera 1 to Camera 2] is selected in the Show Camera switching pull-down menu.

Press the [Light (+)] button to brighten the image.

Press the [Dark (-)] button to darken the image.

Press [Reset] to return to the default brightness.

⑭[Close] buttons

Hides the Setup menu.



[Note:]

- If the HTTP port number is changed from 80, [http://IP address:port number/]*¹
Enter the port number of the machine. If the DDNS function is used, [http://Host name registered on the DDNS server: Port number/]*³Please enter.
- If you are configuring [HTTPS] in [HTTPS]-[Connection] on the [Advanced] tab of the Network Page, enter the following.
[https://IP address:port number/] or [host name registered on the https:// DDNS server: port number/]
- When the Authentication dialog appears, enter the administrator's or general user's username and password. Depending on the mobile phone, the password may need to be entered each time the screen is switched.
- Sound cannot be received from a tablet terminal.
- Depending on the tablet terminal, the image may not be displayed when the size of the image is large. This may be displayed when the [Image quality setting] of [JPEG] is close to low quality.
- You may not be able to access some tablets and contract plans.

2 Operation

2.4 Viewing images from mobile/tablet terminals

- *1 The IP address is the global IP address on the WAN side of the router that can be accessed from the Internet.
Note, however, that this is the local IP address when accessing the handset in the same LAN with a mobile terminal supporting wireless connection.
- *2 Only for accessing the computer via the Internet.
- *3 It is available only for users whose access levels are set to [1. Administrator].
- *4 When [User auth.] is set to [On], only users with access levels set to [1. Administrator] or [2. Camera control] can work.
→[13.1 \[User auth.\] to configure user-authentication](#)

2.4.2.4 Viewing images of the Multi-directional/PTZ camera from the tablet terminal

PTZ camera

- 1 [\[http://IP address\]](http://IP address) on the tablet terminal*¹Or [\[host name/ registered in the http://DDNS server\]](http://host name/)*²The image of the computer is displayed when you enter it and connect it to the computer.

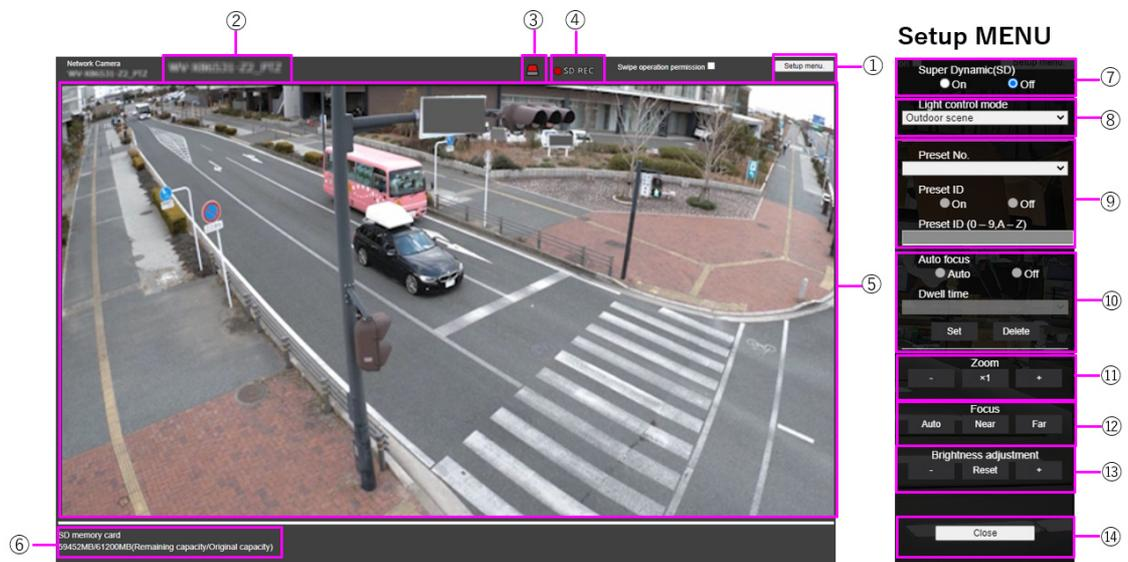

- ①[Setup menu.] buttons*3

Indicates the setup menu.

- ②[Camera title]

The title of the camera entered in [Camera title] on the [Basic] tab is displayed.

→[3.2 \[Basic\] to perform basic settings](#)

- ③[Alarm Notification] button*4

The lamp blinks when an alarm is generated. Click the button to disappear.



[Note:]

- The alarm notification button blinks in conjunction with the alarm notification operation such as mail transfer. Check the operation setting.

④[SD Storage Status Display]

Displays the storage status on the SD Memory Card. When saving starts, the SD save status indicator turns red. The LED turns OFF when saving stops.

This is displayed when the [Save trigger] in the Setup menu is set to [Manual] or [Schedule].

→8.2 [SD memory card] for setting SD Memory Cards

⑤[Main area]

Live displays the camera image.

⑥[Capacity display]

The remaining capacity and total capacity of the SD Memory Card are displayed.

⑦[Super dynamic setting]

You can set [On] or [Off] to activate the super dynamic function. You can set for each preset position. This cannot be set when [Image capture mode] is in [60 fps mode] or [50 fps mode]. See [What is Super Dynamic] for details on super dynamic.

[On]:The Super Dynamic function is activated.

[Off]:Stops the superdynamic function.



[Note:]

- Set [Super Dynamic] to [Off] when the following phenomena are observed depending on the lighting condition.
 - when flickering or color changes occur
 - when noise is generated in the bright area of the screen
- If [Light control mode] is set to [Fix shutter], [Super Dynamic] cannot be set to [On].
- When [Stabilizer] is set to [On], the superdynamic setting is [Off].

⑧[Light control mode] pull-down menu

Select the mode to control the light intensity from the following.

[Outdoor shooting]:The brightness (illumination) controls the light intensity by combining the electronic shutter and automatic aperture. This setting is used when shooting bright subjects such as outdoors. Be careful not to flicker under fluorescent lights, etc.

[Flickless (50 Hz)]/[Flickless (60 Hz)]:Flicker is automatically corrected with a fluorescent lamp. 50 Hz/60 Hz will be used differently in different regions.

[Fixed shutter]:

If [Image capture mode] is in 30 fps or 15 fps mode:

[1/30 fixed], [3/120 fixed], [2/100 fixed], [2/120 fixed], [1/100 fixed], [1/120 fixed], [1/250 fixed], [1/500 fixed], [1/1000 fixed], [1/2000 fixed], [1/4000 fixed], or [1/10000 fixed]

If [Image capture mode] is in 25 fps or 12.5 fps mode:

[1/25 fixed]/[3/100 fixed]/[2/100 fixed]/[1/100 fixed]/[1/250 fixed]/[1/500 fixed]/[1/1000 fixed]/[1/2000 fixed]/[1/4000 fixed]/[1/10000 fixed]

When [Image capture mode] is 60 fps:

[1/60 fixed]/[1/100 fixed]/[1/120 fixed]/[1/250 fixed]/[1/500 fixed]/[1/1000 fixed]/[1/2000 fixed]/[1/4000 fixed]/[1/10000 fixed]

If [Image capture mode] is in 50fps mode:

[1/50 fixed]/[1/100 fixed]/[1/250 fixed]/[1/500 fixed]/[1/1000 fixed]/[1/2000 fixed]/[1/4000 fixed]/[1/10000 fixed]



[Note:]

- If you increase the shutter speed ($\sim 1/10,000$), you will be less prone to blur even when the subject moves faster.
- Increasing the shutter speed decreases the sensitivity.
- If [Super Dynamic] is set to [On], [Fix shutter] cannot be set. To configure [Fix shutter], set [Super Dynamic] to [Off].
- [Indoor scene(60Hz)] cannot be set when [Image capture mode] is in 25fps, 50fps, or 12.5fps modes.

⑨ **[Preset position setting]**

Set the preset position.

Before registering the preset, move the camera in the direction you want to register.

To change the orientation of the camera, enable [Swipe operation permission] and select the image position to be centered on the image angle. The camera's orientation moves to a position centered on the clicked position.

If you want to zoom in, enable [Swipe operation permission] and select the zoom area in the picture.



[Important]

- When registering a preset position using a tablet, pay attention to the following.
 - If updating of the image on the tablet is slow, it is recommended that you register the preset while viewing the image on the confirmation monitor.
 - If you resize the screen with tablet operation, you may not be able to change the

orientation or zoom in on the screen.

-If you cannot adjust the orientation of the camera with the tablet operation, refer to the following to move the camera orientation in the direction you want to register.

→2.4.1 Viewing images from mobile devices (smartphones, etc.)

Preset No.

Set the position number to be registered.

Preset ID

Use [On] and [Off] to set whether the position name is displayed. You can set for each preset position.

[On]:Displays the position name.

[Off]:The position name is not displayed.



[Important]

• If you set [Preset ID], be sure to press [Register].



[Note:]

• When set to [On], the position name is displayed where you set the position in [Camera title position] on the [Basic] tab.

Preset ID (0-9,A-Z)

Enter the name to be displayed on the image. You can set for each preset position.

Number of characters that can be entered:0 to 40 characters

Input Characters:0-9 (single-byte), A-Z (single-byte, uppercase, lowercase), double-byte, single-byte symbol ! " # \$ % & ' () * + , - . / : ; = ?



[Important]

• If you set [Preset ID (0 – 9,A – Z)], be sure to press [Register].



[Note:]

• The position name entered is displayed next to the preset position number in the pull-down. If [Preset ID] is set to [On], it can also be displayed on the images.

⑩[Auto focus]

Use [Auto] and [Off] to set whether auto focus is performed after the preset is moved. You can set for each preset position.

[Auto]:Auto focus is performed after the preset is moved.

[Off]:Auto focus is not performed after moving the preset.



[Note:]

- When presetting a subject whose depth does not change, a subject whose contrast is low, or a subject with high brightness such as a spotlight, etc., set [Off] and register the preset position after setting the focus.

[Stopping time]

During the preset sequence operation, select the time to reflect the image of each preset position (the time when the camera stops rotating) from the following.

[5s]/ [10s]/ [15s]/ [20s]/ [25s]/ [30s]



[Note:]

- The preset position set to [Off] does not move to that position during the preset sequence, but instead moves to the next preset position.
- Depending on the stop time setting, the watch may move to the next preset position during auto focus operation.
- If the preset sequence function is used for a long time, the drive parts may be consumed and the replacement cycle of consumables may be faster. For consumables, refer to the Web Guide.

⑪[Zoom]

Adjust the zoom manually.

[-]:Adjust the zoom factor to 1.0 times in the [Wide Angle] direction.

[x1]: Zoom (magnification) is 1.0 times.

[+]:Adjust the zoom factor in the [Telescope] direction.

⑫[Focus]

Adjust the focus manually.

[Auto]:Automatically adjust focus.

[Near]:Adjust the focus to the [Near].

[Far]:Adjust the focus to the [Far].



[Note:]

- The following subjects cannot be focused with auto focus. Focus manually.
 - Bright or intense light reflecting subjects
 - Subject over water droplets or dirty glass
 - Remote and nearby subjects mixed together
 - Subjects (white walls, etc.) without contrast
 - horizontal subject such as a blind
 - Oblique subject
 - Dark subject

⑬[Brightness adjustment] buttons

Adjust the brightness.

Press the [Light (+)] button to brighten the image.

Press the [Dark (-)] button to darken the image.

Press [Reset] to return to the default brightness.

⑭[Close] buttons

Hides the Setup menu.



[Note:]

- If the HTTP port number is changed from 80, [http://IP address:port number/]*¹
Enter the port number of the machine. If the DDNS function is used, [http://Host name registered on the DDNS server: Port number/]*³Please enter.
- If you are configuring [HTTPS] in [HTTPS]-[Connection] on the [Advanced] tab of the Network Page, enter the following.
[https://IP address:port number/] or [host name registered on the https:// DDNS server: port number/]
- When the Authentication dialog appears, enter the administrator's or general user's username and password. Depending on the mobile phone, the password may need to be entered each time the screen is switched.
- Depending on the tablet terminal, the image may not be displayed when the size of the image is large. This may be displayed when the [Image quality setting] of [JPEG] is close to low quality.
→9.2 [Image] for setting JPEG images
- You may not be able to access some tablets and contract plans.

2 Operation

2.4 Viewing images from mobile/tablet terminals

- *1 The IP address is the global IP address on the WAN side of the router that can be accessed from the Internet.
Note, however, that this is the local IP address when accessing the handset in the same LAN with a mobile terminal supporting wireless connection.
- *2 Only for accessing the computer via the Internet.
- *3 It is available only for users whose access levels are set to [1. Administrator].
- *4 When [User auth.] is set to [On], only users with access levels set to [1. Administrator] or [2. Camera control] can work.
→13.1 [\[User auth.\] to configure user-authentication](#)

Multi-directional camera

- 1 [http://IP address] on the tablet terminal*¹Or [host name/ registered in the http://DDNS server]*²The image of the computer is displayed when you enter it and connect it to the computer.



Setup MENU

When [Cam.1-4],[Cam.1-3] is selected in [Display camera Switching] pull-down menu.

When [Cam.1],[Cam.2],[Cam3],[Cam.4] is selected in [Display camera Switching] pull-down menu.

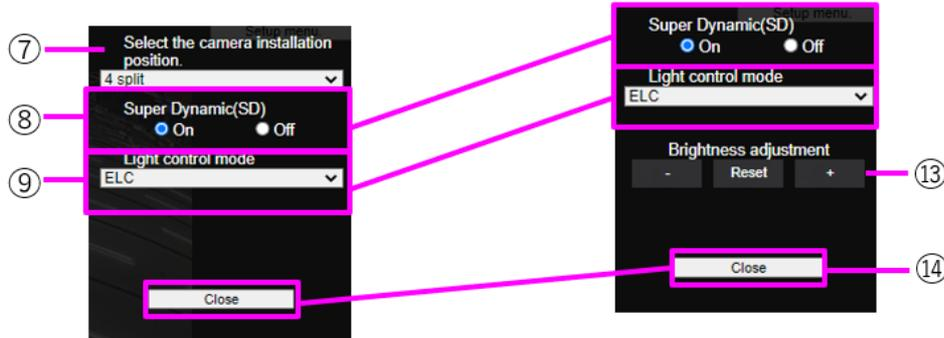

①[Setup menu.] buttons*3

Indicates the setup menu.

②[Switch Display Camera] pull down menu

The camera image displayed in the area ⑤ can be selected.

[Camera 1 to Camera 4]:Images of camera 1, 2, 3 and 4 are displayed at the same time.

Displayed according to the settings in [⑦ Layout Setup pull-down Menu].

[Camera 1 to Camera 3]:Images of camera 1, 2 and 3 are displayed at the same time. Displayed according to the settings in [⑦ Layout Setup pull-down Menu].

[Camera 1]:Image of camera 1 is displayed as a single image.

[Camera 2]:Image of camera 2 is displayed as a single image.

[Camera 3]:Image of camera 3 is displayed as a single image.

[Camera 4]:The image of camera 4 is displayed as a single image.

③[Camera title]

The title of the camera entered in [Camera title] on the [Basic] tab is displayed.

→3.2 [Basic] to perform basic settings

④[Alarm Notification] button*4

The lamp blinks when an alarm is generated. Click the button to disappear.



[Note:]

- The blinking of the alarm notification button is not linked to the alarm notification operation such as recording to the SD Memory Card or mail transfer. Check the setting of each operation.

⑤[Main area]

Live displays the camera image.

⑥[Capacity display]

The remaining capacity and total capacity of the SD Memory Card are displayed.

⑦[Layout Settings] pull-down menu

Select from [4 split], [360 deg.] and [270 deg.] for the layout of the images to be displayed in the area ⑤. The Layout Setting pull-down menu is displayed when [Camera 1] to [Camera 4] and [Camera 1] to [Camera 3] are selected from the Display Camera Switching pull-down menu.

[360-degree shooting]: Images of camera 1, 2, 3, and 4 are displayed side by side. Select this when you want to place camera 4 horizontally, such as when you want to take a wide range of pictures.

[270-degree shooting]: Images of camera 1, 2, and 3 are displayed side by side. Select this when you want to shoot a wide area.

[Divide into four pieces]: Images of cameras 1, 2, 3, and 4 are displayed in quadrants.

⑧[Super dynamic setting]

You can set [On] or [Off] to activate the super dynamic function. You can set for each preset position. See [What is Super Dynamic] for details on super dynamic.

[On]: The Super Dynamic function is activated.

[Off]: Stops the superdynamic function.



[Note:]

- Set [Super Dynamic] to [Off] when the following phenomena are observed depending on the lighting condition.
 - when flickering or color changes occur
 - when noise is generated in the bright area of the screen

⑨[Light control mode] pull-down menu

Select the mode to control the light intensity from the following.

[Flickerless (50 Hz)]/[flickerless (60 Hz)]: Flicker is automatically corrected with a fluorescent lamp. 50 Hz/60 Hz will be used differently in different regions.

ELC: The electronic shutter is used to control the light intensity.

⑩[Manual zoom adjustment]

Adjust the zoom manually.

[-]: Adjust the zoom factor to 1.0 times in the [Wide angle] direction.

[x1]: Zoom (magnification) is 1.0 times.

[+]: Adjust the zoom factor in the [Telephone] direction.



[Note:]

- The zoom (magnification) switches between the optical zoom and EX optical zoom.



[Important]

- With the mask area, privacy zone, operation detection area, undesired detection area, and VIQS area set, setting the EX optical zoom will shift the position.

Therefore, set the EX optical zoom and then set each area.

→9.4.2 Set the mask area

→9.4.6 Setting the privacy zone (Privacy zone setting screen)

→12.6 [VMD area] to set the motion detection area

→12.8 [SCD area] to set up undesired detection areas

→9.4.8 Set up the VIQS area

⑪ **[Manual focus adjustment]**

Adjust the focus manually.

[Near]: Adjust the focus to the [Near].

[Reset] returns focus (focus) to its default settings.

[Far]: Adjust the focus to the [Far].



[Note:]

- One-click on the [Near] or [Far] buttons may appear to have no change in focus due to trace adjustments. If you want to move the focus position large, press and hold the button for a long time.

⑫ **[Auto focus]**

When [Execute] is clicked, the auto focus function is activated to automatically adjust the focus to the subject in the center of the picture.



[Important]

- If auto focus is executed while the slow shutter is running (e.g. at night) with the [Maximum shutter] set to a longer time than [1/30s maximum] (2/30s maximum), [4/30s maximum], [6/30s maximum], [10/30s maximum], or [16/30s maximum]), it may take a lot of time to complete auto focus.

- The focus may not be adjusted automatically in the following locations or subject. In this case, adjust the focus manually.

-Be a big move

- Large variation in illumination
- Low illumination-Extremely bright or reflected light
- Over the window
- where the dome cover is prone to contamination
- White walls are less dark.
- Flicker fiercely
- When the image is switched from color to black and white in the near infrared region, the focus may shift due to the optical characteristics. If [Focusing at Day & Night switching] is set to [Auto] or [Preset], the camera can focus automatically (it does not support the lighting change after the focus operation is completed).

⑬[Brightness adjustment] buttons

Adjust the brightness. [Brightness adjustment] buttons are not displayed when [Camera 1] to [Camera 4] and [Camera 1] to [Camera 3] are selected from the [Display Camera Selection] pull-down menu.

Press the [Light (+)] button to brighten the image.

Press the [Dark (-)] button to darken the image.

Press [Reset] to return to the default brightness.

⑭[Close] buttons

Hides the Setup menu.



[Note:]

- If the HTTP port number is changed from 80, [http://IP address:port number/]*¹
Enter the port number of the machine. If the DDNS function is used, [http://Host name registered on the DDNS server: Port number/]*³Please enter.
- If you are configuring [HTTPS] in [HTTPS]-[Connection] on the [Advanced] tab of the Network Page, enter the following.
[https://IP address:port number/] or [host name registered on the https:// DDNS server: port number/]
- When the Authentication dialog appears, enter the administrator's or general user's username and password. Depending on the mobile phone, the password may need to be entered each time the screen is switched.
- Sound cannot be received from a tablet terminal.
- Depending on the tablet terminal, the image may not be displayed when the size of the image is large. This may be displayed when the [Image quality setting] of [JPEG] is close to low quality.
- You may not be able to access some tablets and contract plans.

- *1 The IP address is the global IP address on the WAN side of the router that can be accessed from the Internet.
Note, however, that this is the local IP address when accessing the handset in the same LAN with a mobile terminal supporting wireless connection.
- *2 Only for accessing the computer via the Internet.
- *3 It is available only for users whose access levels are set to [1. Administrator].
- *4 When [User auth.] is set to [On], only users with access levels set to [1. Administrator] or [2. Camera control] can work.
→[13.1 \[User auth.\] to configure user-authentication](#)

2.5 Manually save images on the SD memory card

You can manually save the image on the live image page to the SD Memory Card.

This function is available only when [Save trigger] is set to [Manual] by clicking the [SD memory card] tab on the Basic page of the Advanced Menu.

In the [Recording format] of the Advanced menus, you can select either JPEG or Stream to save. If JPEG is selected in [Recording format], a still image is saved. If Stream is selected, a movie is saved.



[Note:]

- [MULTI] [Recording format] can be set only for streams.
- [MULTI] Manually saves all camera movies at the same time.
- SD recording is not available when [Image capture mode] is set to [60fps Mode] or [50fps Mode].

- 1 Live image pages are displayed.
→[2.3.1 View camera images](#)
- 2 Click [Camera control] to view the [Camera control] panels.
- 3 [SD memory card]—starts saving to the SD Memory Card by clicking [Start] on the [Rec. on SD]. The SD save status indicator turns red during storage.
→[2.3.2 About live image pages](#)
The saved intervals are set on the [SD memory card] tabs of the basic pages.
→[8.2 \[SD memory card\] for setting SD Memory Cards](#)
- 4 To stop storing images on the SD Memory Card, press the [Stop] buttons for [SD memory

card]-[Rec. on SD]. The SD save status indicator turns OFF when saving is stopped.

- 5 Close the Camera Control Panel by clicking [Camera control].



[Note:]

- Images saved on the SD Memory Card can be downloaded from the Log List screen to the PC by clicking the [Start] button on the [Log/Play] button on the Live screen.

The download function allows saving to the PC.

→2.8.1 [When playing JPEG images stored on the SD Memory Card](#)

→2.8.2 [Play back the image of the stream stored on the SD Memory Card](#)

The destination for storing image data is the fixed directory in the SD Memory Card.

→18.3 [Directory structure of SD Memory Card](#)

- If you click the [Stop] button and then immediately click the [Start] button, the image may not be saved. If so, click [Start] again.
- To use this function correctly, format the SD Memory Card on your computer before using the SD Memory Card.

2.6 Operation when alarm is generated

When the following alarms are generated, the machine performs an alarm operation according to the setting (camera operation associated with alarm generation).

2.6.1 Alarm type

[Terminal alarm]:When an alarm device such as a sensor is connected to the alarm input terminal, an alarm is activated when the connected alarm device operates.

[VMD alarm]:When a change (movement) is detected in the image in the set operation detection area, an alarm is activated.

* Operation detection: VMD (Video Motion Detector) = Motion detection, Motion detector function

[Scene change detection (SCD) alarm]:The alarm is activated when the subject is changed by covering the camera with a cloth or a lid, or changing the camera direction significantly.

[Command alarm]:When a unique alarm notification is received from the connected device via the network, an alarm is activated.

[Audio detection alarm]:An alarm is activated when the set sound detection threshold is exceeded.

[Impact detection alarm]: When the set threshold for impact detection is exceeded, the alarm is activated.

[Casing open detection alarm]: Alarm is activated when the front cover of the camera is opened or closed.

Alarm Notification from Function Extension Software:When the function extension software with an alarm function is installed, an alarm is activated when an alarm is generated by the function extension software.

2.6.2 Operation when alarm is generated

[Displaying alarm notification on live image page](#)

When an alarm is generated, the alarm notification is displayed on the [Live] page.

→[2.3.2 About live image pages](#)

[Notify the device connected to the output terminal of the alarm](#)

When an alarm is activated, a signal can be output from the output terminal to sound an alarm, etc. The outputs are set on the [Alarm] tabs of the alarm pages.

→[12.2 \[Alarm\] for setting the output terminal](#)

[Save images on the SD Memory Card](#)

When an alarm is activated, images (JPEG/H.265/H.264) are saved on the SD Memory Card. To save images on the SD Memory Card, use the [SD memory card] tab on the basic page and the [Alarm] tab on the alarm page.

→[8.2 \[SD memory card\] for setting SD Memory Cards](#)

→[12.1 \[Alarm\] to set alarm operation](#)

[Notify the alarm by e-mail](#)

When an alarm is generated, an e-mail notifying that an alarm has occurred (alarm notification) is sent to the previously registered e-mail address. You register up to four mail messages to send alarms. You can also attach a still image to send an alarm mail. Alarm mail is set on the [Alarm] tab of the alarm page and on the [Advanced] tab of the network page.

→[12.1 \[Alarm\] to set alarm operation](#)

→[14.2.1 Set mail sending](#)

[Notifies that an alarm has occurred at the specified address \(unique alarm notification\)](#)

This function is useful when using devices manufactured by us (network disk recorder, etc.). When [TCP alarm notification] is set to [On], the computer can be notified that it is in the alarm condition. You can set your own alarms by using the [Notification] tabs on the alarm pages.

→[12.12.1 Set unique alarm notification](#)

Notifying that an alarm has occurred on the specified HTTP server (HTTP alarm notification)

When an alarm is generated, the alarm is sent to the pre-registered HTTP server. You can register up to five notified HTTP servers. You can also set the URL you want to send to the HTTP server. The HTTP alarm is set on the [Notification] tab of the alarm page.

→[12.12.2 Set the HTTP alarm notification](#)

2.7 Display the log list

The following history is displayed in the list.

Alarm Log:The alarm date and time, recording period, and alarm cause can be checked.

Manual/Schedule Storage Log:You can check the log and recording period when saved manually or in schedule settings.

- 1 Live image pages are displayed.
- 2 Press the [View Camera Control Panel] button to display the camera control panel.
- 3 SD Memory Card-When the [Start] button of the [Log/Play] is clicked, the Log List window is displayed in a separate window.

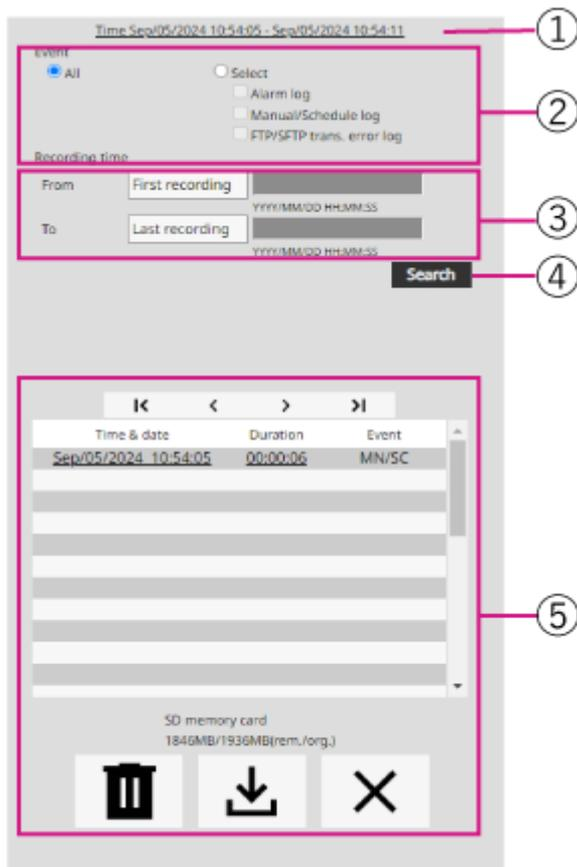



[Important]

- The log list display screen cannot be accessed by multiple users simultaneously.

① **Recording period**

Displays the period of recording saved on the SD Memory Card.

② **Recording stream**

Select the recording stream in which you want to view the log.

[Camera 1]:For Camera 1, the logs recorded by [Recording stream] are displayed.

[Camera 2]:For Camera 2, the logs recorded by [Recording stream] are displayed.

[Camera 3]:The logs recorded by [Recording stream] are displayed for Camera 3.

[Camera 4]:For Camera 4, the logs recorded by [Recording stream] are displayed.



[Note:]

- [MULTI] Only Multi-directional cameras are selected for recording streams.
- [MULTI] When Image capture mode is in Quad/Dual mode, the recorded images include all the cameras, so any camera can be searched.

③ **Event**

Select the type of log that is displayed in the log list.

[All]:Displays all logs.

[Select]:Only the logs of the selected type are displayed.

- **[Alarm Log]:**Displays the log when an alarm is generated.
- **[Manual/Schedule Save Log]:**Displays the log for manual saving and schedule saving.

④ **Recording time**

Specify the duration of the log to be displayed in the log list.

[From]:Sets the start point of the period to be displayed in the log.

- **[First recording]:**The first log saved on the SD Memory Card is displayed.

- **[Today]:**Displays today's logs.

- **[Yesterday]:**Displays logs from yesterday to today.

- **[Last 7 days]:**Displays logs from 6 days ago to the present day.

- **[Last 30 days]:**Displays logs from 29 days ago to today.

- **[Date/time]:**Displayed from the date and time log entered in the date and time specification box.

To:When [First recording] and [Date/time] are set in [Start], set the end of the time period to be displayed in the log.

- **Last recording:**Displays the last log saved on the SD Memory Card.

-**Date/time**:The date and time log entered in the Date and Time Setting box is displayed.

⑤ **Search button**

[Event] searches for logs according to the condition specified by [Recording time]. The search results are displayed in the log list.

⑥ **Log list**

The log search results are displayed. [Time] allows playback of recorded data by clicking [Record Period].

⏪(top) button:Displays the first log.

⏪(Previous page) button:Displays the log list for the previous page.

⏩(Next page) button:Displays the log list for the following pages.

⏪(Last) button:Displays the last log.

[Time & data]:Displays the date and time the log was recorded.



[Note:]

- If [Time display format] is set to [24h], the alarm date and time is displayed in 24-hour format.
- The timing of logging is as follows.
 - [Alarm Log]**:The date and time of the alarm is logged.
 - [Manual/Schedule Save Log]**:The date and time when saving to the SD Memory Card was started by manual or schedule setting is recorded as a log. To save continuously, logs are logged at hourly intervals (12 o'clock, 1 o'clock, 2 o'clock, etc.) when [Recording format] is JPEG. Also, when [Recording format] is streamed, logs are logged every hour from the beginning of recording.

[Duration]:Displays the length of time data was saved on the SD Memory Card.



[Note:]

- The difference between the recording end time and the recording start time is rounded to the nearest 0.1 second. Therefore, when only one JPEG image is recorded, the recording time is displayed as 00:00:00.

[Event]:Displays the cause of the log.

-MN/SC: Logs by Manual Save and Schedule Save

- TRM1: Alarm caused by alarm input to terminal 1
- TRM2: Alarm caused by alarm input to terminal 2
- TRM3: Alarm caused by alarm input to terminal 3
- VMD: Alarm due to operation detection alarm
- SCD: Alarm due to undesired detection alarm
- IMPACT: Alarm by Impact detection alarm
- CASING: Alarm by Opening detection alarm
- COM: Command Alarm
- AT: Alarm due to automatic tracking alarm
- INT: Intrusion alarm by AI-VMD
- LOI: Alarm on AI-VMD
- DIR: Direction alarm with AI-VMD
- CLD: Line cross alarm with AI-VMD



[Note:]

- The factors displayed differ depending on the function of the model.
- Refer to the catalog specifications for the functions installed in each model.

[SD memory card]:Displays the remaining capacity and total capacity of the SD Memory Card.

 **[Delete] button:**Deletes the log list for all pages. When searched, the retrieved "b" Deletes the list only. The image associated with the deleted log list is also deleted.



[Important]

- If the SD Memory Card contains a lot of recorded data, it may take several hours to complete deletion. In such a case, format it. However, all images are deleted by formatting.
- During deletion, saving by alarm, manual saving, and schedule saving are not available.
- Do not turn off the power to the computer until deletion is complete.
If the computer power is turned off during operation, data may remain on the SD Memory Card. In this case, again on the log list screen where the deletion operation was performed  Click the button.

 **[Download] button:**You can download the total number of logs in the displayed list to the PC.



[Note:]

- You can download up to 50,000 logs per SD Memory Card. If the number exceeds 50,000, it is overwritten from the old log. If the total number of log lists is large, it may take longer to download.

✕[Close] button: Closes the Log List screen.

2.8 Play back images on the SD Memory Card

Click Time in the Log List window to switch the live image page to the Playback page. The display format varies depending on the [Recording format] of the SD Memory Card.



[Important]

- The image updating speed may be slow during playback or downloading of the image.
- If the number of images stored on the SD Memory Card is large, it may take a long time before the images are displayed on the playback page.
- When the aspect ratio is [4:3], the image is displayed in VGA size on the playback page regardless of the resolution of the image stored on the SD Memory Card. When the aspect ratio is [16:9], the image is displayed in [640x360] on playback pages regardless of the resolution of the image stored on the SD Memory Card. Therefore, the playback page may look rough.
- During recording to the SD Memory Card, the playback updating speed may be slow. · When playing back images recorded in H.265, the recording bit rate may be displayed at refresh intervals if it is high.



[Note:]

- [MULTI] Multiple cameras cannot be played simultaneously except in Quad/Dual mode. Playback depends on the camera.

2.8.1 When playing JPEG images stored on the SD Memory Card

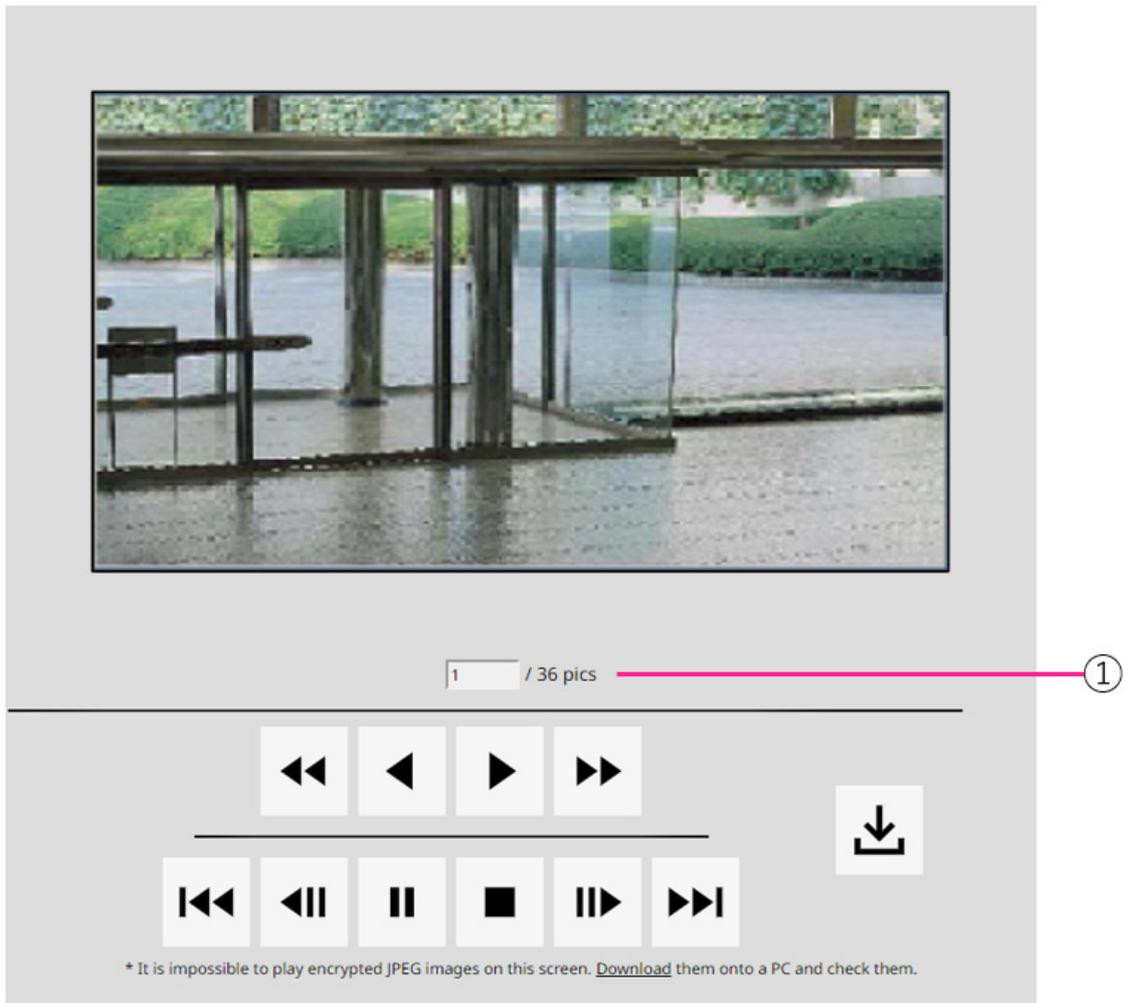

If the SD Memory Card contains an image associated with the date and time of clicking, the first image is displayed.

⑧ Number of images

The total number of images saved at the time of clicking and the number of images being displayed are displayed.



[Note:]

- Enter the number of the image to be displayed and press Enter on the keyboard.
The image with the specified number is displayed on the screen.

◀ **[Fast Reverse Playback] button**

Each time the button is clicked, the playback speed is switched.

During high-speed reverse play ▶ Buttons, ▶ Click the button to return to the normal playback

speed.

◀ **[reverse playback] button**

Play back to the previous image.

▶ **[Play] button**

Play back images in sequence.

⏩ **[high-speed playback] button**

Each time the button is clicked, the playback speed is switched.

During high-speed playback ◀ Buttons, ▶ Click the button to return to the normal playback speed.

⏪ **[top] button**

Displays the first image.

⏮ **[reverse frame advance] button**

Click the button during playback to display the previous image and pause it.

Click Pause to display the previous image each time you click the button.



[Note:]

• Press and hold the button to count the number of images.

When the button is released, the countdown of the image number stops and the image of the number when the button is released is displayed.

⏸ **[Pause] button**

Click during playback to pause playback.

Click during pause to resume playback.

■ **[Exit] button**

Exit the playback and return to the live image page.

⏭ **[frame advance] button**

Click the button during playback to display the following image and pause it.

Click Pause to display the following image for each click of the button.



[Note:]

- Press and hold the button to count the number of images. Releasing the button stops counting up the image number and displays the image of the number when the button is released.

»» **[Last] button**

Shows last image.

⬇ **[download] button**

The selected image is downloaded to the PC.

Check the browser settings used for the destination directory of the PC.

⬇ Click the button to display the download window. Click OK in the download window.



[Note:]

- During download, the playback screen cannot be operated. Operation should be completed after downloading.
- If [Cancel] is clicked during download, the download will be cancelled. The video data downloaded prior to clicking [Cancel] is saved to the computer.
- Since video data is stored in about 60 MB of files, multiple files are downloaded for data larger than 60 MB.
- H.264 movies saved on a PC can be played back using Windows Media® Player. Provided, however, that we do not warrant the operation of these software.
- Depending on the status of the SD Memory Card or Windows Media Player, H.264 movies may not be played.
- For H.265 video playback, please refer to our technical information website <Control No. C0303>.

2.8.2

Play back the image of the stream stored on the SD Memory Card



[Important]

- Depending on your network environment, downloading of movies may fail. If playback is in progress, it may be possible to download it by performing it again after stopping playback.
- Depending on the network environment and the camera status, you may not be able to perform each operation continuously on this screen.

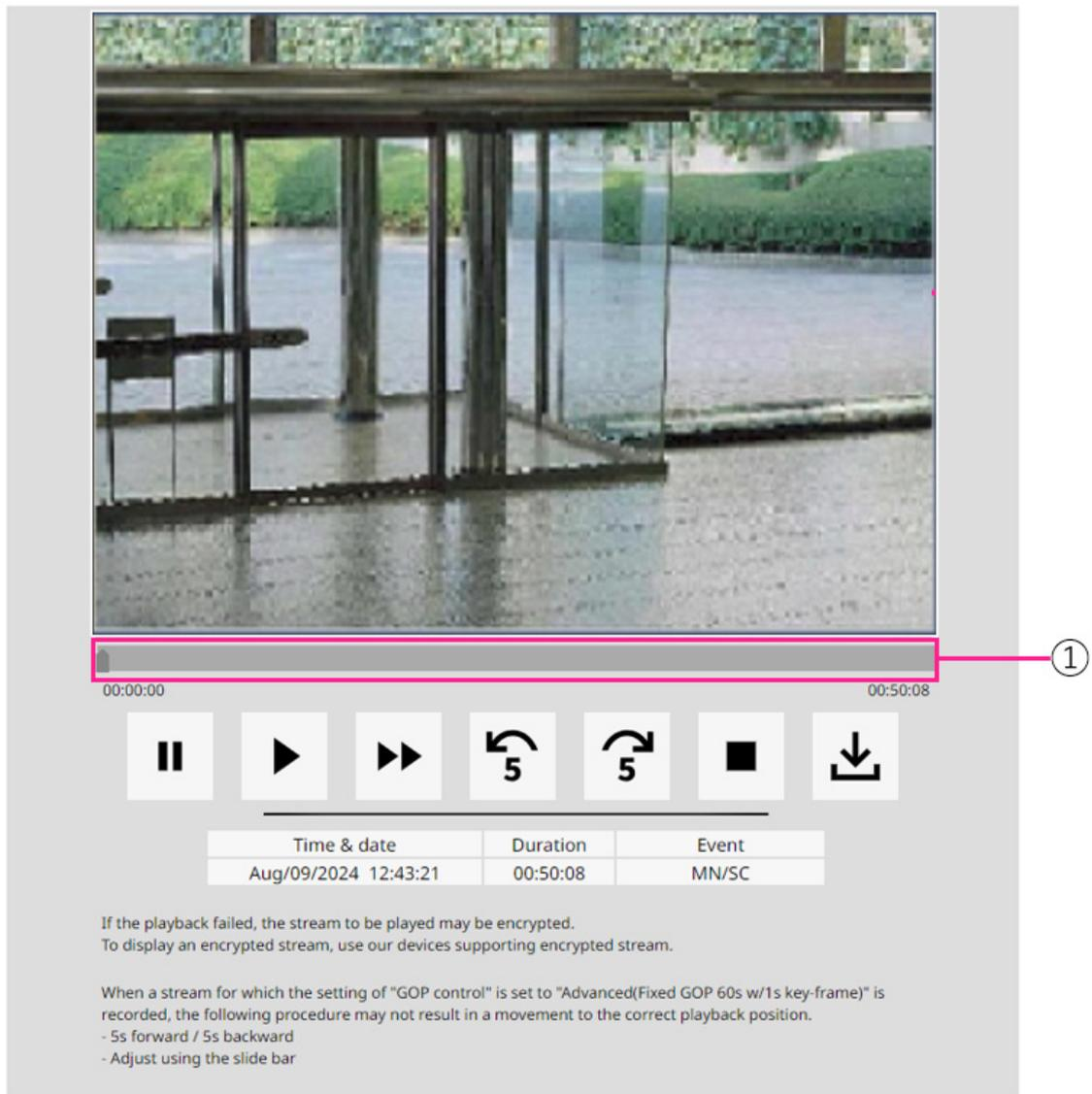

①Slider bar

You can press the slider bar and play it from any position. Operation is available only before start of playback, during pause, and after completion of playback.



[Note:]

- Move the slider bar to the I-picture at the position where you move it. For this reason, if streams with [GOP control] set to [Advanced (fixed GOP 60s + 1s keyframe)] are recorded, the movable position will be 60 seconds apart.

▣ [Pause] button

Click during playback to pause playback.

▶ [Play] button

Play recorded data.



[Note:]

- When audio data is recorded, the recorded data is also played, but the image and sound are not synchronized. Therefore, there may be a slight deviation between the image and sound. During recording to the SD Memory Card, audio playback may be interrupted or sound quality may deteriorate.
- When playing back recorded data, the image updating speed of live movies or playback may be slow.
- If the [Audio transmission mode] in the [Audio] tab of the video/audio pages is [Off] or [Interactive(Half-duplex)], the recorded data will not be played.

▶ **[high-speed playback] button**

Each time the button is clicked, the playback speed is switched.

During high-speed playback ▶ Click the button to return to the normal playback speed.



[Note:]

- The maximum speed of high-speed playback depends on the setting of [Stream recording]-[Max bit rate] on the SD Memory Card.
- During high-speed playback, the recorded data is not played.
- During high-speed playback, the display may be slowed or the display time may be skipped depending on the setting of [Stream recording]-[Max bit rate].

⏮ **[5-second return] button**

Each time the button is clicked, the returned recorded data is played back 5 seconds before.



[Note:]

- If streams with [GOP control] set to [Advanced (Fixed GOP 60s + 1s keyframe)] are recorded, the playback position may be returned for more than 5 seconds depending on the length of time the I picture is recorded.

⏭ **[5-second feed] button**

Each time the button is clicked, it advances to the next 5 seconds and plays back the recorded data.



[Note:]

- When the streams set to [Advanced (fixed GOP 60s + 1s keyframe)] in [GOP control] are recorded, the playback position may be returned depending on the length of time the I picture is recorded.

■ **[Exit] button**

Exit the playback and return to the live image page.

[Time & data]

Displays the date and time the log was recorded.

[Duration]

Displays the time when the data is saved on the SD Memory Card.

[Event]

Displays the cause of the log.

- MN/SC: logs saved manually and saved in schedule
- TRM1: Alarm due to alarm input to terminal 1
- TRM2: Alarm caused by alarm input to terminal 2
- TRM3: Alarm caused by alarm input to terminal 3
- VMD: Alarm due to operation detection alarm
- SCD: Alarm due to undesired detection alarm
- IMPACT: Alarm by Impact detection alarm
- CASING: Alarm by Opening detection alarm
- COM: Command Alarm
- AT: Alarm due to automatic tracking alarm
- INT: Intrusion alarm by AI-VMD
- LOI: Alarm on AI-VMD



[Note:]

- The content displayed on the [Event] depends on the function of the model.
- Refer to the catalog specifications for the functions installed in each model.

⬇ [download] button

The selected recorded data is downloaded to the PC.

Check the browser settings used for the destination directory of the PC.

⬇ Click the button to display the download window. Click OK in the download window.



[Note:]

- During download, the playback screen cannot be operated. Operation should be completed after downloading.
- If [Cancel] is clicked during download, the download will be cancelled. The video data downloaded prior to clicking [Cancel] is saved to the computer.
- Since video data is stored in about 60 MB of files, multiple files are downloaded for data larger than 60 MB.

- H.264 movies saved on a PC can be played back using Windows Media® Player.
Provided, however, that we do not warrant the operation of these software.
- Depending on the status of the SD Memory Card or Windows Media Player,
H.264 movies may not be played.
- For H.265 video playback, please refer to our technical information website
<Control No. C0303>.

3 Setting

This chapter explains the items that can be set from the camera's live image.

You can set general items for each function in live pictures.

For items that cannot be set from live pictures, set them from the Advanced menu.

For how to display live pictures, refer to the following.

→[2.3 Viewing images from a PC](#)

For details on how to set each item from the Advanced menu, refer to the following.

→[5.3 Camera Advanced Menu Screen](#)



•Refer to the catalog specifications for the functions installed in each model.

3.1 Displaying the configuration panel from the PC

The main settings of the camera are made on the Setup panel.



[Important]

•Configuration panels can only be operated by users with [1. Administrator] access levels. For details on how to set the access level, refer to the following.

→[13.1 \[User auth.\] to configure user-authentication](#)

3.1.1 How to display

1 Displays Live image pages.

→[2.3.1 View camera images](#)

2 In the Live image pages  Click the button to display the setting panel.

Press again to hide it. For more information on this panel, please refer to the following.

→[3.1.3 Setting Panel Screen](#)

3 Setting

3.1 Displaying the configuration panel from the PC

3.1.2 How to operate

- 1 Click on each tab in the Settings panel.

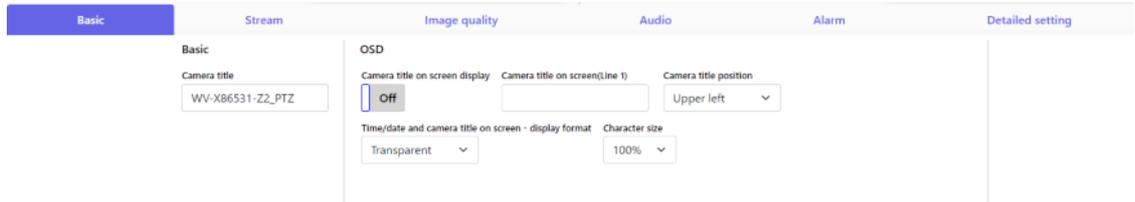

- 2 Enter each item on the setting page.



[Note:]

- Some items cannot be set depending on the main area display.

If the desired item is not displayed,  Click or press the scroll bar to display the items you want to set.

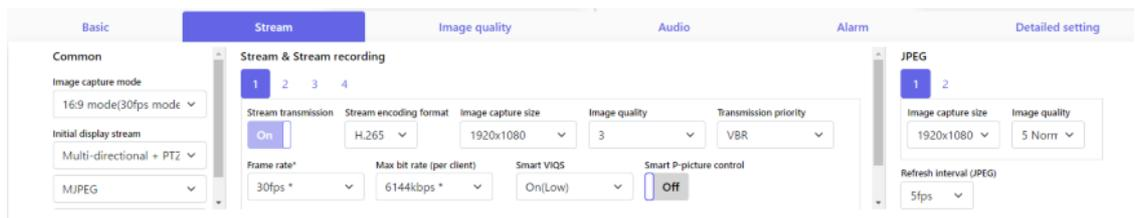

- 3 Once the entry is complete, click to confirm the entry if [Set] is available. Otherwise, it is confirmed when the set value is selected.



[Important]

- If there are several buttons in the [Set], [Register], and [Execute] pages, click the [Set], [Register], and [Execute] buttons for each item.

3.1.3 Setting Panel Screen



[Note:]

- Refer to the catalog specifications for the functions installed in each model.

Fixed cameras

3 Setting

3.1 Displaying the configuration panel from the PC

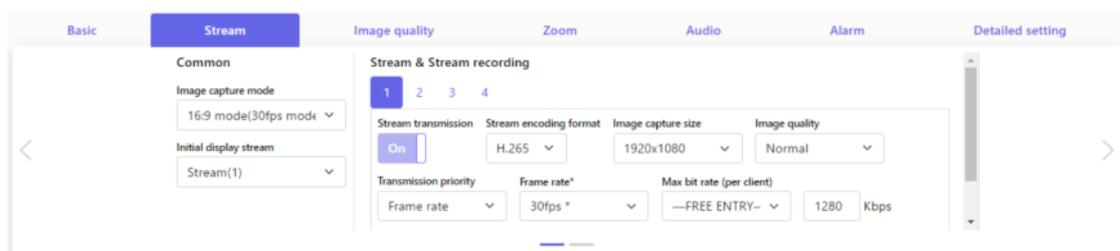

PTZ camera

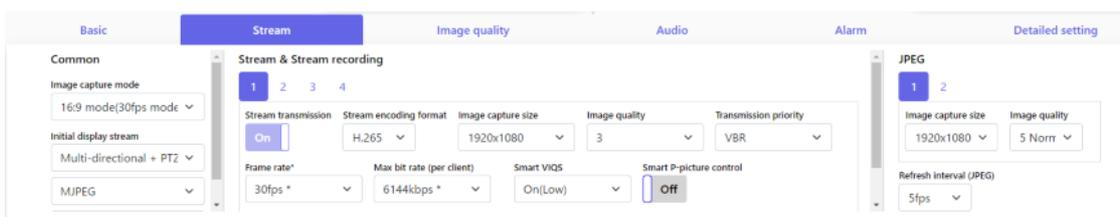

Multi-directional camera

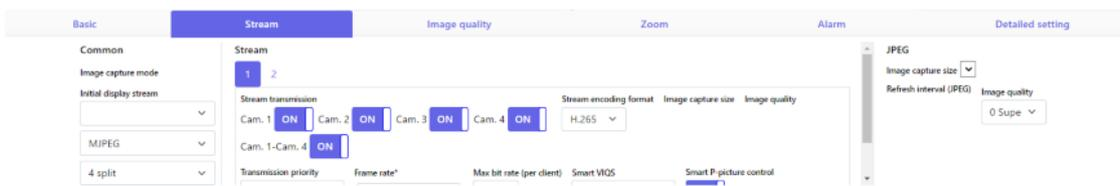

① [Basic] tabs

[Basic] displays the tabs. On the [Basic] tab, you can set the camera titles and display characters.

→[3.2 \[Basic\] to perform basic settings](#)

② [Stream] tabs

[Stream] displays the tabs. On the [Stream] tabs, you can set up imaging modes, JPEGs, streams, etc.

→[3.3 \[Stream\] for setting images](#)

③ [Image quality] tabs

[Image quality] displays the tabs. In the [Image quality] tabs, you can set the image quality.

→[3.4 \[Image quality\] for setting image quality](#)

④ [Zoom]Tab

[Zoom] displays the tabs. On the [Zoom] tab, you can set zooming and other settings.

→[3.5 \[Zoom\] for setting EX zoom](#)

→[3.6 \[Zoom\] for setting EX optical zoom](#)

→[3.7 \[Zoom\] for set zoom/focus](#)

⑤ [Audio] tabs

[Audio] displays the tabs. The [Audio] tabs configure audio-related settings.

→3.8 [Audio] for setting sound

⑥ [Alarm] tabs

[Alarm] displays the tabs. The [Alarm] tabs configure the alarm settings.

→3.9 [Alarm] to set alarm

⑦ [Detailed setting] tabs

[Detailed setting] displays the tabs. On the [Detailed setting] tabs, you can migrate to advanced settings and set up control panels.

→3.10 [Detailed setting] for switching to advanced settings and setting related to the displayed images

3.2 [Basic] to perform basic settings

The [Basic] tabs set the camera titles and display settings. See the [Basic] tabs on the Advanced Basic Page for a detailed explanation of the settings and notes for settings.

→8 [Basic] for basic setup of the machine



[Note:]

• Refer to the catalog specifications for the functions installed in each model.

[Basic]

Set basic items such as camera title.

• [Camera title]

Enter the this product name. The entered name is displayed in the camera title.



[Note:]

• [MULTI] [Image rotation] by cameras [date and time]&Set in [Characters on Screen].

Date and time&Characters on screen

Specify the display position and size of the character string to be displayed on the screen.

• [Camera]

Select from [Camera 1] to [Camera 4] to individually set the following items for the selected

camera.

- [Image rotation]
- [Camera title on screen display]
- [Camera title on screen(Line 1)]
- [Camera title on screen(Line 2)]
- [Camera title position]
- Date and time&In-screen text display format
- [Character size]



[Note:]

- [MULTI] Only the Multi-directional camera can be selected for [Camera].
- [MULTI] [Image rotation] can be selected for 2-eye Multi-directional cameras only.
- **[Image rotation]**
Select from [0° (Off)], [90°] and [180° (Upside-down)], and [270°].
- **[Camera title on screen display]**
Use [On]/[Off] to set whether the strings are displayed on the images.
When set to [On], the character strings entered in [Camera title on screen] are displayed at the position selected in [Position].
- **[Camera title on screen(Line 1)] / [Camera title on screen(Line 2)]**
Enter a character string to be displayed in the image.
- **[Camera title position]**
Select the position where the character string is displayed in the image.
- **[Time/date and camera title on screen – display format]**
Sets the display format to either [Permeation] or [Opaque].
- **[Character size]**
Select the date and time displayed in the image and the character size of the character string.

[Installation position]

- **[Tilt adjustment lever position]**
Select the [Tilt adjustment lever position] set when the cameras are installed.

3.3 [Stream] for setting images

The [Stream] tabs configure settings for JPEG, H.265, and H.264 images.

For a detailed explanation of the settings and notes for setting, refer to the [Image] tabs on the image/audio pages in the detailed settings.

→9.1 [Image] to set the imaging modes



[Note:]

• Refer to the catalog specifications for the functions installed in each model.

[Common]

Set the common items for JPEG and stream.

- [Image capture mode]
Select the image to be displayed on the live image, etc.
- [Initial display stream]
Select the image to be displayed on the live image page.

[Stream]

Select the number of the stream and set the [Stream transmission].

- [Stream transmission]
On/Off sets whether to deliver H.265 (or H.264) images.
- [Stream encoding format]
Select the compression method for the stream to be delivered.
- [Image capture size]
Select the resolution of the H.265 (or H.264) image.
- [Image quality]
Select the quality of the H.265 (or H.264) image.
- [Transmission priority]
Set the stream delivery mode.
- [Frame rate*]
Sets the frame rate.
- [Max bit rate (per client) *]
Select the H.265 (or H.264) bit rate for one client.
- [Auto VIQS]

Images are distributed so that the quality of images in moving places is high and the amount of data in other places is low.

- **[Smart VIQS]**

Images are distributed so that the amount of data decreases while maintaining high image quality in areas with objects (head, people, cars and motorcycles) and low/medium/medium image quality in other areas.

- **[Smart P-picture control]**

To reduce the amount of data, control the generation of data (macroblock) as little as possible except where there is an object (head, person, car, or motorcycle).

- **[GOP control]**

The GOP control reduces the amount of data.

[JPEG]

Configure the JPEG [Image capture size] [Image quality] [Transmission interval].

- **[Image capture size]**

When displaying JPEG images, select the resolution of the images to be displayed.

- **[Image quality]**

Set the quality of JPEG images at each resolution.

- **[Refresh interval(JPEG)]**

Select the rate at which the JPEG image is updated from the following.

3.4 [Image quality] for setting image quality

On the [Image quality] tabs, you set image quality.

For a detailed explanation of the settings and notes for setting, refer to the [Image quality] tabs on the image/audio pages in the detailed settings.

→9.4 [Image quality] to set the image quality

[Image quality]

You can set various image quality adjustments such as brightness and sharpness level.



[Note:]

- [MULTI] Only Multi-directional cameras can be selected for [Camera selection].
- [MULTI] This item is not displayed when [Image capture mode] is in Quad/Dual mode.
- [MULTI] For [Common(Cam. 1-2)], [Super Dynamic], [Light control mode],

[White balance], and [Intelligent Auto] can be set only for items that have not been developed in detail. To perform other advanced settings, select each camera.

- **[Camera selection]**

Select the camera to set the image quality.

- [Common(Cam. 1-2)]: Sets the same settings for the cameras.
- [Camera 1]: Sets camera 1 image quality.
- [Camera 2]: Sets camera 2 image quality.
- [Camera 3]: Sets the image quality of camera 3.
- [Camera 4]: Sets camera 4 image quality.

- **[Brightness]**

Adjust the brightness.

Move the slider bar in the [+] direction to brighten the image.

Move the slider bar in the [-] direction to darken the image.

Press [Reset] to return to the default brightness.

- **[Sharpness level]**

Adjust the sharpness level (contour correction).

Moving the slider bar in the direction of [+] results in a sharp contour, and moving the slider bar in the direction of [-] results in a soft contour.

Press [Reset] to return to the default settings.

- **[Maximum gain]**

Adjust the maximum gain. When the subject's illumination becomes dark, the gain automatically increases and the screen brightens.

Increasing the gain may increase the noise.

Move the slider bar in the [+] direction to increase the maximum gain.

Move the slider bar in the [-] direction to reduce the maximum gain.

Press [Reset] to return to the default settings.

- **[Digital noise reduction]**

The digital noise reduction function automatically reduces noise at low illumination levels.

Move the slider bar in the direction of [+] to increase the effect of noise reduction. There may be a lot of afterimages.

Moving the slider bar in the direction of [-] reduces the noise reduction effect. There are fewer aftereffects.

Press [Reset] to return to the default settings.

- **[Super Dynamic]**

On/Off is used to specify whether or not the super dynamic function can be activated.

- **[Light control mode]**
Select the mode to control the light intensity.
- **[Maximum shutter]**
The maximum exposure time adjusts the maximum storage time of the sensor.
- **[D&N]**
Select the mode for switching between black and white images and color images.
- **[Intelligent Auto]**
Set ON/OFF whether the intelligent auto function is enabled or not.

3.5 [Zoom] for setting EX zoom

On the [Zoom] tab, you set the angle of view of the image displayed during zooming.

For a detailed explanation of the settings and notes for setting, refer to the [Image quality] tabs on the image/audio pages in the detailed settings.

→9.4.3 [Adjust the angle of view with the EX zoom](#)



[Note:]

- Refer to the catalog specifications for the functions installed in each model.

[Zoom]

Set the field of field of field.

- **[Camera selection]**
Select the camera to set EX zoom.



[Note:]

- [MULTI] Only Multi-directional cameras can be selected for [Camera selection].

- **[Extra zoom]**
X1: Zoom (magnification) is 1.0 times.
 - 🔍 Adjust the zoom factor to 1.0 times in the [Wide Angle] direction.
 - 🔍: Adjust the zoom factor in the [Telescope] direction.

3.6 [Zoom] for setting EX optical zoom

On the [Zoom] tab, you set the angle of view of the image displayed during zooming.

For a detailed explanation of the settings and notes for setting, refer to the [Image quality] tabs on the image/audio pages in the detailed settings.

→9.4.4 [Adjust the angle of view with the Ex optical zoom](#)



[Note:]

• Refer to the catalog specifications for the functions installed in each model.

[Zoom]

Set the field of field of field.

- [Extra optical zoom]

X1: Zoom (magnification) is 1.0 times.

🔍 Adjust the zoom factor to 1.0 times in the [Wide Angle] direction.

🔍: Adjust the zoom factor in the [Telescope] direction.

3.7 [Zoom] for set zoom/focus

Use Zoom and EX optical zoom to adjust the angle of view of the displayed image.

Adjust the focus by moving the lens focus to the optimal position. It can be adjusted manually or automatically.

→9.4.5 [Adjust the zoom/focus](#)



[Note:]

• Refer to the catalog specifications for the functions installed in each model.

[Zoom]

Set the field of field of field.

- [Camera selection]

Select the camera to set zoom and focus.

- **[Zoom ratio designation]**

Adjust the zoom and focus simultaneously.

Press the slider bar to zoom in or out the angle adjustment frame in the image.

When you adjust the zoom (magnification) in the "telephoto" direction, only the image adjustment frame is reduced and you can specify the zoom (magnification) while checking the angle of view after the zoom is executed.

When the zoom (magnification) is adjusted in the "Wide angle" direction, the image itself is reduced or the frame for the zoom angle adjustment is enlarged. You can specify the zoom (magnification) while checking the image size after the zoom is executed.

Adjust the angle of view adjustment frame, and click [Execute] to zoom. Then, automatically adjust the focus to the object in the center of the window using the auto focus function.

- **[Manual zoom adjustment]**

Adjust the zoom manually.

 Adjust the zoom factor to 1.0 times in the [Wide Angle] direction.

X1: Zoom (magnification) is 1.0 times.

: Adjust the zoom factor in the [Telescope] direction.

- **[Manual focus adjustment]**

Adjust the focus manually.

[Reset] returns focus (focus) to its default settings.

[Near]: Adjust the focus to the [Near].

[Far]: Adjust the focus to the [Far].

- **[Auto focus]**

When [Execute] is clicked, the auto focus function is activated to automatically adjust the focus to the object in the center of the window.

- **[Focusing at Day & Night switching]**

Select the focus adjustment method when switching between color image and black-and-white image from the following. For details, refer to our technical information website <Control No. C0315>.

3.8 [Audio] for setting sound

The [Audio] tabs configure audio-related settings.

For a detailed explanation of the settings and notes for setting, refer to the [Audio] tabs on the

image/audio pages in the detailed settings.

→9.5 [\[Audio\] for setting sound](#)



[Note:]

• Refer to the catalog specifications for the functions installed in each model.

[Audio]

Sets sound and volume items.

- **[Mic select]**

Select the microphone to use when receiving audio data.

- **[Mic input volume]**

Set the volume of sound input to the computer. This setting is reflected in the volume of sound (listening) on the computer and the volume at [Audio recording].

- **[Audio transmission mode]**

Set the communication mode for sending/receiving voice data between the computer and the PC.

- **[Audio input encoding format]**

Select the compression method for the earpiece sound.

- **[Audio volume control mode]**

Select how to use the volume cursor of the earpiece button on the live picture page.

3.9 [Alarm] to set alarm

The [Alarm] tabs configure the alarm settings.

See the [Alarm] tabs on the alarm pages for detailed explanations of setting values and notes for setting values.

→12 [\[Alarm\] to set the alarm](#)



[Note:]

• Refer to the catalog specifications for the functions installed in each model.

[Alarm]

Set terminal operation and alarm items.

- **[Terminal 1]**

Set the operation of terminal 1.

- **[Terminal 2]**

Set the operation of terminal 2.

- **[Terminal 3]**

Set the operation of terminal 3.

- **[VMD alarm]**

ON/OFF is used to specify whether or not to perform operation detection.

When set to [On], the entire area is specified in the operation detection area. To specify an arbitrary action detection area, set it on the [VMD area] tab of the alarm page of the advanced setting.

→[12.5 \[VMD area\] for setting motion detection](#)

The [VMD area] tabs on the advanced alarm pages are accessible from live picture links.

- **[Scene change detection (SCD) alarm]**

ON/OFF is used to specify whether or not to perform undesired detection.

When set to [On], the entire area is specified in the disturbance detection area. To specify an optional disturbance detection area, use the [SCD area] tabs on the alarm pages in Advanced Settings.

→[12.7 \[SCD area\] to set up undesired detection](#)

The [SCD area] tabs on the advanced alarm pages are accessible from live picture links.

- **[Audio detection alarm]**

ON/OFF is used to specify whether or not to perform sound detection.

When set to [On], all AI sounds are enabled. To configure the details of sound detection, use the [Audio detection] tabs on the alarm pages in Advanced Settings.

→[12.9 \[Audio detection\] for setting sound detection](#)

The [Audio detection] tabs on the advanced alarm pages are accessible from live picture links.

- **[Impact detection alarm]**

Use On/Off to set whether or not to perform impact detection.

When set to [On], impact detection is enabled. When setting the details of impact detection, set it in the [Impact detection] tab of the alarm page of the detail setting.

→[12.10 \[Impact detection\] for setting impact detection](#)

The [Impact detection] tab on the Advanced Alarm page can be accessed via the link in the live image.

- **[Casing open detection alarm]**

Use On/Off to set whether or not to perform opening detection.

When set to [On], opening detection is enabled. When setting the details of opening detection,

set it in the [Casing open detection] tab of the alarm page of the detail setting.

→12.11 [Casing open detection] for setting opening detection

The [Casing open detection] tab on the Advanced Alarm page can be accessed via the link in the live image.

- **[Alarm deactivation time]**

Sets the time when the alarm is detected and the detection operation is not executed. For example, if you set up an e-mail notification to a mobile terminal or a tablet terminal using an alarm, this setting prevents you from sending too much e-mail.

3.10 [Detailed setting] for switching to advanced settings and setting related to the displayed images



[Note:]

• Refer to the catalog specifications for the functions installed in each model.

Function extension software

- **[Ext. software] buttons**

Displays the menu for managing the function extension software and setting the schedule.

→6 [Ext. software] for managing and scheduling advanced software

Network

- **[Network] buttons**

The Network Settings menu is displayed.

→14 Networking configuration [Network]

Maintenance

- **[Maintenance] buttons**

This displays menus for checking the system log, software version upgrade, status check, and initialization of the computer settings.

→16 [Maintenance] to maintain the machine

Camera details

- **[Advanced settings page] buttons**

The Advanced menu is displayed.

→[5.3 Camera Advanced Menu Screen](#)

Screen setting

- **[Color]**

Select the background color of the operation panels and advanced menus from the [Light] [Dark].

→[2.3.2 About live image pages](#)

- **[Operation panel layout]**

Select the position of the control panel from [Right], [Left], and [Lower].

→[2.3.2 About live image pages](#)

4 About network security

4.1 Security function of the unit

This machine is equipped with the following security functions.



[Note:]

• Refer to the catalog specifications for the functions installed in each model.

- ① Restricting access by user/host authentication
Setting [On] in User Authentication/Host Authentication can restrict the users accessing the cameras.
→ [13.1 \[User auth.\] to configure user-authentication](#)
→ [13.2 \[Host auth.\] to configure host-authentication](#)
- ② Access restrictions due to HTTP port changes
You can prevent unauthorized access, such as port scanning, by changing the HTTP port number.
→ [14.1 Networking \[Network\]](#)
- ③ Encryption of Access by HTTPS Function
By using the HTTPS function, you can encrypt the access to the camera and increase the security of communication.
→ [14.2.5 Set up HTTPS](#)
- ④ Falsification detection
By using the falsification detection function, you can detect falsification of data recorded on the SD card.
→ [8.3 \[Alteration detection\] for detecting tampering](#)
→ [8.4 How to set up falsification detection](#)
- ⑤ SRTP communication
By using SRTP communication, the streaming data of the video data is encrypted in SSL, thus preventing peeps in the ID/PW.
→ [14.2.9 Configure SRTP](#)
- ⑥ IEEE 802.1X Network Access Control

IEEE 802.1X Network Access Controls prevent unauthorized access and eavesdropping by connecting a malicious PC to a free switching hub port in a LAN.

→ [13.4 \[IEEE 802.1X\] to configure IEEE 802.1X](#)



[Important]

- Image data, authentication information (user name, password), alarm mail information, DDNS server information, etc. may be leaked on the network. Take measures such as restricting access by user authentication or encrypting access by HTTPS.
- After the administrator has accessed the computer, be sure to close all browsers to enhance security.
- When using the SNMP feature in SNMPv1/v2, do not configure community names that you can easily guess. (e.g., public)

If you use a community name that you can guess easily, your computer's status may be leaked on the network or used as a stepping stone for unauthorized access to other devices.



[Note:]

- If you fail user authentication (authentication error) five or more times in 10 seconds from a PC with the same IP address, you will not be able to access the machine for 30 seconds.
- You can change the conditions and period when the machine becomes inaccessible.

→ [13.6 \[Security\] to configure security](#)

5 Displaying the camera settings menu from the PC

The camera can be set in the Setup menu.



[Important]

• Only users with [1. Administrator] access levels are allowed to access the Setup menus. For details on how to set the access level, refer to the following.

→ [13.1 \[User auth.\] to configure user-authentication](#)

5.1 How to display

- 1 Displays Live image pages.
→ [2.3.1 View camera images](#)
- 2 Displays the setting panel.
- 3 Click the [Detail setting] tabs.
- 4 Clicking [Advanced settings page] on the [Camera detailed setting] displays the Advanced menu.

For more information on this menu, please refer to the following.

→ [5.3 Camera Advanced Menu Screen](#)

5 Displaying the camera settings menu from the PC
5.2 How to operate

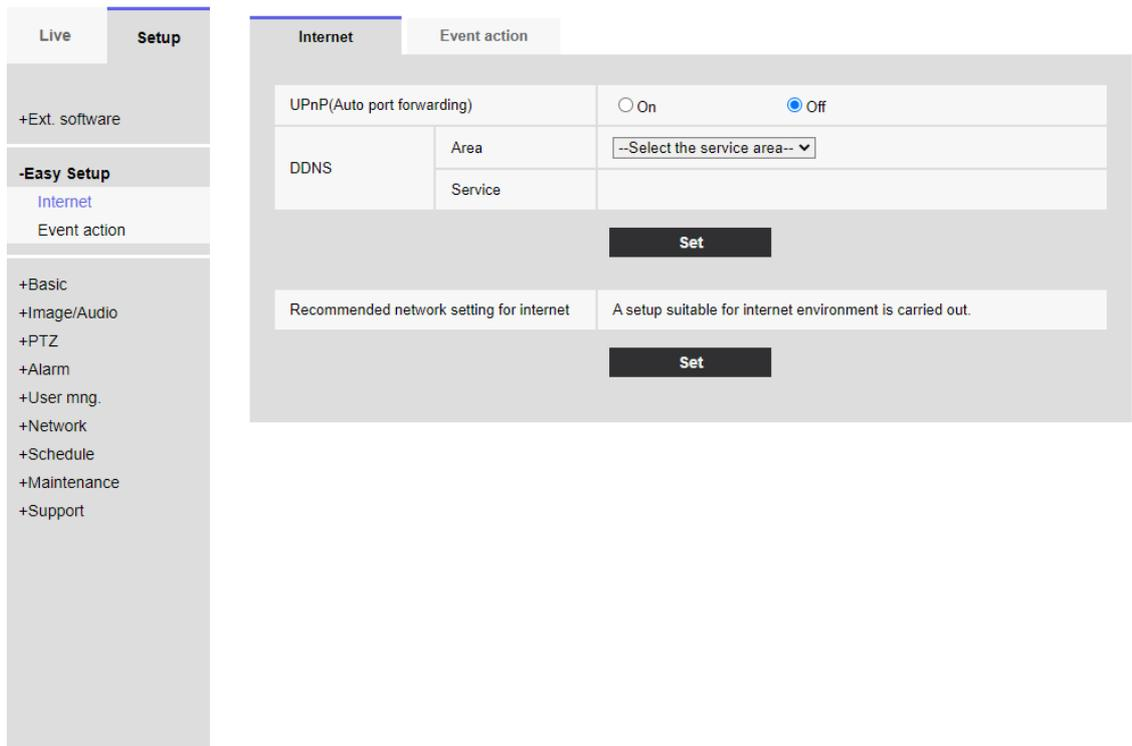

5.2 How to operate

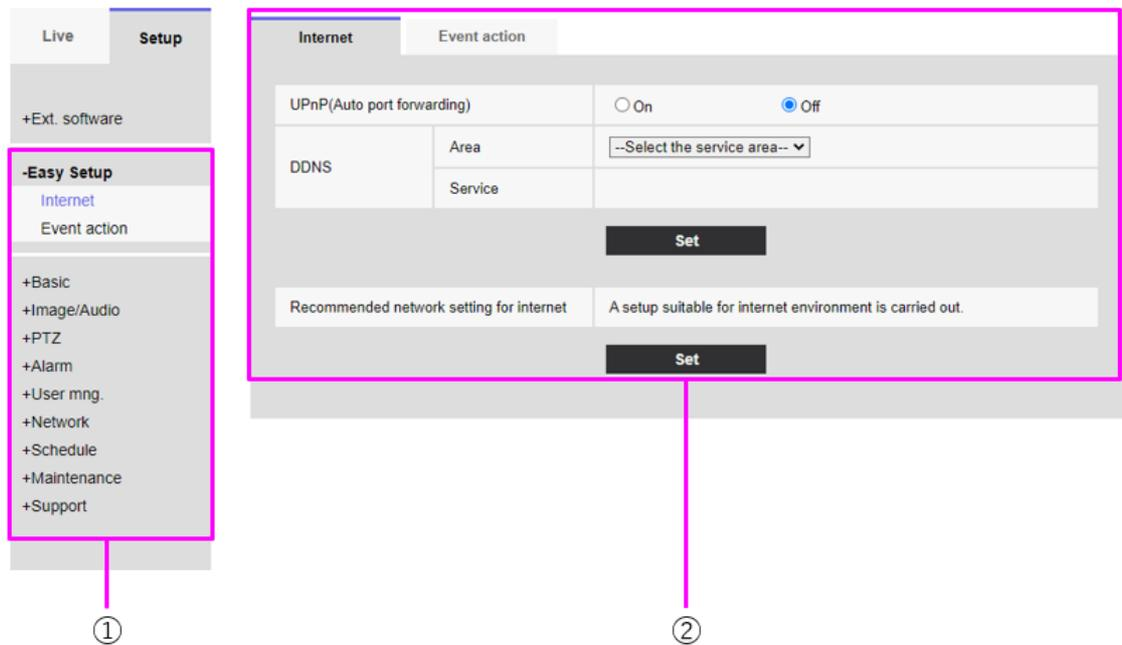

① Menu button

② Configuration page

- 1 Click the menu button on the left side of the screen to display the setting page.
If the page consists of more than one tab, click on each tab.
- 2 Enter each item on the setting page.
- 3 Once the entry is complete, confirm the entry by clicking [Set].



[Important]

• If there are several buttons in the [Set], [Register], and [Execute] pages, click the [Set], [Register], and [Execute] buttons for each item.

<example>

| | | |
|------------------------------------------|---------|---------------------------------------------------------------|
| Internet | | Event action |
| UPnP(Auto port forwarding) | | <input type="radio"/> On <input checked="" type="radio"/> Off |
| DDNS | Area | --Select the service area-- |
| | Service | |
| | | Set |
| Recommended network setting for internet | | A setup suitable for internet environment is carried out. |
| | | Set |

When you have finished setting the items in field A, click [Set] (A-1) below field A.

If you do not press the [Set] button (A-1) at the bottom of field A, the setting will not be confirmed.

As above, when you have finished setting the items in Box B, click [Set] (B-1) below Box B.

5.3 Camera Advanced Menu Screen

Fixed cameras

5 Displaying the camera settings menu from the PC
 5.3 Camera Advanced Menu Screen

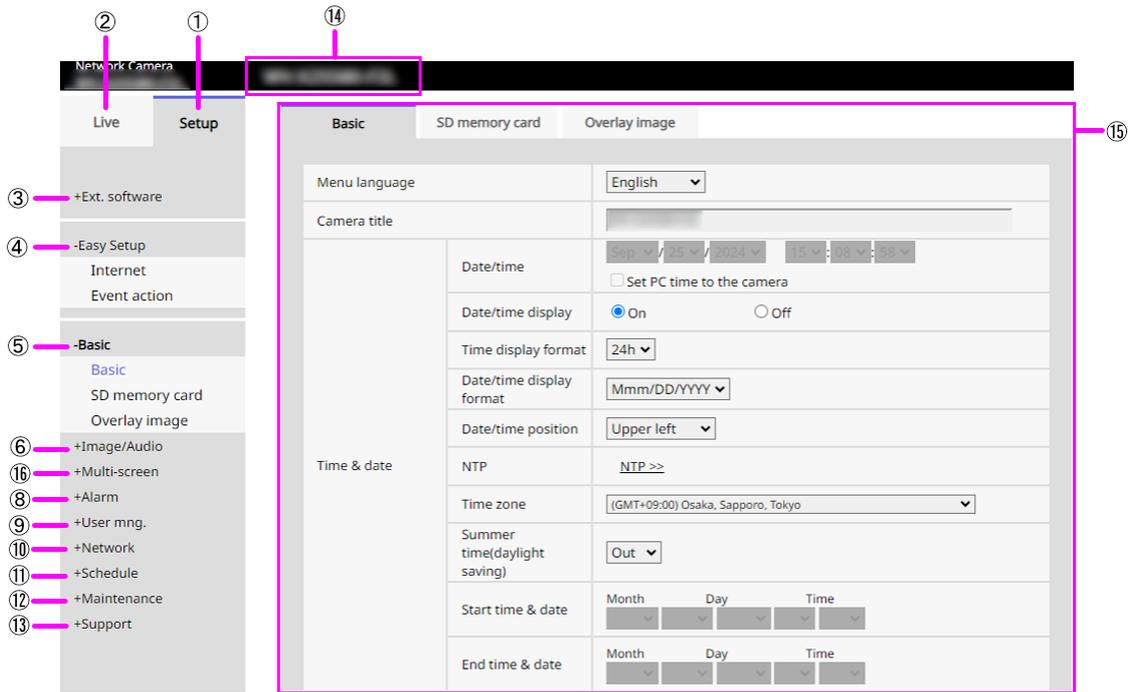

PTZ camera

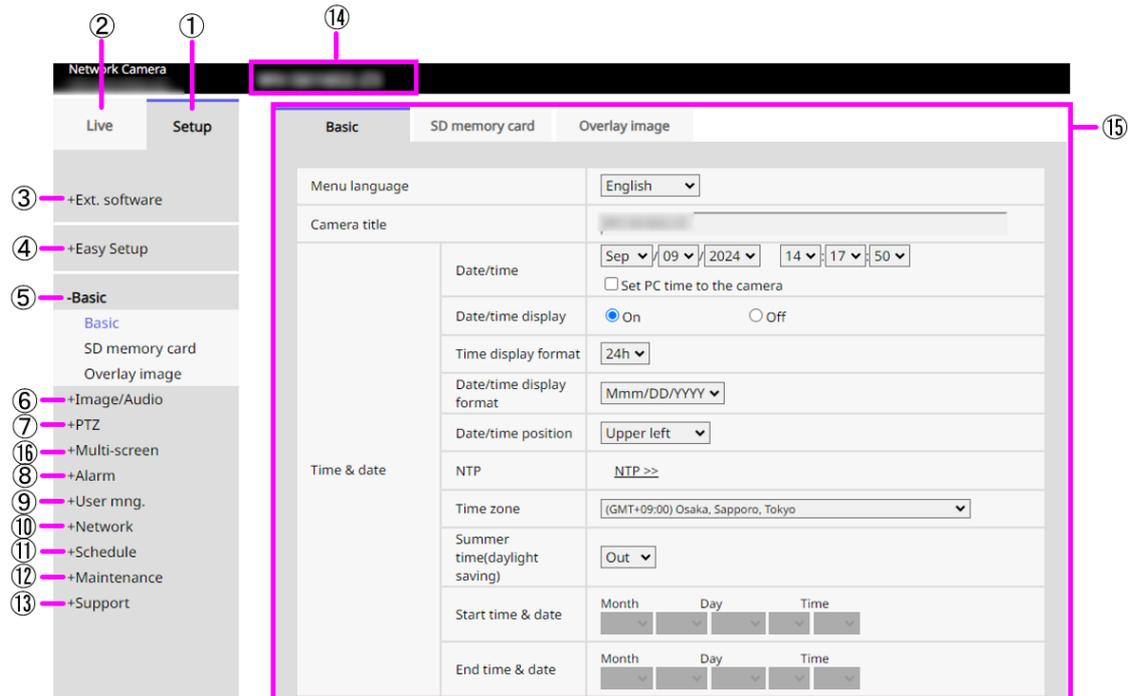

Multi-directional camera

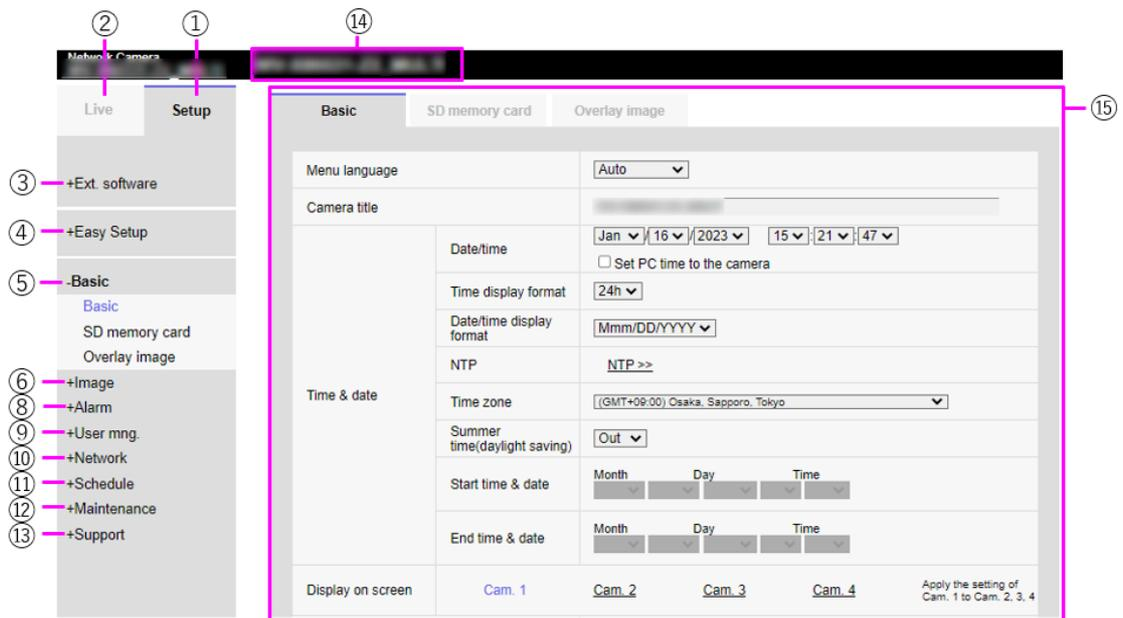

① [Setup] buttons

Indicates the setup menu.

② [Live] buttons

Live image pages are displayed.

③ [Ext. software] buttons

You can manage the function extension software and set schedules. When the function extension software is installed, a link to the screen is displayed.

→6 [\[Ext. software\] for managing and scheduling advanced software](#)

④ [Easy Setup] buttons

Displays the easy setting page. On the easy setting page, the event operation such as Internet disclosure setting, alarm setting and alarm linkage operation are set.

→7 [\[Easy Setup\] to use easy setting](#)

⑤ [Basic] buttons

Displays the basic page. Basic pages set basic settings such as date and time, camera title, and information about the SD Memory Card.

→8 [\[Basic\] for basic setup of the machine](#)

⑥ [Image/Audio] buttons

Video/audio pages are displayed. Image/Audio pages configure camera settings such as image quality and resolution for JPEG/H.265/H.264 images.

→9 [\[Image/Audio\] for setting images and sound files](#)

⑦ [PTZ] buttons

Displays the PTZ page. On the PTZ page, settings are made for the home position and camera operations such as self-return.

→10 [Set PTZ](#)

⑧ **[Alarm] buttons**

Alarm page is displayed. On the alarm page, the alarm operation and operation detection area are set, the disturbance detection area is set, the sound detection alarm is set, the impact detection alarm is set, the opening detection alarm is set, and the alarm notification is set.

→12 [\[Alarm\] to set the alarm](#)

⑨ **[User mng.] buttons**

Displays the User Administration page. The User Management page is used to register authentication and configure data encryption to restrict users and PCs accessing the computer.

→13 [\[User mng.\] to set authentication](#)

⑩ **[Network] buttons**

Displays the network page. The network pages configure the network settings for your computer and the settings for DDNS (Dynamic DNS), SNMP (Simple Network Management Protocol), FTP/SFTP, NTP servers, UPnP, HTTPS, QoS, SRTP, MQTT and LLDP.

→14 [Networking configuration \[Network\]](#)

⑪ **[Schedule] buttons**

Schedule page is displayed. In the Schedule page, the schedule is set for operation detection permission, disturbance detection permission, sound detection permission, impact detection permission, opening detection permission, etc.

→15 [\[Schedule\] for scheduling](#)

⑫ **[Maintenance] buttons**

Displays the maintenance page. On the Maintenance page, you can check the system log, upgrade the software version, check the status, and initialize the settings of the computer.

→16 [\[Maintenance\] to maintain the machine](#)

⑬ **[Support] buttons**

The Support page is displayed. The support pages show how to display our support websites.

→17 [Viewing Our Support Website \[Support\]](#)

⑭ **[Camera title]**

Displays the currently set camera title.

⑮ **[Settings page]**

Displays the page of each setting menu. Depending on the menu, some pages may have more than one tab. The lower part of the setting page is omitted.

⑯ **[Multi-screen] buttons**

Multi-screen page is displayed. on the Multi-screen page, the cameras from which images are to be displayed on a multi-screen can be registered.

6 [Ext. software] for managing and scheduling advanced software

The function extension software page manages the function extension software and sets the operation schedule. The Enhanced Software page consists of the [Software mng.], [Operation sched.], and [Control log] tabs.



[Note:]

- The items that can be set differ depending on the function of the model.
- Refer to the catalog specifications for the functions installed in each model.
- If the imaging modes are [16:9 mode(60fps mode)]/[16:9 mode(50fps mode)]/[4:3 mode(15fps mode)]/[4:3 mode(12.5fps mode)], the function extension software cannot be used. The operation schedule of the function extension software during installation is also deleted.
- Depending on the type of extension software, it may be limited to up to 7.5 fps in 15 fps mode, up to 6.25 fps in 12.5 fps mode, up to 15 fps in 30 fps mode, and up to 12.5 fps in 25 fps mode.
- [New X Fixed] There is a limit to the combined use of Extension software that can be used concurrently.

Extension software pairing is available on the support website.(Control No.:C0103)

For use in Japan:

https://i-pro.com/products_and_solutions/ja/surveillance/learning-and-support/knowledge-base/technical-information

For use outside Japan:

<https://i-pro.com/global/en/surveillance/training-support/support/technical-information>

6.1 [Software mng.] for installing, uninstalling, and upgrading function extension software

On the Extension software pages, select the [Software mng.] tabs. Please refer to the following instructions for how to display and operate the Advanced menu.

6 [Ext. software] for managing and scheduling advanced software

6.1 [Software mng.] for installing, uninstalling, and upgrading function extension software

→5.1 How to display

→5.2 How to operate



[Note:]

- The factors displayed differ depending on the function of the model.
- Refer to the catalog specifications for the functions installed in each model.

Rapid PTZ Cameras, Multi-directional + PTZ (PTZ part), Compact Dome cameras, Corner cameras

The screenshot shows a web interface for software management. At the top, there are three tabs: 'Software mng.', 'Operation sched.', and 'Control log'. The 'Software mng.' tab is active, displaying a table of system information:

| Unique information | |
|-----------------------------|---------------------------------------------------------------|
| MPR ID | 0000-0100-0000-0007 |
| Remaining ROM | 20480 Kbytes |
| Remaining RAM | 122880 Kbytes |
| SDK version | 1.00 |
| Firmware version | 2018 |
| RAM capacity expansion mode | <input type="radio"/> On <input checked="" type="radio"/> Off |

Below the table is a 'Set' button. Underneath, there are several notes and links:

- When "On" is set for the RAM capacity expansion mode, the function to record on the SD memory card will become unavailable.
- "Off" is unavailable when the remaining RAM capacity is less than 51200 Kbytes.
- Refer to the following URL for extension software required to set "On" for the RAM capacity expansion mode.

For use in Japan: <https://cwc.i-pro.com/pages/application-platform-list>
For use in a country other than Japan: <https://i-pro.com/global/en/surveillance/i-pro-application-platform/application-list>

Below this, there is another table for AI-VMD settings:

| | |
|------------------|-----------------------------------------------|
| AI-VMD | <input type="button" value="Uninstall"/> |
| Software version | 1.00 |
| Status | Operable |
| Setup menu | <input type="button" value="Setup >>"/> |

At the bottom, there is a file selection dialog box with the following options:

- Install new Ext. software (with an 'Execute' button)
- AI-VMD... Upgrade

Below the dialog, there is a message: 'Use the latest edition of the extension software.' and another message: 'Please wait and do not operate the browser during install.'

At the very bottom, there is a section for 'AI Processor Activation Key' with a text input field and a 'Set' button. A note below it says: '*No dashes in between.'

new X fixed camera

6 [Ext. software] for managing and scheduling advanced software

6.1 [Software mng.] for installing, uninstalling, and upgrading function extension software

Software mng. Operation sched. Control log

| Unique information | |
|--------------------|-------------------------|
| MPR ID | 72886-81986-01204-0100F |
| Remaining ROM | 4607780 bytes |
| Remaining RAM | 4607784 bytes |
| SDK version | 1.00 |
| Firmware version | 2.10 |

There are restrictions on the combination of extension software that can be used simultaneously.
Enhancement software combinations are listed on the support website. (Control No.: C0103)
Note: Internet connection required to view this page.

- For use in Japan
https://i-pro.com/products_and_solutions/ja/surveillance/learning-and-support/knowledge-base/technical-information
- For use in a country other than Japan
<https://i-pro.com/global/en/surveillance/training-support/support/technical-information>

Choose File No file chosen

Install new Ext. software **Execute**

Use the latest edition of the extension software.

Please wait and do not operate the browser during install.

| | |
|-------------------------------|------------|
| AI Processor Activation Key | |
| Register the Registration Key | Registered |

Multi-directional camera

6 [Ext. software] for managing and scheduling advanced software

6.1 [Software mng.] for installing, uninstalling, and upgrading function extension software

The screenshot displays a software management interface with three tabs: "Software mng.", "Operation sched.", and "Control log". The "Software mng." tab is active, showing a table of unique information and a list of AI-VMD units for four cameras. Below the list is an installation dialog box with the following content:

| Unique information | |
|--------------------|----------------------|
| MPR ID | 12700-0100-0000-0070 |
| Remaining ROM | 100000/100000 |
| Remaining RAM | 4000/100000 |
| SDK version | 1.00 |
| Firmware version | 2018 |

| | |
|------------------|-----------------------|
| AI-VMD(Cam. 1) | Uninstall |
| Software version | 2.00000001.00 |
| Status | Operable |
| Setup menu | Setup >> |
| AI-VMD(Cam. 2) | Uninstall |
| Software version | 2.00000001.00 |
| Status | Operable |
| Setup menu | Setup >> |
| AI-VMD(Cam. 3) | Uninstall |
| Software version | 2.00000001.00 |
| Status | Operable |
| Setup menu | Setup >> |
| AI-VMD(Cam. 4) | Uninstall |
| Software version | 2.00000001.00 |
| Status | Operable |
| Setup menu | Setup >> |

Choose File | No file chosen

Install new Ext. software **Execute**

Cam: 1 ▾

AI-VMD(Cam. 1)...Upgrade

AI-VMD(Cam. 2)...Upgrade

AI-VMD(Cam. 3)...Upgrade

AI-VMD(Cam. 4)...Upgrade

Use the latest edition of the extension software.

Please wait and do not operate the browser during install.

| | |
|-------------------------------|------------|
| AI Processor Activation Key | |
| Register the Registration Key | Registered |

Install the function extension software

- 1 Save the function extension software to be installed on the PC.



[Important]

- Check the [Remaining ROM] [Remaining RAM].

If there is insufficient space required to install the function extension software, uninstall the installed function extension software.

See [Uninstall] for uninstallation.

- 2 Specify the [Ext. software] by clicking [Select Files].
- 3 Use [Camera selection] to select the cameras where you want to install Extension software. When Quad/Dual mode is selected, [Camera selection] items are not displayed.



[Note:]

- [MULTI] [Camera selection] can be selected only for Multi-directional cameras.

- 4 Make sure that [Install new Ext. software] is selected and press [Execute]. [Ext. software] is installed. When the installation is completed, the name of the function extension software installed on the [Software mng.] window is added.



[Important]

- Do not use spaces or double-byte characters in the name of the destination directory.
- Use the specified file (ext file) for Extension software.
- Do not turn off the camera during installation.
- Do not perform any operation during installation until the installation is completed.
- Extension software is installed only on the selected cameras.
- [MULTI] If Image capture mode is switched to Quad/Dual mode or from Quad/Dual mode to another mode, all Extension software is uninstalled. Re-install if necessary.

Software Management Screen

When the function extension software is installed, the camera-specific data and the registration status of the function extension software are displayed. The following operations can be performed on this screen.

- Uninstalling the function extension software
- Display of the detailed registration status screen
- Display of the setting screen of the function extension software
- Update of the function extension software

**[Note:]**

- Refer to the catalog specifications for the maximum number of software extensions that can be installed.
- For the functional extension software we sell and provide, please refer to our technical information website<Control No. C0103>.

Camera-specific data**[MPR ID]**

This ID is required to issue the license cancellation key number of the function extension software. The device has a unique device ID.

[Remaining ROM]

Displays the ROM capacity for the function extension software remaining in the camera. If the function extension software to be installed requires more than the ROM capacity shown here, it cannot be installed.

[Remaining RAM]

Displays the RAM capacity for the function extension software remaining in the camera. If the function extension software to be installed requires more RAM capacity than shown here, it cannot be installed.

The ROM capacity and RAM capacity depend on the model you use.

| Model name | ROM capacity | RAM capacity |
|-----------------------------------------------------------------------------------------------------------------------------------------------------------|--------------|--------------|
| Multi-directional cameras | 150MB | 200MB |
| Rapid PTZ Camera(X/S Series, Image capture size: 2MP), Multi-directional + PTZ (PTZ part), and Compact Dome cameras (X/S series, Image capture size: 2MP) | 100MB | 100MB |
| Rapid PTZ cameras (X/S series, Image capture size: 8M (4K)), Rapid PTZ Camera(X/S Series, Image capture size: 6MP), Indoor PTZ cameras and Corner cameras | 150MB | 250MB |
| Compact Dome cameras (X/S series, Image capture size: 4MP) | 100MB | 50MB |
| New X Fixed Cameras | 6GB | 450MB |

[SDK version]

This displays the version information of the SDK installed in the camera. If the function extension software to be installed requires more than the version number displayed here, the function

extension software may not work properly.

[Firmware version]

The camera software version information is displayed.

[RAM capacity expansion mode]

Use [On]/[Off] to set whether to expand the RAM capacity.



[Note:]

- [RAM capacity expansion mode] can be selected only for models with RAM capacity extension. For models with RAM capacity extensions [FAQ](#) Refer to "Software installation conditions for the i-PRO camera".
- When [RAM capacity expansion mode] is set to [On], the recording function of the this product function on the SD Memory Card is disabled.
- If [Remaining RAM] shows negative values, uninstall Extension software or set [RAM capacity expansion mode] to [On].
- Clicking [Set] restarts this product. After restarting, the product cannot be operated for about two minutes as it was when the power was turned on.
- Information about Extension software that requires [RAM capacity expansion mode] to be set to [On] can be found on our website.

For use in Japan:

<https://cwc.i-pro.com/pages/application-platform-list>

For use outside Japan:

<https://i-pro.com/global/en/surveillance/i-pro-application-platform/application-list>

Extension software

[Function Extension Software Name]

The installed function extension software is displayed in the list. If the camera is installed separately, it is displayed as [Name of Function Extension Software (Camera Number)].



[Note:]

- [MULTI] Only the Multi-directional camera displays the camera number.

[Uninstall] buttons

You can uninstall the installed function extension software.

[Software version]

When function extension software is installed, the version information of the installed function

extension software and the version information of the SDK incorporated in the function extension software are displayed. If the version number of the SDK included in the camera is less than the version number required by the function extension software, the function extension software may not work properly.



[Note:]

- If the function extension software does not include the SDK version information, the SDK version information is not displayed.

[Status]

Displays the installation status of the function extension software. When [Operable] is displayed, it indicates that the installed function extension software is ready for operation.

[Setup] buttons

When the function extension software has its own screen, such as the setting screen, the screen can be displayed.

Install new extended software

Select this to install the new function extension software. Select the camera to be installed and the function extension software to be installed.



[Note:]

- [MULTI] Only a Multi-directional camera can be installed.

Upgrade the version

Select the function extension software that is already installed. You can upgrade the function extension software by clicking [Execute].

AI processor deactivation license

You can install and use the application software released from other companies using the AI processor on your computer.

About Managing Extension software with Platform Expansion Modules

Combined with a service for a particular service provider, Extension software can be managed on a cloud or other server.

For details, contact your service provider.

To develop Extension software for these services, see the portal site (<https://dev-partner.i-pro.com/>). An account is required for browsing.



[Note:]

- [New X Fixed-8M] When managed from a cloud or other server, 30fps mode is limited to the maximum 12.5fps at the maximum 15fps, 25fps mode, regardless of the configured frame rate.
- [New X Fixed] When managed from a cloud or other server, all Extension software installed on the camcorder will be stopped.

6.2 [Operation sched.] for scheduling extended software

On the Extension software pages, select the [Operation schedule] tabs. Refer to the table below for how to display and operate the setting menu.

→5.1 [How to display](#)

→5.2 [How to operate](#)

New X Fixed Camera

- 6 [Ext. software] for managing and scheduling advanced software
- 6.2 [Operation sched.] for scheduling extended software

Software mng.
Operation sched.
Control log

▼
Apply the setting of Monday to all days of the week

| Operating day of week | Mon | Tue | Wed | Thu | Fri | Sat | Sun |
|-----------------------|-----------------------|-----------------------|-----------------------|-----------------------|-----------------------|-----------------------|-----------------------|
| Day | <input type="radio"/> | <input type="radio"/> | <input type="radio"/> | <input type="radio"/> | <input type="radio"/> | <input type="radio"/> | <input type="radio"/> |
| Time table 1 | <input type="radio"/> | <input type="radio"/> | <input type="radio"/> | <input type="radio"/> | <input type="radio"/> | <input type="radio"/> | <input type="radio"/> |
| Time table 2 | <input type="radio"/> | <input type="radio"/> | <input type="radio"/> | <input type="radio"/> | <input type="radio"/> | <input type="radio"/> | <input type="radio"/> |
| Off | <input type="radio"/> | <input type="radio"/> | <input type="radio"/> | <input type="radio"/> | <input type="radio"/> | <input type="radio"/> | <input type="radio"/> |

[Time table 1]

| | | | | | 0:00 | 6:00 | 12:00 | 18:00 | 24:00 | Operation content |
|---|----|----|---|----|------|------|-------|-------|-------|-------------------|
| 1 | 00 | 00 | - | 00 | 00 | | | | | Off |
| 2 | 00 | 00 | - | 00 | 00 | | | | | Off |
| 3 | 00 | 00 | - | 00 | 00 | | | | | Off |
| 4 | 00 | 00 | - | 00 | 00 | | | | | Off |
| 5 | 00 | 00 | - | 00 | 00 | | | | | Off |
| 6 | 00 | 00 | - | 00 | 00 | | | | | Off |

[Time table 2]

| | | | | | 0:00 | 6:00 | 12:00 | 18:00 | 24:00 | Operation content |
|---|----|----|---|----|------|------|-------|-------|-------|-------------------|
| 1 | 00 | 00 | - | 00 | 00 | | | | | Off |
| 2 | 00 | 00 | - | 00 | 00 | | | | | Off |
| 3 | 00 | 00 | - | 00 | 00 | | | | | Off |
| 4 | 00 | 00 | - | 00 | 00 | | | | | Off |
| 5 | 00 | 00 | - | 00 | 00 | | | | | Off |
| 6 | 00 | 00 | - | 00 | 00 | | | | | Off |

Set

Multisensor Camera, PTZ Camera, Compact Dome camera, Corner cameras

- 6 [Ext. software] for managing and scheduling advanced software
- 6.2 [Operation sched.] for scheduling extended software

Software mng.
Operation sched.
Control log

AI-VMD ▾

Operating day of week

| Day | Mon | Tue | Wed | Thu | Fri | Sat | Sun |
|--------------|----------------------------------|----------------------------------|----------------------------------|----------------------------------|----------------------------------|----------------------------------|----------------------------------|
| Time table 1 | <input checked="" type="radio"/> | <input checked="" type="radio"/> | <input checked="" type="radio"/> | <input checked="" type="radio"/> | <input checked="" type="radio"/> | <input checked="" type="radio"/> | <input checked="" type="radio"/> |
| Time table 2 | <input type="radio"/> | <input type="radio"/> | <input type="radio"/> | <input type="radio"/> | <input type="radio"/> | <input type="radio"/> | <input type="radio"/> |
| Off | <input type="radio"/> | <input type="radio"/> | <input type="radio"/> | <input type="radio"/> | <input type="radio"/> | <input type="radio"/> | <input type="radio"/> |

[Time table 1]

| | | 0:00 | 6:00 | 12:00 | 18:00 | 24:00 | Operation content |
|---|-----------------------------------------------------------------------------------------------------------------------------------------------|------|------|-------|-------|-------|-------------------|
| 1 | <input type="text" value="00"/> ▾ : <input type="text" value="00"/> ▾ - <input type="text" value="00"/> ▾ : <input type="text" value="00"/> ▾ | | | | | | Off ▾ |
| 2 | <input type="text" value="00"/> ▾ : <input type="text" value="00"/> ▾ - <input type="text" value="00"/> ▾ : <input type="text" value="00"/> ▾ | | | | | | Off ▾ |
| 3 | <input type="text" value="00"/> ▾ : <input type="text" value="00"/> ▾ - <input type="text" value="00"/> ▾ : <input type="text" value="00"/> ▾ | | | | | | Off ▾ |
| 4 | <input type="text" value="00"/> ▾ : <input type="text" value="00"/> ▾ - <input type="text" value="00"/> ▾ : <input type="text" value="00"/> ▾ | | | | | | Off ▾ |
| 5 | <input type="text" value="00"/> ▾ : <input type="text" value="00"/> ▾ - <input type="text" value="00"/> ▾ : <input type="text" value="00"/> ▾ | | | | | | Off ▾ |
| 6 | <input type="text" value="00"/> ▾ : <input type="text" value="00"/> ▾ - <input type="text" value="00"/> ▾ : <input type="text" value="00"/> ▾ | | | | | | Off ▾ |

[Time table 2]

| | | 0:00 | 6:00 | 12:00 | 18:00 | 24:00 | Operation content |
|---|-----------------------------------------------------------------------------------------------------------------------------------------------|------|------|-------|-------|-------|-------------------|
| 1 | <input type="text" value="00"/> ▾ : <input type="text" value="00"/> ▾ - <input type="text" value="00"/> ▾ : <input type="text" value="00"/> ▾ | | | | | | Off ▾ |
| 2 | <input type="text" value="00"/> ▾ : <input type="text" value="00"/> ▾ - <input type="text" value="00"/> ▾ : <input type="text" value="00"/> ▾ | | | | | | Off ▾ |
| 3 | <input type="text" value="00"/> ▾ : <input type="text" value="00"/> ▾ - <input type="text" value="00"/> ▾ : <input type="text" value="00"/> ▾ | | | | | | Off ▾ |
| 4 | <input type="text" value="00"/> ▾ : <input type="text" value="00"/> ▾ - <input type="text" value="00"/> ▾ : <input type="text" value="00"/> ▾ | | | | | | Off ▾ |
| 5 | <input type="text" value="00"/> ▾ : <input type="text" value="00"/> ▾ - <input type="text" value="00"/> ▾ : <input type="text" value="00"/> ▾ | | | | | | Off ▾ |
| 6 | <input type="text" value="00"/> ▾ : <input type="text" value="00"/> ▾ - <input type="text" value="00"/> ▾ : <input type="text" value="00"/> ▾ | | | | | | Off ▾ |

Set

Select the function extension software to set the operation schedule.

[Operating day of week]

Select [Time table 1] [Time table 2] [Off] for each day of the week.

[Apply the setting of Monday to all days of the week]

When Box is enabled and [Set] is pressed, the setting of Monday is reflected in all days of the week.

[Time table 1] [Time table 2]

To specify the time, click [▼] to set the time. 24-hour setting is available for [00:00] to [00:00].

You can configure [On]/[Off] in [Operation content].

How to set the schedule

- 1 From the list of function extension software, select the software for which the operation

6 [Ext. software] for managing and scheduling advanced software

6.3 [Control log] to check the [Control log] of the function extension software

schedule is to be set.

- 2 In the [Operating day of week], select the day of the week and the timetable that you want to schedule.
- 3 In [Time table 1] [Time table 2], specify the time zone to be operated.
Specify [00:00] to [00:00] for 24-hour operation.
- 4 When you are finished, press [Set].

6.3 [Control log] to check the [Control log] of the function extension software

Displays the administration logs for Extension software. Refer to the table below for how to display and operate the setting menu.

→5.1 [How to display](#)

→5.2 [How to operate](#)

Up to 200 management logs can be saved in the internal memory of the computer.

If the maximum number of management logs that can be saved is exceeded, the log is overwritten from the old log.

100 management logs are displayed and saved even if the camera is turned off.

| Software mng. | Operation sched. | Control log |
|-----------------|------------------|-------------|
| 1/2Page | | |
| << Previous 100 | | |
| Next 100 >> | | |
| No. | Time & date | Description |

[Next 100 items>>]

Click to display the following 100 entries in the management log list that you are viewing.

[Page number display]

The currently open page is displayed in the form [Page/Total Page].

[<<Previous 100 items]

Click to display 100 items in front of the displayed management log list.

[No]

6 [Ext. software] for managing and scheduling advanced software

6.3 [Control log] to check the [Control log] of the function extension software

The serial number in the control log is displayed.

[Time & date]

The date and time when the log occurred is displayed.

[Description]

The contents of the management log are displayed.

For the contents of each control log, please refer to our technical information website.<Control number: C0317>

7 [Easy Setup] to use easy setting

The following settings can be made on the easy setting page.

- Publish camera images on the Internet
- Sets event operation such as recording to SD Memory Card by schedule/alarm.

The easy configuration pages consist of the [Easy installation], [Internet], and [Event action] tabs.



[Note:]

- The items that can be set differ depending on the function of the model.
- Refer to the catalog specifications for the functions installed in each model.

7.1 [Easy installation] where easy installation is performed



[Note:]

- Dual mode is not supported.
- For how to adjust the camera orientation and angle, refer to the "Operation Manual Installation".
- To automatically adjust the camera, set the vertical (TILT) angle of the camera to 80 degrees.

When the [Easy installation] tabs on the easy setting pages are clicked, the instructions for setting the cameras are displayed.

- 1 Select the method in which the camera is installed.

7 [Easy Setup] to use easy setting

7.1 [Easy installation] where easy installation is performed

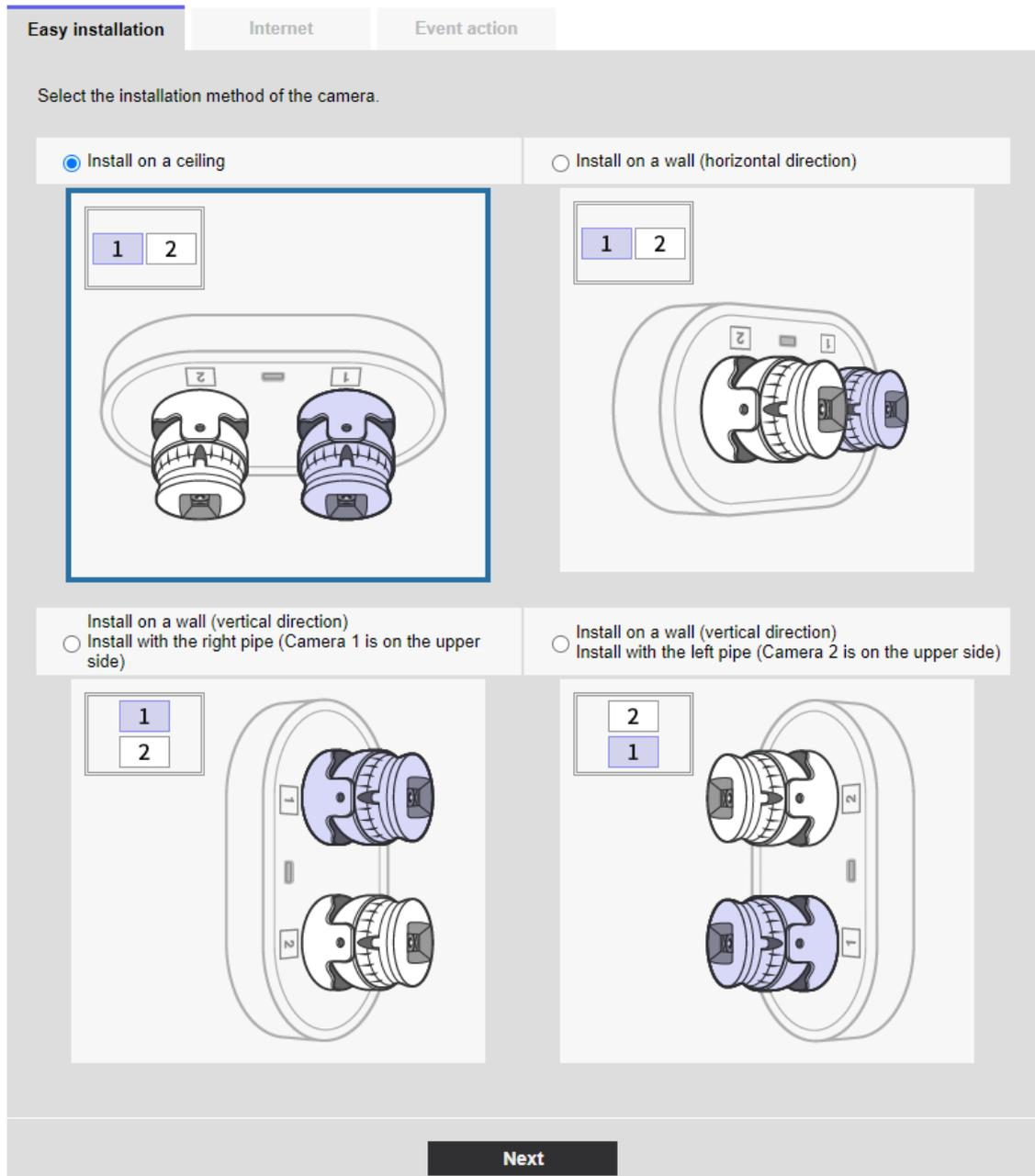

[Install on a ceiling]:

Select this when the camera is placed on the ceiling.

[Install on a wall (horizontal direction)]:

Select this when the camera is placed horizontally on the wall.

[Install on a wall (vertical direction) Install with the right pipe (Camera 1 is on the upper side)]:

Select this if the camera is installed vertically on a wall with Camera 1 facing up.

[Install on a wall (vertical direction) Install with the left pipe (Camera 2 is on the upper side)]:

Select this if the camera is installed vertically on a wall with Camera 2 facing up.

[Next]Button:

Go to the next display.

2 Check the actual display. Fine-tune the screen as required.

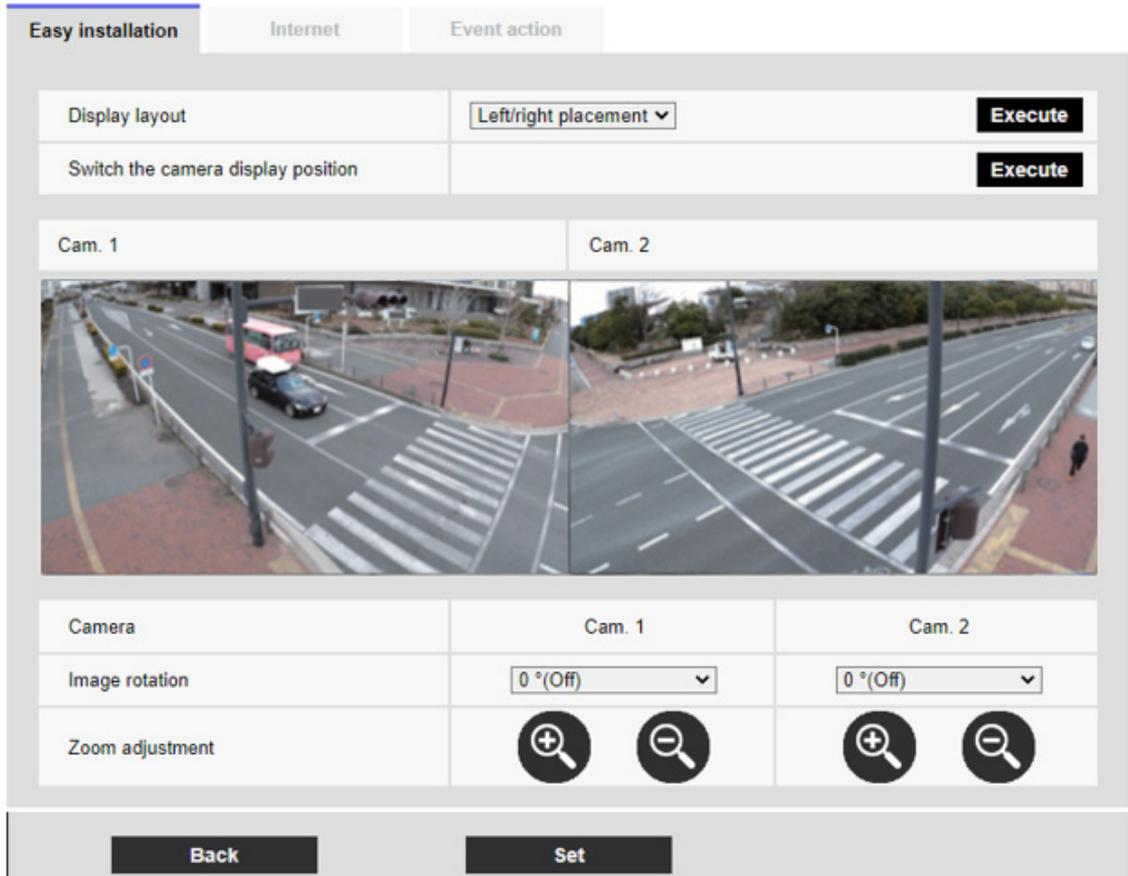

[Display Layout]:

The image display position can be specified.

[Left/right placement]: The screen will be left-to-right.

[Up/down placement]: The screen is positioned up and down.

Press [Execute] to refresh the window in the selected alignment.

[Switch the camera display position]:

Press [Execute] to change the displayed window.

[Image rotation]:

Rotate the displayed image.

[Zoom adjustment]:

Zoom is adjusted.

[Back]Button:

Go back to a previous screen.

[Set]Button:

Confirms made selections.

7.2 [Internet] to set up an Internet-based disclosure system

Click the [Internet] tab for easy setting. Refer to the table below for how to display and operate the setting menu.

→5.1 [How to display](#)

→5.2 [How to operate](#)

This is to configure the UPnP (Automatic Port Forwarding), DDNS, and Internet Recommendation settings that are required to publish the camera on the Internet.

[UPnP(Auto port forwarding)]

You can configure [On]/[Off] to use the router's port forwarding capability.

To use the Automatic Port Forwarding feature, the router you use must be UPnP-enabled and UPnP enabled.



[Note:]

- Automatic port forwarding may change the port number. If this is changed, the port number of the camera registered on the PC or recorder must be changed.
- The UPnP feature can be used to connect a camera to an IPv4 network. IPv6 is not supported.
- To verify that auto-port forwarding has been configured correctly, click on the [Status] tab on the Maintenance page and make sure that the [UPnP] status is [On].
→16.3 [\[Status\] for checking the status](#)
If [On] is not displayed, please read [Cannot access cameras from internet] in "Trouble!?"
→18.2 [Trouble!?](#)
- If you change the [UPnP(Auto port forwarding)] settings, the [UPnP] on the [Advanced] tabs of the network pages will also change.
- If the live screen or configuration screen is not displayed correctly, such as when replacing the routers to be used, set [UPnP(Auto port forwarding)] to [Off] once and then set it to [On] again.

[Area]

Select the region where the camera is installed.

[Global]/[Japan]



[Note:]

- Select [Japan] when using cameras in Japan. The [Viewnetcam.com] services displayed when [Global] is selected are not accessible from within Japan.
- [Indoor PTZ] [Viewnetcam.com] service does not appear even if you select [Global].

[Service]

Select [Viewnetcam.com]/[Off] to use the [Viewnetcam.com] services in the DDNS. After you set up the Net, click [Go to MIEMASUNET Registration page] to open the Register [Viewnetcam.com] Services window in the new window. After that, proceed with the registration according to the screen.

For more information, see [With [Viewnetcam.com] services] or the [Viewnetcam.com] website (<http://www.viewnetcam.com/>).

→ 14.4.1 With [Viewnetcam.com] services



[Note:]

- If you change the [DDNS] settings, the [DDNS] on the [Advanced] tabs of the network pages will also change.

[Recommended network setting for internet]

Set the recommended settings for publishing the camera on the Internet. When [Set] is clicked, the dialog box displays the changes in the settings for the following settings: Click OK after checking.

Compact Dome cameras (X/S series, Image capture size: 4MP)

[Image] tabs for video and audio pages

• [JPEG(1)]

[Image capture size]: QVGA/ 320x180

• [Stream(1)] • [Stream(2)] • [Stream(3)]

[Delivery mode]: best effort delivery

[Frame rate]: 30 fps

[Max bit rate (per client) *]: 1024 kbps

• [Stream(1)]

[Image capture size]: 2560x1920/2560x1440

• [Stream(2)]

[Image capture size]: VGA/ 640x360

• [Stream(3)]

[Image capture size] :VGA/ 640x360

[Network] tabs on network pages

- [IPv6/v4 Common]

[Maximum RTP packet size]: Limited (1280 bytes)

[HTTP max segment size(MSS)]: Restricted (1280 bytes)

Compact Dome cameras (X/S series, Image capture size: 2MP),New X Fixed Cameras(Image capture size: 2MP)

[Image] tabs for video and audio pages

- [JPEG(1)]

[Image capture size]:QVGA/ 320x180

- [Stream(1)]

[Delivery mode]: best effort delivery

[Frame rate]: 30/ 25 fps(When [Image capture mode] is [(60/ 50 fps)] mode: 60/ 50 fps)

[Max bit rate (per client) *] :1024 kbps

- [Stream(2)] • [Stream(3)] • [Stream(4)]

[Delivery mode: best effort delivery

[Frame rate]: 30 fps(When [Image capture mode] is [(60/ 50 fps)] mode: 10/ 8.3 fps)

[Max bit rate (per client) *] :1024 kbps

- [Stream(1)]

[Image capture size] :1280x960/ 1280x720

- [Stream(2)]

[Image capture size] :VGA/ 640x360

- [Stream(3)]

[Image capture size] :VGA/ 640x360

- [Stream(4)]

[Image capture size] :QVGA/ 320x180

[Network] tabs on network pages

- [IPv6/v4 Common]

[Maximum RTP packet size: Limited (1280 bytes)

[HTTP max segment size(MSS)]: Restricted (1280 bytes)

Compact Dome cameras (U series, Image capture size: 4MP)

[Image] tabs for video and audio pages

- [JPEG(1)]

[Image capture size]:QVGA/ 320x180 (When [Image capture mode] is [16:9(30/ 25fps) 2688x1520] mode: 640x360)

- [Stream(1)]

[Delivery mode]: best effort delivery

[Frame rate]: When [Image capture mode] is [4:3 mode(30fps mode)]/ [16:9 mode(30fps mode)]: 30fps

When [Image capture mode] is [4:3 mode(25fps mode)]/ [16:9 mode(25fps mode)]: 25fps

When [Image capture mode] is [4:3 mode(15fps mode)]: 15fps

When [Image capture mode] is [4:3 mode(12.5fps mode)]: 12.5fps

[Max bit rate (per client) *]: 1024 kbps

•[Stream(2)] • [Stream(3)]

[Delivery mode]: best effort delivery

[Frame rate]: When [Image capture mode] is [4:3 mode(30fps mode)]/ [16:9 mode(30fps mode)]: 30fps

When [Image capture mode] is [4:3 mode(25fps mode)]/ [16:9 mode(25fps mode)]: 25fps

When [Image capture mode] is [4:3 mode(15fps mode)]: 15fps

When [Image capture mode] is [4:3 mode(12.5fps mode)]: 12.5fps

When [Image capture mode] is [16:9 mode(2688x1520 30fps mode)]: Off

When [Image capture mode] is [16:9 mode(2688x1520 25fps mode)]: Off

[Max bit rate (per client) *]: 1024 kbps

•[Stream(1)]

[Image capture size]:1280x960 (When [Image capture mode] is [4:3(15/ 12.5fps)] mode: 2048x1536)/ 1920x1080

•[Stream(2)]

[Image capture size] :VGA/ 640x360

•[Stream(3)]

[Image capture size] :QVGA/ 320x180

[Network] tabs on network pages

•[IPv6/v4 Common]

[Maximum RTP packet size]: Limited (1280 bytes)

[HTTP max segment size(MSS)]: Restricted (1280 bytes)

Compact Dome cameras (U series, Image capture size: 2MP)

[Image] tabs for video and audio pages

•[JPEG(1)]

[Image capture size]:QVGA/ 320x180

•[Stream(1)] • [Stream(2)]

[Delivery mode]: best effort delivery

[Frame rate]: When [Image capture mode] is [4:3 mode(30fps mode)]/ [16:9 mode(30fps mode)]: 30fps

When [Image capture mode] is [4:3 mode(25fps mode)]/ [16:9 mode(25fps mode)]: 25fps

[Max bit rate (per client) *] :1024 kbps

•[Stream(3)] • [Stream(4)]

[Delivery mode]: best effort delivery

[Frame rate]: When [Image capture mode] is [4:3 mode(30fps mode)]: 30fps

When [Image capture mode] is [4:3 mode(25fps mode)]: 25fps

When [Image capture mode] is [16:9 mode(30fps mode)]: 5fps

When [Image capture mode] is [16:9 mode(25fps mode)]: 6.25fps

[Max bit rate (per client) *] :1024 kbps

•[Stream(1)]

[Image capture size]:1280x960/ 1280x720

•[Stream(2)]

[Image capture size] :VGA/ 640x360

•[Stream(3)]

[Image capture size] :QVGA/ 320x180

•[Stream(4)]

[Image capture size] :QVGA/ 320x180

[Network] tabs on network pages

•[IPv6/v4 Common]

[Maximum RTP packet size]: Limited (1280 bytes)

[HTTP max segment size(MSS)]: Restricted (1280 bytes)

New X Fixed Cameras(Image capture size: 8MP,Image capture size: 6MP,Image capture size: 5MP)

[Image] tabs for video and audio pages

•[JPEG(1)]

[Image capture size]:2560x1440

•[JPEG(2)]

[Image capture size]:640x360

•[Stream(1)]

[Delivery mode]: best effort delivery

[Frame rate]: 5/ 4.2 fps(When [Image capture mode] is [(60/ 50 fps)] mode: 60/ 50 fps)

[Max bit rate (per client) *] :1024 kbps

- [Stream(2)] • [Stream(3)] • [Stream(4)]

[Delivery mode]: best effort delivery

[Frame rate]: 15/ 12.5 fps(When [Image capture mode] is [(60/ 50 fps)] mode: Off)

[Max bit rate (per client) *] :1024 kbps

- [Stream(1)]

[Image capture size]:2560x1440

- [Stream(2)] • [Stream(3)]

[Image capture size] :640x360

- [Stream(4)]

[Image capture size] :320x180

[Network] tabs on network pages

- [IPv6/v4 Common]

[Maximum RTP packet size]: Limited (1280 bytes)

[HTTP max segment size(MSS)]: Restricted (1280 bytes)

Corner cameras

[Image] tabs for video and audio pages

- [JPEG(1)]

[Image capture size]:QVGA/ 320x180

- [Stream(1)]

[Delivery mode]: best effort delivery

[Frame rate]: When [Image capture mode] is [4:3 mode(30fps mode)]/ [16:9 mode(30fps mode)]: 5fps

When [Image capture mode] is [4:3 mode(25fps mode)]/ [16:9 mode(25fps mode)]: 4.2fps

[Max bit rate (per client) *] :1024 kbps

- [Stream(2)] • [Stream(3)] • [Stream(4)]

[Delivery mode]: best effort delivery

[Frame rate]: When [Image capture mode] is [4:3 mode(30fps mode)]/ [16:9 mode(30fps mode)]: 15fps

When [Image capture mode] is [4:3 mode(25fps mode)]/ [16:9 mode(25fps mode)]: 12.5fps

[Max bit rate (per client) *] :1024 kbps

- [Stream(1)]

[Image capture size]:2560x1920/ 2560x1440

- [Stream(2)]

[Image capture size] :VGA/ 640x360

- [Stream(3)]

[Image capture size] :VGA/ 640x360

- [Stream(4)]

[Image capture size] :QVGA/ 320x180

[Network] tabs on network pages

- [IPv6/v4 Common]

[Maximum RTP packet size]: Limited (1280 bytes)

[HTTP max segment size(MSS)]: Restricted (1280 bytes)

Rapid PTZ Cameras (X/S Series, Image capture size: 2MP), Multi-directional + PTZ (PTZ part)

[Image] tabs for video and audio pages

- [JPEG(1)]

[Image capture size]:QVGA/ 320x180

- [Stream(1)]

[Delivery mode]: best effort delivery

[Frame rate]: When [Image capture mode] is [4:3 mode(15fps mode)]: 15fps

When [Image capture mode] is [4:3 mode(12.5fps mode)]: 12.5fps

When [Image capture mode] is [4:3 mode(30fps mode)]/ [16:9 mode(30fps mode)]: 30fps

When [Image capture mode] is [4:3 mode(25fps mode)]/ [16:9 mode(25fps mode)]: 25fps

When [Image capture mode] is [16:9 mode(60fps mode)]: 60fps fixed

When [Image capture mode] is [16:9 mode(50fps mode)]: 50fps fixed

[Max bit rate (per client) *]: 1024 kbps

- [Stream(2)] • [Stream(3)] • [Stream(4)]

[Delivery mode]: best effort delivery

[Frame rate]: When [Image capture mode] is [4:3 mode(15fps mode)]: 15fps

When [Image capture mode] is [4:3 mode(12.5fps mode)]: 12.5fps

When [Image capture mode] is [4:3 mode(30fps mode)]/ [16:9 mode(30fps mode)]: 30fps

When [Image capture mode] is [4:3 mode(25fps mode)]/ [16:9 mode(25fps mode)]: 25fps

When [Image capture mode] is [16:9 mode(60fps mode)]: 10fps

When [Image capture mode] is [16:9 mode(50fps mode)]: 8.3fps

[Max bit rate (per client) *]: 1024 kbps

- [Stream(1)]

[Image capture size]:1280x960/ 1280x720

- [Stream(2)]

[Image capture size] :VGA/ 640x360

- [Stream(3)]

[Image capture size] :VGA/ 640x360

- [Stream(4)]

[Image capture size] :QVGA/ 320x180

[Network] tabs on network pages

- [IPv6/v4 Common]

[Maximum RTP packet size]: Limited (1280 bytes)

[HTTP max segment size(MSS)]: Restricted (1280 bytes)

Rapid PTZ Cameras (X/S series, Image capture size: 8M (4K)), Indoor PTZ cameras (Image capture size: 8M (4K)), Image capture size: 6MP)

[Image] tabs for video and audio pages

- [JPEG(1)]

[Image capture size]:320x180

- [Stream(1)]

[Delivery mode]: best effort delivery

[Frame rate]: When [Image capture mode] is [16:9 mode(30fps mode)]: 5fps

When [Image capture mode] is [16:9 mode(25fps mode)]: 4.2fps

[Max bit rate (per client) *]: 1024 kbps

- [Stream(2)] • [Stream(3)] • [Stream(4)]

[Delivery mode]: best effort delivery

[Frame rate]: When [Image capture mode] is [16:9 mode(30fps mode)]: 15fps

When [Image capture mode] is [16:9 mode(25fps mode)]: 12.5fps

[Max bit rate (per client) *]: 1024 kbps

- [Stream(1)]

[Image capture size] :2560x1440

- [Stream(2)]

[Image capture size] :640x360

- [Stream(3)]

[Image capture size] :640x360

- [Stream(4)]

[Image capture size] :320x180

[Network] tabs on network pages

- [IPv6/v4 Common]

[Maximum RTP packet size]: Limited (1280 bytes)

[HTTP max segment size(MSS)]: Restricted (1280 bytes)

Multi-directional camera

[Image] tabs for video and audio pages

- [JPEG]

[Image capture size : 320 x 180 (when Image capture mode is not in Quad/Dual mode)/640 x 360 (when Image capture mode is in Quad/Dual mode)

- [Stream(1)] • [Stream(2)]

[Delivery mode]: best effort delivery

[Frame rate]: When [Image capture mode] is [5 megapixels [4:3](15fps mode)]/ [5 megapixels [16:9](15fps mode)]: 15fps

When [Image capture mode] is [5 megapixels [4:3](12.5fps mode)]/ [5 megapixels [16:9](12.5fps mode)]: 12.5fps

When [Image capture mode] is [5 megapixels [4:3](15fps Quad mode)]/ [5 megapixels [16:9](15fps Quad mode)]: 15fps

When [Image capture mode] is [5 megapixels [4:3](12.5fps Quad mode)]/ [5 megapixels [16:9](12.5fps Quad mode)]: 12.5fps

[Max bit rate (per client) *]: 1024 kbps

- [Stream(1)]

[Image capture size] :2560x1440

- [Stream (2)]

[Image capture size] :640x360

[Network] tabs on network pages

- [IPv6/v4 Common]

[Maximum RTP packet size: Limited (1280 bytes)

[HTTP max segment size(MSS)]: Restricted (1280 bytes)

7.3 [Event action] for setting events

Select the [Event action] tabs on the easy setting pages. Refer to the table below for how to display and operate the setting menu.

→5.1 [How to display](#)

→5.2 [How to operate](#)

Here, the contents of the current setting are displayed.

| Internet | Event action |
|---------------------------------------------------------------------------------------------------------------------------------------------------|--------------|
| Configure the event action setting. Specify the action to be taken when an alarm is detected and register the action in the schedule in order. | |
| [Current settings] | |
| Alarm | |
| Alarm condition | Off |
| Alarm | Off |
| Output terminal | Off |
| E-mail notification | Off |
| Schedule | |
| Schedule | Off |
| [Notes] • When the operating condition is changed, some settings will be cancelled. Confirm the settings after completing the setup. | |
| <div style="background-color: black; color: white; padding: 5px 20px; display: inline-block;">Next</div> | |

In event operation, the event operation can be set for SD schedule recording, regular transmission of FTP/SFTP, and alarm detection. When the settings are complete, press [Next] to proceed. The configuration flow is as follows.



[Note:]

- [FTP/SFTP periodic image transmission] can be selected only for models with FTP/SFTP features.
- Refer to the catalog specifications for the functions installed in each model.
- Clicking [Next] saves the settings in the window.

Event operation flow

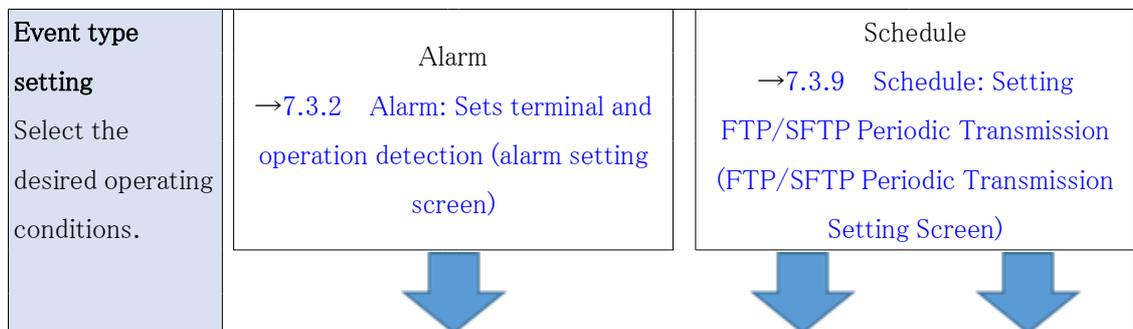



[Note:]

- [MULTI] There is no FTP/SFTP function.

7.3.1 Schedule/alarm setting (event type setting screen)

Here, select the type of event.

| | |
|--------------------------------------------------------------------------------------------------------------------------------|--------------|
| Internet | Event action |
| Select an event that triggers the event action. When it is needed to format the SD memory card, click the [Execute] button. | |
| Trigger | Alarm ▼ |
| SD memory card format | Execute |
| Next | |

[Trigger]

[Alarm]:Select this to set the alarm detection.

[Schedule] :[Select this when you want to [FTP/SFTP periodic image transmission] SD-Record.



[Note:]

- [FTP/SFTP periodic image transmission] can be selected only for models with FTP/SFTP features.
- Refer to the catalog specifications for the functions installed in each model.

[SD memory card format]

To format the SD Memory Card, press [Execute].

Clicking [Execute] displays the [Format] confirmation window.

Press the [OK] button to start formatting.

When the [Format] Completion window is displayed, press x.



[Important]

- When formatting is performed, all data stored on the SD Memory Card are deleted.
- Do not turn off the computer during formatting.

[Next] buttons

Select [Alarm] and press [Next] to open the Alarm Settings window.

→7.3.2 Alarm: Sets terminal and operation detection (alarm setting screen)

Select [Schedule] and press [Next] to open the Schedule Type Settings window.

→7.3.7 Schedule: Set SD recording or FTP/SFTP periodic transmission (Schedule type setting screen)

7.3.2 Alarm: Sets terminal and operation detection (alarm setting screen)

This section sets the operation when an alarm is detected.

The screenshot shows the 'Event action' configuration screen for an alarm. It includes a title bar with 'Internet' and 'Event action' tabs. Below the title bar is a set of instructions: 'Set the alarm condition to be used for the alarm detection. The whole area except the preset positions is to be set as the detection area for the motion detection alarm. The motion detection area for each preset position can be set by configuring the settings for "VMD area" of "Alarm". To move the camera to the preset position when an alarm is detected, configure the settings for "Alarm linkage action". For SCD alarm, set all areas as the detection area.'

| Alarm | |
|-------------------------|---------------------------------------------------------------|
| Terminal 1 | Off |
| Terminal 2 | Off |
| Terminal 3 | Off |
| VMD alarm | <input type="radio"/> On <input checked="" type="radio"/> Off |
| SCD alarm | <input type="radio"/> On <input checked="" type="radio"/> Off |
| Audio detection alarm | <input type="radio"/> On <input checked="" type="radio"/> Off |
| Alarm deactivation time | 5 s (0.5s,1-600s) |

| Camera action on alarm | |
|------------------------|-----|
| Terminal alarm 1 | Off |
| Terminal alarm 2 | Off |
| Terminal alarm 3 | Off |
| VMD alarm | Off |
| SCD alarm | Off |
| Audio detection alarm | Off |

At the bottom of the screen are two buttons: 'Back' and 'Next'.

Corner cameras

Internet
Event action

Configure the alarm condition to be used for the alarm detection.
 The whole area of area 1 is to be set as the detection area for the motion detection alarm.
 The whole area is to be set as the detection area for SCD alarm.

| Alarm | |
|-----------------------------|---------------------------------------------------------------|
| Terminal 1 | Off ▼ |
| Terminal 2 | Off ▼ |
| Terminal 3 | Off ▼ |
| VMD alarm | <input type="radio"/> On <input checked="" type="radio"/> Off |
| SCD alarm | <input type="radio"/> On <input checked="" type="radio"/> Off |
| Audio detection alarm | <input type="radio"/> On <input checked="" type="radio"/> Off |
| Impact detection alarm | <input type="radio"/> On <input checked="" type="radio"/> Off |
| Casing open detection alarm | <input type="radio"/> On <input checked="" type="radio"/> Off |
| Alarm deactivation time | 5 s (0.5s,1-600s) |

Alarm

[Terminal 1]

Set the operation of terminal 1.

- **[Off]**: Terminal function is not used.
- **[Alarm input(TRM1)]**: Terminal alarm input is received.
 - **[Close]**: When the terminal status changes to [On], an alarm is detected.
 - **[Open]**: When the terminal status changes to [Off], an alarm is detected.
 - **[Close(Continue)]**: When the terminal status changes to [On], an alarm is detected. When the terminal status is [On], the alarm is detected periodically at intervals of no alarm detection time.
 - **[Open(Continue)]**: When the terminal status changes to [Off], an alarm is detected. When the terminal status is [Off], the alarm is detected periodically at intervals of no alarm detection time.
- **[Black & white input]**: Receives black-and-white selector input. (When the input is [On], the input is switched to black and white)
- **[Auto time adjustment]**: Time setting by terminal input is accepted. When the signal is input, set to 00 minutes 00 seconds if the time difference from the normal time (00 minutes per hour) is 29 minutes or less. In the case of returning the time less than 5 seconds during SD recording, the time is not changed. Selecting Auto Time Adjustment displays the pull-down menu for short

circuit and release selection.

- [Close]:When the terminal status changes to [Close], the automatic time adjustment is performed.
- [Open]:When the terminal status changes to [Open], the automatic time adjustment is performed.

[Terminal 2]

Set the operation of terminal 2.

- [Off]:Terminal function is not used.
- [Alarm input (TRM2)]:The alarm input is received.
- [Short circuit]:When the terminal status changes to [On], an alarm is detected.
- [Open]:When the terminal status changes to [Off], an alarm is detected.
- [Short circuit (Continued)]:When the terminal status changes to [On], an alarm is detected.

When the terminal status is [On], the alarm is detected periodically at intervals of no alarm detection time.

- [Open (continued)]:When the terminal status changes to [Off], an alarm is detected. When the terminal status is [Off], the alarm is detected periodically at intervals of no alarm detection time.
- [Alarm Output]:Alarm outputs according to the setting in [Output terminal].

→[12.2 \[Alarm\] for setting the output terminal](#)

[Terminal 3]

Set the operation of terminal 3.

- [Off]:Terminal function is not used.
- [Alarm input (TRM3)]:The alarm input is received.
- [Short circuit]:When the terminal status changes to [On], an alarm is detected.
- [Open]:When the terminal status changes to [Off], an alarm is detected.
- [Short circuit (Continued)]:When the terminal status changes to [On], an alarm is detected.

When the terminal status is [On], the alarm is detected periodically at intervals of no alarm detection time.

- [Open (continued)]:When the terminal status changes to [Off], an alarm is detected. When the terminal status is [Off], the alarm is detected periodically at intervals of no alarm detection time.
- [Aux output]:AUX output is performed. The [AUX] buttons appear on the live picture pages.

[VMD alarm]

On:If the motion detection area is not set, the entire area is set. To set the operation detection area, use the [VMD area] tab on the alarm page.

→[12.6 \[VMD area\] to set the motion detection area](#)

[Off]:Disables all operation detection status.

[Scene change detection (SCD) alarm]

[On]:If the disturbance detection area is not set, the entire area is set. To set up the undesired detection area, use the [SCD area] tab on the alarm page.

→[12.7 \[SCD area\] to set up undesired detection](#)

[Off]:Disables all disturbance detection conditions.

[Audio detection alarm]

[On]:Use the sound detection alarm. All AI sounds are recognized.

→[12.9 \[Audio detection\] for setting sound detection](#)

[Off]:Sound detection alarm is not used.

[Impact detection alarm]

[On]:Use the impact detection alarm. Impact detection is recognized.

→[12.10 \[Impact detection\] for setting impact detection](#)

[Off]:Impact detection alarm is not used.

[Casing open detection alarm]

[On]:Use the opening detection alarm. Opening detection is recognized.

→[12.11 \[Casing open detection\] for setting opening detection](#)

[Off]:Opening detection alarm is not used.

[Alarm deactivation time]

Sets the time when the alarm is detected and the detection operation is not executed. For example, if you set up an e-mail notification to a mobile terminal or a tablet terminal using an alarm, this setting prevents you from sending too much e-mail.

5-[600 seconds]



[Note:]

- Alarm detection time is managed for each alarm type. For example, the operation detection alarm is detected even when the alarm of terminal alarm 1 is not detected.

Alarm linkage operation

[Terminal alarm 1]

Select the action to be interlocked when terminal alarm 1 is detected from the following. This can be set when [Terminal 1] of the alarm is set to [Alarm input(TRM1)].

[Off]:Interlock operation is not performed even if terminal alarm 1 is detected.

1~256:When the preset position registered in advance is selected, the watch moves to the preset position when terminal alarm 1 is detected.

[Patrol 1]:When terminal alarm 1 is detected, patrol starts.

*When Patrol 1 is not registered, it is not displayed.

[Terminal alarm 2]

Select the action to be interlocked when terminal alarm 2 is detected from the following. This can be set when [Terminal 2] of the alarm is set to [Alarm input(TRM2)].

[Off]:Interlock operation is not performed even if terminal alarm 2 is detected.

1~256:When the preset position registered in advance is selected, it moves to the position when terminal alarm 2 is detected.

[Patrol 2]:When terminal alarm 2 is detected, patrol starts.

*When Patrol 2 is not registered, it is not displayed.

[Terminal alarm 3]

Select the action to interlock when terminal alarm 3 is detected from the following. This can be set when [Terminal 3] of the alarm is set to [Alarm input(TRM3)].

[Off]:Interlock operation is not performed even if terminal alarm 3 is detected.

1~256:Select the preset position registered beforehand to move to the position when terminal alarm 3 is detected.

[Patrol 3]:When terminal alarm 3 is detected, patrol starts.

*When Patrol 3 is not registered, it is not displayed.



[Note:]

- [PTZ] Only PTZ can be selected for [Camera action on alarm].

[VMD alarm]

Select the action to be linked to the alarm detected by the motion detector from the following.

[Off]:When an alarm is detected by the motion detector, interlock operation is not performed.

1~256:Selecting the preset position registered beforehand moves the watch to the position when an alarm is detected by the motion detector.

[Patrol 1]:When an alarm is detected by the motion detector, a patrol is started.

*When Patrol 1 is not registered, it is not displayed.

[Scene change detection (SCD) alarm]

Select the action to be interlocked when an alarm is detected by the undesired signal detection from the following.

[Off]:Interlock operation is not performed even if an alarm is detected by undesired signal detection.

1~256:When the preset position registered in advance is selected, the watch moves to the preset position when an alarm due to disturbance detection is detected.

[Patrol 1]:When an alarm is detected by the disturbance detection, a patrol is started. *When Patrol 1 is not registered, it is not displayed.

[Audio detection alarm]

Select the action to be linked to the alarm detected by the sound detection from the following.

[Off]:The product does not perform interlocked operation even if an alarm is detected by sound detection.

1~256:When the preset position registered in advance is selected, the watch moves to the preset position when an alarm is detected.

[Patrol 1]:When an alarm is detected by sound detection, patrol is started.

*When Patrol 1 is not registered, it is not displayed.

[Next] buttons

Click the [Next] button to open the Alarm type setting window.

→[7.3.1 Schedule/alarm setting \(event type setting screen\)](#)



[Note:]

•Clicking [Next] saves the settings in the window.

[Back] button

Returns to the previous screen.

7.3.3 Alarm: Sets operation condition (Alarm type setting screen)

Here, the operation to be performed when the alarm is detected is set.

| Internet | Event action |
|---------------------------------------------------------|-----------------------------|
| Select an action to be taken when an alarm is detected. | |
| Trigger | FTP/SFTP Transfer |
| Recording format | Stream(1) (H.265/1920x1080) |
| Back | Next |

[Trigger]

[FTP/SFTP Transfer]:FTP/SFTP transfers JPEG images when an alarm is generated.

[SD memory recording]:Record to SD Memory Card when an alarm is generated.



[Note:]

- [FTP/SFTP periodic image transmission] can be selected only for models with FTP/SFTP features.
- Refer to the catalog specifications for the functions installed in each model.
- [FTP/SFTP] and [[FTP/SFTP periodic image transmission]] can be operated at the same time when an alarm is generated.
- When [FTP/SFTP Transfer] and [[FTP/SFTP periodic image transmission]] are set simultaneously when an alarm is generated, [FTP/SFTP Transfer] when an alarm is generated takes precedence.

[Recording format]

When [SD memory recording] is selected in [Trigger], select the compression method for the images to be recorded from the JPEG/stream.

[Next] buttons

Select [FTP/SFTP Transfer] in [Trigger] and press [Next] to open the FTP/SFTP Transfer Settings window.

Select [SD memory recording] in [Trigger] and JPEG in [Recording format] and press [Next] to open the JPEG Record Setting window.

Select "[SD memory recording]" in "[Trigger]" and "[Recording format]" in "Streams" and press "[Next]" to open the Movie Record Setting window.

→7.3.4 Alarm: Setting details of image transfer or recording conditions



[Note:]

- Clicking [Next] saves the settings in the window.
- The alarm is not recorded on the SD memory card.

[Back] button

Returns to the previous screen.

7.3.4 Alarm: Setting details of image transfer or recording conditions

Setting FTP/SFTP transfer (FTP/SFTP transfer setting screen)

In this case, FTP/SFTP transfer when alarm is detected is set.



[Note:]

- The factors displayed differ depending on the function of the model.
- Refer to the catalog specifications for the functions installed in each model.

7 [Easy Setup] to use easy setting
 7.3 [Event action] for setting events

Internet **Event action**

Set the method of image transmission to the FTP/SFTP server when an alarm is detected.

| | | |
|-----------------------|---------------------------|---------------------------------------|
| Transmission protocol | <input type="radio"/> FTP | <input checked="" type="radio"/> SFTP |
|-----------------------|---------------------------|---------------------------------------|

Alarm setting (Server 1)

| | | |
|--------------------------|--------------------------------------------------------------------------------------------------------------------------------------------------------------------------------------------------------------------------------------------------------------------------------------------------------------------------------------------------------------------------------------------------------------------------------------------------------------------------------------|----------------------------------------------------------------|
| Alarm image transmission | <input type="radio"/> On | <input checked="" type="radio"/> Off |
| Directory name | [Redacted] | |
| File name | <input checked="" type="checkbox"/> Terminal 1 <input checked="" type="checkbox"/> Terminal 2 <input checked="" type="checkbox"/> Terminal 3 <input checked="" type="checkbox"/> VMD <input checked="" type="checkbox"/> SCD <input checked="" type="checkbox"/> Auto track <input checked="" type="checkbox"/> Audio detection <small>* For alarms by the "Ext. software", alarm images will be transmitted only by configuring the alarm image SFTP transmission.</small> | |
| FTP transmission retry | <input type="radio"/> On | <input checked="" type="radio"/> Off |
| Pre alarm | Transmission interval: [Redacted] | Maximum number of images: [Redacted] Recording duration: 0s |
| Post alarm | Transmission interval: [Redacted] | Number of images: [Redacted] Recording duration: 100s |
| Image capture size | JPEG(2) (640x360) | |

Alarm setting (Server 2)

| | | |
|--------------------------|-------------------------------------------------------------------------------------------------------------|--------------------------------------|
| Alarm image transmission | <input type="radio"/> On | <input checked="" type="radio"/> Off |
| Directory name | [Redacted] | |
| File name | <input type="checkbox"/> Terminal 1 <input type="checkbox"/> Terminal 2 <input type="checkbox"/> Terminal 3 | |

[FTP transmission retry] [Pre alarm] [Post alarm] [Image capture size] is the same as the [Alarm setting (Server 1)].

SFTP server 1 settings

| | |
|---------------------|---------------------------------------------------------------------------------------------------|
| SFTP server address | [Redacted] <small>Example of entry: 192.168.0.10</small> |
| Port number | 22 (1-65535) |
| Host key hash | SHA256: [Redacted] <small>Example of entry: dqVcdVZ/2ySO5tz/R6YR+rbW6dnap6P743uiMV0cf0</small> |
| User name | [Redacted] |
| Password | [Redacted] |

FTP Server 1 setting

| | |
|--------------------|-----------------------------------------------------------------------|
| FTP server address | [Redacted] <small>Example of entry: 192.168.0.10</small> |
| User name | [Redacted] |
| Password | [Redacted] |
| Control port | 21 (1-65535) |
| FTP mode | <input checked="" type="radio"/> Passive <input type="radio"/> Active |

SFTP server 2 settings

| | |
|---------------------|---------------------------------------------------------------------------------------------------|
| SFTP server address | [Redacted] <small>Example of entry: 192.168.0.10</small> |
| Port number | 22 (1-65535) |
| Host key hash | SHA256: [Redacted] <small>Example of entry: dqVcdVZ/2ySO5tz/R6YR+rbW6dnap6P743uiMV0cf0</small> |
| User name | [Redacted] |
| Password | [Redacted] |

FTP server 2 settings

| | |
|--------------------|-----------------------------------------------------------------------|
| FTP server address | [Redacted] <small>Example of entry: 192.168.0.10</small> |
| User name | [Redacted] |
| Password | [Redacted] |
| Control port | 21 (1-65535) |
| FTP mode | <input checked="" type="radio"/> Passive <input type="radio"/> Active |

For details on how to set up the above screen, refer to the following.

→[14.2.2 Configuring FTP/SFTP transmission function](#)

[Next] buttons

Select [Alarm output] in the Alarm Settings window and press [Next] to open the Alarm Outputs dialog box.

→[7.3.5 Alarm: Sets output terminal.](#)

If you do not select [Alarm output] on the Alarm Settings screen and [Next] is clicked, the Mail Settings screen is displayed.

→[7.3.6 Alarm: Configuring mail notification and mail server](#)



[Note:]

- Clicking [Next] saves the settings in the window.

[Back] button

Returns to the previous screen.

Setting SD recording (JPEG recording setting screen)

The SD recording (JPEG) for alarm detection is set here.

| Internet | Event action | |
|-------------------------------------------------------------------------------------------------------------------------------------------------------------------------------------------------------------------------|-----------------------|------------------------------|
| Configure the recording condition of the SD memory recording when an alarm is detected. Even if "Audio detection alarm" is set to "On", recording to the SD memory card will not be performed when the alarm occurs. | | |
| JPEG recording(Alarm) | | |
| File name | img_ | |
| Image saving interval/Number of images to be saved(Pre alarm) | Image saving interval | Number of images to be saved |
| | 1fps | Off |
| Image saving interval/Number of images to be saved(Post alarm) | Image saving interval | Number of images to be saved |
| | 1fps | 100 pics |
| Back | | Next |

See the [JPEG recording(Alarm)] below for instructions on how to set up the window above.

→[8.2 \[SD memory card\] for setting SD Memory Cards](#)

[Next] buttons

Select [Alarm output] in the Alarm Settings window and press [Next] to open the Alarm Outputs dialog box.

→[7.3.5 Alarm: Sets output terminal.](#)

If you do not select [Alarm output] on the Alarm Settings screen and [Next] is clicked, the Mail Settings screen is displayed.

→7.3.6 Alarm: Configuring mail notification and mail server

[Back] button

Returns to the previous screen.

Set SD recording (H.265 or H.264) (Movie recording setting screen)

Here, SD recording (H.265 or H.264) at alarm detection is set.

| Event action | |
|-------------------------------------------------------------------------------------------------------------------------------------------------------------------------------------------------------------------------|---------------------------------------------------------------|
| Configure the recording condition of the SD memory recording when an alarm is detected. Even if "Audio detection alarm" is set to "On", recording to the SD memory card will not be performed when the alarm occurs. | |
| Stream recording(Alarm) | |
| Audio recording | <input type="radio"/> On <input checked="" type="radio"/> Off |
| Frame rate* | 30fps * ▾ |
| Pre alarm (recording) duration | Off ▾ |
| Post alarm (recording) duration | 30s ▾ |

[Audio recording]

Select whether or not to record audio data with [On] or [Off].

[On]:Audio data is saved in the movie (MP4 format).

[Off]:Audio data is not saved in movies (MP4 format).



[Note:]

- If the audio distribution mode is set to bi-directional (half duplex), the settings cannot be made.

Frame Rate

Set the frame rate of H.265 (or H.264) to be recorded.



[Note:]

- Refer to the [Frame rate*] below for the frame rate you can set and the bit rate that depends on the frame rate.

→7.3.8 Schedule: Set SD recording (Movie recording setting screen)

[Pre alarm (recording) duration]

Select whether to record before alarm. Sets the time to save to the SD Memory Card.

[Off]/ [1s]/ [2s]/ [3s]/ [4s]/ [5s]/ [8s]/ [10s]/ [15s]/ [20s]/ [25s]/ [30s]/ [40s]/ [50s]/ [60s]/ [90s]/ [120s]



[Note:]

- The values that can be set depend on the resolution and bit rate of the stream to be recorded. The higher the bit rate, the smaller the maximum value that can be set as the pre-alarm time.

[Post alarm (recording) duration]

Sets the time to save to the SD Memory Card after an alarm is generated.

[10s]/ [20s]/ [30s]/ [40s]/ [50s]/ [60s]/ [120s]/ [180s]/ [240s]/ [300s]

[Next] buttons

Select [Alarm output] in the Alarm Settings window and press [Next] to open the Alarm Outputs dialog box.

→7.3.5 Alarm: Sets output terminal.

If you do not select [Alarm output] on the Alarm Settings screen and [Next] is clicked, the Mail Settings screen is displayed.

→7.3.6 Alarm: Configuring mail notification and mail server



[Note:]

- Clicking [Next] saves the settings in the window.

[Back] button

Returns to the previous screen.



[Note:]

- Refer to the catalog specifications for the functions installed in each model.

7.3.5 Alarm: Sets output terminal.

The alarm output is set here. This message is displayed when [Alarm output] is selected in the alarm setting window.

To set the output terminal:

| Internet | Event action |
|----------------------------------------------------------------------------------------------------------------------------------------------------------------------------------------------------------------------------|--------------------------------------------------------------------|
| Set the action of the output terminal when an alarm is detected. When "Latch" is selected for "Alarm output type", the alarm output is cancelled by clicking the alarm occurrence indication button in the "Live" page. | |
| Output terminal | |
| Terminal output upon alarm detection | <input type="radio"/> On <input checked="" type="radio"/> Off |
| SD memory card error | <input type="radio"/> On <input checked="" type="radio"/> Off |
| Terminal state upon alarm detection | <input checked="" type="radio"/> Latch <input type="radio"/> Pulse |
| Terminal action upon alarm detection | <input type="radio"/> Open <input checked="" type="radio"/> Close |
| Pulse output width | 1 s (1-120s) |

Back **Next**

For details of the settings on the screen above, refer to the following.

→[12.2 \[Alarm\] for setting the output terminal](#)

[Next] buttons

Click the [Next] button to display the mail setting screen.

→[7.3.6 Alarm: Configuring mail notification and mail server](#)



[Note:]

- Clicking [Next] saves the settings in the window.

[Back] button

Returns to the previous screen.

7.3.6 Alarm: Configuring mail notification and mail server

Here, the settings for mail are made.



[Note:]

- The factors displayed differ depending on the function of the model.
- Refer to the catalog specifications for the functions installed in each model.

7 [Easy Setup] to use easy setting
 7.3 [Event action] for setting events

| Internet | | Event action | |
|----------------------------------------------------------------|----------------------------------------------------------------------------------------------------------------------------------------------------------------------|---------------------------------------------------------------------------------------------------------------------------------------------------------------------------------------------------------------------------------------------------------------------------------------------------------------------------------------------------------------------------------------------------------------------------------------------------------------------------------------------------------------|--|
| Set the method of mail notification when an alarm is detected. | | | |
| E-mail notification | | | |
| E-mail notification | <input type="radio"/> On | <input checked="" type="radio"/> Off | |
| Alarm image attachment | <input type="radio"/> On | <input checked="" type="radio"/> Off | |
| Image capture size | JPG(2) (640x360) | | |
| SMTP server address | Example of entry: 192.168.0.10 | | |
| SMTP port | 25 (1-65535) | | |
| POP server address | Example of entry: 192.168.0.10 | | |
| Authentication | Type | <input checked="" type="radio"/> None <input type="radio"/> POP before SMTP <input type="radio"/> SMTP | |
| | User name | | |
| | Password | | |
| Sender's E-mail address | | | |
| SSL | <input type="radio"/> On | <input checked="" type="radio"/> Off | |
| Destination of notification | | Destination E-mail address | |
| Address 1 | | <input type="text"/> <input type="button" value="Delete"/> <input type="checkbox"/> Terminal 1 <input type="checkbox"/> Terminal 2 <input type="checkbox"/> Terminal 3 <input type="checkbox"/> VMD <input type="checkbox"/> SCD <input type="checkbox"/> Audio detection <input type="checkbox"/> Diag. <input type="checkbox"/> Auto track <small>* For alarms by the "Ext. Software", e-mail notification will be provided only by configuring the destination e-mail address setting.</small> | |
| Address 2 | | <input type="text"/> <input type="button" value="Delete"/> <input type="checkbox"/> Terminal 1 <input type="checkbox"/> Terminal 2 <input type="checkbox"/> Terminal 3 <input type="checkbox"/> VMD <input type="checkbox"/> SCD <input type="checkbox"/> Audio detection <input type="checkbox"/> Diag. <input type="checkbox"/> Auto track <small>* For alarms by the "Ext. Software", e-mail notification will be provided only by configuring the destination e-mail address setting.</small> | |
| Address 3 | | <input type="text"/> <input type="button" value="Delete"/> <input type="checkbox"/> Terminal 1 <input type="checkbox"/> Terminal 2 <input type="checkbox"/> Terminal 3 <input type="checkbox"/> VMD <input type="checkbox"/> SCD <input type="checkbox"/> Audio detection <input type="checkbox"/> Diag. <input type="checkbox"/> Auto track <small>* For alarms by the "Ext. Software", e-mail notification will be provided only by configuring the destination e-mail address setting.</small> | |
| Address 4 | | <input type="text"/> <input type="button" value="Delete"/> <input type="checkbox"/> Terminal 1 <input type="checkbox"/> Terminal 2 <input type="checkbox"/> Terminal 3 <input type="checkbox"/> VMD <input type="checkbox"/> SCD <input type="checkbox"/> Audio detection <input type="checkbox"/> Diag. <input type="checkbox"/> Auto track <small>* For alarms by the "Ext. Software", e-mail notification will be provided only by configuring the destination e-mail address setting.</small> | |
| E-mail subject(Alarm) | <input type="checkbox"/> Use the camera title <input type="checkbox"/> Cause of alarm <input type="text"/> | | |
| E-mail subject(Diag.) | <input type="checkbox"/> Use the camera title <input type="text"/> [information] | | |
| E-mail body(Alarm) | <input checked="" type="checkbox"/> Cause of alarm <input checked="" type="checkbox"/> Occurrence time The %p% alarm was occurred at %t%. <input type="text"/> | | |
| <input type="button" value="Back"/> | | <input type="button" value="Set"/> | |

For details on how to set up the above screen, refer to the following.

→[14.2.1 Set mail sending](#)

[Set] buttons

Clicking [Set] completes the setting.

[Back] button

Returns to the previous screen.

7.3.7 Schedule: Set SD recording or FTP/SFTP periodic transmission (Schedule type setting screen)

Here you set the scheduling type to [SD memory recording] or [FTP/SFTP periodic image transmission].

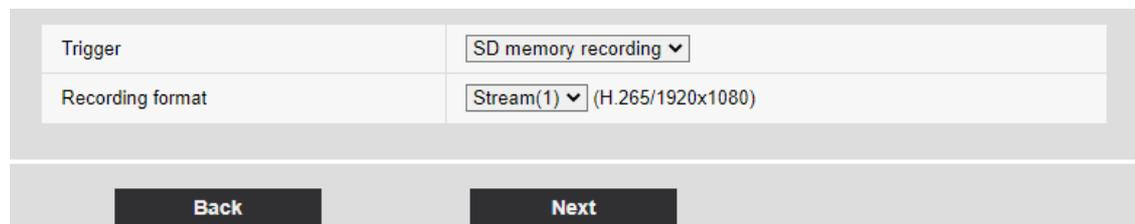

| | |
|------------------|-------------------------------|
| Trigger | SD memory recording ▼ |
| Recording format | Stream(1) ▼ (H.265/1920x1080) |

Back Next

[Trigger]

[SD memory recording]:Record H.265 (or H.264) images on the SD Memory Card at the scheduled time.

[FTP/SFTP periodic image transmission]:The JPEG image is sent to the FTP/SFTP server at the scheduled time.

[Recording format]

When [SD memory recording] is selected in [Trigger], select the streams to be recorded.

[Next] buttons

Select [SD memory recording] and press [Next] to open the Movie Record Setting window.

→[7.3.8 Schedule: Set SD recording \(Movie recording setting screen\)](#)

Select [FTP/SFTP periodic image transmission] and press [Next] to open the FTP/SFTP Periodic Transmission Settings window.

→[7.3.9 Schedule: Setting FTP/SFTP Periodic Transmission \(FTP/SFTP Periodic Transmission Setting Screen\)](#)



[Note:]

• Clicking [Next] saves the settings in the window.

[Back] button

Returns to the previous screen.



[Note:]

- The [Trigger] [FTP/SFTP periodic image transmission] can be selected only for models with FTP/SFTP features.
- Refer to the catalog specifications for the functions installed in each model.
- Both [FTP/SFTP periodic image transmission] and [FTP/SFTP] can be operated simultaneously when an alarm is generated.
- Selecting [SD memory recording] cancels the [FTP/SFTP periodic image transmission] setting.

7.3.8 Schedule: Set SD recording (Movie recording setting screen)

Here, the schedule SD recording (H.265 or H.264) is set.

When the [Next] button is clicked after recording or setting the frame rate on the movie recording setting screen, the schedule setting screen is displayed and you can set the schedule.

- 1 The recording, frame rate, and SD Memory Card are overwritten on the movie recording setting screen.

| Internet | Event action |
|---------------------------------------------------------------------------------------|---------------------------------------------------------------|
| Set the recording method of the SD memory recording to be registered in the schedule. | |
| Stream recording | |
| Audio recording | <input type="radio"/> On <input checked="" type="radio"/> Off |
| Frame rate* | 30fps * ▾ |
| Overwrite | <input checked="" type="radio"/> On <input type="radio"/> Off |
| It is not available when "50/60fps" is selected for [Image capture mode]. | |
| Back Next | |

[Audio recording]

You set whether to record audio data.

[On]: Audio data is saved in the movie (MP4 format).

[Off]: Audio data is not saved in movies (MP4 format).



[Note:]

- If the audio distribution mode is set to bi-directional (half duplex), the settings cannot be made.



[Important]

- When [Overwrite] is switched from [Off] to [On], the old images may be deleted to prepare for writing if there is not enough space on the SD Memory Card.

[Frame rate*]

Set the frame rate of H.265 (or H.264) to be recorded from the following.

-If [Image capture mode] is set to 30 fps:

1fps/ 3fps/ 5fps*/ 7.5fps*/ 10fps*/ 12fps*/ 15fps*/ 20fps*/ 30fps*

-If [Image capture mode] is set to 25fps:

1fps/ 3.1fps/ 4.2fps*/ 6.25fps*/ 8.3fps*/ 12.5fps*/ 20fps*/ 25fps*

-If [Image capture mode] is set to 15 fps:

1fps/ 3fps/ 5fps*/ 7.5fps*/ 10fps*/ 12fps*/ 15fps*

-If [Image capture mode] is set to 12.5 fps:

1fps/ 3.1fps/ 4.2fps*/ 6.25fps*/ 8.3fps*/ 12.5fps*



[Note:]

- When [Next] is clicked, [Transmission priority] is set to [Frame rate].

The bit rate is automatically set according to the selected resolution and frame rate. Check the [Bit Rate* per Client] settings for each stream.

[Overwrite]

You set whether to overwrite and save images when the free space on the SD Memory Card is running low.

[On]: If the free space on the SD Memory Card decreases, the old image is overwritten and saved repeatedly.

[Off]: If the SD Memory Card has no free space, the SD Memory Card stops storing data.



[Important]

- When [Overwrite] is switched from [Off] to [On], the old images may be deleted to prepare for writing if there is not enough space on the SD Memory Card.

[Next] buttons

Clicking [Next] displays the window for setting the recording schedule to the SD Memory Card.

[Back] button

Returns to the previous screen.

- 2 Set schedule on the Schedule Setting screen.

7 [Easy Setup] to use easy setting
 7.3 [Event action] for setting events

Internet **Event action**

Select "Recording to SD (Recording stream)" for "Schedule mode" of the schedule (1 - 8) to be registered, and set the recording schedule.
 When "Recording to SD (Recording stream)" is not select for "Schedule mode", recording will not be performed.

| Schedules | Schedule mode | Time range |
|-------------------------------------------------------|----------------------------------------------------------|------------------------------------------------------------------------------------------------------------------------------------------------------------------------------------------------------------------------------------------------------------------------------------------------------------------------------------------------------------------------------------------------------------|
| Schedule 1 (White) <input type="checkbox"/> | Off <input type="checkbox"/> On <input type="checkbox"/> | <input type="checkbox"/> Mon <input type="checkbox"/> Tue <input type="checkbox"/> Wed <input type="checkbox"/> Thu <input type="checkbox"/> Fri <input type="checkbox"/> Sat <input type="checkbox"/> Sun <input type="checkbox"/> 24h <input type="checkbox"/> : <input type="checkbox"/> : <input type="checkbox"/> - <input type="checkbox"/> : <input type="checkbox"/> : <input type="checkbox"/> |
| Schedule 2 (Blue) <input checked="" type="checkbox"/> | Off <input type="checkbox"/> On <input type="checkbox"/> | <input type="checkbox"/> Mon <input type="checkbox"/> Tue <input type="checkbox"/> Wed <input type="checkbox"/> Thu <input type="checkbox"/> Fri <input type="checkbox"/> Sat <input type="checkbox"/> Sun <input type="checkbox"/> 24h <input type="checkbox"/> : <input type="checkbox"/> : <input type="checkbox"/> - <input type="checkbox"/> : <input type="checkbox"/> : <input type="checkbox"/> |
| Schedule 3 (Green) <input type="checkbox"/> | Off <input type="checkbox"/> On <input type="checkbox"/> | <input type="checkbox"/> Mon <input type="checkbox"/> Tue <input type="checkbox"/> Wed <input type="checkbox"/> Thu <input type="checkbox"/> Fri <input type="checkbox"/> Sat <input type="checkbox"/> Sun <input type="checkbox"/> 24h <input type="checkbox"/> : <input type="checkbox"/> : <input type="checkbox"/> - <input type="checkbox"/> : <input type="checkbox"/> : <input type="checkbox"/> |
| Schedule 4 (Red) <input type="checkbox"/> | Off <input type="checkbox"/> On <input type="checkbox"/> | <input type="checkbox"/> Mon <input type="checkbox"/> Tue <input type="checkbox"/> Wed <input type="checkbox"/> Thu <input type="checkbox"/> Fri <input type="checkbox"/> Sat <input type="checkbox"/> Sun <input type="checkbox"/> 24h <input type="checkbox"/> : <input type="checkbox"/> : <input type="checkbox"/> - <input type="checkbox"/> : <input type="checkbox"/> : <input type="checkbox"/> |
| Schedule 5 (Black) <input type="checkbox"/> | Off <input type="checkbox"/> On <input type="checkbox"/> | <input type="checkbox"/> Mon <input type="checkbox"/> Tue <input type="checkbox"/> Wed <input type="checkbox"/> Thu <input type="checkbox"/> Fri <input type="checkbox"/> Sat <input type="checkbox"/> Sun <input type="checkbox"/> 24h <input type="checkbox"/> : <input type="checkbox"/> : <input type="checkbox"/> - <input type="checkbox"/> : <input type="checkbox"/> : <input type="checkbox"/> |
| Schedule 6 (Yellow) <input type="checkbox"/> | Off <input type="checkbox"/> On <input type="checkbox"/> | <input type="checkbox"/> Mon <input type="checkbox"/> Tue <input type="checkbox"/> Wed <input type="checkbox"/> Thu <input type="checkbox"/> Fri <input type="checkbox"/> Sat <input type="checkbox"/> Sun <input type="checkbox"/> 24h <input type="checkbox"/> : <input type="checkbox"/> : <input type="checkbox"/> - <input type="checkbox"/> : <input type="checkbox"/> : <input type="checkbox"/> |
| Schedule 7 (Light blue) <input type="checkbox"/> | Off <input type="checkbox"/> On <input type="checkbox"/> | <input type="checkbox"/> Mon <input type="checkbox"/> Tue <input type="checkbox"/> Wed <input type="checkbox"/> Thu <input type="checkbox"/> Fri <input type="checkbox"/> Sat <input type="checkbox"/> Sun <input type="checkbox"/> 24h <input type="checkbox"/> : <input type="checkbox"/> : <input type="checkbox"/> - <input type="checkbox"/> : <input type="checkbox"/> : <input type="checkbox"/> |
| Schedule 8 (Purple) <input type="checkbox"/> | Off <input type="checkbox"/> On <input type="checkbox"/> | <input type="checkbox"/> Mon <input type="checkbox"/> Tue <input type="checkbox"/> Wed <input type="checkbox"/> Thu <input type="checkbox"/> Fri <input type="checkbox"/> Sat <input type="checkbox"/> Sun <input type="checkbox"/> 24h <input type="checkbox"/> : <input type="checkbox"/> : <input type="checkbox"/> - <input type="checkbox"/> : <input type="checkbox"/> : <input type="checkbox"/> |

Scene settings linked to sunrise and sunset times [To scene setting \(image quality adjustment\)](#)
 When using this function, set the time zone. [Basic settings >>](#)

Auto Scheduler (Manual/ City Selection)

Latitude (-90 000000 - 90 000000)

Longitude (-180 000000 - 180 000000)

Altitude m(-500 - 5000)

Automatic calculation result
 Sunrise time :
 Sunset time :

Sunrise time and sunset time correction
 Sunrise time + Minutes (-60 - 60)
 Sunset time + Minutes (-60 - 60)
 The time of the automatic calculation result can be corrected between -60 minutes and +60 minutes.

| | 0:00 | 6:00 | 12:00 | 18:00 | 24:00 |
|-----|------|------|-------|-------|-------|
| Mon | | | | | |
| Tue | | | | | |
| Wed | | | | | |
| Thu | | | | | |
| Fri | | | | | |
| Sat | | | | | |
| Sun | | | | | |

The color of each schedule is not linked with the area color of "VMD area".
 When "VMD permission" is set, the VMD functions in all the areas set with "VMD area".
 "VMD permission", "SCD permission" and "Auto track permission" are required to be set to specify a period of time where detection or tracking is to be performed. They are not required to be set when detection or tracking is to be performed regularly.
 "Auto mode auto track" and "Auto track from the right click menu" on the "Live" page are available even when it is out of the period specified in "Auto track permission".
 If the camera direction is changed by other operation while the setting of preset position, auto pan, preset sequence or patrol is being performed, the camera will automatically move back to the previous preset position and resume the operation in 1 minute.

For details on how to set up the above screen, refer to the following.

→15 [\[Schedule\] for scheduling](#)

[Set] buttons

Clicking [Set] completes the setting.

[Back] button

Returns to the previous screen.



[Note:]

- If [SD memory recording] is not selected in [Operation mode], no recording is performed.

7.3.9 Schedule: Setting FTP/SFTP Periodic Transmission (FTP/SFTP Periodic Transmission Setting Screen)

Here, the FTP/SFTP periodic transmission is set.

When [Next] is clicked after periodic transmission and setting of servers on the periodic transmission setting screen, the periodic transmission schedule setting screen is displayed and the schedule for periodic transmission can be set.



[Note:]

- Only models with FTP/SFTP functions can be set.
- Refer to the catalog specifications for the functions installed in each model.

- 1 Settings for periodic transmission are made on the Periodic Transmission Setting screen.

- 7 [Easy Setup] to use easy setting
- 7.3 [Event action] for setting events

| Internet | | Event action | |
|-------------------------------------------------------------------------------------------------------------|---------------------------------------------------------------|------------------------------------------|--|
| Configure the FTP/SFTP server information and the method of JPEG image transmission to the FTP/SFTP server. | | | |
| Transmission protocol | <input type="radio"/> FTP | <input checked="" type="radio"/> SFTP | |
| Periodic transmission settings | | | |
| Periodic image transmission | <input type="radio"/> On | <input checked="" type="radio"/> Off | |
| Directory name | <input type="text"/> | | |
| File name | <input type="text"/> | | |
| | <input checked="" type="radio"/> Name w/time&date | <input type="radio"/> Name w/o time&date | |
| Transmission interval | 1s <input type="text"/> | | |
| Image capture size | JPEG(2) <input type="text"/> (640x360) | | |
| [Periodic image transmission] is available for [FTP Server 1], [SFTP Server 1]. | | | |
| SFTP server 1 settings | | | |
| SFTP server address | <input type="text"/> | | |
| | Example of entry: 192.168.0.10 | | |
| Port number | 22 <input type="text"/> (1-65535) | | |
| Host key hash | SHA256: <input type="text"/> | | |
| | Example of entry: dqVcdVZ/2ySO5tz/R6YR+rpbW6dnap6P743uiMV0cf0 | | |
| User name | <input type="text"/> | | |
| Password | <input type="text"/> | | |
| FTP Server 1 setting | | | |
| FTP server address | <input type="text"/> | | |
| | Example of entry: 192.168.0.10 | | |
| User name | <input type="text"/> | | |
| Password | <input type="text"/> | | |
| Control port | 21 <input type="text"/> (1-65535) | | |
| FTP mode | <input checked="" type="radio"/> Passive | <input type="radio"/> Active | |
| Back | | Set | |

For details of the settings on the screen above, refer to the following.

→ [14.2.2 Configuring FTP/SFTP transmission function](#)

[Set] buttons

Displayed when [FTP periodic image transmission] is [Off]. Clicking [Set] saves the settings.

[Next] buttons

Displayed when [FTP periodic image transmission] is [On]. Clicking [Next] displays the window for setting FTP/SFTP scheduled periodic transmissions.



[Note:]

- Clicking [Next] saves the settings in the window.

[Back] button

Returns to the previous screen.

- 2 Set the schedule for periodic transmission on the Schedule Setting screen.

For details on how to set up the above screen, refer to the following.

→15 [\[Schedule\] for scheduling](#)

[Set] buttons

Clicking [Set] completes the setting.

[Back] button

Returns to the previous screen.



[Note:]

- If [FTP/SFTP periodic image transmission] is not selected in [Operation mode], no FTP/SFTP periodic transmission is performed.

8 [Basic] for basic setup of the machine

Basic pages set the camera title, date and time, SD Memory Card, and overlay. The basic pages consist of the [Basic], [SD memory card], and [Overlay image] tabs.



[Note:]

- The layout of each setting item varies depending on the model.
- Refer to the catalog specifications for the functions installed in each model.

8.1 [Basic] to perform basic settings

On the Basic Page, press the [Basic] tab. Refer to the following how to display and operate the Advanced menu.

→5.1 [How to display](#)

→5.2 [How to operate](#)

The camera title, date, and time are set here.



[Note:]

- The layout of each setting item varies depending on the model.
- Refer to the catalog specifications for the functions installed in each model.

[Menu language]

Select the first language that appears when you access the camera from the list below.

[Auto]/[English]/[Japanese]/[Italian]/[French]/[German]/[Spanish]/[Chinese]/[Russian]/
[Portuguese]

[Auto]:The language used by the browser is automatically selected. If the machine does not support the language, the English language is selected.

[Camera title]

Enter the name of the computer. After input, press [Set] to display the entered name in the camera title.

Number of characters that can be entered:0 to 20 characters

Characters that cannot be entered:Half-pitch symbol " &

[Date/time]

Enter the current date and time. If you selected [12h] in [Time display format], select [AM] or [PM].

When [Set PC time to the camera] is checked and [Set] is clicked, the date and time of the computer are obtained and set to the camera.

Settable range: Jan/01/2013 00:00:00 ~ Dec/31/2035 23:59:59



[Important]

- If you need to set the time more accurately in system operation, use the NTP server.

→ [14.2.3 Set up an NTP server](#)

[Date/time display]

Use [On] or [Off] to set whether the date and time are displayed on the images. When the date and time are not displayed, set it to [Off].



[Note:]

- [MULTI] [Date/time display] can be set individually by the cameras.

[Time display format]

Select the time display method from 24h/12h. Enter the [Date/time] according to this setting.

[Date/time display format]

Select the date display format. If [Date/time] is set to [13:10:00 on April 1, 2022], the display formats are as follows.

DD/MM/YYYY: 01/04/2022 13:10:00

MM/DD/YYYY: 04/01/2022 13:10:00

DD/Mmm/YYYY: 01/Apr/2022 13:10:00

YYYY/MM/DD: 2022/04/01 13:10:00

Mmm/DD/YYYY: Apr/01/2022 13:10:00

[Date/time position]

Select the position where the date and time are displayed on the image.

[Upper left]: Displayed in the upper left corner of the window.

[Lower left]: Displayed in the lower left corner of the window.

[Upper center]: Displayed in the center of the window.

[Lower center]: Displayed at the bottom center of the window.

[Upper right] is displayed in the upper right corner of the window.

[Lower right]: Displayed in the lower right corner of the window.



[Note:]

- [MULTI] [Date/time position] can be set individually by the cameras.

[NTP]

Clicking [NTP >>] displays the [Advanced] tabs for the network pages.

→ [14.2.3 Set up an NTP server](#)

[Time zone]

Select the time zone for the camera area.

[Summer time(daylight saving)]

Use [In], [Out] and [Auto] to specify whether to use Daylight Saving Time. Set in the region where Daylight Saving Time is used.

[In]: Set the time to Daylight Saving Time. [*] is displayed in the time display.

[Out]: Reset Daylight Saving Time.

[Auto]: Switches to Daylight Saving Time according to the start date and time and end date settings (month, week, day of week, time).

[Start time & date] [End time & date]

When [Auto] is selected in [Summer time(daylight saving)] Setting, the start date and time of Daylight Saving Time and the end date and time of Daylight Saving Time are set in Month, Week, Day of Week, and Time.

[Display on screen]

To make individual settings, select the camera and set the settings.

Select the camera to set the following items individually for each camera.

[Date/time display]

[Date/time position]

[Camera title on screen display]

[Camera title position]



[Note:]

- [MULTI] When Image capture mode is in Quad/Dual mode, Camera 1 is automatically selected and other cameras cannot be selected.
- [MULTI] Select Camera 1 in [Display on screen] and select [Reflect all settings for Camera 1] to set the settings you changed for Camera 1 to all other cameras.

[Camera title on screen display]

Use [On]/[Off] to set whether the strings are displayed on the images.

When set to [On], the character strings entered in [Camera title on screen] are displayed at the position selected in [Position].



[Note:]

- [MULTI] [Camera title on screen display] can be set individually by the cameras.

[Camera title on screen]

Enter a character string to be displayed in the image.

Number of characters that can be entered:0 to 40 characters

Input Characters:One-byte (0-9, A-Z, a-z), two-byte (kanji, hiragana, katakana, alphanumeric), one-byte and two-byte symbols ! " # \$ % & ' () * + , - . / : ; = ?



[Note:]

- Up to two lines of [Camera title on screen] can be set.
- [MULTI] [Camera title on screen] can be set individually by the cameras.

[Camera title position]

Select the position where the character string is displayed in the image.

[Upper left]:Displays in the upper left corner of the screen.

[Lower left]:Displays in the lower left corner of the screen.

[Upper center]:Displayed in the center of the screen.

[Lower center]:Displays at the bottom center of the screen.

[Upper right]:Displayed in the upper right corner of the screen.

[Lower right]:Displays in the lower right corner of the screen.



[Note:]

- [MULTI] [Camera title position] can be set by cameras.

Date and time&In-Screen Characters > [Display type]

Sets the display format to either [Permeation] or [Opaque].

[Permeation]:Displays the date and time and characters on the screen in transparent characters.

[Opaque]:Displays date and time and on-screen characters in opaque (black-coated) characters.

Date and time&In-Screen Characters > [Character size]

Select the date and time displayed in the image and the character size of the character string.

50%:The standard 50% size is displayed.

75%:Displays the standard 75% size.

100%:Displays the standard size.

150%:This is displayed as 150% of the standard size.

200%:Displayed as 200% of standard size.



[Important]

- If the [Date/time position] and [Camera title position] settings are different, the frame rate may be lower than the set value.
- If the [Date/time position] and [Camera title position] settings are different, the characters may run out or overlap depending on the [Character size] setting and the number of characters. Confirm the display results before use.
- If [Character size] is set to [150%] or [200%], the frame rate may be lower than the set value.
- Depending on the [Character size] setting and the number of characters or the resolution of the images, it may be displayed only halfway or difficult to read. Confirm the display results before use.



[Note:]

- Even if 50% and 75% are set, the images of 640 x 360, VGA, 320 x 180, and QVGA show 100% [Camera title on screen].
- If [Detailed setting] [Overlay] is set to [On], the date and time&Characters on the Screen: You cannot set [150%] or [200%] in [Character size].

[Brightness status display]

ON/OFF is used to set whether the brightness status is displayed when adjusting the brightness.



[Note:]

- The brightness display in the image is displayed when the brightness is adjusted on the system device.

[Stabilizer]

ON/OFF is used to specify whether or not the camera's shaking correction function is enabled.

The gyroscope sensor can be used to compensate for low-frequency vibrations such as pole vibrations caused by wind and fine vibrations at high magnification, thereby shooting images with less blurring.

Use this function only when the camera is installed in an environment in which the camera

frequently swings. It is effective to reduce the vibration.

Check the operation during installation.

Do not use the shaking correction function when using the product in an environment where there is no shaking.



[Important]

- When set to [On], the field angle is narrowed. When set to [On], check the field angle when mounting the camera.
- Picture correction does not work in the following cases.
 - Pan and tilt zoom are executing.
 - During position refresh
- In the following cases, it may not be possible to obtain sufficient shaking compensation depending on the shooting conditions.
 - When the subject is dark
 - Rapid oscillation, such as mechanical vibration
 - Large-amplitude shaking
 - Image quality/position setting in progress
- If the [Stabilizer] setting is changed with the following area set, the set area will be misaligned. Set [Stabilizer] and then set the respective areas.
 - Privacy Zone
 - Operation detection area
 - Undesired detection area
 - VIQS area
 - Mask area
 - overlay image
 - Focus frame
- [New X Fixed] This function is not available when [Image capture mode] is set to [60fps Mode] or [50fps Mode].
- [New X Fixed] If you change the setting from [On] to [Off], it restarts automatically.
- [New X Fixed] When set to [On], [90°] and [270°] of [Image rotation] cannot be used.
- [New X Fixed] When set to [On], [Lens distortion compensation] cannot be used.
- [New X Fixed-2M][New X Fixed-5M] When set to [On], the zoom factor is limited to up to 3.1 times.
- [New X Fixed-8M][New X Fixed-6M] When set to [On], the zoom factor is limited to up to 2 times.



[Note:]

- When shaking occurs in a dark shooting environment, the shaking correction effect may be improved by setting the maximum exposure time to [1/100s] or faster shutter setting. Set the maximum exposure time depending on the installation environment.
- When [Stabilizer] is set to [On], the superdynamic setting is [Off].
- [PTZ]When [Stabilizer] is set to [On], the digital zoom factor is limited to half.
- Refer to the catalog specifications for the functions installed in each model.

[Image Rotation]

Select from [0° (Off)], [90°] and [180° (Upside-down)], and [270°].



[Important]

- If the [Image rotation] setting is changed with the following area set, the set area will be misaligned. Set [Image rotation] and then set the respective areas.
 - Privacy Zone
 - Operation detection area
 - Undesired detection area
 - VIQS area
 - Mask area
 - overlay image
 - Focus frame
- If [Image rotation] is set to [90°] or [270°], the on-screen characters may be broken depending on the [Character size] setting and the number of characters.
- When [Image rotation] is set to [90°] and [270°], the positions that can be set to [Date/time position] and [Camera title position] are limited to [Upper left] and [Lower left].
- [New X Fixed]When [Stabilizer] is [On] and [Image rotation] is set to [90°] or [270°] from an external device, the system automatically restarts.
- [New X Fixed]When [Image rotation] is set to [90°] or [270°], [Stabilizer] cannot be used.
- [New X Fixed]When [Image rotation] is set to [90°] or [270°] and 320x180, QVGA images are displayed, characters in the images may be cut off.



[Note:]

- Depending on the [Image capture mode], you may not be able to set the [Image Rotation] to [90°] or [270°].
- If [Image capture size] is 320 x 180, [Image rotation] cannot be set to 90° or 270° .
- [New X Fixed] Even when [Image capture size] is set to 320x180, you can set [Image rotation] to 90° or 270° .
- Refer to the catalog specifications for the functions installed in each model.

[Mirror]

Use [On]/[Off] to set whether the images are reversed left or right.



[Note:]

- If [Image rotation] is set to [90°] or [270°], the mirror inversion is fixed in [Off].

[Indicator]

Select the ON/OFF status of the lamp. To check the operation status with the lamps, select [On].



[Note:]

- Refer to the catalog specifications for the lamps installed in each model.
- [MULTI_PTZ] [Indicator] can be set from the PTZ-camera.

[FunctionLED]

Select the operation to be notified by [FunctionLED]. Multiple operations can be selected.

[REC notification]: The [FunctionLED] lights when the camera is recording video distribution or when the camera video is being distributed.

[Impact detection notification]: The [FunctionLED] indicator flashes when the camera receives an impact.

[Casing open detection notification]: When the front cover of the camera is opened, [FunctionLED] blinks.



[Note:]

- When [Impact detection notification] is selected, [FunctionLED] flashes after the camera receives an impact. The [FunctionLED] will go out one minute after the flashing starts.

- When [Casing open detection notification] is selected, [FunctionLED] flashes while the front cover is open. The [FunctionLED] will go out when the front cover is closed.
- Even if [Indicator] is set to [Off], [FunctionLED] is not turned off. To turn off the [FunctionLED], remove all the checks.

[Audio out]

Sets whether to use the audio output terminal as the adjustment monitor output.

Audio/monitor



[Note:]

- When [Audio out] is set to [Audio], [Monitor out] cannot be selected.
- If you set [Audio transmission mode] to other than [Off] or [Mic input], you cannot set [Audio out] to [Monitor].
- If you set [Audio out] to [Monitor], you cannot set [Audio transmission mode] to anything other than [Off] or [Mic input].

[Monitor out]

Set the image format to be output from the image output terminal (MONITOR OUT).

NTSC/PAL



[Note:]

- The [Monitor out] setting can be changed when the imaging mode is 30 fps, 60 fps, or 15 fps.
- [PTZ]The output image may be reversed up or down.
- [New X Fixed]The output image is rotated according to the [Image Rotation] setting.

[Tilt adjustment lever position]

Set the [Tilt adjustment lever position] set when the camera is installed.

[High]/ [Mid]/ [Low]



[Note:]

- [MULTI_PTZ] The [Tilt adjustment lever position] can only be selected for the Multi-directional camera settings.

[Privacy zone display format]

Selects the display format of Privacy Zone from [Block] and [Blurring].

Click [Privacy Zone Settings] to display the [Privacy Zone Area Settings] screen of the image quality page.

→9.4.6 [Setting the privacy zone \(Privacy zone setting screen\)](#)



[Note:]

- [New X Fixed] When [Image capture mode] is set to [60fps Mode] or [50fps Mode], [Privacy Zone Format] cannot be set to [Blurring]. [Privacy Zone Format] is set to [Block].
- [New X Fixed] If [Privacy Zone Format] is set to [Blurring], [Lens distortion compensation] cannot be used.
- [New X Fixed-8M][New X Fixed-5M] When [Privacy Zone Format] is set to [Blurring], the frame rate is limited to the maximum 12.5fps when the maximum 15fps(25fps mode is selected).
- [New X Fixed-2M][New X Fixed-5M] When [Privacy Zone Format] is set to [Blurring], the zoom ratio is limited to a maximum of 3.1 times.
- [New X Fixed-8M] When [Privacy Zone Format] is set to [Blurring], the zoom factor is limited to up to 2 times.
- [Blurring] in [Privacy Zone Display Format] and [AI Privacy Guard (WV-XAE201W)] cannot be used at the same time.

8.2 [SD memory card] for setting SD Memory Cards

On the Basic Page, press the [SD memory card] tab. Refer to the following how to display and operate the Advanced menu.

→5.1 [How to display](#)

→5.2 [How to operate](#)

Here, settings for the SD Memory Card are made.



[Note:]

- The layout of each setting item varies depending on the model.
- Refer to the catalog specifications for the functions installed in each model.



[Note:]

- [Rapid PTZ] Refer to [Insert/Remove SD memory card mode] to install and remove the SD Memory Card.

Operation mode

[SD memory card]

You set whether to use the SD Memory Card or not.



[Note:]

- If [Image capture mode] is set to [60fps Mode] or [50fps mode], the SD Memory Card functions are not available. [SD memory card] is set to [Not use].

[Ext. software mode]

This setting is set to [On] when the installed function extension software uses the SD Memory Card of the computer.

[On]:The function extension software can use the SD Memory Card of the computer.

[Off]:The function extension software cannot use the SD Memory Card of the computer.



[Note:]

- For the functional extension software we sell and provide, please refer to our technical information website<Control No. C0103>.
- It is recommended to format the SD Memory Card when setting the function extension software mode from [On] to [Off].
- The operation of the recording function to the SD Memory Card cannot be guaranteed when the extended software using the SD Memory Card is operated.

[SD memory card file system type]

You can select the file system format of the SD memory card. This can be selected only when [Ext. software mode] is [On].

[FAT(FAT16/FAT32/exFAT)]:FAT formatted SD memory cards can be used.

[ext(ext4)]:ext formatted SD memory cards can be used.



[Important]

- If you change [SD Memory Card File System Format], click the [Execute] button in [Format] to format the SD memory card.



[Note:]

- When “ext(ext4)” is selected, the SD memory card can be used only with function extension software. Therefore, you will not be able to use functions such as recording video and audio to the SD memory card, or notification of remaining space in the SD memory card.
- When “ext(ext4)” is selected, the past information on the SD memory card will be deleted and cannot be displayed in the [Status] tab of the Maintenance page.
→16.3 [Status] for checking the status
- When “ext(ext4)” is selected, the capacity of the SD memory card cannot be displayed.
→8.2 [SD memory card] for setting SD Memory Cards
→2.7 Display the log list
→2.4.2 View images from a tablet terminal

[Audio recording]

You can set whether to record audio data when storing movies in MP4 format.

[Off]:Audio data is not saved in movies (MP4 format).

[On]:Audio data is saved in the movie (MP4 format).



[Note:]

- If you use [Audio recording], you must set [Recording format] to streams.

[Remaining capacity notification]

To notify the remaining capacity of the SD Memory Card using the mail notification function or the unique alarm notification function, select the following whether to start notification when the free space becomes the %.

50%/ 20%/ 10%/ 5%/ 2%



[Note:]

- Remaining capacity notification is made for each remaining capacity value below the set value.
For example, when set to [50%], the remaining capacity is 50%, 20%, 10%, 5%, and 2%, respectively. The timing of notification may deviate slightly.

[Overwrite]

You set whether to overwrite and save images when the free space on the SD Memory Card is

running low.

[On]:If the free space on the SD Memory Card decreases, the old image is overwritten and saved repeatedly.

[Off]:If the SD Memory Card has no free space, the SD Memory Card stops storing data.



[Important]

- If you do not want to use the SD Memory Card, set it to [Not use].
- Before removing the SD Memory Card from the computer, be sure to set it to [Not use]. If the SD Memory Card is set to [Use], the SD Memory Card may be damaged.
- When the SD Memory Card is set to [Use], the SD Memory Card is saved according to the [Save trigger] setting.
- After installing the SD Memory Card, set it to [Use].
- If the image update speed is high, the timing and interval of notification and recording may be misaligned. In addition, when multiple users receive images, notification or recording may not be performed as set. In that case, slow down the image update rate.
- The number of SD Memory Card rewrites is limited. If rewriting is frequent, the life of the watch may be shortened.
- The life of the SD Memory Card is affected by the number of image files saved to the SD Memory Card and the number of logs written.
- You can reduce the number of files saved to the SD Memory Card by selecting the stream in [Recording format] and setting the smaller value in [Bit Rate*/Client] of the stream to be recorded.
- If the SD Memory Card is written more frequently and the writing speed decreases, it is recommended to replace the new SD Memory Card.
- When switching from [Off] to [On], when the free space on the SD Memory Card is small, old images may be deleted to prepare for writing.

SD Memory Card security setting

[Additional info for detecting alteration]

Set whether to add information to enable detection when data on the SD Memory Card is falsified. Falsification detection supports only video (MP4 format) and can be checked using dedicated software.

Please refer to our Technical Information Website provides specific software for tampering detection and how to use it.<Control No. C0304>.

To Advanced Settings>>Click the [button] to display the setting window for adding falsification

detection information in a separate window.

→8.3 [Alteration detection] for detecting tampering

[SD memory card password lock]

Set the password on the SD Memory Card. When you set the password, you cannot write to or read from the SD Memory Card on any device other than this unit. If the SD Memory Card is stolen or lost, the risk of leakage of the recorded data can be reduced.

[Set]

If an SD Memory Card with no password set is inserted, the password can be set using the Set button.

[Password]/[Retype password]

Type a password.

Number of characters that can be entered:4 to 16 characters

Characters that cannot be entered:Double-byte and single-byte symbols " &

[Reset]

If an SD Memory Card with the password set has been inserted, the password can be canceled by pressing the release button.

[Password]

Type a password.

Number of characters that can be entered:4 to 16 characters

Characters that cannot be entered:Double-byte and single-byte symbols " &

[Change]

If an SD Memory Card with the password already set is inserted, the password can be changed by using the Change button.

[Old password]/[New password]/[Retype new password]

Type a password.

Number of characters that can be entered:4 to 16 characters

Characters that cannot be entered:Double-byte and single-byte symbols " &

[Status]

Displays the password lock setting status.

[During locking]:The SD Memory Card has a password and the lock function is enabled.

[Not set]:Lock function is disabled

The password setting status of the SD Memory Card is displayed.

[Password already set]:The password is set correctly.

[Error (unsupported SD memory card)]:Password lock not supported card is inserted. Check that the SDHC Memory Card or SDXC Memory Card is inserted.

[Error (password mismatch)]:The SD Memory Card cannot be used because the password set on the SD Memory Card and the password set on this computer do not match. Confirm the password is correct.

[Errors (other errors)]:This message is displayed when an error occurs in the SD Memory Card. Check the SD Memory Card.



[Note:]

- The password lock function supports SDHC memory card or SDXC memory card only.
- When using an SD Memory Card with Password lock set on a device other than this device, release the password by pressing the Password lock release button, and then remove the SD Memory Card from the card. You cannot cancel the password on any device other than the camera, such as a PC.
- If the [SD memory card password lock] [Status] is [Lock] and the SD Memory Card with no password setting is inserted into the computer, the password is automatically set to the SD Memory Card.



[Important]

- If you forget the set password, you cannot cancel the password. Since the SD Memory Card with the password set cannot be used, be sure to manage it carefully.
- If you forget the set password and want to replace it with a new SD Memory Card, set the [SD memory card password lock] [Status] to [Not been set] in advance by following one of the steps below.
Enter the password using the release button and press the set button.
-Initialize the set value from the maintenance page.

Recording stream

[Recording format]

Select the type of image data to be saved on the SD Memory Card.

[Off]:Image data is not saved.

[JPEG(1)]:Still image (JPEG(1)) is saved. Save your data according to the [JPEG(1)] Image capture size on the [Image] tabs of the video and audio pages.

[JPEG(2)]:Still image (JPEG(2)) is saved. Save your data according to the [JPEG(2)] Image capture

size on the [Image] tabs of the video and audio pages.

[Stream(1)]: Save the movie (stream (1)) in MP4 format. Save your data according to the [Stream(1)] settings on the [Image] tabs of the video and audio pages.

[Stream(2)]: Save the movie (stream (2)) in MP4 format. Save your data according to the [Stream(2)] settings on the [Image] tabs of the video and audio pages.

[Stream(3)]: Save the movie (stream (3)) in MP4 format. Save your data according to the [Stream(3)] settings on the [Image] tabs of the video and audio pages.

[Stream(4)]: Save the movie (stream (4)) in MP4 format. Save your data according to the [Stream(4)] settings on the [Image] tabs of the video and audio pages.



[Important]

- Use an UHS-I (Ultra High Speed-I)-compatible card for the Speed Class 10 SD Memory Card.
- It is recommended to use the microSD memory card dedicated to i-PRO devices.
- When using SD Memory Cards other than those compatible with Speed Class 10, the bit rate of streams selected with [Recording format] should be 6144 kbps.
- When using SD Memory Cards compatible with Speed Class 10, the bit rate of streams selected by [Recording format] should be up to 12288 kbps.
- [MULTI] The SD Memory Card cannot be used except for the Speed Class 10.
- [MULTI] The bit rate of the streams selected in [Recording format] should be up to 4096 kbps.



[Note:]

- When [Stream] is selected, the [Stream] settings in the [Image] tabs of the video and audio pages are [Streams].&This switches to the [Record movie] setting.
- When [Recording format] is changed to [Stream], the following functions may be corrected.
 - If [Transmission priority] is set to [Best effort], it is set to [Frame rate].
 - If [Refresh interval] is set to [2s], [3s], [4s], or [5s], then it is set to [1s].
- [Recording format] cannot be changed to [JPEG] if [On] is set to [Additional info for detecting alteration].
- If [Recording format] is [Stream], the file to be saved is named automatically.
- If [Recording format] is [Stream], there may be fewer users that can be connected.
- If you configure [On] for [Audio recording], the maximum bit rate that can be configured for streams is limited.
- If you configure [On] for [Additional info for detecting alteration], the maximum

bit rate that can be configured for streams is limited.

- [MULTI] If [Stream] is selected in [Recording format], the bit rate is restricted.

[Save trigger]

Select the method below to save images on the SD Memory Card.

[FTP/SFTP periodic transmission error]:FTP/Save the image when periodic transmission to the SFTP server fails.

This option is available only when [JPEG] is selected in [Recording format].

[Alarm input]:Saves the image when an alarm is generated.

[Manual]:Save the image manually.

[Schedule]:Save the image according to the schedule settings. This option is available only when [Stream] is selected in [Recording format].

→15 [\[Schedule\] for scheduling](#)

When [Alarm input] is selected in [Save trigger], the alarm type can be selected from the following.

[Terminal 1]:The image is saved when an alarm is generated at terminal 1.

[Terminal 2]:Image is saved when alarm is generated at terminal 2.

[Terminal 3]:The image is saved when an alarm is generated at terminal 3.

[VMD]:Image is saved when operation detection occurs.

[SCD]:The image is saved when undesired detection occurs.

[Impact detection]:Image is saved when impact detection occurs.

[Casing open detection]:Image is saved when opening detection occurs.

[Auto track]:Save the image when auto tracking occurs.

[Command alarm]:Saves the image when a command alarm is entered.



[Note:]

- If [Recording format] is streamed, [FTP/SFTP periodic image transmission error] cannot be set.
- To generate an alarm, use the [Alarm] tabs to set the alarm.
- If [Recording format] is [JPEG], [Schedule] cannot be set.
- When connected to our network disk recorder, [Save trigger] may be grayed out by [Network failure]. To change the [Save trigger] setting after you disconnect the recorder, set [SD memory card] to [Not use] and then set [Use] again.
- If [GOP control] is set to Advanced (Fixed GOP 60s + 1s keyframe), alarm recording cannot be set.
- Images are not recorded when sound detection alarm is generated.

[JPEG manual storage recording](#)

| JPEG recording(Manual) | |
|------------------------|------|
| File name | img_ |
| Image saving interval | 1fps |

This setting is available only when [Recording format] is set to [JPEG(1)] or [JPEG(2)] and [Save trigger] is set to [Manual].

[File name]

Enter the file name for saving images to the SD Memory Card. The following file names are actually saved.

File name:File name entered + Date and time (year, month, day, minute, second) + Sequence number

Number of characters that can be entered:1 to 8 characters

Characters that cannot be entered:Double-byte and single-byte symbols " & * / : ; < > ? ¥ |

[Image saving interval]

If [Save trigger] is set to [Manual], select the interval to save images to the SD Memory Card from the following.

When [Image capture mode] is set to 30 fps/15 fps: 0.1 fps/0.2 fps/0.33 fps/0.5 fps/1 fps

When [Image capture mode] is set to 25 fps/12.5 fps: 0.08 fps/0.17 fps/0.28 fps/0.42 fps/1 fps

JPEG recording (when alarm occurs)

| JPEG recording(Alarm) | | |
|----------------------------------------------------------------|-------------------------------|------------------------------------------|
| File name | img_ | |
| Image saving interval/Number of images to be saved(Pre alarm) | Image saving interval 1fps | Number of images to be saved Off |
| Image saving interval/Number of images to be saved(Post alarm) | Image saving interval 1fps | Number of images to be saved 100 pics |

This setting is available only when [Recording format] is set to [JPEG(1)] or [JPEG(2)] and [Save trigger] is set to [Alarm input].

[File name]

Enter the file name for saving images to the SD Memory Card. The following file names are actually saved.

File name:File name entered + Date and time (year, month, day, minute, second) + Sequence

number

Number of characters that can be entered: 1 to 8 characters

Characters that cannot be entered: Double-byte and single-byte symbols " & * / : ; < > ? ¥ |

[Storage interval/number of images (pre-alarm)] [Image saving interval]

When [Save trigger] is set to [Alarm input], select the pre-alarm image interval to save the image to the SD Memory Card.

When [Image capture mode] is set to 30 fps/15 fps: 0.1 fps/0.2 fps/0.33 fps/0.5 fps/1 fps

When [Image capture mode] is set to 25 fps/12.5 fps: 0.08 fps/0.17 fps/0.28 fps/0.42 fps/1 fps

[Storage interval/number of images (pre-alarm)] [Number of images to be saved]

Select the number of pre-alarm images to be saved to the SD Memory Card when an alarm is generated.

[Off]/[1 pic]/[2 pics]/[3 pics]/[4 pics]/[5 pics]

[Storage interval/number of images (Post alarm)] [Image saving interval]

If [Save trigger] is set to [Alarm input] or [Manual], select the intervals below to save images to the SD Memory Card.

When [Image capture mode] is set to 30 fps/15 fps: 0.1 fps/0.2 fps/0.33 fps/0.5 fps/1 fps

When [Image capture mode] is set to 25 fps/12.5 fps: 0.08 fps/0.17 fps/0.28 fps/0.42 fps/1 fps

[Storage interval/number of images (Post alarm)] [Number of images to be saved]

Select the number of alarm images to be saved to the SD Memory Card when an alarm is generated from the following list.

[10 pics]/[20 pics]/[30 pics]/[50 pics]/[100 pics]/[200 pics]/[300 pics]/[500 pics]/[1000 pics]/[2000 pics]/[3000 pics]

Movie recording (when alarm is generated)

| | |
|---------------------------------|-------|
| Stream recording(Alarm) | |
| Pre alarm (recording) duration | Off ▼ |
| Post alarm (recording) duration | 30s ▼ |

This setting is available only when the [Recording format] of the SD Memory Card is set to streaming and [Save trigger] is set to [Alarm input].

[Pre alarm (recording) duration]

Select whether to record before alarm. Sets the time to save to the SD Memory Card.

[Off]/ [1s]/ [2s]/ [3s]/ [4s]/ [5s]/ [8s]/ [10s]/ [15s]/ [20s]/ [25s]/ [30s]/ [40s]/ [50s]/ [60s]/ [90s]/ [120s]



[Note:]

- The values that can be set depend on the resolution and bit rate of the stream to be recorded. The higher the bit rate, the smaller the maximum value that can be set as the pre-alarm time.

[Post alarm (recording) duration]

Sets the time to save to the SD Memory Card after an alarm is generated.

[10s]/ [20s]/ [30s]/ [40s]/ [50s]/ [60s]/ [120s]/ [180s]/ [240s]/ [300s]

*Actual recording time may be longer than the time set for the post alarm time.

SD memory card information

[Remaining capacity]

The remaining capacity and total capacity of the SD Memory Card are displayed.

Depending on the status of the SD Memory Card, it may be displayed as follows.

| Within the display | Description |
|--------------------|--------------------------------------------------------------------------------------------------------------|
| -----MB/-----MB | SD Memory Card is not inserted. Otherwise, the remaining capacity cannot be acquired due to a read error. |
| *****MB/*****MB | SD Memory Card is not formatted. |
| #####MB/#####MB | The password lock of the SD Memory Card cannot be canceled. |



[Note:]

- When [Overwrite] is set to [Off] and the remaining capacity of the SD Memory Card becomes [0MB], images are not saved to the SD Memory Card. When the free space on the SD Memory Card runs out, the specified mail address and unique alarm notification destination can be notified with the notification function.
 → [12.4.2 Mail sending when an alarm is generated](#)
 → [12.12 \[Notification\] to set alarm notification](#)

[Format]

To format the SD memory card, click the [Execute] button.

Format in the file format selected in [SD Memory Card File System Format].



[Note:]

- When formatting an SD memory card with [ext(ext4)] selected for [SD Memory Card File System Format], formatting may take about 20 minutes until it is completed depending on the SD memory card.
- After formatting the SD memory card in ext format, check the operation of the extension software using the SD memory card.



[Important]

- Prior to formatting, set [SD memory card] to [Use] on the basic pages.
→8.2 [SD memory card] for setting SD Memory Cards
- The SD Memory Card must be formatted using the [SD memory card] tabs before using the SD Memory Card. The following functions may not work properly when formatted outside of the [SD memory card] tabs.
 - Save/retrieve image when alarm is generated
 - Save/retrieve images when manually saved
 - Save/retrieve images using the Schedule function
 - Save/retrieve alarm log, manual/schedule save log, system log
 - Saving/retrieving images using SD Memory recording function of our network disk recorder
 - Play/download images on the SD Memory Card
- When formatting is performed, the operation is interrupted if another user is working on it.
- You cannot write to the SD Memory Card during formatting.
- When formatting is performed, all data stored on the SD Memory Card are deleted.
- Do not turn off the computer during formatting.
- After formatting, the SD Memory Card displays less than the total amount of space because it creates the initial directory required to operate.
- The use of an SD Memory Card for i-PRO devices is recommended.
- When recording images repeatedly on an SD Memory Card using the automatic overwrite function, use an SD Memory Card with high reliability and durability.
- Use an UHS-I (Ultra High Speed-I)-compatible card for the SD Memory Card that supports the speed class Class 10.

Installing and removing the SD Memory Card

[Insert/Remove SD memory card mode]

To install or remove an SD Memory Card, press [Execute].

After the SD Memory Card has been installed and removed, click the [Release] button.



[Note:]

- [Rapid PTZ] [Insert/Remove SD memory card mode] will appear only in Rapid PTZ Camera.



[Note:]

- [Rapid PTZ] "Now Maintenance Mode" is displayed on the image during [Insert/Remove SD memory card mode], and functions such as pan/tilt operation are restricted.

8.3 [Alteration detection] for detecting tampering

When the data on the SD Memory Card is falsified, the data can be detected using the dedicated software.

Falsification detection supports only video files (MP4 format).

For information on how to set up falsification detection, please refer to the support video page of the support site.<Control No. P0001>.

Please refer to our Technical Information Website provides specific software for tampering detection and how to use it.<Control No. C0304>.



[Note:]

- If you use Falsification Detect, you must set [Recording format] to streaming.

| | |
|------------------------------------------|---------------------------------------------------------------|
| Alteration detection | |
| Select certificate | Pre-installed ▾ |
| Additional info for detecting alteration | <input type="radio"/> On <input checked="" type="radio"/> Off |
| Set | |
| Pre-installed certificate | |
| Certificate download | Execute |
| CA Certificate | |
| CRT key generate | Execute |
| Generate Certificate Signing Request | Execute |
| CA Certificate install | ファイルを選択 選択されていません Execute |
| Information | Invalid Confirm Delete |
| Certificate download | Execute |
| Close | |

[Select certificate]

Select the certificate to use for falsification detection.

[Pre-install]: Select the pre-installation certificate.

CA: Select a CA certificate. This is displayed only if the CA certificate is installed.

[Additional info for detecting alteration]

Set whether to add the information for detecting tampering to the movie file (MP4 format) to be saved in the SD Memory Card.



[Note:]

• If the [Recording format] of [Recording stream] is set to JPEG, the setting cannot be changed to On.

[Pre-install Certificate-Get Certificate]

Click the Run button to download the route certificate for the pre-installation certificate. Use the downloaded certificate to detect falsification of movies (MP4 file) on the SD Memory Card using the dedicated software.

[CA certificate–CRT key generation]

Creates a CRT key (encryption key) for use in falsification detection.

CRT key generation is performed in [CRT key generation dialog] displayed when [Execute] is clicked.

[CA Certificate–Create Signature Request (CSR)]

When using CA certificates issued by a certification authority as CA certificates for use in tampering detection, it generates a signature request (CSR) to apply to the certification authority.

Create a signature request (CSR) by clicking on the [Execute] button. This is displayed in the [Create Signature Request (CSR) dialog].

[CA certificate–certificate installation]

This feature installs certificates (CA certificates) issued by certification agencies and displays information about installed certificates (CA certificates).

When [Select File] is clicked, the [Open File Dialog] is displayed. Select the certificate (CA Certificate) file issued by the certification authority. Click [Execute] to install the certificate (CA Certificate).

If a certificate (CA certificate) is installed, the file name of the installed certificate is displayed.

[CA certificate–information]

The information of the certificate (CA certificate) issued by the certification authority is displayed.

When [Execute] is clicked, the registered contents of the installed certificate (CA certificate) are displayed in [CA Certificate Confirmation Dialog].

Clicking [Delete] deletes the installed certificate (CA certificate).

[CA Certificate–Get Certificate]

The certificate (CA certificate) issued by the certification organization is downloaded from this machine.

Use the downloaded certificate to detect falsification of movies (MP4 file) on the SD Memory Card using the dedicated software.



[Important]

- When deleting a valid certificate (CA certificate), make sure that you have a backup of the certificate (CA certificate) on your PC or recording media. To reinstall, a certificate (CA certificate) is required.

8.4 How to set up falsification detection



[Note:]

- The [falsification detection] setting can only be selected for models that have a falsification detection function.
- Refer to the catalog specifications for the functions installed in each model.

For information on how to set up falsification detection, please refer to the support video page of the support site.<Control No. P0001>.

8.5 [Overlay image] to set overlays



[Note:]

- The [Overlay image] setting can only be selected for models that have a Overlay image function.
- Refer to the catalog specifications for the functions installed in each model.

The overlay image function embeds images uploaded to the computer into live images (overlay display).

On the Basic Page, press the [Overlay image] tab. Refer to the following how to display and operate the Advanced menu.

→5.1 [How to display](#)

→5.2 [How to operate](#)

Here, the overlay image function is set.

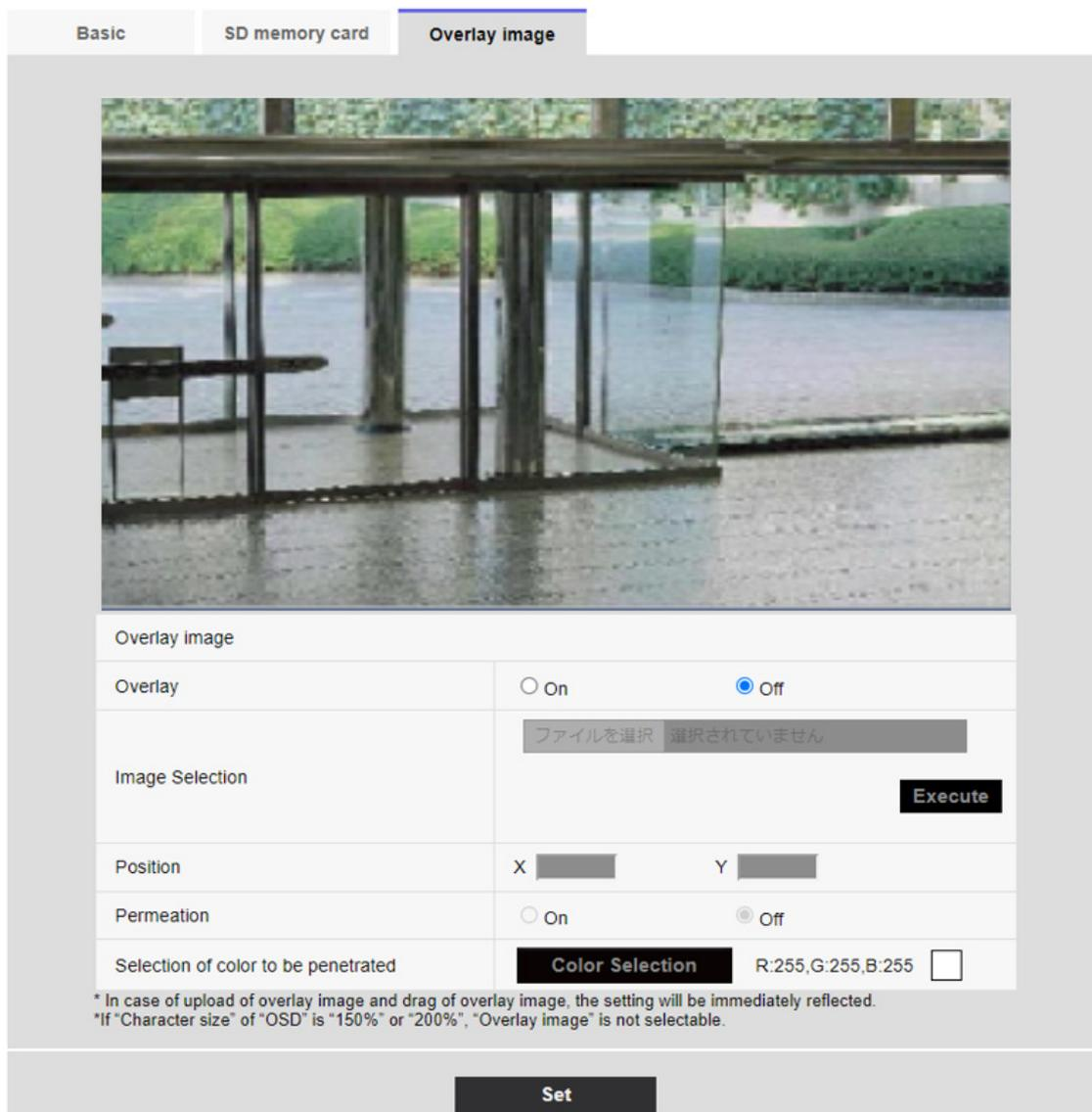

[Overlay image]

Select the camera for which you want to set the overlay.

[Camera 1]:Sets camera 1 overlay.

[Camera 2]:Sets camera 2 overlay.

[Camera 3]:Set the camera 3 overlay.

[Camera 4]:Set the camera 4 overlay.



[Note:]

• [MULTI] [Camera selection] can be selected only for Multi-directional cameras.

[Overlay]

Use [On] or [Off] to set whether the uploaded images are overlaid or not.

[On]:Displays the overlay. When set to [On], overlaid images are recorded during recording on the SD Memory Card.

[Off]:Overlay is not displayed.



[Note:]

- If [[Character size]] is set to [150%] or [200%] for [Characters in Date/Time Screen], [Overlay] cannot be set.
- [New X Fixed] If [Image capture mode] is set to [60fps Mode] or [50fps Mode], [Overlay] cannot be set.
- Refer to the catalog specifications for the functions installed in each model.

[Image Selection]

Follow the procedure below to upload an overlay image file to the computer.

- 1) Click the [Select File] button to select the image file saved in the PC.
- 2) Click [Execute] to upload the selected image files to the computer. When an image file is uploaded, the uploaded image (uploaded image) is displayed as an overlay on the setting screen.

You can use image files with the following specifications for overlay display:

- Image format: 256 color bitmap (BMP: Windows format)
- Image size: 24 pixels x 24 pixels to 512 pixels x 512 pixels
- File capacity: 257 Kbytes or less



[Note:]

- Save the image file in a folder that does not use space or double-byte characters. You may not be able to upload files saved in spaces or folders using double-byte characters.



[Important]

- Do not turn off the computer or operate the machine during upload of the image file.
- The uploaded image displayed is reduced depending on the resolution of the live image. The image quality of the uploaded image may deteriorate and be displayed. Check the image overlaid on the live image page.
- The uploaded image is saved when uploaded.

[Position]

The uploaded image display position (upper left corner of the image) is displayed with [X] and [Y] coordinates.

Basic
SD memory card
Overlay image



| Overlay image | |
|-------------------------------------|---------------------------------------------------------------------------------------------------------------------------------------------------------|
| Overlay | <input checked="" type="radio"/> On <input type="radio"/> Off |
| Image Selection | <input type="button" value="Choose File"/> No file chosen <div style="text-align: right; margin-top: 5px;"><input type="button" value="Execute"/></div> |
| Position | X <input type="text" value="274"/> Y <input type="text" value="170"/> |
| Permeation | <input type="radio"/> On <input checked="" type="radio"/> Off |
| Selection of color to be penetrated | <input type="button" value="Color Selection"/> R:255,G:255,B:255 <input type="text"/> |

* In case of upload of overlay image and drag of overlay image, the setting will be immediately reflected.
 * If "Character size" of "OSD" is "150%" or "200%", "Overlay image" is not selectable.

There are two ways to change the display position of uploaded images.

- Drag and drop the uploaded image displayed by using the mouse.
- Enter the coordinates for [X] and [Y] and press [Set].

Input digits:

-If [Image capture mode] is [16:9 mode]

X: 0 to 639, minus the size next to the uploaded image

Y: 0 to 359, minus the vertical size of the uploaded image

-If [Image capture mode] is [4:3 mode]

X: 0 to 639, minus the size next to the uploaded image

Y: 0 to 479, minus the vertical size of the uploaded image



[Note:]

- You can change the display position by moving the red frame displayed when dragging the uploaded image.
- Coordinates for displaying uploaded images to protrude from the top of the setting screen cannot be set.
- When uploaded images are moved by the mouse, the display position is saved without clicking the [Set] button.
- Even if you move the uploaded image to the edge of the screen, there may be a gap between the image and the edge of the screen.



[Important]

- After changing the [Image capture mode] settings, check the position of the uploaded images. If the display position is misaligned, set the display position again. If the uploaded image is displayed out of the setting screen, the display position returns to the initial value (center of the live image).

[Permeation]

Use [On] or [Off] to set whether or not the selected colors are transmitted by [Selection of color to be penetrated].

[On]:Transmits colors selected in [Selection of color to be penetrated].

[Off]:The colors selected in [Selection of color to be penetrated] are not transmitted.

[Selection of color to be penetrated]

Select the color to be transmitted as shown below.

- 1 Clicking [Color Selection] displays the sub-window with the uploaded images.

8 [Basic] for basic setup of the machine

8.5 [Overlay image] to set overlays

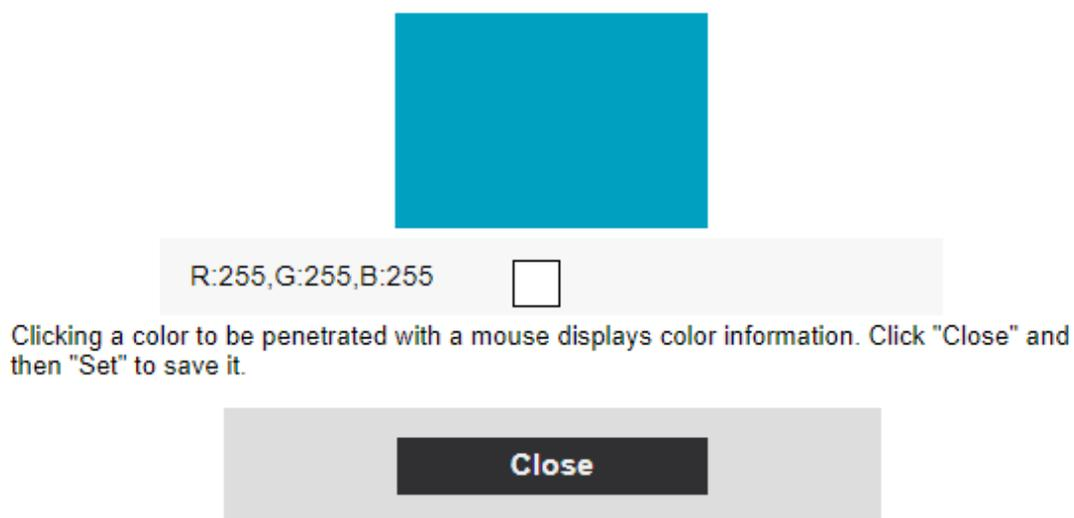

- 2 Click the color to be transmitted in the displayed image. The selected color and RGB values are displayed.
- 3 Close the sub-window by clicking [Close].
- 4 Finally, clicking on the [Set] will transparent the selected colors.

9 [Image/Audio] for setting images and sound files

Image/audio pages configure JPEG images, H.265 images and H.264 images, and set image quality and sound.

Video/Audio pages consist of the [Image], [Image quality], and [Audio] tabs.



[Note:]

- The items that can be set differ depending on the function of the model.
- Refer to the catalog specifications for the functions installed in each model.

9.1 [Image] to set the imaging modes

Click the [Image] tabs on the video pages. Refer to the following how to display and operate the Advanced menu.

→5.1 [How to display](#)

→5.2 [How to operate](#)

[Image capture mode]

Select the image to be displayed on the live image, etc.

| Model | Image capture mode |
|--------------------------------------------------------------------------------------------------------------------------------------|----------------------------------------------------------------------------------------------------------------------------------------------------------------------------------------------------|
| Rapid PTZ camera (X/S series, Image capture size: 2MP), Multi-directional + PTZ (PTZ part) | 16:9 mode(30fps mode) 16:9 mode(25fps mode) 16:9 mode(60fps mode) 16:9 mode(50fps mode) 4:3 mode(15fps mode) 4:3 mode(12.5fps mode) 4:3 mode(30fps mode) 4:3 mode(25fps mode) |
| Rapid PTZ Camera(X/S Series, Image capture size: 8M (4K)), Rapid PTZ Camera(X/S Series, Image capture size: 6MP), Indoor PTZ cameras | 16:9 mode(30fps mode) 16:9 mode(25fps mode) |
| Multi-directional cameras (8-megapixel models) | 8 megapixels [16:9](15 fps mode) 8 megapixels [16:9](12.5 fps mode) |

9 [Image/Audio] for setting images and sound files

9.1 [Image] to set the imaging modes

| | |
|------------------------------------------------------------------------------------------------------------------------|--------------------------------------------------------------------------------------------------------------------------------------------------------------------------------------------------------------------------------------------------------------------------------------------------------------|
| | 8 megapixels [16:9](15 fps Dual mode) 8 megapixels [16:9](12.5 fps Dual mode) |
| Multi-directional camera (5-megapixel model) | 5 megapixels [16:9](15fps mode) 5 megapixels [16:9](12.5fps mode) 5 megapixels [16:9](15fps Quad mode) 5 megapixels [16:9](12.5fps Quad mode) 5 megapixels [4:3](15fps mode) 5 megapixels [4:3](12.5fps mode) 5 megapixels [4:3](15fps Quad mode) 5 megapixels [4:3](12.5fps Quad mode) |
| Multi-directional camera (4-megapixel model) | 4 mega pixel [16:9](30fps mode) 4 mega pixel [16:9](25fps mode) 4 mega pixel [16:9](30fps Dual mode) 4 mega pixel [16:9](25fps Dual mode) |
| Compact Dome cameras (X/S series, Image capture size: 4MP) Compact Dome cameras (U series, Image capture size: 4MP) | 16:9 mode(30fps mode) 16:9 mode(25fps mode) 16:9 mode(2688x1520 30fps mode) 16:9 mode(2688x1520 25fps mode) 4:3 mode(15fps mode) 4:3 mode(12.5fps mode) 4:3 mode(30fps mode) 4:3 mode(25fps mode) |
| Compact Dome cameras (X/S series, Image capture size: 2MP) | 16:9 mode(30fps mode) 16:9 mode(25fps mode) 16:9 mode(60fps mode) 16:9 mode(50fps mode) 4:3 mode(15fps mode) 4:3 mode(12.5fps mode) 4:3 mode(30fps mode) 4:3 mode(25fps mode) |
| Compact Dome cameras (U series, Image capture size: 2MP) | 16:9 mode(30fps mode) 16:9 mode(25fps mode) 4:3 mode(30fps mode) 4:3 mode(25fps mode) |
| New X Fixed Cameras (Image capture size: 2MP) | 16:9 mode(30fps mode) 16:9 mode(25fps mode) 16:9 mode(60fps mode) 16:9 mode(50fps mode) 4:3 mode(30fps mode) |

| | |
|-----------------------------------------------|--------------------------------------------------------------------------------------------------------------------------------------------------------------------------------------------------|
| | 4:3 mode(25fps mode) 4:3 mode(60fps mode) 4:3 mode(50fps mode) |
| New X Fixed Cameras (Image capture size: 5MP) | 16:9 mode(30fps mode) 16:9 mode(25fps mode) 16:9 mode(60fps mode) 16:9 mode(50fps mode) 4:3 mode(30fps mode) 4:3 mode(25fps mode) 4:3 mode(60fps mode) 4:3 mode(50fps mode) |
| New X Fixed Cameras (Image capture size: 6MP) | 16:9 mode(30fps mode) 16:9 mode(25fps mode) 16:9 mode(60fps mode) 16:9 mode(50fps mode) |
| New X Fixed Cameras (Image capture size: 8MP) | 16:9 mode(30fps mode) 16:9 mode(25fps mode) 16:9 mode(60fps mode) 16:9 mode(50fps mode) |
| Corner cameras | 16:9 mode(30fps mode) 16:9 mode(25fps mode) 4:3 mode(30fps mode) 4:3 mode(25fps mode) |



[Important]

• If you change the image pickup mode setting with the following area setting, the position will be misaligned. Therefore, after setting the imaging mode, set each area.

Mask area

→9.4.2 Set the mask area

-Privacy Zone

→9.4.6 Setting the privacy zone (Privacy zone setting screen)

-Operation detection area

→12.6 [VMD area] to set the motion detection area

Undesired detection area

→12.8 [SCD area] to set up undesired detection areas

VIQS area

→9.4.8 Set up the VIQS area

-overlay image

→8.5 [\[Overlay image\] to set overlays](#)

- The [16:9 mode(60fps mode)]/[16:9 mode(50fps mode)]/[4:3 mode(15fps mode)]/[4:3 mode(12.5fps mode)] imaging modes do not allow the use of advanced features or autotracking features.
- [MULTI] If a slow shutter mode is set during operation, such as at night, it may take a lot of time to complete the setting.
- [New X Fixed]If [Stabilizer] is set to [On] when [16:9 mode(60fps mode)]/[16:9 mode(50fps mode)]/[4:3 mode (60fps mode)]/[4:3 mode (50fps mode)] is set to Image capture mode, it is changed to [Off].If so, a reboot will be performed.



[Note:]

- If the VIQS area is enabled, make sure that the VIQS settings do not exceed the maximum range after changing the aspect ratio from [4:3] to [16:9].
- In 2 megapixels [16:9] (60 fps mode), when multiple streams are delivered, 60 fps delivery is not possible and the image may be displayed intermittently. If the voice is simultaneously delivered, the data will be delivered at 30 fps.

For other terms and conditions regarding stream delivery, please refer to our technical information website.<Control No. C0309>.

9.2 [Image] for setting JPEG images

Click on the [Image] tabs of the video and audio pages. Refer to the following how to display and operate the Advanced menu.

→5.1 [How to display](#)

→5.2 [How to operate](#)

Live image (initial display)

Here, the default setting to be displayed on the live picture is performed.

[Initial display stream]

Select the images to be displayed in Live image pages from the following.

Compact camera(U series)

JPEG(1)/ JPEG(2)/ [Stream(1)]/[Stream(2)]/[Stream(3)]/[Stream(4)]

Rapid PTZ Cameras, Indoor PTZ cameras, Compact camera(S series), New X fixed camera,

Corner cameras

JPEG(1)/ JPEG(2)/ [Stream(1)]/[Stream(2)]/[Stream(3)]/[Stream(4)]/[Multi-screen]

Multi-directional + PTZ (PTZ part)

JPEG(1)/ JPEG(2)/ [Stream(1)]/[Stream(2)]/[Stream(3)]/[Stream(4)]/[Multi-sensor + PTZ]

Multi-directional cameras

[4 image display stream(2)], [3 image display stream(2)], [2 image display stream(2)], [4 image display JPEG], [3 image display JPEG], [2 image display JPEG], [2 image display JPEG], [2 image display 1 stream(1)], [Camera 1 stream(2)], [Camera 1 JPEG], [Camera 2 stream(1)], [Camera 2 stream(2)], [Camera 2 JPEG], [Camera 3 stream(1)], [Camera 3 stream(2)], [Camera 3 JPEG], [Camera 4 stream(1)], [Camera 4 stream(2)], [Camera 4 JPEG]/[Camera 4 JPEG]/ [Multi-sensor + PTZ]



[Note:]

- Selecting JPEG enables you to select the update interval.
MJPEG/ [Refresh interval : 1s]/[Refresh interval : 3s]/[Refresh interval : 5s]/[Refresh interval : 10s]/[Refresh interval : 30s]/[Refresh interval : 60s]
- The streams can be selected when [Stream transmission] is [On].
- [MULTI] When [4 image display JPEG]/[3 image display JPEG] is selected, [Refresh interval : 1s] [Still image update: 3 seconds] cannot be selected.
- [MULTI] Select [4 image display stream (2)], [3 image display stream (2)], [4 image display JPEG], or [3 image display JPEG] to select the following display method.
[4 split]/[360 deg.]
[3 split]/[270 deg.]
- [MULTI] Four-image display is available for the four-eye model.
- [MULTI] Three-image display is available for the three-eye model.
- [MULTI_PTZ] Only Multi-directional/PTZ-integrated cameras can be selected for [Multi-directional + PTZ].

[JPEG image updating speed (movie)*]

Select the rate at which the JPEG image is updated.

If [Image capture mode] is set to [Single source [4:3](30fps mode)]/[Dual sources [4:3](15fps mode)]/[60fps mode]:

0.1fps/ 0.2fps/ 0.33fps/ 0.5fps/ 1fps/2fps/ 3fps/ 5fps/ 6fps/ 10fps/ 12fps/ 15fps/ 30fps

If [Image capture mode] is set to [Single source [4:3](25fps mode)]/[Dual sources [4:3](12.5fps mode)]/[50fps mode]:

0.08fps/ 0.17fps/ 0.28fps/ 0.42fps/ 1fps/ 2.1fps/ 3.1fps/ 4.2fps/ 5fps/ 8.3fps/ 12.5fps/ 25fps



[Note:]

- If [Stream transmission] is set to [On] and the value with [*] is set, the image updating rate may be lower than the set value. The value with [*] depends on the model. Refer to this item on the detailed camera setting screen for the relevant parameters.
- The [*] option is omitted.
- Depending on the network environment, resolution, image quality, number of simultaneous accesses, etc., the image update rate may be lower than the set value.
- If the image is not delivered at the set image update rate, you can reduce the resolution and image quality to close to the set value.
- The updating speed up to the value of the selected imaging mode can be selected.

JPEG

Here, the [Image capture size] [Image quality] of JPEG is set. For settings for H.265 (or H.264) images, see below.

→9.3 [Image] for setting up streams



[Note:]

- [MULTI] This setting is common to all cameras.
- [New X Fixed-8M][New X Fixed-5M] If [Image capture mode] is set to [60fps mode] or [50fps mode], [JPEG1][JPEG2] cannot be used.

[Image capture size]

When displaying a JPEG image, select the Image capture size of the image to be displayed.

Please refer to the following for the relationship between your model and symbols and terminology.

→1.2 Compatible models and symbols in this manual

New X fixed camera

| Aircraft type | Image capture mode | JPEG1 | JPEG2 |
|-----------------------------------------------------|-----------------------|-----------|---------|
| New X Fixed Cameras (Image capture size: 2MP) | 16:9 mode(30fps mode) | 1920x1080 | |
| | 16:9 mode(25fps mode) | | |
| | 16:9 mode(60fps mode) | | |
| | 16:9 mode(50fps mode) | 1280x720 | |
| | | 640x360 | 640x360 |
| | | 320x180 | |
| | 4:3 mode(30fps mode) | 2048x1536 | |
| | 4:3 mode(25fps mode) | 1280x960 | |

| | | | |
|-----------------------------------------------------|------------------------------------------------|--------------------------------------------------------------------------------------------------------------------------|---------|
| | 4:3 mode(60fps mode) 4:3 mode(50fps mode) | 640x480 320x240 | 640x480 |
| New X Fixed Cameras (Image capture size: 5MP) | 16:9 mode(30fps mode) 16:9 mode(25fps mode) | Only the same Image capture size set for stream (1), stream (2), stream (3) and JPEG (2) can be selected. | 640x360 |
| | 16:9 mode(60fps mode) 16:9 mode(50fps mode) | – | – |
| | 4:3 mode(30fps mode) 4:3 mode(25fps mode) | Only the same Image capture size set for stream (1), stream (2), stream (3) and JPEG (2) can be selected. | 640x480 |
| | 4:3 mode(60fps mode) 4:3 mode(50fps mode) | – | – |
| New X Fixed Cameras (Image capture size: 6MP) | 16:9 mode(30fps mode) 16:9 mode(25fps mode) | Only the same Image capture size set for stream (1), stream (2), stream (3) and JPEG (2) can be selected. | 640x360 |
| | 16:9 mode(60fps mode) 16:9 mode(50fps mode) | – | – |
| New X Fixed Cameras (Image capture size: 8MP) | 16:9 mode(30fps mode) 16:9 mode(25fps mode) | Only the same Image capture size set for stream (1), stream (2), stream (3) and JPEG (2) can be selected. | 640x360 |
| | 16:9 mode(60fps mode) 16:9 mode(50fps mode) | – | – |

Compact camera

| Aircraft type | Image capture mode | JPEG1 | JPEG2 |
|---------------------------------------------------------|--------------------------------------------------------------------|--------------------------------------------------------------------------------------------------------------|---------|
| Compact camera (X/S series, Image capture size: 4MP) | 16:9 mode(30fps mode) 16:9 mode(25fps mode) | Only the same Image capture size set for stream (1), stream (2), stream (3) and JPEG (2) can be selected. | 640x360 |
| | 16:9 mode(2688x1520 30fps mode) 16:9 mode(2688x1520 25fps mode) | Only the same Image capture size set for stream (1), stream (2), stream (3) and JPEG (2) can be selected. | 640x360 |
| | 4:3 mode(30fps mode) 4:3 mode(25fps mode) | 1280x960 640x480 320x240 | 640x480 |
| | 4:3 mode(15fps mode) 4:3 mode(12.5fps mode) | 2048x1536 1280x960 640x480 320x240 | 640x480 |
| Compact camera (X/S series, Image capture size: 2MP) | 16:9 mode(30fps mode) 16:9 mode(25fps mode) | 1920x1080 1280x720 640x360 320x180 | 640x360 |
| | 16:9 mode(60fps mode) 16:9 mode(50fps mode) | 1920x1080 1280x720 640x360 320x180 | 640x360 |
| | 4:3 mode(30fps mode) 4:3 mode(25fps mode) | 1280x960 640x480 320x240 | 640x480 |
| | 4:3 mode(15fps mode) 4:3 mode(12.5fps mode) | 2048x1536 1280x960 640x480 320x240 | 640x480 |

| | | | |
|-------------------------------------------------------|--------------------------------------------------------------------|--------------------------------------------------------------------------------------------------------------|---------|
| Compact camera (U series, Image capture size: 4MP) | 16:9 mode(30fps mode) 16:9 mode(25fps mode) | Only the same Image capture size set for stream (1), stream (2), stream (3) and JPEG (2) can be selected. | 640x360 |
| | 16:9 mode(2688x1520 30fps mode) 16:9 mode(2688x1520 25fps mode) | 2688x1520 1920x1080 1280x720 640x360 | 640x360 |
| | 4:3 mode(30fps mode) 4:3 mode(25fps mode) | 1280x960 640x480 320x240 | 640x480 |
| | 4:3 mode(15fps mode) 4:3 mode(12.5fps mode) | 2048x1536 1280x960 640x480 320x240 | 640x480 |
| Compact camera (U series, Image capture size: 2MP) | 16:9 mode(30fps mode) 16:9 mode(25fps mode) | 1920x1080 1280x720 640x360 320x180 | 640x360 |
| | 4:3 mode(30fps mode) 4:3 mode(25fps mode) | 1280x960 640x480 320x240 | 640x480 |

Corner cameras

| Aircraft type | Image capture mode | JPEG1 | JPEG2 |
|----------------|------------------------------------------------|--------------------------------------------------------------------------------------------------------------------------|---------|
| Corner cameras | 16:9 mode(30fps mode) 16:9 mode(25fps mode) | Only the same Image capture size set for stream (1), stream (2), stream (3), stream (4) and JPEG (2) can be selected. | 640x360 |

| | | | |
|--|----------------------------------------------|-----------------------------------------------------------------------------------------------------------------------------------------|-----|
| | 4:3 mode(30fps mode) 4:3 mode(25fps mode) | Only the same Image capture size set for stream (1), stream (2), stream (3), stream (4) and JPEG (2) can be selected. | VGA |
|--|----------------------------------------------|-----------------------------------------------------------------------------------------------------------------------------------------|-----|

PTZ cameras

| Aircraft type | Image capture mode | JPEG1 | JPEG2 |
|-----------------------------------------------------------------------------------------------------------------------------------------------------------------------------|------------------------|-----------------------------------------------------------------------------------------------------------------------------------------------------------------------------------------------------------|-----------|
| Rapid PTZ camera (X/S series, Image capture size: 2MP), Multi-directional + PTZ (PTZ part), Next generation aero PTZ cameras (Image capture size: 2MP) | 16:9 mode(30fps mode) | 1920x1080 | 640x360 |
| | 16:9 mode(25fps mode) | 1280x720 | |
| | 16:9 mode(60fps mode) | 640x360 | |
| | 16:9 mode(50fps mode) | 320x180 | 640x480 |
| | 4:3 mode(30fps mode) | 1280x960 | |
| | 4:3 mode(25fps mode) | 640x480 320x240 | |
| Rapid PTZ Camera(X/S Series, Image capture size: 8M (4K)), Indoor PTZ cameras (Image capture size: 8M (4K)) | 4:3 mode(15fps mode) | 2048x1536 | 640x480 |
| | 4:3 mode(12.5fps mode) | 1280x960 | |
| | | 640x480 320x240 | |
| Rapid PTZ Camera(X/S Series, Image capture size: 8M (4K)), Indoor PTZ cameras (Image capture size: 8M (4K)) | 16:9 mode(30fps mode) | 3840x2160 | 640x360*1 |
| | 16:9 mode(25fps mode) | 2560x1440 1920x1080 1280x720 640x360 320x180 Only the same Image capture size set for stream (1), stream (2), stream (3), stream (4) and JPEG (2) can be selected. | |
| Rapid PTZ | 16:9 mode(30fps mode) | 3328x1872 | |

| | | | |
|-------------------------------------------------------------------------------------------|-----------------------|-----------------------------------------------------------------------------------------------------------------------------------------------------------------------------------|-----------|
| Camera(X/S Series, Image capture size: 6MP), Indoor PTZ cameras (Image capture size: 6MP) | 16:9 mode(25fps mode) | 2560x1440 1920x1080 1280x720 640x360 320x180 Only the same Image capture size set for stream (1), stream (2), stream (3), stream (4) and JPEG (2) can be selected. | 640x360*1 |
|-------------------------------------------------------------------------------------------|-----------------------|-----------------------------------------------------------------------------------------------------------------------------------------------------------------------------------|-----------|

*1 JPEG (2) is set to [1280x720] if [640x360] is not selected for the resolution set in Streams (1), Streams (2), Streams (3), Streams (4), and JPEG (1) and four resolutions are set.

Multi-directional camera

| Aircraft type | Imaging mode | JPEG1 | JPEG2 |
|------------------------------------------------|-----------------------------------------|----------------------------------------------------------|--------------------------|
| Multi-directional cameras (8-megapixel models) | 8 megapixels [16:9](15 fps mode) | 3840x2160 | -- (Without function) |
| | 8 megapixels [16:9](12.5 fps mode) | 2560x1440 1920x1080 1280x720 640x360 320x180 | |
| | 8 megapixels [16:9](15 fps Dual mode) | 3840x2160 | |
| | 8 megapixels [16:9](12.5 fps Dual mode) | 2560x1440 1920x1080 1280x720 640x360 | |
| Multi-directional camera (5-megapixel model) | 5 megapixels [16:9](15fps mode) | 3072x1728 | |
| | 5 megapixels [16:9](12.5fps mode) | 2560x1440 1920x1080 1280x720 640x360 320x180 | |
| | 5 megapixels [16:9](15fps Quad mode) | 3072x1728 | |
| | 5 megapixels [16:9](12.5fps Quad mode) | 2560x1440 | |

| | | | |
|----------------------------------------------|------------------------------------------------------------------------------|----------------------------------------------------------|--|
| | | 1920x1080 1280x720 640x360 | |
| | 5 megapixels [4:3](15fps mode) 5 megapixels [4:3](12.5fps mode) | 3072x2304 2560x1920 1280x960 640x480 320x240 | |
| | 5 megapixels [4:3](15fps Quad mode) 5 megapixels [4:3](12.5fps Quad mode) | 3072x2304 2560x1920 1280x960 640x480 | |
| Multi-directional camera (4-megapixel model) | 4 mega pixel [16:9](30fps mode) | 2688x1520 | |
| | 4 mega pixel [16:9](25fps mode) | 2560x1440 1920x1080 1280x720 640x360 320x180 | |
| | 4 mega pixel [16:9](30fps Dual mode) | 2688x1520 | |
| | 4 mega pixel [16:9](25fps Dual mode) | 2560x1440 1920x1080 1280x720 640x360 | |

[Image quality]

Set the quality of JPEG images at each resolution.

[0 Super fine]/[1 Fine]/2/ 3/ 4/ [5 Normal]/6/ 7/ 8/ [9 Low]

9.3 [Image] for setting up streams

Click on the [Image] tabs of the video and audio pages. Refer to the following how to display and operate the Advanced menu.

→[5.1 How to display](#)

→[5.2 How to operate](#)

Here, H.265 (or H.264) images [bit rate per client], [Image capture size], [Image quality]

Configure, for example. For the settings of the JPEG image, refer to the following.

→[9.2 \[Image\] for setting JPEG images](#)

Stream

A stream is a system that simultaneously delivers images with different resolution and frame rates. The number of streams that can be delivered at the same time is expressed as the number of streams.

The number of streams depends on the model. Refer to the catalog specifications for the number of streams for each model.

[Stream transmission]

Use [On] or [Off] to set whether to deliver H.265 (or H.264) images.

[On]: Deliver H.265 (or H.264) images.

[Off]: The H.265 (or H.264) image is not delivered.



[Note:]

- If you set [Stream transmission] to [On], you can view both H.265 (or H.264) and JPEG images on live picture pages.

- If one of the streams' [Stream transmission] is set to [On], the image update rate of the JPEG image is limited.

For information about the rate of updating JPEG images when [Stream transmission] is set to [On], see below.

→[2.3.1 View camera images](#)

- [MULTI] If any one of the [Stream transmission] cameras is set to [On], the image updating rate of the JPEG image is limited.

- [MULTI] This setting can be set individually by each camera.

[Stream encoding format]

Select the compression method for the stream to be delivered.

H.265: H.265 images are delivered.

H.264: H.264 images are delivered.



[Note:]

- [MULTI] This setting is common to all cameras.

[Image capture size]

Select the resolution of the H.265 (or H.264) image from the following. Selection may be limited depending on the selected resolution.

Please refer to the following for the relationship between your model and symbols and terminology.

→[1.2 Compatible models and symbols in this manual](#)

New X Fixed Cameras

| Aircraft type | Image capture mode | H.265/H.264 | | | | |
|-----------------------------------------------------|------------------------------------------------------|------------------------|--------------------------|-----------------------------------|--------------------------------|--|
| | | Stream 1 | Stream 2 | Stream 3 | Stream 4 | |
| New X Fixed Cameras (Image capture size: 2MP) | 16:9 mode(30fps mode) | 1920x1080 1280x720 | 1920x1080 1280x720 | 1280x720 | | |
| | 16:9 mode(25fps mode) | 640x360 320x180 | 640x360 320x180 | 640x360 320x180 | 640x360 320x180 | |
| | 16:9 mode(60fps mode) | | | | | |
| | 16:9 mode(50fps mode) | | | | | |
| | 4:3 mode(30fps mode) | 2048x1536 | | | | |
| | 4:3 mode(25fps mode) | 1280x960 | 1280x960 | | | |
| | 4:3 mode(60fps mode) | VGA | VGA | VGA | VGA | |
| | 4:3 mode(50fps mode) | QVGA | QVGA | QVGA | QVGA | |
| New X Fixed Cameras (Image capture size: 5MP) | 16:9 mode(30fps mode) | 3072x1728 2560x1440 | 3072x1728 2560x1440 | | | |
| | 16:9 mode(25fps mode) | 1920x1080 1280x720 | 1920x1080 1280x720 | 1280x720 640x360 320x180 | 1280x720 640x360 320x180 | |
| | 16:9 mode(60fps mode) | 3072x1728 2560x1440 | -- (Without function) | -- (Without function) | -- (Without function) | |
| | 16:9 mode(50fps mode) | | | | | |
| | 4:3 mode(30fps mode) | 3072x2304 | 3072x2304 | | | |
| | 4:3 mode(25fps mode) | 2560x1920 1280x960 | 2560x1920 1280x960 | 800x600 VGA 400x300 QVGA | VGA QVGA | |
| | 4:3 mode(60fps mode) | 3072x2304 | -- | -- | -- | |
| | 4:3 mode(50fps mode) | 2560x1920 | (Without function) | (Without function) | (Without function) | |
| | New X Fixed Cameras (Image capture size: mode) | 16:9 mode(30fps mode) | 3328x1872 2560x1440 | 3328x1872 2560x1440 | | |
| | | | | | | |

9 [Image/Audio] for setting images and sound files

9.3 [Image] for setting up streams

| | | | | | |
|-----------------------------------------------------|------------------------------------------------|------------------------|---------------------------------------------|--------------------------------|--------------------------------|
| 6MP) | 16:9 mode(25fps mode) | 1920x1080 1280x720 | 1920x1080 1280x720 640x360 320x180 | 1280x720 640x360 320x180 | 1280x720 640x360 320x180 |
| | 16:9 mode(60fps mode) 16:9 mode(50fps mode) | 3328x1872 2560x1440 | -- (Without function) | -- (Without function) | -- (Without function) |
| New X Fixed Cameras (Image capture size: 8MP) | 16:9 mode(30fps mode) | 3840x2160 2560x1440 | 3840x2160 2560x1440 | | |
| | 16:9 mode(25fps mode) | 1920x1080 1280x720 | 1920x1080 1280x720 640x360 320x180 | 1280x720 640x360 320x180 | 1280x720 640x360 320x180 |
| | 16:9 mode(60fps mode) 16:9 mode(50fps mode) | 3840x2160 3840x2160 | -- (Without function) | -- (Without function) | -- (Without function) |

Compact Dome camera (X series) and Compact Dome camera (S series)

| Aircraft type | Image capture mode | H.265/H.264 | | | |
|------------------------------------------------------------------|----------------------------------------|------------------------------------|--------------------------------|--------------------|-----------------------------|
| | | Stream 1 | Stream 2 | Stream 3 | Stream 4 |
| Compact Dome cameras (X/S Series, Image capture size: 4MP) | 16:9 mode (2688x1520 30fps mode) | 2688x1520 1920x1080 1280x720 | 1920x1080 1280x720 | | -- (Without function) |
| | 16:9 mode (2688x1520 25fps mode) | | 640x360 320x180 | 640x360 320x180 | |
| | 16:9 mode(30fps mode) | 2560x1440 1920x1080 | 1920x1080 | | |
| | 16:9 mode(25fps mode) | 1280x720 | 1280x720 640x360 320x180 | 640x360 320x180 | |
| | 4:3 mode(30fps mode) | 1280x960 | 1280x960 | | |
| | 4:3 mode(25fps mode) | 640x480 320x240 | 640x480 320x240 | 640x480 320x240 | |

| | | | | | |
|------------------------------------------------------------------|------------------------|-----------|-----------|----------|---------|
| | 4:3 mode(15fps mode) | 2048x1536 | | | |
| | 4:3 mode(12.5fps mode) | | 1280x960 | 640x480 | 640x480 |
| | | | 640x480 | 320x240 | 320x240 |
| Compact Dome cameras (X/S Series, Image capture size: 2MP) | 16:9 mode(60fps mode) | 1920x1080 | 1920x1080 | 1280x720 | |
| | | 1280x720 | 1280x720 | 1280x720 | |
| | 16:9 mode(50fps mode) | 640x360 | 640x360 | 640x360 | 640x360 |
| | | 320x180 | 320x180 | 320x180 | 320x180 |
| | 16:9 mode(30fps mode) | 1920x1080 | 1920x1080 | 1280x720 | |
| | | 1280x720 | 1280x720 | 1280x720 | |
| | 16:9 mode(25fps mode) | 640x360 | 640x360 | 640x360 | 640x360 |
| | 320x180 | 320x180 | 320x180 | 320x180 | |
| | 4:3 mode(30fps mode) | 1280x960 | 1280x960 | | |
| | 4:3 mode(25fps mode) | 640x480 | 640x480 | 640x480 | 640x360 |
| | | 320x240 | 320x240 | 320x240 | 320x180 |
| | 4:3 mode(15fps mode) | 2048x1536 | | | |
| | 4:3 mode(12.5fps mode) | | 1280x960 | 640x480 | 640x480 |
| | | | 640x480 | 320x240 | 320x240 |
| | | | 320x240 | 320x240 | 320x240 |

Compact Dome camera (U series)

| Aircraft type | Image capture mode | H.265/H.264 | | | |
|----------------------------------------------------------------|-------------------------------------|-------------|--------------------|--------------------|--------------------|
| | | Stream 1 | Stream 2 | Stream 3 | Stream 4 |
| Compact Dome cameras (U Series, Image capture size: 4MP) | 16:9 mode (2688x1520 30fps mode) | 2688x1520 | -- | -- | -- |
| | | 1920x1080 | (Without function) | (Without function) | (Without function) |
| | 16:9 mode (2688x1520 25fps mode) | 1280x720 | | | |
| | | 2560x1440 | | | |
| | 16:9 mode(30fps mode) | 1920x1080 | 1920x1080 | | |
| | 16:9 mode(25fps mode) | 1280x720 | 1280x720 | 640x360 | 640x360 |
| | | | 640x360 | 320x180 | 320x180 |
| | | | 320x180 | 320x180 | |

9 [Image/Audio] for setting images and sound files

9.3 [Image] for setting up streams

| | | | | | |
|-------------------------------------------------------------|------------------------|-----------------------|--------------------------------|--------------------|--------------------|
| | 4:3 mode(30fps mode) | 1280x960 | 1280x960 | | |
| | 4:3 mode(25fps mode) | 640x480 320x240 | 640x480 320x240 | 640x480 320x240 | |
| | 4:3 mode(15fps mode) | 2048x1536 | | | |
| | 4:3 mode(12.5fps mode) | | 1280x960 640x480 320x240 | 640x480 320x240 | |
| Compact Dome cameras (U Series, Image capture size: 2MP) | 16:9 mode(30fps mode) | 1920x1080 1280x720 | 1920x1080 1280x720 | 1280x720 | |
| | 16:9 mode(25fps mode) | 640x360 320x180 | 640x360 320x180 | 640x360 320x180 | 640x360 320x180 |
| | 4:3 mode(30fps mode) | 1280x960 | 1280x960 | | |
| | 4:3 mode(25fps mode) | 640x480 320x240 | 640x480 320x240 | 640x480 320x240 | 640x360 320x180 |
| | | | | | |
| | | | | | |

Corner cameras

| Aircraft type | Image capture mode | H.265/H.264 | | | |
|----------------|------------------------------------------------|---------------------|--------------------|--------------------|--------------------|
| | | Stream 1 | Stream 2 | Stream 3 | Stream 4 |
| Corner cameras | 16:9 mode(30fps mode) 16:9 mode(25fps mode) | 3072x1728 | 3072x1728 | | |
| | | 2560x1440 | 2560x1440 | | |
| | | 1920x1080 | 1280x720 | 1280x720 | 1280x720 |
| | | 640x360 320x180 | 640x360 320x180 | 640x360 320x180 | 640x360 320x180 |
| | 4:3 mode(30fps mode) 4:3 mode(25fps mode) | 3072x2304 | 3072x2304 | | |
| | | 2560x1920 | 2560x1920 | | |
| | | 1280x960 800x600 | VGA | VGA | VGA |
| | | 400x300 QVGA | 400x300 QVGA | QVGA | QVGA |

PTZ cameras

| Aircraft type | Image capture mode | H.265/H.264 | | | |
|---------------|--------------------|-------------|----------|----------|----------|
| | | Stream 1 | Stream 2 | Stream 3 | Stream 4 |
| | | | | | |

| | | | | | |
|----------------------------------------------------------------------------------------------------------------------------------|-----------------------|-------------|-------------|-------------|-------------|
| Rapid PTZ camera (X/S series, Image capture size: 2MP), Multi-directional + PTZ (PTZ part) | 16:9 mode(30fps mode) | 1920x1080 | 1920x1080 | | |
| | 16:9 mode(25fps mode) | 1280x720 | 1280x720 | 1280x720 | |
| | 16:9 mode(60fps mode) | 640x360 | 640x360 | 640x360 | 640x360 |
| | 16:9 mode(50fps mode) | 320x180 | 320x180 | 320x180 | 320x180 |
| | 4:3 mode(30fps mode) | 1280x960 | 1280x960 | | |
| | 4:3 mode(25fps mode) | VGA QVGA | VGA QVGA | VGA QVGA | VGA QVGA |
| Rapid PTZ Camera(X/S Series, Image capture size: 8M (4K)), Indoor PTZ cameras (Image capture size: 8M (4K)) | 16:9 mode(30fps mode) | 3840x2160 | 3840x2160 | | |
| | 16:9 mode(25fps mode) | 2560x1440 | 2560x1440 | | |
| | | | 1920x1080 | | |
| | | | 1280x720 | 1280x720 | 1280x720 |
| | | | 640x360 | 640x360 | 640x360 |
| | | | 320x180 | 320x180 | 320x180 |
| Rapid PTZ Camera(X/S Series, Image capture size: 6MP), Indoor PTZ cameras (Image capture size: 6MP) | 16:9 mode(30fps mode) | 3328x1872 | 3328x1872 | | |
| | 16:9 mode(25fps mode) | 2560x1440 | 2560x1440 | | |
| | | | 1920x1080 | | |
| | | | 1280x720 | 1280x720 | 1280x720 |
| | | | 640x360 | 640x360 | 640x360 |
| | | | 320x180 | 320x180 | 320x180 |

Multi-directional camera

| Aircraft type | Imaging mode | H.265/H.264 | | | |
|---------------------------------------------------------|------------------------------------------|-------------------------------------|--------------------------------|-----------------------|-----------------------|
| | | Stream 1 | Stream 2 | Stream 3 | Stream 4 |
| Multi-directional cameras (8-megapixel models) | 8 megapixels [16:9](15 fps mode) | 3840x2160 2560x1440 1920x1080 | | --- | --- |
| | 8 megapixels [16:9](12.5 fps mode) | | 1280x720 640x360 320x180 | (Without function) | (Without function) |
| | 8 megapixels [16:9](15 fps Dual mode) | 3840x2160 2560x1440 | | | |

| | | | | | |
|----------------------------------------------|------------------------------------------------------------------------------|-------------------------------------|--------------------------------|--|--|
| | 8 megapixels [16:9](12.5 fps Dual mode) | 1920x1080 | 1280x720 640x360 320x180 | | |
| Multi-directional camera (5-megapixel model) | 5 megapixels [16:9](15fps mode) | 3072x1728 2560x1440 | | | |
| | 5 megapixels [16:9](12.5fps mode) | 1920x1080 | 1280x720 640x360 320x180 | | |
| | 5 megapixels [16:9](15fps Quad mode) | 3072x1728 2560x1440 | | | |
| | 5 megapixels [16:9](12.5fps Quad mode) | 1920x1080 | 1280x720 640x360 | | |
| | 5 megapixels [4:3](15fps mode) 5 megapixels [4:3](12.5fps mode) | 3072x2304 2560x1920 | 1280x960 VGA QVGA | | |
| Multi-directional camera (4-megapixel model) | 5 megapixels [4:3](15fps Quad mode) 5 megapixels [4:3](12.5fps Quad mode) | 3072x2304 2560x1920 1920x1080 | 1280x960 640x480 | | |
| | 4 mega pixel [16:9](30fps mode) | 2688x1520 2560x1440 | | | |
| | 4 mega pixel [16:9](25fps mode) | 1920x1080 1280x720 | 1280x720 640x360 320x180 | | |
| | 4 mega pixel [16:9](30fps Dual mode) | 2688x1520 2560x1440 | | | |
| | 4 mega pixel [16:9](25fps Dual mode) | 1920x1080 1280x720 | 1280x720 640x360 | | |



[Note:]

- If [Image rotation] is set to [90°] or [270°] on the [Basic] tabs of the basic pages, the resolution [320x180] cannot be set.
- [New X Fixed]Image capture size [320x180] can be set even if [Image rotation] is set to [90°] or [270°] on [Basic] tab. of the basic page.
- [MULTI] This setting is common to all cameras.
- [MULTI2] When Stream (1) is 2688x1520 and Stream (2) is 1280x720, the frame rate is limited to a maximum of 15fps (maximum 12.5fps in 25fps mode).

[Transmission priority]

Set the stream delivery mode from the following.

- **[Constant bit rate]:**The H.265 (or H.264) images are delivered at the bit rate set by [Max bit rate (per client) *].
- **[VBR]:**The H.265 (or H.264) images are delivered at the frame rate set by [Frame rate*] while maintaining the image quality level set by [Image quality]. At this time, the bit rate is varied within the maximum bit rate set by [Max bit rate (per client) *]. The recording capacity varies depending on the [Image quality] settings and subject conditions.
- **[Frame rate]**Deliver H.265 (or H.264) images at the frame rate set by [Frame rate*].
- **[Best effort]**The H.265 (or H.264) images are delivered with varying bit rates within the maximum bit rate set by [Max bit rate (per client) *], depending on the bandwidth of the networks.



[Note:]

- Setting [Transmission priority] to [Frame rate] may result in fewer users being able to connect.
- [MULTI] This setting is common to all cameras.

[Frame rate*]

Set the frame rate from the following.

-For [16:9 mode(30fps mode)]/[16:9 mode(60fps mode)]/[4:3 mode(30fps mode)]/[4:3 mode(15fps mode)]:

1fps/ 3fps/ 5fps/ 7.5fps/ 10fps/ 12fps/ 15fps/ 20fps/ 30fps/ 60fps

-For [16:9 mode(25fps mode)]/[16:9 mode(50fps mode)]/[4:3 mode(25fps mode)]/[4:3 mode(12.5fps mode)]:

1fps/ 3.1fps/ 4.2fps/ 6.25fps/ 8.3fps/ 12.5fps/ 20fps/ 25fps/ 50fps



[Note:]

- [Frame rate*] is restricted to [Max bit rate (per client) *]. When a value with [*] is set, the frame rate may be lower than the set value. If [Transmission priority] is set to [VBR], the image may be suspended periodically depending on the [Max bit rate (per client) *] and [Image quality] settings. Confirm the image delivered after setting.
- The [*] option is omitted.
- The frame rate up to the value of the selected imaging mode can be selected.
- Depending on the number of concurrent users or the combination of functions used, the frame rate may be lower than the set value. Confirm the image delivered after setting.
- If the frame rate is set low, the image may not be displayed properly depending on the web browser you use.
- 60 fps can be selected only when [Image capture mode] is in [16:9 mode (60 fps mode)]. In this case, stream (1) will be [fixed at 60 fps]. [Stream(2)] ~ [Stream(4)] can be up to 10 fps.
- 50 fps can be selected only when [Image capture mode] is in [16:9 mode (50 fps mode)]. In this case, stream (1) is set to [Fix 50fps]. [Stream(2)] ~ [Stream(4)] can be up to 8.3 fps.
- [MULTI] This setting is common to all cameras.
- [New X Fixed-8M][New X Fixed-6M]60fps can be selected only when [Image capture mode] is set to [16:9 mode(60fps mode)]. In such cases, streaming (1) is set to [60fps fixed]. Also, [Stream(2)] ~ [Stream(4)] will be unavailable.
- [New X Fixed-8M][New X Fixed-6M]50fps can be selected only when [Image capture mode] is set to [16:9 mode(50fps mode)]. In such cases, streaming (1) is set to [50fps fixed]. Also, [Stream(2)] ~ [Stream(4)] will be unavailable.
- [New X Fixed-5M]60fps can be selected only when [Image capture mode] is set to [16:9 mode(60fps mode)] [4:3 mode (60fps mode)]. In such cases, streaming (1) is set to [60fps fixed]. Also, [Stream(2)] ~ [Stream(4)] will be unavailable.
- [New X Fixed-5M]50fps can be selected only when [Image capture mode] is set to [16:9 mode(50fps mode)] [4:3 mode (50fps mode)]. In such cases, streaming (1) is set to [50fps fixed]. Also, [Stream(2)] ~ [Stream(4)] will be unavailable.
- [New X Fixed-2M][New X Fixed-5M]60fps can be selected only when [Image capture mode] is set to [16:9 mode(60fps mode)] [4:3 mode (60fps mode)]. In such cases, streaming (1) is set to [60fps fixed].
- [New X Fixed-2M][New X Fixed-5M]50fps can be selected only when [Image

capture mode] is set to [16:9 mode(50fps mode)] [4:3 mode (50fps mode)]. In such cases, streaming (1) is set to [50fps fixed].

[Max bit rate (per client) *]

Select H.265 (or H.264) bit rate for one client from the following.

64kbps/128kbps */ 256kbps */ 384kbps */ 512kbps */ 768kbps */ 1024kbps */ 1536kbps */
2048kbps */ 3072kbps */ 4096kbps */ 6144kbps */ 8192kbps */ 10240kbps */ 12288kbps */
14336kbps */ 16384kbps */ 20480kbps */ 24576kbps */---free input

If [-----] is selected, the bitrate can be entered freely to the extent that it can be set.

If [Transmission priority] is [Constant bit rate], [Frame rate], or [Best effort]

320x180, 640x360, QVGA, 400x300, VGA, 800x600: 64 kbps to 4096 kbps *

1280x720*¹For 1280 x 960: 128 kbps *~ 8192 kbps *

1920x1080*¹For: 256 kbps *~ 12288 kbps *

For 2048 x 1536*¹: 512 kbps *~ 16384 kbps *

For 2560 x 1440, 2560 x 1920: 768 kbps *~ 24576 kbps *

For 3072 x 1728: 1024 kbps *~ 24576 kbps *

For 3072 x 2304: 1536 kbps *~ 24576 kbps *

3840 x 2160 : 2048 kbps *~ 24576 kbps *

When [Transmission priority] is [VBR]

320x180, 640x360, QVGA, 400x300, VGA, 800x600: 64 kbps to 12288 kbps *

1280x720*¹For 1280 x 960: 128 kbps *~ 12288 kbps *

1920x1080*¹In the case: 256 kbps *~ 24576 kbps *

For 2048 x 1536: 512 kbps *~ 24576 kbps *

For 2560 x 1440, 2560 x 1920: 768 kbps *~ 24576 kbps *

For 2688 x 1520: 768 kbps to 24576 kbps

For 3072 x 1728: 1024 kbps *~ 24576 kbps *

For 3072 x 2304: 1536 kbps *~ 24576 kbps *

For 3840 x 2160: 2048 kbps *~ 24576 kbps *



[Note:]

- Refer to the catalog specifications for resolutions that can be selected for each model.
- The bit rate of streams is restricted to [Bandwidth control(bit rate)] on the [Network] tabs of network pages. Therefore, when the value with [*] is set, the image may not be delivered.

→14.1 Networking [Network]

- It is recommended that the bit rate of the stream be set to 8192 kbps or less. If a value greater than 8192 kbps is set, the continuity of recorded images may be abnormal.
- When the refresh interval is short, the bit rate may be exceeded depending on the subject.
- Depending on the number of concurrent users or the combination of functions used, the bit rate may be lower than the set value. Confirm the image delivered after setting.
- If you use [60fps mode] or [50fps mode] at the resolution of *1, you can set up to 24576 kbps.
- [MULTI] This setting is common to all cameras.

[Image quality]

Select the image quality for the H.265 (or H.264) image from the following.

For [Constant bit rate], [Frame rate], [Best effort]: Movement priority/Standard/Image quality priority

For [VBR]: [0 maximum image quality]/[1 Fine]/2/3/4/[5 Normal]/6/7/8/[9 Low]

Smart Coding-[Auto VIQS]

Images are distributed so that the quality of images in moving places is high and the amount of data in other places is low.

[Off]: Auto VIQS is not used.

[On]: It keeps the image quality in the moving place high and reduces the amount of data in other places.

Smart Coding-[Smart VIQS]

Images are distributed so that the amount of data decreases while maintaining high image quality in areas with objects (head, people, cars and motorcycles) and low/medium/medium image quality in other areas.

[Off]: Do not use smart VIQS.

[On(High)]: Images are distributed so that the image quality in the area where the object (head, people, automobiles, and motorcycles) is located is maintained at a high level, while the image quality in other areas is maintained at a low level and the amount of data is reduced.

[On(Low)]: Images are distributed so that image quality is high in areas with objects (head, people, cars, and motorcycles) and medium image quality is maintained in other areas while data volume is low.



[Note:]

- This function can be used with [Stream(1)] only. If [On(High)] or [On(Low)] is selected, the VIQS settings are disabled from the [Image quality] tabs.
- [MULTI4] [MULTI3] When [Smart VIQS] is set to [On(High)] or [On(Low)], the frame rate is limited to 7.5 fps maximum in 15 fps mode, 6.25 fps maximum in 12.5 fps mode, 15 fps maximum in 30 fps mode, and 12.5 fps maximum in 25 fps mode.
- [New X Fixed-8M][New X Fixed-6M][New X Fixed-5M]If [Image capture mode] is set to [60fps Mode] or [50fps Mode], [Smart VIQS] cannot be used.

Smart Coding-[Smart P-picture control]

To reduce the amount of data, control the generation of data (macroblock) as little as possible except where there is an object (head, person, car, or motorcycle).

[Off]: Smart P picture control is not used.

[On]: In order to reduce the amount of data, P-picture data is controlled to be generated as little as possible in areas other than those with an object (head, person, car, or motorcycle).



[Note:]

- This function can be used with [Stream(1)] only. If [On] is selected, the VIQS settings are disabled from the [Image quality] tabs.
- When [On] is selected, movement may not be smooth or noise may be generated in areas without objects (heads, people, cars, and motorcycles).
- [MULTI4] [MULTI3] When [Smart P-picture control] is set to [On], the frame rate is limited to 7.5 fps maximum in 15 fps mode, 6.25 fps maximum in 12.5 fps mode, 15 fps maximum in 30 fps mode, and 12.5 fps maximum in 25 fps mode.
- [New X Fixed-8M][New X Fixed-6M][New X Fixed-5M]If [Image capture mode] is set to [60fps Mode] or [50fps Mode], [Smart P-picture control] cannot be used.

Smart Coding-[GOP control]

The GOP control reduces the amount of data.

If [H.265] is selected in [Stream encoding format]: [Off]/Low/Mid/Advanced/Frame rate control

If [H.264] is selected in [Stream encoding format]: [Off]/[Low]/[Mid(variable GOP 4s-16s)]



[Important]

- When [Low], [Mid], [Mid], or [Frame rate control (Variable GOP4s-16s + Frame rate control)] is selected, recording cannot be performed on the SD Memory Card. If Advanced (fixed GOP 60s + 1s keyframe) is selected, the data can be recorded on SD cards only with [Manual] [Schedule].

**[Note:]**

- Using GOP control increases the refresh interval for the H.265 (or H.264) image. Therefore, do not use in network environments where there are many errors.
- [Low]/[Mid]/[Frame rate control (variable GOP4s-16s + frame rate control)] can be set only when [VBR] is selected in [Transmission priority]. [Advanced (Fixed GOP 60s + 1s keyframe)] can be set regardless of the [Transmission priority].
- [Low (variable GOP 1s-8s)], [Mid (variable GOP 4s-16s)], and [Frame rate control (variable GOP 4s-16s + frame rate control)] can reduce the amount of data when there is no detectable object (face, person, car, or motorcycle) in the image. [Advanced (fixed GOP 60s + 1s keyframe)] reduces the amount of data regardless of the presence or absence of the sensing object.
- When [Frame rate control] is set, the frame rate can be changed from 1fps to [Frame rate*] depending on the presence or absence of the sensing object.
- When [Frame rate control] is set, the display may temporarily slow or fast when the frame rate is switched.
- [MULTI] When [GOP control] is set to [Low(Variable GOP 1s-8s)], [Mid (Variable GOP 4s-16s)], [Advanced(Fixed GOP 60s w/1s key-frame)] or [Frame rate control(Variable GOP 4s-16s w/frame rate control)] is selected, the bit rate will be limited.
- [MULTI4] [MULTI3] [GOP control] is set to [Low(Variable GOP 1s-8s)], [Mid(Variable GOP 4s-16s)] or [Frame rate control(Variable GOP 4s-16s w/frame rate control)], the frame rate is limited to 7.5 fps maximum in 15 fps mode, 6.25 fps maximum in 12.5 fps mode, 15 fps maximum in 30 fps mode, and 12.5 fps maximum in 25 fps mode.
- [New X Fixed-8M][New X Fixed-6M][New X Fixed-5M]If [Image capture mode] is set to [60fps Mode] or [50fps Mode], [GOP control] cannot be used.

[Refresh interval]

Select the refresh interval (I-Picture interval: 0.2 to 5 seconds) for the H.265 (or H.264) image from the following.

If there are many errors in the network environment, the image will be less distorted if the refresh interval is shortened.

However, the updating speed of the image may decrease or the bit rate may be exceeded.

[0.2s]/ [0.25s]/ [0.33s]/ [0.5s]/ [1s]/ [2s]/ [3s]/ [4s]/ [5s]



[Note:]

- If [GOP control] is set to Low (variable GOP 1s–8s), the refresh interval is set to 8s.
- If [GOP control] is set to Mid (variable GOP 4s–16s), the refresh interval is set to 16s.
- If [GOP control] is set to Advanced (fixed GOP 60s + 1s keyframe), the refresh interval is set to 60s.
- If [GOP control] is set to [Frame Rate Control (variable GOP 4s–16s + frame rate control)], the frame rate can be varied between values set from 1fps to [Frame rate*] according to the magnitude of the image change. The lower the frame rate, the longer the refresh interval. The maximum refresh interval is 16s.
- [MULTI] This setting is common to all cameras.

[Transmission type]

Select the distribution method of H.265 (or H.264) image from the following.

[Unicast port (AUTO)]:

When sending images and sounds from your computer, [Unicast port1(Image)] and [Unicast port2(Audio)] are automatically set. If you do not need to fix the number of the ports on which the streams are delivered, such as when used in networks, it is recommended that you set it to [Unicast port (AUTO)].

[Unicast port (MANUAL)]:

When sending images and audio from the computer, the [Unicast port1(Image)] and [Unicast port2(Audio)] must be set manually. When accessing a camera using a browser, the port number is automatically selected even in this setting. When distributing a stream over the Internet, fix the port number to be used as the Broadband Router (hereinafter referred to as the Router). For details, refer to the router's instruction manual.

→[14.1 Networking \[Network\]](#)

[Multicast]:

You can access this machine at the same time without restricting the number of people. To send streams in multicast, enter [Multicast address], [Multicast port], and [Multicast TTL/HOPLimit].



[Note:]

- For the maximum number of simultaneous unicast accesses, see the following.
→[2.3.1 View camera images](#)
- If [Unicast port (MANUAL)] is selected, you must configure a unicast port number.
- When multicast is set, the browser will not be able to view the H.265 image (or

H.264 image).

- If [Multicast] is selected, you must configure multicast IP addresses.
- [MULTI] This setting is common to all cameras.

[Unicast port1(Image)]

Enter the unicast port number (used to send images from your computer).

Configurable port number:1024 to 50000 (even number only)

[Unicast port2(Audio)]

Enter the unicast port number (to be used when sending audio from your computer).

Configurable port number:1024 to 50000 (even number only)

[Multicast address]

Enter the multicast IP address.

Send images and sound to the specified IP address.

IPv4 configurable range:224.0.0.0~239.255.255.255

IPv6 configurable range:Multicast addresses starting with FF



[Note:]

- Check and enter the available multicast IP address.

[Multicast port]

Enter the multicast port number (used when sending images from your computer).

Configurable port number:1024 to 50000 (even number only)



[Note:]

- When sending audio from your computer, the multicast port number plus [1000] is used.

[Multicast TTL/HOPLimit]

Enter the TTL/HOPLimit value for the multicast.

Settable value:1~254



[Important]

- When delivering a stream over the Internet, the distribution image may not be displayed depending on the settings of the proxy server, firewall, etc. In this case, contact your network administrator.

- If you want to display multicast images using a PC with multiple LAN cards, disable LAN cards that are not used for reception.

9.4 [Image quality] to set the image quality

Click on the [Image quality] tabs of the video and audio pages. Refer to the following how to display and operate the Advanced menu.

→[5.1 How to display](#)

→[5.2 How to operate](#)

To Advanced Settings for each item>>Clicking this button displays the advanced settings window in a separate window and allows you to set the settings while viewing the images displayed on the [Image quality] tab.

You can set the image quality adjustment, zoom/focus, privacy zone, VIQS, and lens distortion compensation.

- 9 [Image/Audio] for setting images and sound files
 - 9.4 [Image quality] to set the image quality
-

Image **Image quality**



Cam. 1 ▾

| | |
|------------------------------|----------|
| Image adjust | Setup >> |
| Extra zoom | Setup >> |
| Privacy zone | Setup >> |
| VIQS | Setup >> |
| Lens distortion compensation | Setup >> |

- 9 [Image/Audio] for setting images and sound files
- 9.4 [Image quality] to set the image quality

Image **Image quality** Audio



| | |
|------------------------------|--------------------------------|
| Image adjust | Setup >> |
| Extra optical zoom | Setup >> |
| Privacy zone | Setup >> |
| VIQS | Setup >> |
| Lens distortion compensation | Setup >> |

Image **Image quality** Audio



Left/Right ▾

| | |
|------------------------------|--------------------------------|
| Image adjust | Setup >> |
| Zoom/Focus adjustment | Setup >> |
| Privacy zone | Setup >> |
| VIQS | Setup >> |
| Lens distortion compensation | Setup >> |

Selecting the camera from the pull-down menu at the bottom of the screen displays the live picture of the selected camera. You can view the image quality adjusted on this screen.



[Note:]

- [MULTI] Only Multi-directional cameras can be selected.

[Image adjust]

To Advanced Settings>>When the [button] is clicked, the image quality setting window is displayed in a separate window.

→9.4.1 [To adjust the image quality \(image quality adjustment screen\)](#)

[Image adjust]

To Advanced Settings>>When the [button] is clicked, the image quality setting window is displayed in a separate window.

→9.4.1 [To adjust the image quality \(image quality adjustment screen\)](#)

[Extra zoom]

To Advanced Settings>>When the button is clicked, the EX zoom setting window is displayed in a separate window.

→9.4.3 [Adjust the angle of view with the EX zoom](#)

[Extra optical zoom]

To Advanced Settings>>When the button is clicked, the Ex optical zoom setting window is displayed in a separate window.

→9.4.4 [Adjust the angle of view with the Ex optical zoom](#)

[Zoom/focus adjustment]

To Advanced Settings>>When the button is clicked, the zoom and focus settings window is displayed in a separate window.

→9.4.5 [Adjust the zoom/focus](#)

[Privacy zone]

To Advanced Settings>>Click the [Privacy Zone] button to open the Privacy Zone Settings window.

→9.4.6 [Setting the privacy zone \(Privacy zone setting screen\)](#)

[VIQS]

To Advanced Settings>>Click the [VIQS] button to display the VIQS settings window.

→9.4.7 [Set up VIQS](#)

[Lens distortion compensation]

To Advanced Settings>>Click this button to display the setting window for lens distortion

compensation in a separate window.

→9.4.9 Set the lens distortion compensation



[Note:]

- Items displayed differ depending on the model. Refer to the catalog specifications for the functions installed in each model.
- [PTZ] See the following for the operation of the zoom function of the PTZ camera.
→10.1 [Cam. Function] for setting the operation of cameras

9.4.1 To adjust the image quality (image quality adjustment screen)

In the Video/Audio [Image quality] tabs to [Image adjust] Advanced Settings>>Click the [Button].

→9.4 [Image quality] to set the image quality

Image quality is set in the setting screen displayed in a separate window. When you change the values, the images displayed on the [Image quality] tabs also reflect the changes.

Click + on the left side of each item in the setting screen to expand each item and display detailed settings.

Click-> on the left of each expanded item to return to the previous window.

<Example: Basic image quality adjustment>

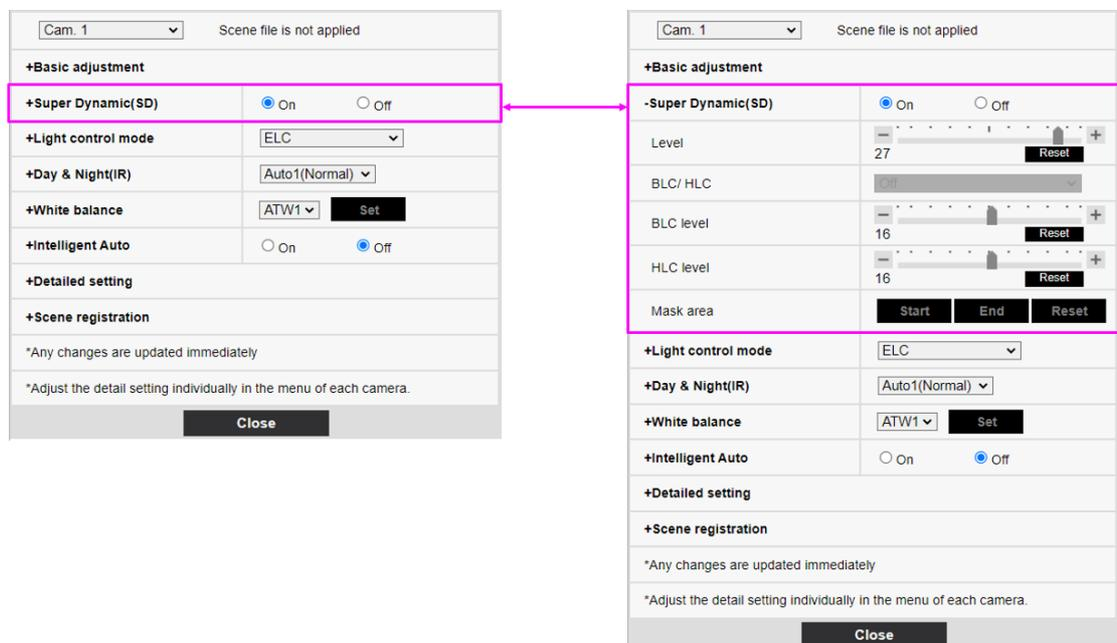

[Camera selection]

Select the camera that reflects the image quality settings.

[Common(Cam. 1-2)]:The settings are made simultaneously for each camera. The images

displayed on the [Image quality] tabs are divided into cameras.

[Camera 1]: Sets camera 1 image quality. The image displayed on the [Image quality] tab is the camera-1 image.

[Camera 2]: Sets camera 2 image quality. The image displayed on the [Image quality] tab is camera-2 image.

[Camera 3]: Set the image quality of camera 3. The image displayed on the [Image quality] tab is the camera-3 image.

[Camera 4]: Set the image quality of camera 4. The image displayed on the [Image quality] tab is the camera 4 image.



[Note:]

- [MULTI] [Camera selection] can be selected only for Multi-directional cameras.
- [MULTI] For [Common(Cam. 1-2)], for [Super Dynamic], [Light control mode], [White balance], and Intelligence Auto, only items can be set up prior to the advanced settings. To perform other advanced settings, select each camera.

Basic image quality adjustment

[Brightness]

Adjust the brightness.

Move the slider bar in the [+] direction to brighten the image.

Move the slider bar in the [-] direction to darken the image.

Press [Reset] to return to the default brightness.

[Maximum gain]

Adjust the maximum gain. When the subject's illumination becomes dark, the gain automatically increases and the screen brightens.

Increasing the gain may increase the noise.

Move the slider bar in the [+] direction to increase the maximum gain.

Move the slider bar in the [-] direction to reduce the maximum gain.

Press [Reset] to return to the default settings.

[Chroma gain level]

Adjust the chroma level (color intensity).

When the slider bar is moved in the [+] direction, it becomes bright and bright.

When the slider bar is moved in the [-] direction, the color becomes calm.

Press [Reset] to return to the default settings.

[Sharpness level]

Adjust the sharpness level (contour correction).

Moving the slider bar in the direction of [+] results in a sharp contour, while moving the slider bar

in the direction of [-] results in a soft contour.

Press [Reset] to return to the default settings.

[Digital noise reduction]

The digital noise reduction function automatically reduces noise at low illumination levels.

Move the slider bar in the direction of [+] to increase the effect of noise reduction. For more afterimages

I have one.

Moving the slider bar in the direction of [-] reduces the noise reduction effect. There are fewer aftereffects.

Press [Reset] to return to the default settings.

Superdynamic

[Super Dynamic]

You can set [On] or [Off] to activate the super dynamic function.

See [What is Super Dynamic] for details on super dynamic.

[On]:The Super Dynamic function is activated.

[Off]:Stops the superdynamic function.



[Note:]

- This cannot be set when [Image capture mode] is [16:9 mode(60fps mode)] or [16:9 mode(50fps mode)].
- Set [Super Dynamic] to [Off] when the following phenomena are observed depending on the lighting condition.
 - when flickering or color changes occur
 - when noise is generated in the bright area of the screen
- If [Light control mode] is set to [Fix shutter], [Super Dynamic] cannot be set to [On].
- When [Stabilizer] is set to [On], the superdynamic setting is [Off].

[Level]

Adjust the superdynamic level.

When the slider bar is moved in the [+] direction, you can shoot a subject with a large difference in light and darkness without flipping white or shading black.

Move the slider bar in the [-] direction to take a full picture of the middle brightness.

Press [Reset] to return to the default settings.

What is Superdynamic?

If there is a large difference between the bright and dark areas, the camera will set the lens aperture to match the bright areas, making the dark areas invisible. Conversely, when the lens

aperture is adjusted to the dark area, the bright area is not visible.

Super Dynamic is a function of combining images with large brightness and darkness, and images with large darkness, and reproducing brightness and darkness faithfully.

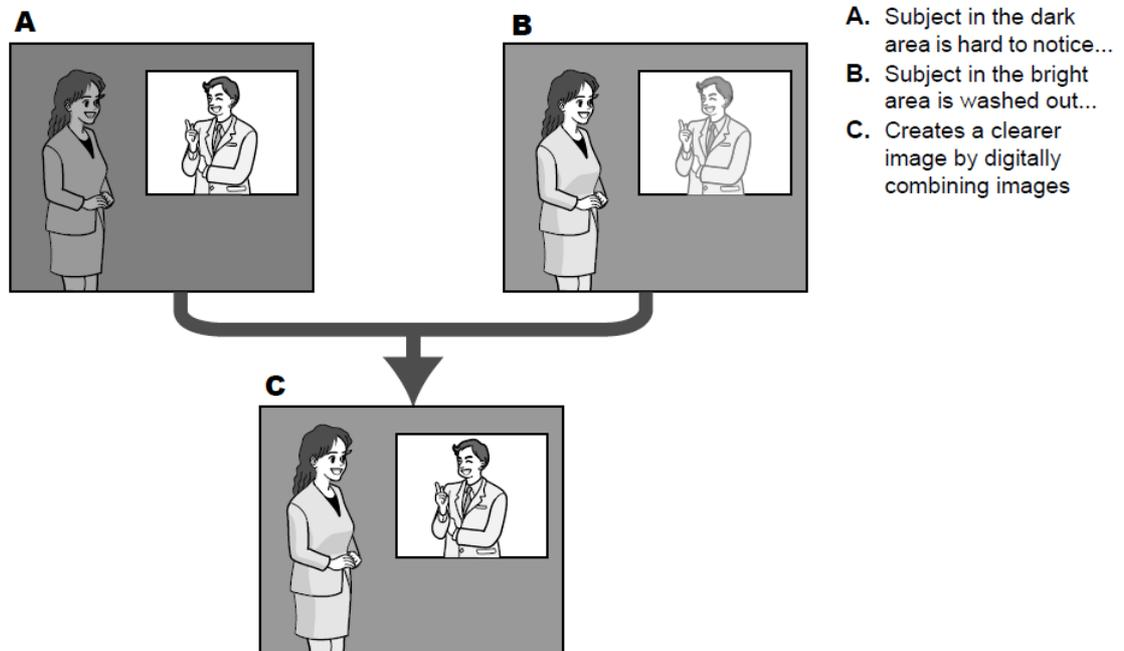

[Note:]

• [New X Fixed-8MP][New X Fixed-6MP][New X Fixed-5MP] If [Level] is set to 30 or higher, [Frame Rate] is limited to the highest 15fps.

[BLC/ HLC]

Select from the following. This setting is not available if [Super Dynamic] is set to [On] or [Intelligent Auto] is set to [On].

[Back light compensation(BLC)]: Enables the backlight correction function.

[High light compensation(HLC)]: Enables the high light correction function. Illumination compensation suppresses bright lighting of subjects such as car headlights during nighttime.

[Off]: Stops the backlight compensation function and the intense light correction function.

[BLC level]

Adjust the backlight correction level.

Moving the slider bar in the [+] direction improves the backlight correction effect. Moving the slider bar in the [-] direction reduces the effect of backlight correction.

Press [Reset] to return to the default settings.

[HLC level]

Adjust the intensity correction level.

Moving the slider bar in the [+] direction improves the effect of intense light correction. Moving the slider bar in the [-] direction reduces the effect of intense light correction.

Press [Reset] to return to the default settings.

[Mask area]

When the mask area is set, the set area can be masked and the light intensity can be adjusted. If [Super Dynamic] is set to [On], it cannot be set.

For details on how to set the mask area, refer to the following.

→9.4.2 [Set the mask area](#)



[Note:]

- [MULTI] When [Common(Cam. 1-2)] is selected in [Camera selection], the mask area cannot be set. Set for each camera.

Light intensity control mode

[Light control mode]

Select the mode to control the light intensity from the following.

[Outdoor scene]: The brightness (illumination) controls the light intensity by combining the electronic shutter and automatic aperture. This setting is used when shooting bright subjects such as outdoors. Be careful not to flicker under fluorescent lights, etc.

[Flickless (50 Hz)]/[Flickless (60 Hz)]: Flicker is automatically corrected with a fluorescent lamp. 50 Hz/60 Hz will be used differently in different regions.

ELC: The electronic shutter is used to control the light intensity.

[Fix shutter]:

If [Image capture mode] is [Single source [4:3](30fps mode)]/[Dual sources [4:3](15fps mode)]:
[1/30 fixed], [3/120 fixed], [2/100 fixed], [2/120 fixed], [1/100 fixed], [1/120 fixed], [1/250 fixed], [1/500 fixed], [1/1000 fixed], [1/2000 fixed], [1/4000 fixed], or [1/10000 fixed]

If [Image capture mode] is [Single source [4:3](25fps mode)]/[Dual sources [4:3](12.5fps mode)]:
[1/25 fixed]/[3/100 fixed]/[2/100 fixed]/[1/100 fixed]/[1/250 fixed]/[1/500 fixed]/[1/1000 fixed]/[1/2000 fixed]/[1/4000 fixed]/[1/10000 fixed]

If [Image capture mode] is in [60fps mode]:

[1/60 fixed]/[1/100 fixed]/[1/120 fixed]/[1/250 fixed]/[1/500 fixed]/[1/1000 fixed]/[1/2000 fixed]/[1/4000 fixed]/[1/10000 fixed]

If [Image capture mode] is in [50fps mode]:

[1/50 fixed]/[1/100 fixed]/[1/250 fixed]/[1/500 fixed]/[1/1000 fixed]/[1/2000 fixed]/[1/4000 fixed]/[1/10000 fixed]



[Note:]

- Refer to the catalogue specifications for the [Light control mode] that can be selected for each model.
- If you increase the shutter speed ($\sim 1/10,000$), you will be less prone to blur even when the subject moves faster.
- Increasing the shutter speed decreases the sensitivity.
- If [Super Dynamic] is set to [On], [Fix shutter] cannot be set.
- To configure [Fix shutter], set [Super Dynamic] to [Off].
- If [Image capture mode] is [Single source [4:3](25fps mode)], [50fps mode], or [Dual sources [4:3](12.5fps mode)], [Flickerless 60Hz] cannot be set.
- When [25fps mode], [50fps mode], or [12.5fps mode] is selected for [Image capture mode], [Indoor scene(60 Hz)] is not available.
- It may be able to reduce flickering by switching the [Image capture mode] as follows:
 - In the area where the power frequency is 60Hz: Switch the [Image capture mode] to 30 fps mode or 15 fps mode.
 - In the area where the power frequency is 50Hz: Switch the [Image capture mode] to 25 fps mode or 12.5 fps mode.

[Maximum shutter]

The maximum exposure time adjusts the maximum storage time of the sensor. The following values can be set.

Compact camera, Multi-directional camera, Corner cameras

If [Image capture mode] is in 30 fps or 15 fps mode:

[Maximum 1/10000s]/[Maximum 1/4000s]/[Maximum 1/2000s]/[Maximum 1/1000s]/[Maximum 1/5000s]/[Maximum 1/250s]/[Maximum 1/120s]/[Maximum 2/120s]/[Maximum 2/120s]/[Maximum 2/100s]/[Maximum 3/120s]/[Maximum 1/30s]/[Maximum 2/30s]/[Maximum 4/30s]/[Maximum 6/30s]/[Maximum 10/30s]/[Maximum 16/30s]

If [Image capture mode] is in 25 fps or 12.5 fps mode:

[maximum 1/10000 s]/[maximum 1/4000 s]/[maximum 1/2000 s]/[maximum 1/1000 s]/[maximum 1/500 s]/[maximum 1/250 s]/[maximum 1/100 s]/[maximum 2/100 s]/[maximum 3/100 s]/[maximum 1/25 s]/[maximum 1/25 s]/[maximum 2/25 s]/[maximum 4/25 s]/[maximum 6/25 s]/[maximum 10/25 s]/[maximum 16/25 s]

New X fixed camera

If [Image capture mode] is in 30 fps or 15 fps mode:

[Maximum 1/4000s]/[Maximum 1/2000s]/[Maximum 1/1000s]/[Maximum 1/5000s]/[Maximum 1/250s]/[Maximum 1/120s]/[Maximum 2/120s]/[Maximum 2/120s]/[Maximum 2/100s]/[Maximum 3/120s]/[Maximum 1/30s]/[Maximum 2/30s]/[Maximum 4/30s]/[Maximum 6/30s]/[Maximum 10/30s]/[Maximum 16/30s]

If [Image capture mode] is in 25 fps or 12.5 fps mode:

[maximum 1/4000 s]/[maximum 1/2000 s]/[maximum 1/1000 s]/[maximum 1/500 s]/[maximum 1/250 s]/[maximum 1/100 s]/[maximum 2/100 s]/[maximum 3/100 s]/[maximum 1/25 s]/[maximum 1/25 s]/[maximum 2/25 s]/[maximum 4/25 s]/[maximum 6/25 s]/[maximum 10/25 s]/[maximum 16/25 s]



[Important]

- When [Maximum shutter] is set to the following, the frame rate may decrease when the subject is dark.

If the [Image capture mode] is in 30 fps or 15 fps mode:

Value longer than [1/30s maximum] ([2/30s maximum]/[4/30s maximum]/[6/30s maximum]/[10/30s maximum]/[16/30s maximum])

If the [Image capture mode] is in 25 fps or 12.5 fps mode:

Value longer than [1/25s maximum] ([2/25s maximum]/[4/25s maximum]/[6/25s maximum]/[10/25s maximum]/[16/25s maximum])

- [MULTI] If the frame rate is lowered for one or more cameras due to the above, the frame rate is lowered for the other cameras whose exposure time has not changed.



[Note:]

- Refer to the catalogue specifications for the [Maximum shutter] that can be selected for the respective models.
- If [Super Dynamic] is set to [On], [Maximum 1/2000 s], [Maximum 1/4000 s], or [Maximum 1/10000 s] cannot be set.
- If [Maximum gain] is set to [0], the [Maximum shutter] setting is restricted as follows.

If [Image capture mode] is set to [Single source [4:3](30fps mode)]/[60fps mode]/[Dual sources [4:3](15fps mode)]:

[Maximum 2/30s] or more cannot be set.

If [Image capture mode] is set to [Single source [4:3](25fps mode)]/[50fps mode]/[Dual sources [4:3](12.5fps mode)]:

[Maximum 2/25s] or more cannot be set.

- If [Light control mode] is set to [Flickless (60Hz)], the duration cannot be set to less than [1/120s].
- If [Light control mode] is set to [Flickless (50Hz)], the duration cannot be set to less than [1/100s].

[Light control speed]

Adjust the speed of light intensity adjustment.

Move the slider bar in the [+] direction to increase the speed of light adjustment.

Moving the slider bar in the [-] direction slows the light intensity adjustment speed.

Press [Reset] to return to the default settings.

Switching between black and white

[D&N]

Select the mode for switching between black-and-white and color images.

Model with IR LED light

[Off]: It is always shot with color images.

[On(IR Light Off)]: The picture is always taken in black and white.

[On(IR Light On)]: The picture is always taken in black and white. This setting is used when near-infrared lighting is used at night.

[Auto1(IR Light Off)]: The color image and black-and-white image are automatically switched depending on the brightness (illumination) of the image.

[Auto2(IR Light On)]: The color image and black-and-white image are automatically switched depending on the brightness (illumination) of the image. This setting is used when near-infrared lighting is used at night.

[Auto3(SCC)]: Set this when you want to maintain a color image even when the light source is dark. The Super Chroma Compensation (SCC) function maintains the color image to low brightness.

IR LED lightNo-model

[Off]: It is always shot with color images.

[On]: The picture is always taken in black and white.

[Auto1(Normal)]: The color image and black-and-white image are automatically switched depending on the brightness (illumination) of the image.

[Auto2(IR Light)]: The color image and black-and-white image are automatically switched depending on the brightness (illumination) of the image. This setting is used when near-infrared lighting is used at night.

[Auto3(SCC)]: Set this when you want to maintain a color image even when the light source is dark. The Super Chroma Compensation (SCC) function maintains the color image to low illumination.

What is Super Chroma Compensation (SCC)?

This function enables the acquisition of color images that are faithful using a unique color correction technology even in an environment with low illumination that cannot capture images faithfully.



[Note:]

- Refer to the catalog specifications for the functions installed in each model.
- The Auto3 (Super Chroma Compensation) setting uses color correction techniques and may be displayed differently from the Full object depending on the ambient illumination condition.
- The operation sound may be heard when switching between black and white. However, this is not an error.
- Automatic color/black-and-white image switching may not work depending on the environment. In this case, use the scheduling function to change the color image/black-and-white image. How to set up is our technical information website <Control No. C0314>.
- [MULTI] If [D&N] is set to other than [Off], all cameras will be changed to the same setting.
- [Rapid PTZ][Auto3(SCC)] cannot be selected.

[Level]

Select the brightness (illumination) level to switch between color image and black-and-white image from the following. The following switching illuminance is the illuminance when [Super Dynamic] is [Off].

3:The brightness (brightness) of the camera is about 8 lx or less, and the image is switched to black and white.

2:The brightness (brightness) around the camera is about 4 lx or less, and the camera switches to a black-and-white image.

1:The brightness (brightness) of the camera is about 2 lx or less and the image is switched to black and white.

0:The brightness (brightness) around the camera is about 1 x or less, and the image is switched to black and white.



[Note:]

- The color image switching is about 5 to 8 times bright. It may vary depending on the environment.
- If [Maximum gain] is set low, it may not be easy to switch over depending on the environments.

[Dwell time]

Select the time before switching between color image and black-and-white image from the following.
[2s]/ [10s]/ [30s]/ [1min]

[IR LED light intensity]

Select IR light intensity from [High]/[Middle]/[Low]/[Off].



[Note:]

- Only IR-equipped models can be selected for [IR LED light intensity].
- Refer to the catalog specifications for the functions installed in each model.
- When [Black & white input] is selected in [Terminal 1] of the [Alarm] tab, [Off] can be selected.
- [MULTI] This setting is displayed only when [Camera selection] is set to [Common(Cam. 1-2)]. The settings for each camera are not available.

IR Light individual settings

You can enable or disable each IR Light individually.

For more information, please refer to our technical information website<Control No. C0109>.



[Note:]

- Refer to the catalog specifications for the functions installed in each model.
- [MULTI] [IR Light Individual Setting] can be selected only for the model with IR of the Multi-directional camera.

[Intensity control]

IR Light Sets ON/OFF whether the white and suppression function can be activated.



[Note:]

- Only IR-equipped models can be selected for [IR LED light intensity].
- Refer to the catalog specifications for the selectable switching method for each model.
- When [Intelligent Auto] is [On], [Intensity control] does not work.
- [MULTI] If [IR LED light intensity] is set to other than [Off], all cameras will be changed to the same setting.

White balance

[White balance]

Select the white balance adjustment method from the following.

Adjust the white color with the R volume (adjusting red color) or the B volume (adjusting blue).

[ATW1]:Set the automatic color temperature tracking mode. The camera continuously checks the

color temperature of the light source and automatically adjusts the white balance. The operating range is about 2700 K to 6000 K.

[ATW2]:Set the automatic color temperature tracking mode under sodium lamp. The camera automatically adjusts the white balance under the sodium lamp. The operating range is from about 2000 K to 6000 K.

[AWC]:Set the automatic white balance control mode. Since the light source is fixed, it is suitable for shooting where the light source does not change. The operating range is from approximately 2000 K to 10000 K.



[Note:]

- Colors may not be reproducible faithfully if the following conditions are met: In such cases, set it to [AWC].
 - Most dark-colored subjects
 - The outgoing blue sky and the evening sun
 - Subject with too low illumination
- If [AWC] is selected, press [Set].

[Red gain]

Adjusts the red color of the image.

Move the slider bar in the [+] direction to darken the red color. When the slider bar is moved in the [-] direction, the red color becomes light. Press [Reset] to return to the default settings.

[Blue gain]

Adjust the blue color of the image.

Move the slider bar in the [+] direction to darken the blue color. When the slider bar is moved in the [-] direction, the blue color becomes light. Press [Reset] to return to the default settings.

[Mask area]

When the mask area is set, the set area can be masked and the white balance can be adjusted.

For details on how to set the mask area, refer to the following.

→9.4.2 [Set the mask area](#)



[Note:]

- [MULTI] When [Common(Cam. 1-2)] is selected in [Camera selection], the mask area cannot be set. Set for each camera.

[Adjustment speed]

Adjust the white balance adjustment speed.

Move the slider bar in the [+] direction to increase the white balance adjustment speed. Move the

slider bar in the [-] direction to slow the white balance adjustment speed. Press [Reset] to return to the default settings.

Intelligent auto

[Intelligent Auto]

Set ON/OFF whether the intelligent auto function is enabled or not.

Intelligent Auto identifies scenes (backlights, outdoors, night scenes, etc.), faces, moving objects, etc., and automatically squeezes the camera to adjust the gain, shutter speed, and contrast to make it easier to see faces and moving objects.

What is Intelligent Auto?

This function enables the camera to adjust the gain, shutter speed, and contrast by identifying scenes (backlight, outdoors, night scenes, etc.), faces of people, and moving objects, thereby making it easier to see faces and moving objects.

[Face priority level (Brightness)]

Adjust the face priority level when activating intelligent auto.

Move the slider bar in the [+] direction to make the face more visible.

Move the slider bar in the [-] direction to adjust the entire image in a balanced manner.

Press [Reset] to return to the default settings.

[Motion priority level (Shutter)]

Adjust the motion priority level when activating intelligent auto.

Moving the slider bar in the [+] direction makes moving subjects less prone to blurring but increases dark subject noise.

Moving the slider bar in the [-] direction tends to blur the moving subject but reduces the dark subject noise. Press [Reset] to return to the default settings.



[Note:]

- Flicker caused by fluorescent lamp may occur when intelligent auto is activated. In this case, set one of the following settings.
Adjust the [Motion priority level] slider bar to [-].
Change [Light control mode] to [Indoor scene(50Hz)] or [Indoor scene(60Hz)].
- When intelligent auto is activated, the brightness of the entire image may change due to changes in some subjects. In such cases, adjust the [Face priority level] slider bar to [-].
- [MULTI4] [MULTI3] When intelligent auto is activated, the maximum frame rate is limited to 7.5 fps in 15 fps mode and 6.25 fps in 12.5 fps mode regardless of the frame rate.

- [New X Fixed-8MP][New X Fixed-6MP][New X Fixed-5MP] If [Image capture mode] is set to [60fps Mode] or [50fps Mode], [Intelligent Auto] cannot be used.

Advanced settings

[Auto contrast adjust]

Use [On] or [Off] to set the auto-contrast adjust function.

[On]: Activate the automatic contrast adjustment function.

[Off]: Stops the automatic contrast adjustment function.



[Note:]

- If [Intelligent Auto] is set to [On], this item cannot be set.
- [New X Fixed-8MP][New X Fixed-6MP][New X Fixed-5MP] If [Image capture mode] is set to [60fps Mode] or [50fps Mode], [Auto contrast adjust] cannot be used.

[Contrast level]

Adjust the contrast intensity.

Move the slider bar in the [+] direction to increase the contrast of the image.

Move the slider bar in the [-] direction to reduce the image contrast.

Press [Reset] to return to the default settings.



[Note:]

- If [Fog compensation] is set to [On], this item cannot be set.

[Adaptive black stretch]

Adjust the brightness of the dark area of the image.

Move the slider bar in the [+] direction to brighten the dark area of the image.

Move the slider bar in the [-] direction to darken the dark area of the image.

Press [Reset] to return to the default settings.



[Important]

- The [Adaptive black stretch] setting may cause darker areas to become more noisy, and darker or brighter areas may be near the border between darker and brighter areas than other darker areas.



[Note:]

- If [Fog compensation] is set to [On], this item cannot be set.

[Adaptive highlight stretch]

Adjust the brightness of the bright area of the image.

Moving the slider bar in the [+] direction will increase the contrast between the light and dark areas of the image.

Move the slider bar in the [-] direction to reduce the contrast between the light and dark areas of the image.

Press [Reset] to return to the default settings.



[Note:]

- If [Fog compensation] is set to [On], this item cannot be set.

[Fog compensation]

On/Off sets whether the fog correction function is enabled.

If [Intelligent Auto] is set to [On] or [Auto contrast adjust] is set to [On], it cannot be set. With the fog correction function, digital image processing can be used to correct images easily when they are blurred, such as when a fog occurs.

On: Enables the fog correction function.

Off: Stops the fog correction function.



[Note:]

- When [Fog compensation] is set to [On], [Contrast level], [Adaptive black stretch], and [Adaptive highlight stretch] cannot be set.

[Level]

Adjust the fog correction level.

Moving the slider bar in the [+] direction increases the correction level, while moving the slider bar in the [-] direction decreases the correction level. Press [Reset] to return to the default settings.

Pedestal level

Move the slider bar to adjust the black level of the image.

Moving the slider bar in the [+] direction brightens the image. Move the slider bar in the [-]

direction to darken the image. Press [Reset] to return to the default settings.

Scene registration

[Scene file]

The combination of the set items can be saved as a scene file. Select the scene file here.

You can set the saved scene file on the schedule page. If the shooting environment changes greatly depending on the time, you can record the image with a combination of settings appropriate to the environment by registering it in the schedule.

→15 [\[Schedule\] for scheduling](#)

[Scene file title]

You can change the scene file name (up to 10 characters) to be displayed in [Scene file]. Only the file names displayed in [1:], [2:], [3:], [4:] can be changed.

Characters that cannot be entered:Half-pitch symbol " & ¥

[Load] buttons

The set data selected in [Scene file] is loaded and reflected in the current image.

[Register] buttons

This feature registers combinations of currently displayed image quality-adjusted settings in a scene file displayed on the [Scene file].

9.4.2 Set the mask area

This section explains how to adjust the light intensity by masking a portion of the screen.

To configure the mask area, set [Super Dynamic] to [Off].

- 1 Displays the image quality adjustment setting screen.

→9.4 [\[Image quality\] to set the image quality](#)

- 9 [Image/Audio] for setting images and sound files
 - 9.4 [Image quality] to set the image quality
-

| | |
|---------------------------------------------------------------------|---------------------------------------------------------------|
| Cam. 1 Scene file is not applied | |
| +Basic adjustment | |
| +Super Dynamic(SD) | <input type="radio"/> On <input checked="" type="radio"/> Off |
| +Light control mode | ELC ▼ |
| +Day & Night(IR) | Auto1(Normal) ▼ |
| +White balance | ATW1 Set |
| +Intelligent Auto | <input type="radio"/> On <input checked="" type="radio"/> Off |
| +Detailed setting | |
| +Scene registration | |
| *Any changes are updated immediately | |
| *Adjust the detail setting individually in the menu of each camera. | |
| Close | |

- 2 Click + to the left of the [Super Dynamic] to view the Detailed Super Dynamics menu.

| | |
|---------------------------|-----------------------------------------------------------------------------------------------------------------------------------------------------------------------------------------------------------------------------------------------------------------------------------------------------------------------------------------------------------------------------------------------------------------------------------------------------------------------------------------------------------------------------------------|
| -Super Dynamic(SD) | <input type="radio"/> On <input checked="" type="radio"/> Off |
| Level | <input type="button" value="-"/> <input type="button" value="+"/> 27 Reset |
| BLC/ HLC | Off ▼ |
| BLC level | <input type="button" value="-"/> <input type="button" value="+"/> 16 Reset |
| HLC level | <input type="button" value="-"/> <input type="button" value="+"/> 16 Reset |
| Mask area | <input type="button" value="Start"/> <input type="button" value="End"/> <input type="button" value="Reset"/> |

- 3 Clicking on the [Start] buttons in the [Mask area] displays the boundaries and divides the images displayed on the [Image quality] tabs into 48 (8×6).

9 [Image/Audio] for setting images and sound files
9.4 [Image quality] to set the image quality

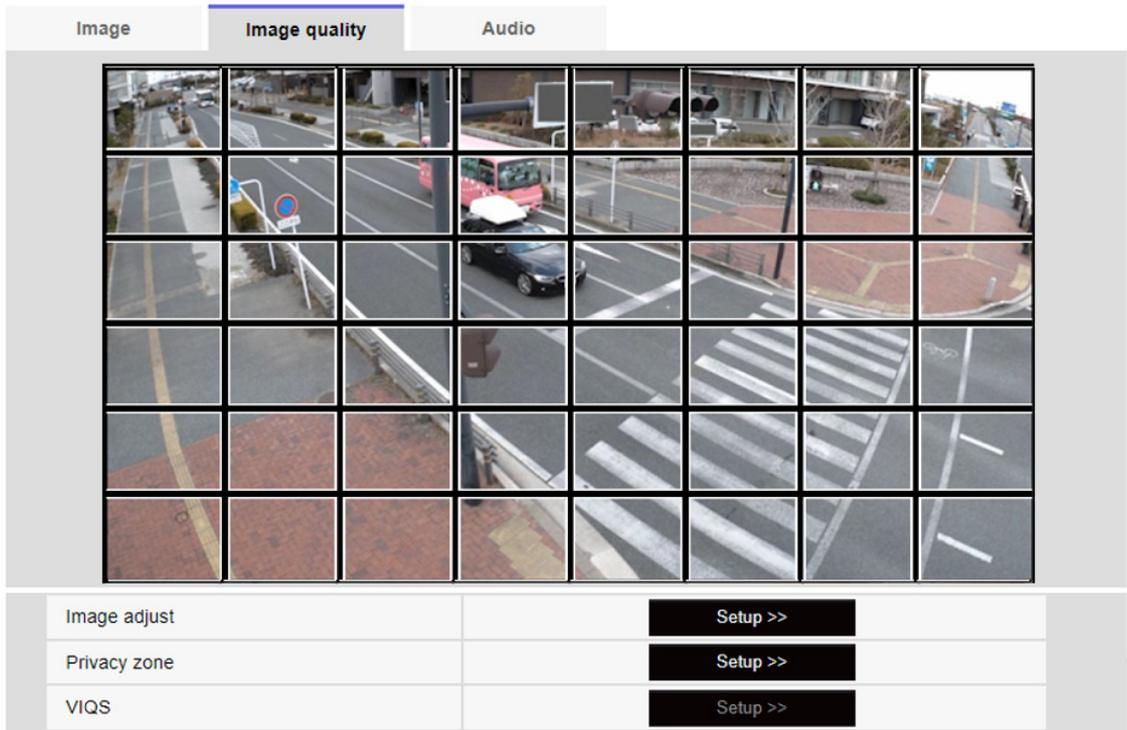

- 4 Click the split area to be masked to set the frame you clicked to the mask area and turn white. To release the mask, click the mask area again.

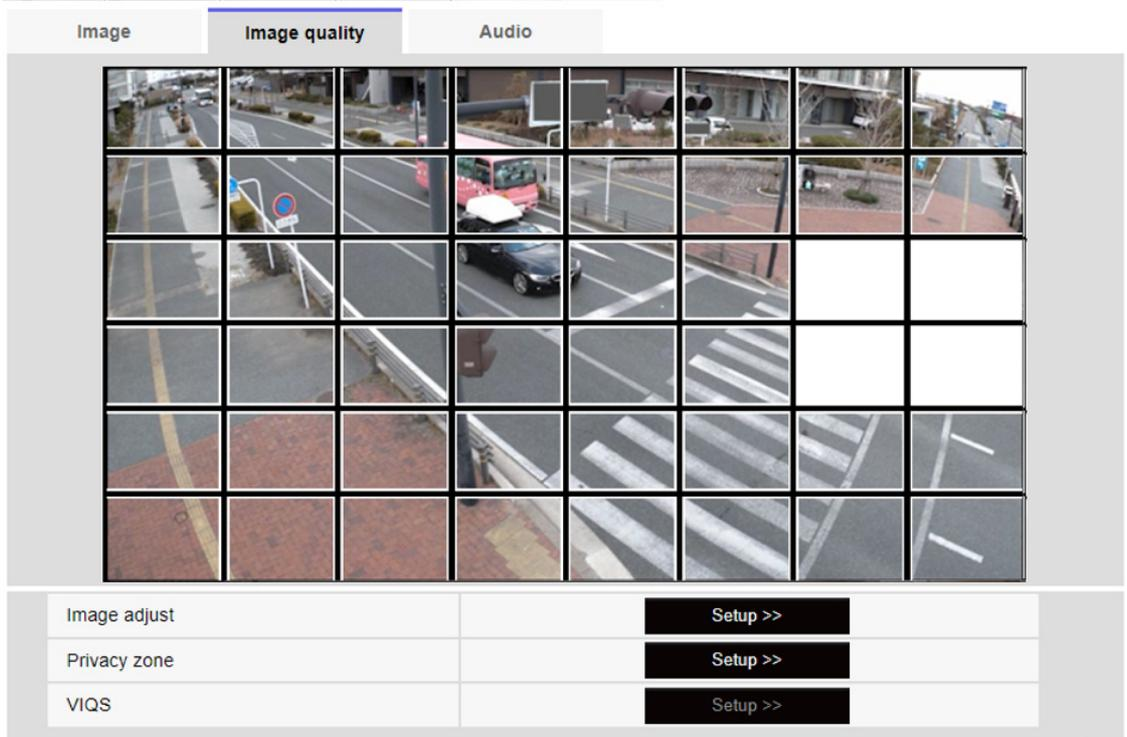

- 5 Once the mask area has been set, clicking [Stop] will clear the frame from the images on the [Image quality] tab.



[Important]

- If you change the [Image capture mode] of the [Image] tabs after you configure the mask area, the mask area may be misaligned. Be sure to check the mask area settings again.
- If you set EX optical zoom or HD EX optical zoom after setting the mask area, the mask area may be misaligned. Be sure to check the mask area settings again.



[Note:]

- To cancel all mask areas, press [Reset].

9.4.3 Adjust the angle of view with the EX zoom



[Note:]

- [MULTI] This function cannot be adjusted when [Image capture mode] is in Quad/Dual mode.

To Advanced Settings in [Extra zoom] on the [Image quality] tabs of video pages>>Click the [Button]. ([Image quality] for setting image quality adjustment, zoom/focus, privacy zone, VIQS, and lens distortion compensation)

→9.4 [\[Image quality\] to set the image quality](#)

Use EX Zoom to adjust the angle of view of the image.



[Note:]

- [MULTI] The camera to adjust the angle of view can be selected.

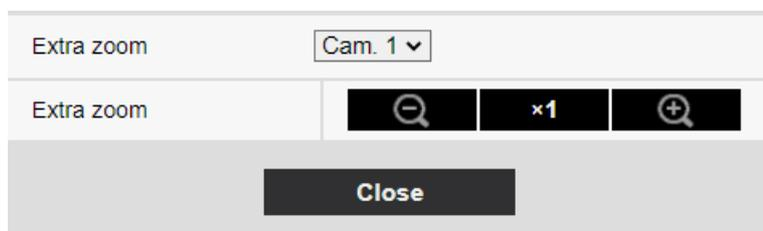

- Adjust the zoom factor in the [Wide angle] direction.
 - Zoom (magnification) 1.0 times.
- Adjust the zoom factor in the [Telescope] direction.



[Note:]

- The maximum magnification of the EX zoom depends on the model and the [Image capture mode] you are configuring.
- Refer to the catalog specifications for the maximum magnification of each model.



[Important]

- The extra zoom function may not be activated on the appropriate position if the setting for the function is performed after the settings for the VIQS area, privacy zone, VMD area, and SCD area. Therefore, configure each area's settings after configuring the extra zoom settings.

→9.4.7 Set up VIQS

→9.4.6 Setting the privacy zone (Privacy zone setting screen)

→12.5 [VMD area] for setting motion detection

→12.7 [SCD area] to set up undesired detection

- Set the mask area to 1.0 times the zoom factor. After the EX zoom is set, the mask position is specified when the zoom (magnification) is 1.0 times.

→9.4.2 Set the mask area

9.4.4 Adjust the angle of view with the Ex optical zoom

To Advanced Settings in [Extra optical zoom] on the [Image quality] tabs of video pages>>Click the [Button]. ([Image quality] for setting image quality adjustment, zoom/focus, privacy zone, VIQS, and lens distortion compensation)

→9.4 [Image quality] to set the image quality

Use Ex optical zoom to adjust the angle of view of the image.

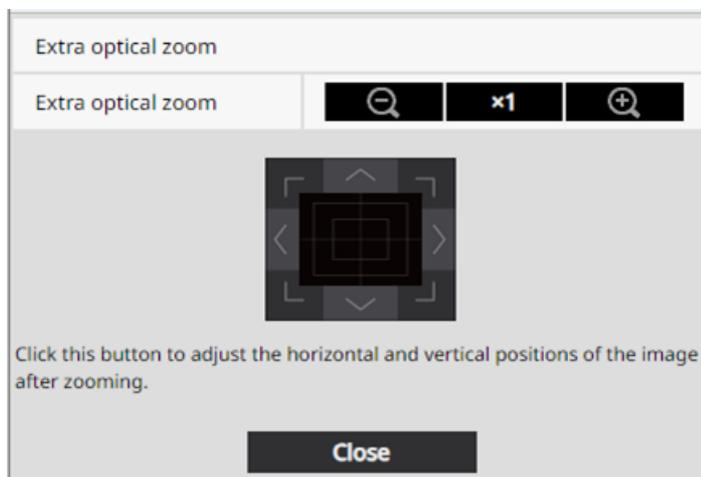

- Adjust the zoom factor in the [Wide angle] direction.
 - Zoom (magnification) 1.0 times.
- Adjust the zoom factor in the [Telescope] direction.



[Note:]

- The maximum magnification of the Ex optical zoom depends on the model and the [Image capture mode] you are configuring.
- Refer to the catalog specifications for the maximum magnification of each model.



[Important]

- The EX optical zoom function may not be activated on the appropriate position if the setting for the function is performed after the settings for the VIQS area, privacy zone, VMD area, and SCD area. Therefore, configure each area's settings after configuring the EX optical zoom settings.

→9.4.7 Set up VIQS

→9.4.6 Setting the privacy zone (Privacy zone setting screen)

→12.5 [VMD area] for setting motion detection

→12.7 [SCD area] to set up undesired detection

- Set the mask area to 1.0 times the zoom factor. After the EX optical zoom is set, the mask position is specified when the zoom (magnification) is 1.0 times.

→9.4.2 Set the mask area

9.4.5 Adjust the zoom/focus



[Note:]

- This function cannot be adjusted when [Image capture mode] is in dual-mode.

To [Advanced Settings] in [Zoom/Focus Adjustment] of the [Image quality] tabs on the video pages>>Click the [Button]. ([Image quality] for setting image quality adjustment, zoom/focus, privacy zone, VIQS, and lens distortion compensation)

→9.4 [Image quality] to set the image quality

Use Zoom and EX optical zoom to adjust the angle of view of the displayed image.

Adjust the focus by moving the lens focus to the optimal position. It can be adjusted manually or automatically.

- 9 [Image/Audio] for setting images and sound files
 - 9.4 [Image quality] to set the image quality
-



[Note:]

- [MULTI] The camera to adjust the angle of view can be selected.

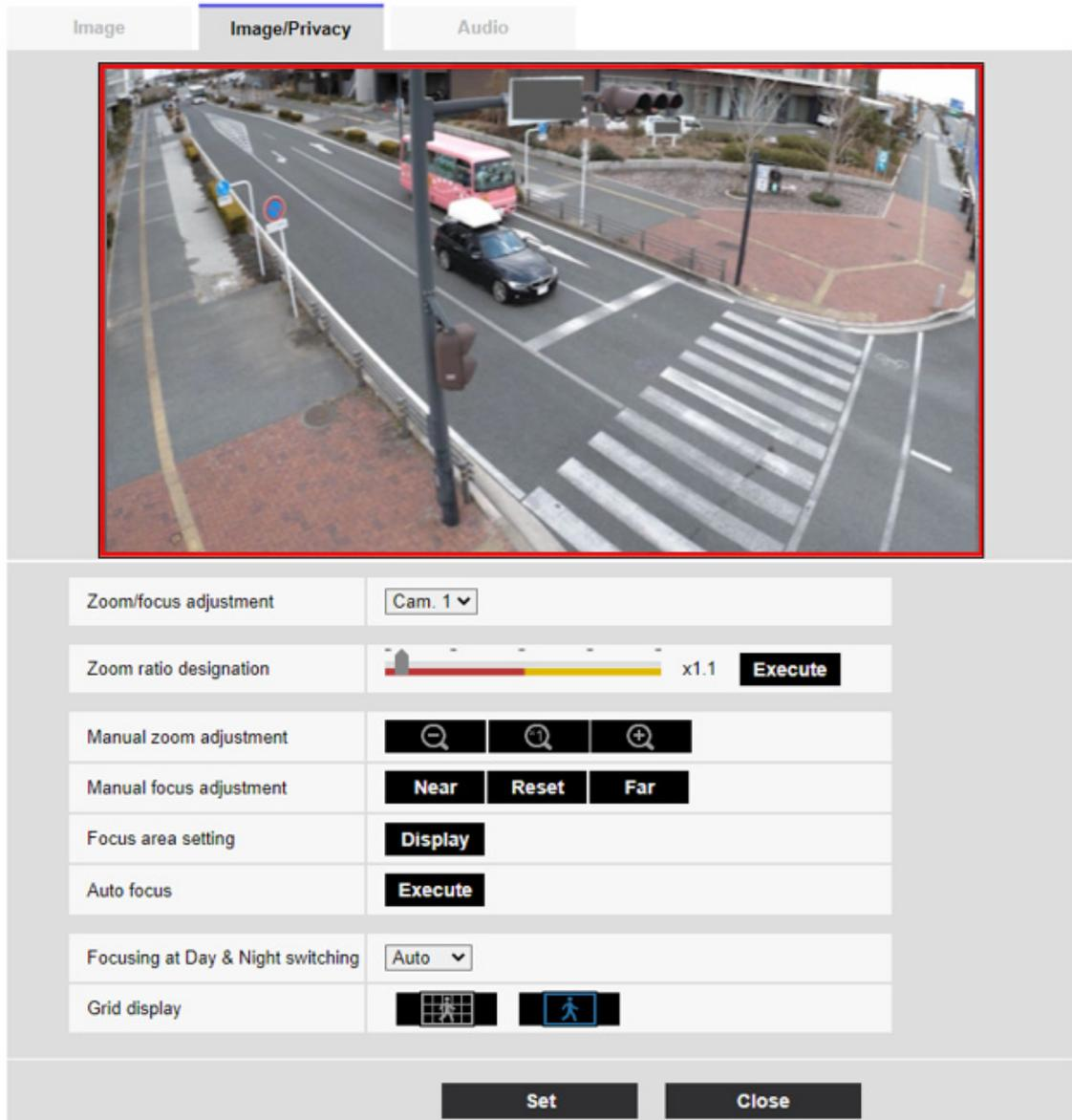

[Zoom ratio designation]

Adjust the zoom and focus simultaneously.

Press the slider bar to zoom in or out the angle adjustment frame in the image.

When you adjust the zoom (magnification) in the "telephoto" direction, only the image adjustment frame is reduced and you can specify the zoom (magnification) while checking the angle of view after the zoom is executed.

When the zoom (magnification) is adjusted in the "Wide angle" direction, the image itself is reduced or the frame for the zoom angle adjustment is enlarged. You can specify the zoom (magnification) while checking the image size after the zoom is executed.

Adjust the angle of view adjustment frame, and click [Execute] to zoom. Then, automatically adjust the focus to the object in the center of the window using the auto focus function.



[Note:]

- The maximum magnification of the EX zoom depends on the model and the [Image capture mode] you are configuring.
- Refer to the catalog specifications for the maximum magnification of each model.
- In the [Manual zoom adjustment]  Buttons,  When you press buttons, [Zoom ratio designation] cannot be operated. To perform [Zoom ratio designation], click the "Read" button or click the X1 button on the [Manual zoom adjustment].
- [New X Fixed] If [Stabilizer] is set to [On], the maximum zoom factor is limited.



[Important]

- When EX optical zoom is set with the VIQS area, privacy zone, operation detection area, undesired detection area, and mask area set, the position is misaligned. Therefore, set the EX optical zoom and then set each area.
 - 9.4.7 [Set up VIQS](#)
 - 9.4.6 [Setting the privacy zone \(Privacy zone setting screen\)](#)
 - 12.5 [\[VMD area\] for setting motion detection](#)
 - 12.7 [\[SCD area\] to set up undesired detection](#)
 - 9.4.2 [Set the mask area](#)

[Manual zoom adjustment]

Adjust the zoom manually.

 Adjust the zoom factor to 1.0 times in the [Wide Angle] direction.

 Zoom (magnification) is 1.0 times.

: Adjust the zoom factor in the [Telescope] direction.

[Manual focus adjustment]

Adjust the focus manually.

[Near]: Adjust the focus to the [Near].

[Reset] returns focus (focus) to its default settings.

[Far]: Adjust the focus to the [Far].



[Note:]

- One-click on the [Near] or [Far] buttons may appear to have no change in focus due to trace adjustments. If you want to move the focus position large, press and hold the button for a long time.
- [New X Fixed] If [Stabilizer] is set to [On], the maximum zoom factor is limited.

[Focus area setting]

When auto focus is executed, you can specify the object in the frame where you want to adjust the focus.

If not, adjust the focus to the object in the center area of the window.

[Display]: Displays the auto focus frame on the setup window. The default setting is displayed in the center area of the screen. Drag the mouse on the image and specify the area where you want to adjust the focus. When you are finished, press [Register].

When the [Display] button is clicked, the [Reset] and [Register] buttons are displayed.

[Reset]: Returns the frame setting to the default position.

[Register]: Saves the set frame. Clicking to automatically adjust focus to the object in the specified area

I do.



[Note:]

- If you set the focus frame and then change the [Rotate images][Stabilizer] on the [Basic] tab or [Image capture mode] on the [Image] tab, the focus frame may be misaligned. Be sure to check the focus frame settings again.

[Auto focus]

When [Execute] is clicked, the auto focus function is activated to automatically adjust the focus to the object in the center of the window.



[Important]

- If the [Image capture mode] is [Single source [4:3](30fps mode)], it may take a lot of time for auto focus to be completed if auto focus is executed while the slow shutter is running at night while [Maximum shutter] is set to longer than [1/30s].
- If the [Image capture mode] is [Single source [4:3](25fps mode)], it may take a lot of time for auto focus to be completed if auto focus is executed while the slow shutter is running at night while [Maximum shutter] is set to longer than [1/25s max.].
- The focus may not be adjusted automatically in the following locations or object.

In this case, adjust the focus manually.

Be a big move

Large variation in illumination

Low illuminance

Be too bright or too reflective

Over the window

Dome covers are prone to contamination.

White walls are less dark.

Flicker fiercely

- When the image is switched from color to black and white in the near infrared region, the focus may shift due to the optical characteristics. If [Focusing at Day & Night switching] is set to [Auto] or [Preset], the camera can focus automatically (it does not support the lighting change after the focus operation is completed).

[Focusing at Day & Night switching]

Select the focus adjustment method when switching between color image and black-and-white image from the following.

For details, refer to our technical information website <Control No. C0315>.

[Auto]:The focus is automatically adjusted when the color/black-and-white settings are changed from the focus-adjusted image. When the original color/black/white status is changed, the focus position is returned to the last one. If the image cannot be adjusted with a black-and-white image, the image may be re-adjusted with a color image and then switched to a black-and-white image.

[Preset]:When switching between color image and black-and-white image, the preset is moved to the specified focus position. In the preset position, the color image or black-and-white image automatically stores the focus position set last.

[Fix]:After adjusting the focus automatically or manually, fix the position.



[Important]

- If the focus cannot be adjusted automatically when switching between color and black and white images in the [Auto] setting, set it to [Preset] or [Fix] and adjust the focus manually.

[Grid display]

You can switch on/off the grid view that can be used to adjust the position of the machine when using Extension software. For adjusted sizes for each Extension software, please refer to our

Technical Information website<Control No.: C0320>.

[Close] buttons

Close the Zoom/Focus dialog box.

9.4.6 Setting the privacy zone (Privacy zone setting screen)

In the Video/Audio [Image quality] tabs to [Privacy zone] Advanced Settings>>Click the [Button].

→9.4 [Image quality] to set the image quality

If there are areas in the shooting location (image) that you do not want to display, do not display those areas as privacy zones.



[Note:]

- Refer to the catalog specifications for the number of privacy zones that can be set for each model.
- [PTZ] The Privacy Zone function does not work during initial operation or position refresh immediately after the power supply is turned on.
- [PTZ] Depending on the orientation of the camera (especially the tilt angle of 45° to 90°) or the magnification factor, you may see where you want to hide. Be sure to check after setting.
- [PTZ] Reset the Privacy Zone when you change the method of fixing the camera.

The privacy zone function of each camera is described below.

New X Fixed Cameras

- 9 [Image/Audio] for setting images and sound files
- 9.4 [Image quality] to set the image quality

Image
Image quality
Audio



Area can be set by designating 4 points on the screen.

Privacy zone Display type : Filling
Privacy zone Display type can be Set in Basic setting page. [Basic settings >>](#)

| | | | | |
|--------|--------------------------------------------------------------------|---------------------------------------------------------------|---------------------------------------------------------------|---------------------------------------------------------------|
| Area | 1(White) <input type="checkbox"/> | 2(Blue) <input checked="" type="checkbox"/> | 3(Green) <input checked="" type="checkbox"/> | 4(Red) <input checked="" type="checkbox"/> |
| Status | <input type="radio"/> On <input checked="" type="radio"/> Off | <input type="radio"/> On <input checked="" type="radio"/> Off | <input type="radio"/> On <input checked="" type="radio"/> Off | <input type="radio"/> On <input checked="" type="radio"/> Off |
| Delete | <input type="button" value="Delete"/> | <input type="button" value="Delete"/> | <input type="button" value="Delete"/> | <input type="button" value="Delete"/> |
| Area | 5(Yellow) <input checked="" type="checkbox"/> | 6(Light blue) <input checked="" type="checkbox"/> | 7(Purple) <input checked="" type="checkbox"/> | 8(Pink) <input checked="" type="checkbox"/> |
| Status | <input type="radio"/> On <input checked="" type="radio"/> Off | <input type="radio"/> On <input checked="" type="radio"/> Off | <input type="radio"/> On <input checked="" type="radio"/> Off | <input type="radio"/> On <input checked="" type="radio"/> Off |
| Delete | <input type="button" value="Delete"/> | <input type="button" value="Delete"/> | <input type="button" value="Delete"/> | <input type="button" value="Delete"/> |
| Color | <input type="text" value="Gray"/> <input type="button" value="v"/> | | | |

Compact Dome cameras, Corner cameras

- 9 [Image/Audio] for setting images and sound files
- 9.4 [Image quality] to set the image quality



[Area]

This is set as the privacy zone by specifying four vertices on the image. Each zone can also be set in overlap. The zones are set in order from Area 1.



[Note:]

- The privacy zone should be wider than the hidden object.

[Status]

Use [On]/[Off] to set whether the privacy zone is displayed.

[On]:Displays the privacy zone.

[Off]:Privacy zone is not displayed.

[Collar]

You can select the color of the Privacy Zone to be displayed in the video area from the following.

[Gray]/[Red]/[Blue]/[Green]/[White]/[Black]



[Note:]

- [Color] can be set when [Privacy zone display format] is set to [Block] in the basic settings window.

[Intensity of mosaic]

You can select how to mosaic the Privacy Zone to be displayed in the video area.

[High]/[Middle]/[Low]



[Note:]

- [Intensity of mosaic] can be set when [Privacy zone display format] is set to [Blurring] in the basic settings window.

[Delete] buttons

Click the button on the area to delete the button to delete the zone.

[Close] buttons

Close the Privacy Zone Settings window.



[Important]

- If you configure a privacy zone and then change the [Image capture mode] and [Basic] tab [Image rotation] on the [Image] tab, the privacy zone may be misaligned. Be sure to check the privacy zone settings again.
- Setting the privacy zone and then setting the EX zoom may cause the privacy zone to be misaligned. Be sure to check the privacy zone settings again.
- If the privacy zone is set when lens distortion compensation is enabled, it may be misaligned. In such a case, return the lens distortion compensation to [0] and set the privacy zone. Then, set the lens distortion compensation again.
- [New X Fixed] If you configure the Privacy Zone area with a Image capture size of 1920x1080 or less, the Privacy Zone may be offset. Be sure to check the privacy zone settings again.

PTZ cameras

9 [Image/Audio] for setting images and sound files

9.4 [Image quality] to set the image quality

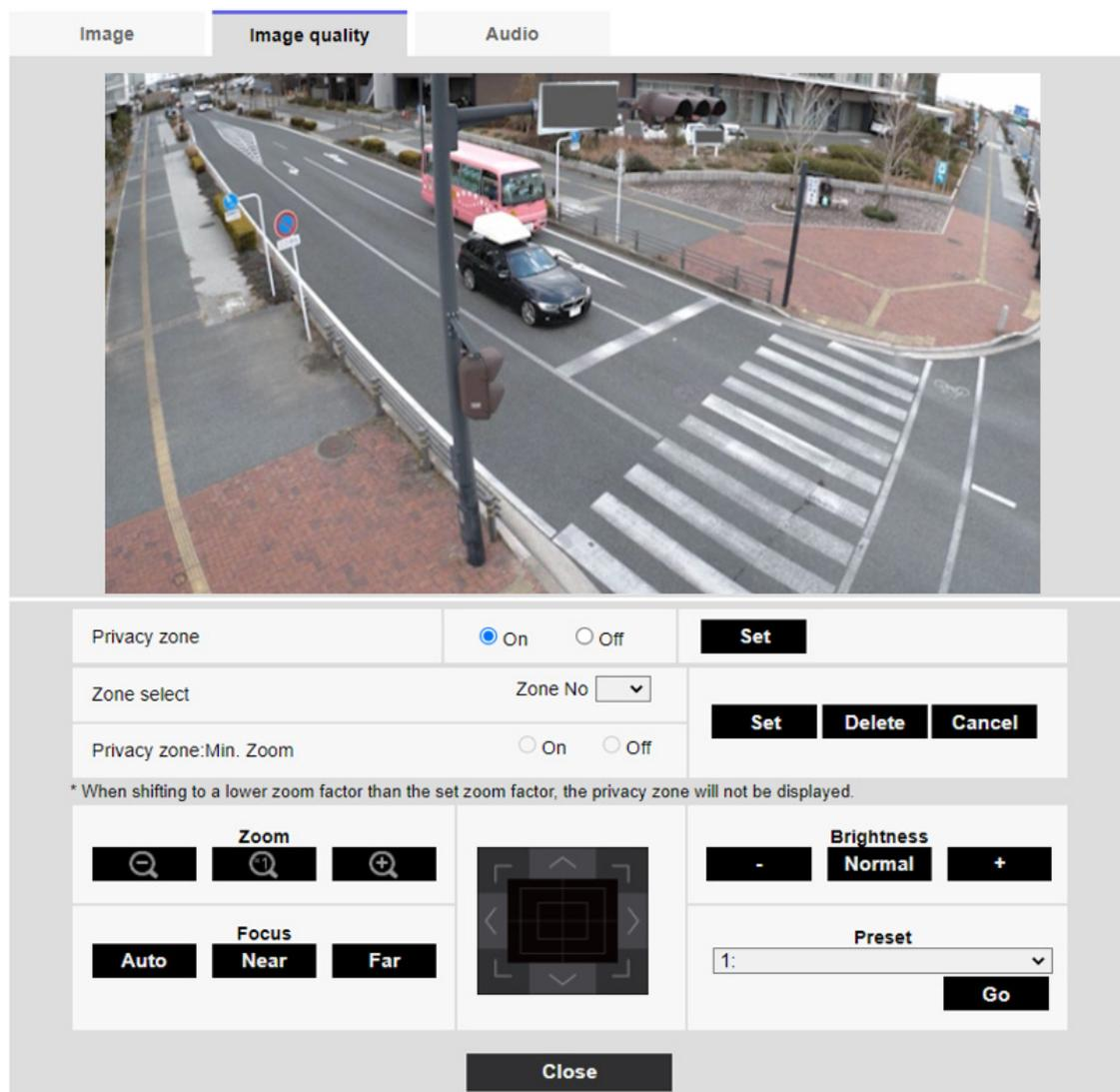

[Privacy zone]

Select the display format of the privacy zone from the following.

[On]: Display in gray

[Off]: Not displayed.

[Zone select]

Click [▼] on the [Zone No] and select the number of zones you want to set.

The [*] mark to the right of the zone number indicates that a privacy zone has already been set.

When you drag the desired range with the mouse, it is set as the privacy zone.

Once the position has been determined, press [Set].

To delete a registered zone, specify the zone number and press [Delete].

To cancel setting or deletion, press [Cancel].



[Note:]

- The privacy zone should be set broadly for objects that you want to hide. It is recommended to set the zone between 1 and 3 times the zoom magnification to increase the zone accuracy on the wide angle side.

[Privacy zone:Min. Zoom]

Use [On] or [Off] to toggle the smallest zoom in zones.

[On]:The current zoom position is saved.

[Disable]:The zoom position is saved as X1 times. The privacy zone is always displayed regardless of the zoom position.



[Note:]

- If enabled, the privacy zone will not be displayed if you move to a magnification lower than the set zoom magnification.

[Zoom] buttons

:Adjust the zoom factor in the [Telescope] direction.

:Zoom (magnification) 1.0 times.

:Adjust the zoom factor in the [Wide angle] direction.

[Focus] buttons

[Auto]:Automatically adjust focus.

[Near]:Adjust the focus (focus) to [Near].

[Far]:Adjust the focus (focus) to [Far].

Control pad/button

Left-click the pads and buttons to adjust the horizontal and vertical position of the image (pan tilt).

The faster the camera operates, the faster the outside of the pad is clicked.

You can also drag and adjust the mouse. Zoom and focus by right-clicking.

Clicking on the upper half of the pad in the upper and lower directions will zoom in the telephoto, and clicking on the lower half will zoom in the wide angle. Clicking on the left half in the left and right directions will bring the focus (focus) close to you, and clicking on the right half will bring it far away. You can also adjust the zoom by using the mouse wheel.

[Brightness] buttons

It can be adjusted from 0 to 255. Click the [Light (+)] button to brighten the image. Click the [Black (-)] button to darken the image. Press [Normal] to return to the default settings.

Move button

- 9 [Image/Audio] for setting images and sound files
- 9.4 [Image quality] to set the image quality

Select the preset position from the pull-down menu and click the [Move] button to move the camera's orientation to the preset position registered beforehand. [H] next to the number indicates the home position. Select [HomePosition] to move the orientation of the camera to the home position.

→10.2.1 Set the preset position (preset position setting screen)

→10.1 [Cam. Function] for setting the operation of cameras

If [Preset ID (0 - 9,A - Z)] is registered, the position name is displayed next to the number.

[Close] buttons

Click this button to close the Privacy Zone Settings window.

Multi-directional camera

Image
Image quality



Area can be set by designating 4 points on the screen.

Privacy zone Cam. 1 ▾

| | | | | |
|--------|-------------------------------------------------------------------------------------------------------------------------|----------------------------------------------------------------------------------------------------------------------|-------------------------------------------------------------------------------------------------------------------------|-------------------------------------------------------------------------------------------------------------------|
| Area | 1(White) | 2(Blue) | 3(Green) | 4(Red) |
| Status | <input type="radio"/> On <input checked="" type="radio"/> Off | <input type="radio"/> On <input checked="" type="radio"/> Off | <input type="radio"/> On <input checked="" type="radio"/> Off | <input type="radio"/> On <input checked="" type="radio"/> Off |
| Delete | Delete | Delete | Delete | Delete |

| | | | | |
|--------|----------------------------------------------------------------------------------------------------------------------------|----------------------------------------------------------------------------------------------------------------------------|----------------------------------------------------------------------------------------------------------------------------|----------------------------------------------------------------------------------------------------------------------------|
| Area | 5(Yellow) | 6(Light blue) | 7(Purple) | 8(Pink) |
| Status | <input type="radio"/> On <input checked="" type="radio"/> Off | <input type="radio"/> On <input checked="" type="radio"/> Off | <input type="radio"/> On <input checked="" type="radio"/> Off | <input type="radio"/> On <input checked="" type="radio"/> Off |
| Delete | Delete | Delete | Delete | Delete |

Set
Close

[Camera selection]

Select the camera to set the privacy zone from each camera.



[Note:]

- When [Image capture mode] is in Quad/Dual mode, the camera cannot be selected.

[Area]

This is set as the privacy zone by specifying four vertices on the image. Each zone can also be set in overlap. The zones are set in order from Area 1.



[Note:]

- The privacy zone should be wider than the hidden object.
- When [Image capture mode] is in Quad/Dual mode, any four points across the cameras cannot be specified for the area.

[Status]

Use [On]/[Off] to set whether the privacy zone is displayed.

[On]:Displays the privacy zone.

[Off]:Privacy zone is not displayed.

[Delete] buttons

Click the button on the area to delete the button to delete the zone.

[Close] buttons

Close the Privacy Zone Settings window.



[Important]

- If you configure a privacy zone and then change the [Image capture mode] and [Basic] tab [Image rotation] [Stabilizer] on the [Image] tab, the privacy zone may be misaligned. Be sure to check the privacy zone settings again.
- Setting the privacy zone and then setting the EX zoom may cause the privacy zone to be misaligned. Be sure to check the privacy zone settings again.
- If the privacy zone is set when lens distortion compensation is enabled, it may be misaligned. In such a case, return the lens distortion compensation to [0] and set the privacy zone. Then, set the lens distortion compensation again.

9.4.7 Set up VIQS

To Advanced Settings on the [Image quality] tabs of Video/Audio pages [VIQS]>>Click the [Button].

→9.4 [Image quality] to set the image quality

What is VIQS?

Abbreviation for Variable Image Quality on Specified Area. This function enables you to change the image quality in the specified area.

Image quality in the range specified in the shooting location (image) can be made high quality for easy viewing. Image quality outside the specified range is low and image data size can be suppressed.



[Note:]

- VIQS covers only H.265 (or H.264) images.
- Up to eight VIQS areas can be set.
- After [Stream] is set to [On], press [Execute] to view the images after VIQS is set.
You can also view the H.265 (or H.264) image on a live image page.
- The VIQS function cannot be used in the following cases.
 - When [Stream(1)] [Smart VIQS] is set to [On(High)] or [On(Low)]
 - When-[Smart P-picture control] is set to [On]

The VIQS function of each camera is described below.

Fixed cameras

- 9 [Image/Audio] for setting images and sound files
- 9.4 [Image quality] to set the image quality



[Area]

When the VIQS area is selected in the image, it is set from Area 1.

[Status]

Set the VIQS area with [On] and [Off].

[On]:Set the VIQS area.

[Off]:Do not configure the VIQS area.

[Delete] buttons

Click the area button to delete the area frame.

[Level]

Sets the level difference between the quality in the specified range and the quality outside the specified range. The larger the level difference, the lower the image quality outside the specified range and the smaller the image data size.

[0:Minimum]/1/2/3/4/[5:standard]/6/7/8/[9:maximum]

Stream selection

Use [On]/[Off] to specify whether the VIQS function is enabled for images delivered to streams.

The [Execute] buttons allow you to view images of individual streams.



[Important]

- If you set the VIQS setting to [On] and then change the [Image capture mode] and [Basic] tab [Image rotation][Stabilizer] on the [Image] tab of the video and audio pages, the VIQS area may be misaligned. Be sure to reconfirm the VIQS settings.



[Note:]

- Refer to the following procedure for setting the VIQS area.
→ [9.4.8 Set up the VIQS area](#)
- If the [Stream transmission] of the relevant stream is set to [Off], you cannot press the [Execute] buttons for selecting the stream.

PTZ camera

Select the position for which you want to set the VIQS area and press [Start] to open the VIQS area setting window for the selected position.

You can specify the VIQS area on the displayed setting screen.

VIQS area setting

- 9 [Image/Audio] for setting images and sound files
 - 9.4 [Image quality] to set the image quality
-

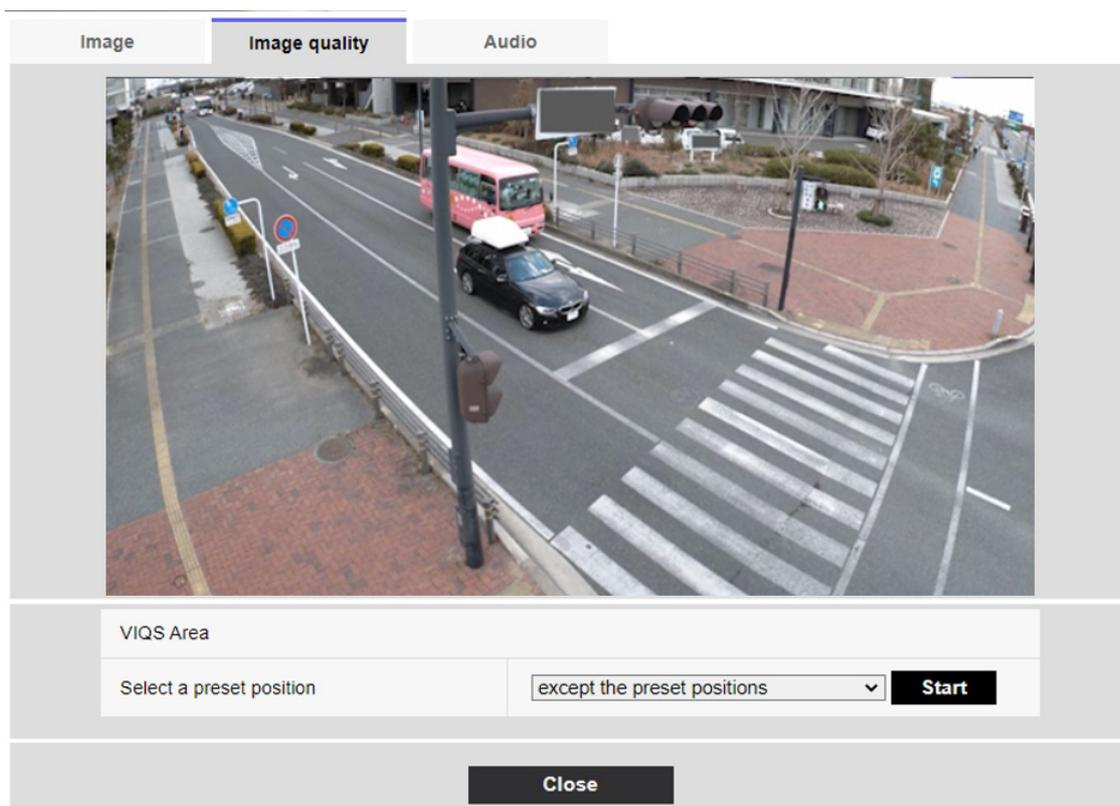

[Select a preset position]

Select the preset position number for which you want to configure the VIQS area, and then press [Start] to configure the VIQS area.

Select [except the preset positions] to set the VIQS area other than the preset position.

[Close] buttons

Click to close the VIQS Settings window.

- 9 [Image/Audio] for setting images and sound files
- 9.4 [Image quality] to set the image quality



[Area]

When the VIQS area is selected in the image, it is set from Area 1.

[Center] button

When clicked, the center is selected as the VIQS area and set to the [1(White)] of the [Area].

[Status]

Set the VIQS area with [On] and [Off].

[On]:Set the VIQS area.

[Off]:Do not configure the VIQS area.

[Delete] buttons

Click the area button to delete the area frame.

[Level]

Sets the level difference between the quality in the specified range and the quality outside the specified range. The larger the level difference, the lower the image quality outside the specified range and the smaller the image data size.

[0:Minimum]/1/2/3/4/[5:standard]/6/7/8/[9:maximum]

Stream selection

Use [On]/[Off] to specify whether the VIQS function is enabled for images delivered to streams.

The [Execute] buttons allow you to view images of individual streams.



[Important]

- If you set the VIQS setting to [On] and then change the [Image capture mode] and [Basic] tab [Image rotation] on the [Image] tab of the video and audio pages, the VIQS area may be misaligned. Be sure to reconfirm the VIQS settings.



[Note:]

- Refer to the following procedure for setting the VIQS area.
→ [9.4.8 Set up the VIQS area](#)
- If the [Stream transmission] of the relevant stream is set to [Off], you cannot press the [Execute] buttons for selecting the stream.

Multi-directional camera

- 9 [Image/Audio] for setting images and sound files
- 9.4 [Image quality] to set the image quality

Image
Image quality



Cam. 1
▼

| | | | | |
|--------|------------------------------------------------------------------------------------------------------------------------------------|---------------------------------------------------------------------------------------------------------------|-------------------------------------------------------------------------------------------------------------|---------------------------------------------------------------------------------------------------------|
| Area | 1(White) | 2(Blue) | 3(Green) | 4(Red) |
| Status | <input type="radio"/> On <input checked="" type="radio"/> Off | <input type="radio"/> On <input checked="" type="radio"/> Off | <input type="radio"/> On <input checked="" type="radio"/> Off | <input type="radio"/> On <input checked="" type="radio"/> Off |
| Delete | <input type="button" value="Delete"/> | <input type="button" value="Delete"/> | <input type="button" value="Delete"/> | <input type="button" value="Delete"/> |
| Area | 5(Yellow) | 6(Light blue) | 7(Purple) | 8(Pink) |
| Status | <input type="radio"/> On <input checked="" type="radio"/> Off | <input type="radio"/> On <input checked="" type="radio"/> Off | <input type="radio"/> On <input checked="" type="radio"/> Off | <input type="radio"/> On <input checked="" type="radio"/> Off |
| Delete | <input type="button" value="Delete"/> | <input type="button" value="Delete"/> | <input type="button" value="Delete"/> | <input type="button" value="Delete"/> |

Level 5 Normal ▼

Stream

| | | | |
|-----------|---------------------------------------------------------------|--|----------------------------------------|
| Stream(1) | <input type="radio"/> On <input checked="" type="radio"/> Off | | <input type="button" value="Confirm"/> |
| Stream(2) | <input type="radio"/> On <input checked="" type="radio"/> Off | | <input type="button" value="Confirm"/> |

Variable Image Quality on Specified area (VIQS) allows the designated area to retain higher image quality. The excluded area will have a decreased image quality, allowing for a lower image file size/bit rate to be used. To check the area to where VIQS is applied, push the confirm button after setting areas.

[Camera selection]

Select the camera to set the VIQS area from each camera.



[Note:]

- When [Image capture mode] is in Quad/Dual mode, the camera cannot be selected.

[Area]

When the VIQS area is selected in the image, it is set from Area 1.

[Status]

Set the VIQS area with [On] and [Off].

[On]:Set the VIQS area.

[Off]:Do not configure the VIQS area.

[Delete]

Click the button of the area to delete to delete the area frame.

[Level]

Sets the level difference between the quality in the specified range and the quality outside the specified range. The larger the level difference, the lower the image quality outside the specified range and the smaller the image data size.

[0:Minimum]/1/2/3/4/[5:standard]/6/7/8/[9:maximum]

Stream selection

Use [On]/[Off] to specify whether the VIQS function is enabled for images delivered to streams.

The [Execute] buttons allow you to view images of individual streams.



[Important]

- If you turn on the VIQS setting and then change the [Image capture mode] and [Basic] tab [Image rotation] on the [Image] tab of the video and audio pages, the VIQS area may be misaligned. Be sure to check the VIQS settings again.



[Note:]

- Refer to the following procedure for setting the VIQS area.

→9.4.8 [Set up the VIQS area](#)

- If the [Stream transmission] of the relevant stream is set to [Off], you cannot press the [Execute] buttons for selecting the stream.

9.4.8 Set up the VIQS area

Set the VIQS area as follows.

- 1 Drag the mouse on the image and specify the area. You can specify up to 8 areas.

- 9 [Image/Audio] for setting images and sound files
- 9.4 [Image quality] to set the image quality

The specified location is set to Area [1(White)], and a frame is displayed. Areas are set from the first to the first area number. The color next to the area number indicates the corresponding color of the frame.



- 2 Sets the level difference between the quality in the specified range and the quality outside the

specified range. The larger the level difference, the lower the image quality outside the specified range and the smaller the image data size.

- 3 On/Off selects whether to enable the VIQS function on the delivered image of each stream.
- 4 Press [Set].

The settings are reflected on the computer. To delete the setting area, click [Delete] in the area to delete.

- 5 Press [Execute].

The streams with the [Execute] buttons are displayed. The current output bit rate can be checked when another window opens for approximately 3 seconds.



[Important]

- If you do not press the [Set] buttons, the settings will not be confirmed.
- Visual image after VIQS setting can be confirmed by displaying the H.265 (or H.264) image on the live image page or by pressing [Execute] on the [Stream].
- The current output bit rate varies depending on the subject. Check the actual subject during operation.
- The larger the specified range, the larger the output bit rate. Check the current output bit rate and determine the size of the area.

9.4.9 Set the lens distortion compensation

To Advanced Settings on the [Image quality] tabs of Video/Audio pages [Lens distortion compensation]>>Click the [Button].

→9.4 [Image quality] to set the image quality

You can use lens distortion correction to correct the distortion.

The correction amount can be adjusted.

The degree of distortion compensation depends on the zoom factor. Adjust the image angle with the zoom setting and then set the lens distortion compensation.

[Camera selection]

Select the camera to adjust the lens distortion compensation from each camera.



[Note:]

- [MULTI] Only Multi-directional cameras can be selected for [Camera selection].
- [MULTI] When [Image capture mode] is in Quad/Dual mode, the camera cannot be selected.

[Lens distortion compensation]

You can switch the lens distortion compensation ON/OFF.

Move the slider bar in the [+] direction or [-] direction to adjust the image distortion.

Press [Reset] to return to the default settings.



[Note:]

- When EX optical zoom is used, lens distortion compensation does not work.
- When lens distortion compensation is set to ON, all cameras are set to ON.
Turning on lens distortion compensation may lower the frame rate.
- [New X Fixed]If [Shake] is set to [On], [Lens distortion compensation] cannot be used.
- [New X Fixed]If you set [Privacy Zone Display Format] to [Blurring], you cannot use [Lens distortion compensation].

9.5 [Audio] for setting sound

Click on the [Audio] tabs of the video and audio pages. Refer to the following how to display and operate the Advanced menu.

→5.1 [How to display](#)

→5.2 [How to operate](#)

Here, the settings related to sound are made.



[Note:]

- Images and sound are not synchronized. Therefore, there may be a slight deviation between the image and sound.
- Depending on the network environment, audio may be interrupted.

Voice input

[Mic select]

Select the microphone to use when receiving audio data.

[Internal]:Use the camera's built-in microphone.

[External]:Use the audio input from the microphone/line input jack.

[Mic input volume]

Set the volume of sound input to the computer. This setting is reflected in the volume of sound (listening) on the computer and the volume at [Audio recording].

[Mic strength]/[Mic in progress]/[Microphone weak]:Set the volume when the sound is entered into the camera by microphone.

[Line Strength]/[In Line]/[Line Weak]:Set the volume when the sound is inputted to the camera line.



[Note:]

- When [Mic select] is set to [Internal], the Line High, Line Medium, and Line Low cannot be selected.

[AGC (audio)]

The earpiece sound is automatically amplified and adjusted to the appropriate volume. Select the degree of amplification from High/Middle/Low. When set to [High], it is easier to hear a small sound, but it may be heard as a noise. If you are concerned about noise, set it to [Middle] or [Low]. This setting is linked to the [Audio recording] volume.

[Max bit rate]

Set the bit rate of sound compression.

[G.726]:16kbps/ 32kbps

[G.711] : 64 kbps (cannot be changed)

[AAC-LC]:64kbps/ 96kbps/ 128kbps

Voice delivery

[Audio transmission mode]

Set the communication mode for sending/receiving voice data between the computer and PC from the following.

[Off]:Audio data is not transmitted or received between the computer and the PC.

[Mic input]:The PC receives audio data from the computer. You can hear sound together with images on a PC. Images and sound are not synchronized.

[Audio output]:The audio data from the PC is transmitted to the computer. Audio can be played through a speaker connected to the computer.

[Interactive(Half-duplex)]:You can make both listening and outgoing calls. However, audio cannot be sent/received simultaneously.

[Interactive(Full-duplex)]:You can both listen and talk at the same time.



[Note:]

- The howling may occur depending on the operating conditions. In this case, do not allow the sound output from the PC to enter the microphone of the PC.
- [Audio recording] cannot be used when [Audio transmission mode] is set to [Interactive(Half-duplex)].
- When using live picture pages, use HTTPS to access live picture pages.

[Mic input interval (Camera to PC)]

Select the voice reception interval from the following.

[20ms]/ [40ms]/ [80ms]/ [160ms]



[Note:]

- The shorter the call interval, the shorter the delay time. Increasing the value lengthens the delay time but reduces speech interruption. Change the settings depending on your network environment.
- If [AAC-LC] is selected in [Audio input encoding format], [Mic input interval (Camera to PC)] cannot be selected.

[Audio output volume (PC to Camera)]

Sets the volume to which the sound from the PC is played from the computer.

[High]/[Middle]/[Low]

[Audio output interval (PC to Camera)]

Select the voice transmission interval from the following.

[160ms]/ [320ms]/ [640ms]/ [1280ms]



[Note:]

- The smaller the call interval, the shorter the delay time. Increasing the value lengthens the delay time but reduces speech interruption. Change the settings depending on your network environment, the performance of your PC, and the usage status of applications other than web browsers.
- When multiple users are accessing the computer, the sound may be temporarily interrupted or the noise may be output. Increasing the transmission interval can reduce speech interruptions and noise.
- Sound may not be output depending on your network environment and settings.

[Audio output duration]

You set the maximum time for one call.

[1min]/ [2min]/ [3min]/ [5min]/ [10min]/ [20min]/ [30min]/ [1h]



[Note:]

- The call stops after the set time after the start of the call. If you want to make another call, click the call button.

[Audio output port (PC to Camera)]

Enter the destination port number (the port number on the camera to send voice to the computer).

Configurable port number: 1024 to 50000 (even number only)



[Note:]

- The Destination port number entered in [Audio output port (PC to Camera)] is used only if [Transmission type] is set to [Unicast port (MANUAL)]. If [Stream transmission] has selected [Off] or [Transmission type] [Unicast port (AUTO)] or [Multicast], you do not need to enter the Destination port number.

Live image pages

[Audio input encoding format]

Select the compression method of earpiece voice from G.726/G.711/AAC-LC.



[Note:]

- Only AAC-LC can be accessed from a Web browser.
- G.711 can be selected only when [Audio transmission mode] is [Mic input].
- G.726 is always applied to the compression method for voice transmission.

[Audio volume control mode]

Select how to use the volume cursor of the earpiece button on the live picture page.

Adjust the PC volume: You change the volume of the PC that is opening the Live Picture page.

Manipulate camera audio input volume: You change the earpiece volume of the camera.

10 Set PTZ

The PTZ page is used to set the camera operation, preset position, and auto tracking.

The PTZ pages consist of the [Cam. Function], [Position], [Auto track setting], and [Auto track alarm setting] tabs.



[Note:]

- The items that can be set differ depending on the function of the model.
- Refer to the catalog specifications for the functions installed in each model.

10.1 [Cam. Function] for setting the operation of cameras

Click on the [Cam. Function] tab of the PTZ page. Refer to the following how to display and operate the Advanced menu.

→[5.1 How to display](#)

→[5.2 How to operate](#)

This section sets the operation of the camera.

10.1.1 [Cam. Function] for setting the operation of Rapid PTZ Cameras, Multi-directional + PTZ (PTZ part)

| Cam. Function | Position | Auto track | Auto track alarm setting |
|-------------------------------|---------------------------------------------------------------|------------|--------------------------|
| Basic settings | | | |
| Home position | Off ▾ | | |
| Self return | Off ▾ | | |
| Self return time | 1min ▾ | | |
| Upside-down | <input type="radio"/> On <input checked="" type="radio"/> Off | | |
| Maximum optical zoom ratio | Unlimited ▾ | | |
| HD Extra optical zoom | <input checked="" type="radio"/> On <input type="radio"/> Off | | |
| Digital zoom | <input type="radio"/> On <input checked="" type="radio"/> Off | | |
| Camera position display | Pan-Tilt degree/Zoom ratio display ▾ | | |
| Operation mode display | <input type="radio"/> On <input checked="" type="radio"/> Off | | |
| Tilt-flip | <input checked="" type="radio"/> On <input type="radio"/> Off | | |
| Tilt Angle | -20° ▾ | | |
| Set | | | |
| Advanced setting | | | |
| Maximum optical zoom speed | High ▾ | | |
| Maximum panning/tilting speed | Unlimited ▾ | | |
| Pan/Tilt Operability | Profile1(Normal) ▾ | | |
| Focus distance | Unlimited ▾ | | |
| Auto position refresh | <input type="radio"/> On <input checked="" type="radio"/> Off | | |
| Set | | | |

[Home position]

You can set the preset position as the home position.

When the home position is set, [H] is displayed next to the preset position number.

→[10.2.1 Set the preset position \(preset position setting screen\)](#)



[Note:]

If you want to move to the home position when the power is turned on, set [HomePosition] to [Self return].

[Self return]

When the time set by [Self return time] has elapsed after manual operation, the camera can automatically return to one of the following modes of operation.

[Off]: Do not perform self-return.

[Home position]: After the set time has elapsed, the watch returns to the home position.

[Auto Pan]: When the set time elapses, the auto pan operation starts.

[Preset Sequence 1]: When the set time elapses, Sequence 1 operation starts.

[Preset Sequence 2]: Sequence 2 operation starts when the set time elapses.

[Preset Sequence 3]: Sequence 3 operation starts when the set time elapses.

[Patrol]: When the set time elapses, the patrol operation starts.



[Note:]

If you want to perform the above operations when turning on the power, it is convenient to use the self-turn function.

The Self-turn function works even when the Setup menu is displayed.

- [Patrol] can be set only when patrols are set.

- [10.2.4 Set patrol \(Patrol function setting screen\)](#)

- [Preset sequence] can be set only when the preset sequence is set.

- [10.2.2 Set the preset sequence setting \(preset sequence setting screen\)](#)

[Self return time]

After the manual operation is completed, select the time from the following to return to the operation set by [Self return].

[10s]/ [20s]/ [30s]/ [1min]/ [2min]/ [3min]/ [5min]/ [10min]/ [20min]/ [30min]/ [60min]

[Maximum optical zoom ratio]

Select the maximum zoom ratio for the optical zoom from the following. Refer to the catalog specifications for the installed optical zoom ratio.

- Optical zoom: 21x model x1/x2/x3/x4/x5/x6/x7/x8/x9/x10/x11/x12/x13/x14/x15/x16/x17/x19/x20/unlimited

- Optical zoom: 30x model x1/x2/x3/x4/x5/x6/x7/x8/x9/x10/x11/x12/x13/x14/x15/x16/x17/x18/x19/x20/x21/x22/x24/x26/x27/x28/x29/unlimited

- Optical zoom: 32x model x1/x2/x3/x4/x5/x6/x7/x8/x9/x10/x11/x12/x13/x14/x15/x16/x17/

x18/x19/x20/x21/x22/x23/x24/x26/x27/x28/x30/x31/unlimited

- Optical zoom: 40x model x1/x2/x3/x4/x5/x6/x8/x8/x9/x10/x11/x12/x13/x14/x15/x16/x17/x18/x19/x20/x21/x22/x23/x24/x26/x27/x28/x29/x30/x31/x32/x33/x34/x36/x37/x38/x39/unlimited

[HD Extra optical zoom]

Select the setting of HD EX optical zoom from the following.

[On]:When the optical zoom range is exceeded, the HD EX optical zoom is performed.

[Off]:HD EX optical zoom is not performed. It is within the optical zoom range.

What is HD EX optical zoom?

Among the effective pixels of the MOS sensor, approximately 920,000 pixels (equivalent to 1280 x 720 resolution) are cut off from the center and shot. Therefore, using a resolution of less than 1280 x 720 makes it possible to shoot with a higher telephoto effect.

About HD EX optical zoom

- Optical zoom: For a 21x model, x1 to x21 optics is performed, and for more than x31 HD EX optical zoom is performed.
- Optical zoom: For a 30x model, x1 to x30 optics is performed, and for more than x90 HD EX optical zoom is performed.
- Optical zoom: For a 32x model, x1 to x32 optics is performed, and for more than x48 HD EX optical zoom is performed.
- Optical zoom: For a 40x model, x1 to x40 optics is performed, and for more than x60 HD EX optical zoom is performed.

[Digital zoom]

Select the digital zoom setting from the following.

[On]:When the optical zoom and HD EX optical zoom are exceeded, digital zoom is performed.

[Off]:Digital zoom is not performed.

About Digital zoom

- Optical zoom: For a 21x model, x1 to x21 optical zoom, x31 HD EX optical zoom, and more (up to x336) digital zoom are performed.
- Optical zoom: For a 30x model, x1 to x30 optical zoom, x90 HD EX optical zoom, and more (up to x480) digital zoom are performed.
- Optical zoom: For a 32x model, x1 to x32 optical zoom, x48 HD EX optical zoom, and more (up to x512) digital zoom are performed.
- Optical zoom: For a 40x model, x1 to x40 optical zoom, x60 HD EX optical zoom, and more (up to x640) digital zoom are performed.

**[Note:]**

When [On] is set to Digital Zoom, it stops once just before the Digital Zoom magnification changes during the zoom operation.

The preset position cannot be set with the digital zoom factor.

If [HD Extra optical zoom] is [Off], [Digital zoom] cannot be set to [On].

[Camera position display]

Select the information displayed in the image during manual operation from the following.

[Off]:The information is not displayed in the image.

[Pan tilt angle/magnification display]:Displays pan angle/tilt angle/magnification.

[Directional view]:Displays the direction.

**[Note:]**

When set to · [Pan·Tilt degree/Zoom ratio display], the pan tilt angles/magnifications are displayed in the [Camera title position] set on the Basic Page [Basic] tab.

→ [10.2.6 Setting of pan/tilt range \(pan/tilt range setting screen\)](#)

When set to · [Direction display], the orientation is displayed in the [Camera title position] you set on the [Basic] tab of the basic page.

→ [10.2.5 Setting for direction/direction setting \(direction/direction setting screen\)](#)

To select · [Direction display], set the reference northern direction with the [Direction/Angle setting] [North point setting].

→ [10.2.5 Setting for direction/direction setting \(direction/direction setting screen\)](#)

[Operation mode display]

Displays the operation mode when the camera is running automatically.

[On]:Displays the operating mode.

[Off]:The operation mode is not displayed.

| Operation mode | Display |
|----------------------------------|---------------|
| During startup | INITIAL |
| During auto pan | AUTO PAN |
| Automatic tracking (in progress) | AUTO TRACKING |
| During patrol | PATROL |
| During the preset sequence | PRESET SEQ |

[Tilt-flip]

Select the tilt-flip setting from the following.

[On]:When the tilt end point (directly below) is reached during manual operation, the pan can be automatically rotated at a high speed to continue operation without stopping at the tilt end point.

[Off]:The tilt-flip function does not work.



[Note:]

- Even if the tilt-flip function is activated on the TELE side, some parts are not visible.

In the main area of the Live image pages, clicking the desired position for the center of the field angle moves the orientation of the camera to the center of the clicked position. In this case, the product continues to operate without stopping at the tilt end point.

- During flip movement, the image being moved is displayed.

[Tilt Angle]

Select the angle limit of tilt operation from the following. (Horizontal = 0°)

10° / 5° / 3° / 0° / -3° / -5° / -10° / -15° / -20° / -25° / -30°



[Note:]

The screen may be partially darkened if it is directed above-20 degrees.

[Maximum optical zoom speed]

Select the maximum speed of the optical zoom.

[High]/[Mid]/[Low]

[Maximum panning/tilting speed]

Select the maximum speed for pan tilt operation.

[1° /s], [2° /s], [5° /s], [10° /s], [25° /s], [50° /s], [90° /s], [135° /s], [150° /s], [300° /s], [400° /s], [500° /s], [600° /s], [Unlimited]

[Focus distance]

If you have a object over the window or a different object over a short distance, it may be difficult to focus on the object you want to view. If the camera is not focused properly, you can limit the shortest shooting distance.

[Unlimited]/[1.5m]/ [3m]/ [5m]/ [10m]

[Auto position refresh]

Turning on the Auto position refresh, when the panning (turning) angle deviates by a certain amount, so that it will automatically shift to the positive position.

[On]:Perform position refresh automatically.

[Off]:Not perform position refresh automatically.

10.1.2 [Cam. Function] for setting the operation of Indoor PTZ cameras

| Cam. Function | Position | Auto track | Auto track alarm setting |
|-------------------------------|---------------------------------------------------------------|------------|--------------------------|
| Basic settings | | | |
| Home position | Off ▾ | | |
| Self return | Off ▾ | | |
| Self return time | 1min. ▾ | | |
| Upside-down | <input type="radio"/> On <input checked="" type="radio"/> Off | | |
| Maximum optical zoom ratio | Unlimited ▾ | | |
| Digital zoom | <input checked="" type="radio"/> On <input type="radio"/> Off | | |
| Camera position display | Pan-Tilt degree/Zoom ratio display ▾ | | |
| Operation mode display | <input type="radio"/> On <input checked="" type="radio"/> Off | | |
| Pan/tilt-flip | <input checked="" type="radio"/> On <input type="radio"/> Off | | |
| Tilt Angle | 0° ▾ | | |
| Set | | | |
| Advanced setting | | | |
| Maximum optical zoom speed | High ▾ | | |
| Maximum panning/tilting speed | Unlimited ▾ | | |
| Pan/Tilt Operability | Profile1(Normal) ▾ | | |
| Focus distance | Unlimited ▾ | | |
| Set | | | |

[Home position]

You can set the preset position as the home position.

When the home position is set, [H] is displayed next to the preset position number.

→[10.2.1 Set the preset position \(preset position setting screen\)](#)



[Note:]

If you want to move to the home position when the power is turned on, set [HomePosition] to [Self return].

[Self return]

When the time set by [Self return time] has elapsed after manual operation, the camera can automatically return to one of the following modes of operation.

[Off]: Do not perform self-return.

[Home position]: After the set time has elapsed, the watch returns to the home position.

[Auto Pan]: When the set time elapses, the auto pan operation starts.

[Preset Sequence 1]: When the set time elapses, Sequence 1 operation starts.

[Preset Sequence 2]: Sequence 2 operation starts when the set time elapses.

[Preset Sequence 3]: Sequence 3 operation starts when the set time elapses.

[Patrol]: When the set time elapses, the patrol operation starts.

**[Note:]**

If you want to perform the above operations when turning on the power, it is convenient to use the self-turn function.

The Self-turn function works even when the Setup menu is displayed.

- [Patrol] can be set only when patrols are set.

→ [10.2.4 Set patrol \(Patrol function setting screen\)](#)

- [Preset sequence] can be set only when the preset sequence is set.

→ [10.2.2 Set the preset sequence setting \(preset sequence setting screen\)](#)

[Self return time]

After the manual operation is completed, select the time from the following to return to the operation set by [Self return].

[10s]/ [20s]/ [30s]/ [1min]/ [2min]/ [3min]/ [5min]/ [10min]/ [20min]/ [30min]/ [60min]

[Upside-down]

Use [On] or [Off] to set whether to flip the images up or down.

[On]: The image is inverted upside down.

[Off]: The image is not flipped up or down.

[Maximum optical zoom ratio]

Select the maximum zoom ratio for the optical zoom from the following. Refer to the catalog specifications for the installed optical zoom ratio.

- Optical zoom: 30x model x1/x2/x3/x4/x5/x6/x7/x8/x9/x10/x11/x12/x13/x14/x15/x16/x17/x18/x19/x20/x21/x22/x24/x26/x27/x28/x29/unlimited

[Digital zoom]

Select the digital zoom setting from the following.

[On]: When the optical zoom is exceeded, digital zoom is performed.

[Off]: Digital zoom is not performed.

About Digital zoom

- Optical zoom: For a 30x model, x1 to x30 optical zoom, x90 HD EX optical zoom, and more (up to x480) digital zoom are performed.

**[Note:]**

- When [On] is set to Digital Zoom, it stops once just before the Digital Zoom magnification changes during the zoom operation.
- The preset position cannot be set with the digital zoom factor.
- Refer to the catalog specifications for the maximum digital zoom ratio.

[Camera position display]

Select the information displayed in the image during manual operation from the following.

[Off]:The information is not displayed in the image.

[Pan tilt angle/magnification display]:Displays pan angle/tilt angle/magnification.

[Directional view]:Displays the direction.

**[Note:]**

When set to · [Pan·Tilt degree/Zoom ratio display], the pan tilt angles/magnifications are displayed in the [Camera title position] set on the Basic Page [Basic] tab.

→ [10.2.6 Setting of pan/tilt range \(pan/tilt range setting screen\)](#)

When set to · [Direction display], the orientation is displayed in the [Camera title position] you set on the [Basic] tab of the basic page.

→ [10.2.5 Setting for direction/direction setting \(direction/direction setting screen\)](#)

To select · [Direction display], set the reference northern direction with the [Direction/Angle setting] [North point setting].

→ [10.2.5 Setting for direction/direction setting \(direction/direction setting screen\)](#)

[Operation mode display]

Displays the operation mode when the camera is running automatically.

[On]:Displays the operating mode.

[Off]:The operation mode is not displayed.

| Operation mode | Display |
|----------------------------------|---------------|
| During startup | INITIAL |
| During auto pan | AUTO PAN |
| Automatic tracking (in progress) | AUTO TRACKING |
| During patrol | PATROL |

| | |
|----------------------------|------------|
| During the preset sequence | PRESET SEQ |
|----------------------------|------------|

[Pan/tilt-flip]

Select the pan/tilt flip setting from the following.

[On]:When the pan end point and the tilt end point (directly below) are reached during manual operation, the pan can be automatically rotated at high speed to continue operation without stopping at the pan end point and the tilt end point.

[Off]:The pan/tilt flip function does not work.



[Note:]

On the TELE side, some parts are not visible even when the pan/tilt flip function is activated.

In the main area of the live image page, clicking the desired position for the center of the field angle moves the camera's orientation to the center of the clicked position. In this case, the operation continues without stopping at the pan tilt end point.

- During flip movement, the image being moved is displayed.

[Tilt Angle]

Select the angle limit of tilt operation from the following. (Horizontal = 0°)

10° / 5° / 3° / 0° / -3° / -5° / -10° / -15° / -20° / -25°



[Note:]

The screen may be partially darkened if it is directed above-20 degrees.

[Maximum optical zoom speed]

Select the maximum speed of the optical zoom.

[High]/[Mid]/[Low]

[Maximum panning/tilting speed]

Select the maximum speed for pan tilt operation.

[1° /s], [2° /s], [5° /s], [10° /s], [25° /s], [50° /s], [90° /s], [135° /s], [150° /s], [300° /s], [Unlimited]

[Focus distance]

If you have a object over the window or a different object over a short distance, it may be difficult to focus on the object you want to view. If the camera is not focused properly, you can limit the shortest shooting distance.

[Unlimited]/ [3m]/ [5m]/ [10m]

10.2 [Position] for setting positions

Click on the [Position] tab of the PTZ page. Refer to the following how to display and operate the Advanced menu.

→5.1 [How to display](#)

→5.2 [How to operate](#)

To Advanced Settings for each item>>Clicking this button displays the advanced settings window in a separate window and allows you to set the settings while viewing the images displayed on the [Position] tab.

Here, you can set the image quality adjustment, preset position, preset sequence setting, auto pan, patrol, direction/direction setting, and pan/tilt range setting.

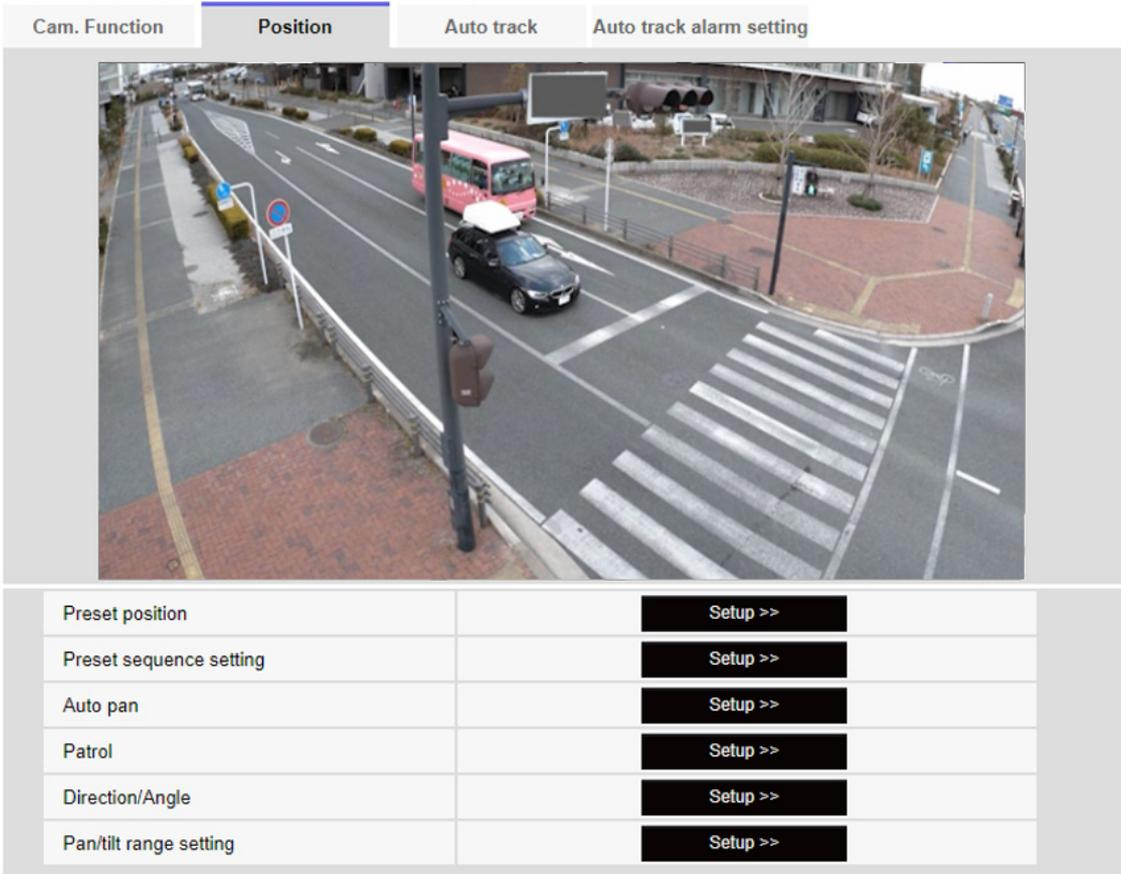

The screenshot shows the PTZ interface with the 'Position' tab selected. The main view is a live camera feed of a street intersection. Below the feed is a table of settings:

| Cam. Function | Position | Auto track | Auto track alarm setting |
|-------------------------|--------------------------------------------------------------------------------------|------------|--------------------------------|
| |  | | |
| Preset position | | | Setup >> |
| Preset sequence setting | | | Setup >> |
| Auto pan | | | Setup >> |
| Patrol | | | Setup >> |
| Direction/Angle | | | Setup >> |
| Pan/tilt range setting | | | Setup >> |

[Preset position]

To Advanced Settings>>When the button is clicked, the preset position setting window is

displayed in a separate window.

→[10.2.1 Set the preset position \(preset position setting screen\)](#)

[Preset sequence setting]

To Advanced Settings>>When the [button] is clicked, the preset sequence settings window is displayed in a separate window.

→[10.2.2 Set the preset sequence setting \(preset sequence setting screen\)](#)

[Auto pan]

To Advanced Settings>>Click the [Auto Pan] button to display the auto pan setting window in a separate window.

→[10.2.3 Set auto pan \(Auto pan setting screen\)](#)

[Patrol]

To Advanced Settings>>When the [Patrol] button is clicked, the setting window for the patrol is displayed in another window.

→[10.2.4 Set patrol \(Patrol function setting screen\)](#)

[Direction/Angle]

To Advanced Settings>>When the button is clicked, the setting window for direction/direction setting is displayed in a separate window.

→[10.2.5 Setting for direction/direction setting \(direction/direction setting screen\)](#)

[Pan/tilt range setting]

To Advanced Settings>>Click the [Button] button to open a window for specifying the pan/tilt range.

→[10.2.6 Setting of pan/tilt range \(pan/tilt range setting screen\)](#)

10.2.1 Set the preset position (preset position setting screen)

In the [Position] tab of the PTZ-page to the Advanced Settings tab of [Preset position]>>Click the [Button].

→[10.2 \[Position\] for setting positions](#)

Here, you can register, change, or delete the preset position.

If you adjust the focus, brightness, zoom, etc., the images on the [Position] tabs will be reflected at the same time.

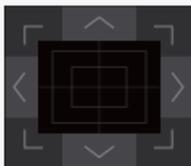
| | |
|------------------------------------------------------------------------------------------------------------------------------------------------------------------------------------------------------------------|--------------------------------------------------------------------------------------------------------------|
| Preset No. | <input type="text"/> |
| Position No. | |
| Preset ID | <input type="radio"/> On <input type="radio"/> Off |
| Preset ID (0 – 9,A – Z) | <input type="text"/> |
| Auto focus | <input type="radio"/> Auto <input type="radio"/> Off |
| Dwell time | <input type="text"/> |
| <input type="button" value="Set"/> <input type="button" value="Delete"/> | |
| *Any changes are updated immediately | |
| Super Dynamic | <input type="radio"/> On <input type="radio"/> Off |
| Level | <input type="range"/> <input type="button" value="Reset"/> |
| BLC/ HLC | <input type="text"/> |
| BLC level | <input type="range"/> <input type="button" value="Reset"/> |
| HLC level | <input type="range"/> <input type="button" value="Reset"/> |
| Mask area | <input type="button" value="Start"/> <input type="button" value="End"/> <input type="button" value="Reset"/> |
| Zoom <input type="button" value="⊖"/> <input type="button" value="1"/> <input type="button" value="⊕"/> | |
| Focus <input type="button" value="Auto"/> <input type="button" value="Near"/> <input type="button" value="Far"/> | |
| Brightness <input type="button" value="-"/> <input type="button" value="Normal"/> <input type="button" value="+"/>  | |
| <input type="button" value="Close"/> | |



[Important]

- Do not change other settings during preset position setting. The image may not be displayed correctly.
- The preset position cannot be set with the magnification of the digital zoom.
- Up to 256 preset positions can be set.



[Note:]

- Depending on the operating environment (+5 ° C or less as a guideline), the speed of the preset movement may be slightly slower.

Preset position setting

[Preset ID]

Use [On] and [Off] to set whether the position name is displayed. You can set for each preset position.

[On]:Displays the position name.

[Off]:The position name is not displayed.



[Important]

- If you have configured [Preset ID (0 – 9,A – Z)] and [Preset ID], be sure to press [Register].



[Note:]

- When set to [On], the position name is displayed where you set the position in [Camera title position] on the [Basic] tab.

[Preset ID (0 - 9,A - Z)]

Enter the name to be displayed on the image. You can set for each preset position.

Number of characters that can be entered:0 to 40 characters

Input Characters:0-9 (single-byte), A-Z (single-byte, uppercase, lowercase), double-byte, single-byte symbol ! " # \$ % & ' () * + , - . / : ; = ?



[Note:]

- The position name entered is displayed next to the preset position number in the pull-down. If [Preset ID] is set to [On], it can also be displayed on the images.

[Auto focus]

Use [Auto] and [Off] to set whether auto focus is performed after the preset is moved. You can set for each preset position.

[Auto]:Auto focus is performed after the preset is moved.

[Off]:Auto focus is not performed after moving the preset.

**[Note:]**

- When presetting a subject whose depth does not change, a subject whose contrast is low, or a subject with high brightness such as a spotlight, etc., set [Off] and register the preset position after setting the focus.

[Dwell time]

During the preset sequence operation, select the time to reflect the image of each preset position (the time when the camera stops rotating) from the following.

[5s]/ [10s]/ [15s]/ [20s]/ [25s]/ [30s]

**[Note:]**

- The preset position set to [Off] does not move to that position during the preset sequence, but instead moves to the next preset position.
- Depending on the stop time setting, the watch may move to the next preset position during auto focus operation.
- If the preset sequence function is used for a long time, the drive parts may be consumed and the replacement cycle of consumables may be faster. For consumables, refer to the Web Guide.

[Super Dynamic]

You can set [On] or [Off] to activate the super dynamic function. You can set for each preset position.

This cannot be set when [Image capture mode] is [16:9 mode(60fps mode)] or [16:9 mode(50fps mode)].

See [What is Super Dynamic] for details on super dynamic.

[On]:The Super Dynamic function is activated.

[Off]:Stops the superdynamic function.

**[Note:]**

- Set [Super Dynamic] to [Off] when the following phenomena are observed depending on the lighting condition.
 - when flickering or color changes occur
 - when noise is generated in the bright area of the screen
- If [Light control mode] is set to [Fix shutter], [Super Dynamic] cannot be set to [On].
- When [Stabilizer] is set to [On], the superdynamic setting is [Off].
- [Rapid PTZ-8M (4K)][Rapid PTZ-6M]If you switch the [Super Dynamic] from [On] to [Off] or from [Off] to [On], the images may be distorted.

[Level]

Adjust the superdynamic level.

When the slider bar is moved in the [+] direction, you can shoot a subject with a large difference in light and darkness without flipping white or shading black.

Move the slider bar in the [-] direction to take a full picture of the middle brightness.

Press [Reset] to return to the default settings.

**[Note:]**

- Depending on [Image adjust]'s [Super Dynamic] and [Level] settings, [Preset position]'s [Super Dynamic] and [Level] operations may change.

→9.4.1 [To adjust the image quality \(image quality adjustment screen\)](#)

[BLC/ HLC]

Select from the following. This setting is not available if [Super Dynamic] is set to [On] or [Intelligent Auto] is set to [On].

[Back Light Correction (BLC)]: Enables the backlight correction function.

[Intensity correction]: Enables the high light correction function. Illumination compensation suppresses bright lighting of subjects such as car headlights during nighttime.

[Off]: Stops the backlight compensation function and the intense light correction function.

[BLC level]

Adjust the backlight correction level.

Moving the slider bar in the [+] direction improves the backlight correction effect.

Moving the slider bar in the [-] direction reduces the effect of backlight correction.

Press [Reset] to return to the default settings.

[HLC level]

Adjust the intensity correction level.

Moving the slider bar in the [+] direction improves the effect of intense light correction.

Moving the slider bar in the [-] direction reduces the effect of intense light correction.

Press [Reset] to return to the default settings.

[Mask area]

When the mask area is set, the set area can be masked and the light intensity can be adjusted. If [Super Dynamic] is set to [On], it cannot be set.

For details on how to set the mask area, refer to the following.

→9.4.2 [Set the mask area](#)

[Zoom], [Focus], Control Pad/Button, [Brightness] Button

Please refer to the following instructions for operation.

→[9.4.6 Setting the privacy zone \(Privacy zone setting screen\)](#)

[Set] buttons

Register the preset position.

[Delete] buttons

Deletes the preset position selected by the position number.

[Close] buttons

Click this button to close the preset position setting window.

Register the preset position

- 1 Select the position number.

[Position No.] shows the selected position number.

→[10.2.1 Set the preset position \(preset position setting screen\)](#)

If it is already registered, the camera moves to the preset position selected.

- 2 Move the camera direction in the direction you want to register.
- 3 If you want the position name to appear on the live image page, set [Preset ID] to [On] and enter the position name.
- 4 Set Auto Focus or Stop Time.
- 5 Press [Register].
- 6 To set image quality for each position, set each item such as Super Dynamic. [Super Dynamic], [BLC/ HLC], and [Mask area] are reflected immediately.



[Note:]

- When registering the preset position, the camera may move slightly.
- If [Image adjust] [Scene file] is set to other than [Scene file is not applied], [Super Dynamic], [BLC/ HLC], and [Mask area] cannot be set.

10.2.2 Set the preset sequence setting (preset sequence setting screen)

To [Preset sequence setting] Advanced Settings on the [Position] tabs of PTZ pages>>Click the [Button].

→[10.2 \[Position\] for setting positions](#)

Here, you can register, change, or delete the preset sequence.

Up to three preset sequences can be set.

Preset sequence setting

- +Preset sequence 1
- +Preset sequence 2
- +Preset sequence 3

Preset sequence setting

Preset sequence setting

-Preset sequence 1

| Select all | Cancel all | | | | | | | |
|--------------------------|--------------------------|--------------------------|--------------------------|--------------------------|--------------------------|--------------------------|--------------------------|--------------------------|
| <input type="checkbox"/> | <input type="checkbox"/> | <input type="checkbox"/> | <input type="checkbox"/> | <input type="checkbox"/> | <input type="checkbox"/> | <input type="checkbox"/> | <input type="checkbox"/> | <input type="checkbox"/> |
| <input type="checkbox"/> | <input type="checkbox"/> | <input type="checkbox"/> | <input type="checkbox"/> | <input type="checkbox"/> | <input type="checkbox"/> | <input type="checkbox"/> | <input type="checkbox"/> | <input type="checkbox"/> |
| <input type="checkbox"/> | <input type="checkbox"/> | <input type="checkbox"/> | <input type="checkbox"/> | <input type="checkbox"/> | <input type="checkbox"/> | <input type="checkbox"/> | <input type="checkbox"/> | <input type="checkbox"/> |
| <input type="checkbox"/> | <input type="checkbox"/> | <input type="checkbox"/> | <input type="checkbox"/> | <input type="checkbox"/> | <input type="checkbox"/> | <input type="checkbox"/> | <input type="checkbox"/> | <input type="checkbox"/> |
| <input type="checkbox"/> | <input type="checkbox"/> | <input type="checkbox"/> | <input type="checkbox"/> | <input type="checkbox"/> | <input type="checkbox"/> | <input type="checkbox"/> | <input type="checkbox"/> | <input type="checkbox"/> |
| <input type="checkbox"/> | <input type="checkbox"/> | <input type="checkbox"/> | <input type="checkbox"/> | <input type="checkbox"/> | <input type="checkbox"/> | <input type="checkbox"/> | <input type="checkbox"/> | <input type="checkbox"/> |
| <input type="checkbox"/> | <input type="checkbox"/> | <input type="checkbox"/> | <input type="checkbox"/> | <input type="checkbox"/> | <input type="checkbox"/> | <input type="checkbox"/> | <input type="checkbox"/> | <input type="checkbox"/> |
| <input type="checkbox"/> | <input type="checkbox"/> | <input type="checkbox"/> | <input type="checkbox"/> | <input type="checkbox"/> | <input type="checkbox"/> | <input type="checkbox"/> | <input type="checkbox"/> | <input type="checkbox"/> |
| <input type="checkbox"/> | <input type="checkbox"/> | <input type="checkbox"/> | <input type="checkbox"/> | <input type="checkbox"/> | <input type="checkbox"/> | <input type="checkbox"/> | <input type="checkbox"/> | <input type="checkbox"/> |
| <input type="checkbox"/> | <input type="checkbox"/> | <input type="checkbox"/> | <input type="checkbox"/> | <input type="checkbox"/> | <input type="checkbox"/> | <input type="checkbox"/> | <input type="checkbox"/> | <input type="checkbox"/> |
| <input type="checkbox"/> | <input type="checkbox"/> | <input type="checkbox"/> | <input type="checkbox"/> | <input type="checkbox"/> | <input type="checkbox"/> | <input type="checkbox"/> | <input type="checkbox"/> | <input type="checkbox"/> |
| <input type="checkbox"/> | <input type="checkbox"/> | <input type="checkbox"/> | <input type="checkbox"/> | <input type="checkbox"/> | <input type="checkbox"/> | <input type="checkbox"/> | <input type="checkbox"/> | <input type="checkbox"/> |
| <input type="checkbox"/> | <input type="checkbox"/> | <input type="checkbox"/> | <input type="checkbox"/> | <input type="checkbox"/> | <input type="checkbox"/> | <input type="checkbox"/> | <input type="checkbox"/> | <input type="checkbox"/> |
| <input type="checkbox"/> | <input type="checkbox"/> | <input type="checkbox"/> | <input type="checkbox"/> | <input type="checkbox"/> | <input type="checkbox"/> | <input type="checkbox"/> | <input type="checkbox"/> | <input type="checkbox"/> |
| <input type="checkbox"/> | <input type="checkbox"/> | <input type="checkbox"/> | <input type="checkbox"/> | <input type="checkbox"/> | <input type="checkbox"/> | <input type="checkbox"/> | <input type="checkbox"/> | <input type="checkbox"/> |
| <input type="checkbox"/> | <input type="checkbox"/> | <input type="checkbox"/> | <input type="checkbox"/> | <input type="checkbox"/> | <input type="checkbox"/> | <input type="checkbox"/> | <input type="checkbox"/> | <input type="checkbox"/> |
| <input type="checkbox"/> | <input type="checkbox"/> | <input type="checkbox"/> | <input type="checkbox"/> | <input type="checkbox"/> | <input type="checkbox"/> | <input type="checkbox"/> | <input type="checkbox"/> | <input type="checkbox"/> |
| <input type="checkbox"/> | <input type="checkbox"/> | <input type="checkbox"/> | <input type="checkbox"/> | <input type="checkbox"/> | <input type="checkbox"/> | <input type="checkbox"/> | <input type="checkbox"/> | <input type="checkbox"/> |
| <input type="checkbox"/> | <input type="checkbox"/> | <input type="checkbox"/> | <input type="checkbox"/> | <input type="checkbox"/> | <input type="checkbox"/> | <input type="checkbox"/> | <input type="checkbox"/> | <input type="checkbox"/> |
| <input type="checkbox"/> | <input type="checkbox"/> | <input type="checkbox"/> | <input type="checkbox"/> | <input type="checkbox"/> | <input type="checkbox"/> | <input type="checkbox"/> | <input type="checkbox"/> | <input type="checkbox"/> |
| <input type="checkbox"/> | <input type="checkbox"/> | <input type="checkbox"/> | <input type="checkbox"/> | <input type="checkbox"/> | <input type="checkbox"/> | <input type="checkbox"/> | <input type="checkbox"/> | <input type="checkbox"/> |
| <input type="checkbox"/> | <input type="checkbox"/> | <input type="checkbox"/> | <input type="checkbox"/> | <input type="checkbox"/> | <input type="checkbox"/> | <input type="checkbox"/> | <input type="checkbox"/> | <input type="checkbox"/> |
| <input type="checkbox"/> | <input type="checkbox"/> | <input type="checkbox"/> | <input type="checkbox"/> | <input type="checkbox"/> | <input type="checkbox"/> | <input type="checkbox"/> | <input type="checkbox"/> | <input type="checkbox"/> |
| <input type="checkbox"/> | <input type="checkbox"/> | <input type="checkbox"/> | <input type="checkbox"/> | <input type="checkbox"/> | <input type="checkbox"/> | <input type="checkbox"/> | <input type="checkbox"/> | <input type="checkbox"/> |
| <input type="checkbox"/> | <input type="checkbox"/> | <input type="checkbox"/> | <input type="checkbox"/> | <input type="checkbox"/> | <input type="checkbox"/> | <input type="checkbox"/> | <input type="checkbox"/> | <input type="checkbox"/> |
| <input type="checkbox"/> | <input type="checkbox"/> | <input type="checkbox"/> | <input type="checkbox"/> | <input type="checkbox"/> | <input type="checkbox"/> | <input type="checkbox"/> | <input type="checkbox"/> | <input type="checkbox"/> |
| <input type="checkbox"/> | <input type="checkbox"/> | <input type="checkbox"/> | <input type="checkbox"/> | <input type="checkbox"/> | <input type="checkbox"/> | <input type="checkbox"/> | <input type="checkbox"/> | <input type="checkbox"/> |
| <input type="checkbox"/> | <input type="checkbox"/> | <input type="checkbox"/> | <input type="checkbox"/> | <input type="checkbox"/> | <input type="checkbox"/> | <input type="checkbox"/> | <input type="checkbox"/> | <input type="checkbox"/> |
| <input type="checkbox"/> | <input type="checkbox"/> | <input type="checkbox"/> | <input type="checkbox"/> | <input type="checkbox"/> | <input type="checkbox"/> | <input type="checkbox"/> | <input type="checkbox"/> | <input type="checkbox"/> |
| <input type="checkbox"/> | <input type="checkbox"/> | <input type="checkbox"/> | <input type="checkbox"/> | <input type="checkbox"/> | <input type="checkbox"/> | <input type="checkbox"/> | <input type="checkbox"/> | <input type="checkbox"/> |
| <input type="checkbox"/> | <input type="checkbox"/> | <input type="checkbox"/> | <input type="checkbox"/> | <input type="checkbox"/> | <input type="checkbox"/> | <input type="checkbox"/> | <input type="checkbox"/> | <input type="checkbox"/> |
| <input type="checkbox"/> | <input type="checkbox"/> | <input type="checkbox"/> | <input type="checkbox"/> | <input type="checkbox"/> | <input type="checkbox"/> | <input type="checkbox"/> | <input type="checkbox"/> | <input type="checkbox"/> |
| <input type="checkbox"/> | <input type="checkbox"/> | <input type="checkbox"/> | <input type="checkbox"/> | <input type="checkbox"/> | <input type="checkbox"/> | <input type="checkbox"/> | <input type="checkbox"/> | <input type="checkbox"/> |
| <input type="checkbox"/> | <input type="checkbox"/> | <input type="checkbox"/> | <input type="checkbox"/> | <input type="checkbox"/> | <input type="checkbox"/> | <input type="checkbox"/> | <input type="checkbox"/> | <input type="checkbox"/> |
| <input type="checkbox"/> | <input type="checkbox"/> | <input type="checkbox"/> | <input type="checkbox"/> | <input type="checkbox"/> | <input type="checkbox"/> | <input type="checkbox"/> | <input type="checkbox"/> | <input type="checkbox"/> |
| <input type="checkbox"/> | <input type="checkbox"/> | <input type="checkbox"/> | <input type="checkbox"/> | <input type="checkbox"/> | <input type="checkbox"/> | <input type="checkbox"/> | <input type="checkbox"/> | <input type="checkbox"/> |
| <input type="checkbox"/> | <input type="checkbox"/> | <input type="checkbox"/> | <input type="checkbox"/> | <input type="checkbox"/> | <input type="checkbox"/> | <input type="checkbox"/> | <input type="checkbox"/> | <input type="checkbox"/> |
| <input type="checkbox"/> | <input type="checkbox"/> | <input type="checkbox"/> | <input type="checkbox"/> | <input type="checkbox"/> | <input type="checkbox"/> | <input type="checkbox"/> | <input type="checkbox"/> | <input type="checkbox"/> |
| <input type="checkbox"/> | <input type="checkbox"/> | <input type="checkbox"/> | <input type="checkbox"/> | <input type="checkbox"/> | <input type="checkbox"/> | <input type="checkbox"/> | <input type="checkbox"/> | <input type="checkbox"/> |
| <input type="checkbox"/> | <input type="checkbox"/> | <input type="checkbox"/> | <input type="checkbox"/> | <input type="checkbox"/> | <input type="checkbox"/> | <input type="checkbox"/> | <input type="checkbox"/> | <input type="checkbox"/> |
| <input type="checkbox"/> | <input type="checkbox"/> | <input type="checkbox"/> | <input type="checkbox"/> | <input type="checkbox"/> | <input type="checkbox"/> | <input type="checkbox"/> | <input type="checkbox"/> | <input type="checkbox"/> |
| <input type="checkbox"/> | <input type="checkbox"/> | <input type="checkbox"/> | <input type="checkbox"/> | <input type="checkbox"/> | <input type="checkbox"/> | <input type="checkbox"/> | <input type="checkbox"/> | <input type="checkbox"/> |
| <input type="checkbox"/> | <input type="checkbox"/> | <input type="checkbox"/> | <input type="checkbox"/> | <input type="checkbox"/> | <input type="checkbox"/> | <input type="checkbox"/> | <input type="checkbox"/> | <input type="checkbox"/> |
| <input type="checkbox"/> | <input type="checkbox"/> | <input type="checkbox"/> | <input type="checkbox"/> | <input type="checkbox"/> | <input type="checkbox"/> | <input type="checkbox"/> | <input type="checkbox"/> | <input type="checkbox"/> |
| <input type="checkbox"/> | <input type="checkbox"/> | <input type="checkbox"/> | <input type="checkbox"/> | <input type="checkbox"/> | <input type="checkbox"/> | <input type="checkbox"/> | <input type="checkbox"/> | <input type="checkbox"/> |
| <input type="checkbox"/> | <input type="checkbox"/> | <input type="checkbox"/> | <input type="checkbox"/> | <input type="checkbox"/> | <input type="checkbox"/> | <input type="checkbox"/> | <input type="checkbox"/> | <input type="checkbox"/> |
| <input type="checkbox"/> | <input type="checkbox"/> | <input type="checkbox"/> | <input type="checkbox"/> | <input type="checkbox"/> | <input type="checkbox"/> | <input type="checkbox"/> | <input type="checkbox"/> | <input type="checkbox"/> |
| <input type="checkbox"/> | <input type="checkbox"/> | <input type="checkbox"/> | <input type="checkbox"/> | <input type="checkbox"/> | <input type="checkbox"/> | <input type="checkbox"/> | <input type="checkbox"/> | <input type="checkbox"/> |
| <input type="checkbox"/> | <input type="checkbox"/> | <input type="checkbox"/> | <input type="checkbox"/> | <input type="checkbox"/> | <input type="checkbox"/> | <input type="checkbox"/> | <input type="checkbox"/> | <input type="checkbox"/> |
| <input type="checkbox"/> | <input type="checkbox"/> | <input type="checkbox"/> | <input type="checkbox"/> | <input type="checkbox"/> | <input type="checkbox"/> | <input type="checkbox"/> | <input type="checkbox"/> | <input type="checkbox"/> |
| <input type="checkbox"/> | <input type="checkbox"/> | <input type="checkbox"/> | <input type="checkbox"/> | <input type="checkbox"/> | <input type="checkbox"/> | <input type="checkbox"/> | <input type="checkbox"/> | <input type="checkbox"/> |
| <input type="checkbox"/> | <input type="checkbox"/> | <input type="checkbox"/> | <input type="checkbox"/> | <input type="checkbox"/> | <input type="checkbox"/> | <input type="checkbox"/> | <input type="checkbox"/> | <input type="checkbox"/> |
| <input type="checkbox"/> | <input type="checkbox"/> | <input type="checkbox"/> | <input type="checkbox"/> | <input type="checkbox"/> | <input type="checkbox"/> | <input type="checkbox"/> | <input type="checkbox"/> | <input type="checkbox"/> |
| <input type="checkbox"/> | <input type="checkbox"/> | <input type="checkbox"/> | <input type="checkbox"/> | <input type="checkbox"/> | <input type="checkbox"/> | <input type="checkbox"/> | <input type="checkbox"/> | <input type="checkbox"/> |
| <input type="checkbox"/> | <input type="checkbox"/> | <input type="checkbox"/> | <input type="checkbox"/> | <input type="checkbox"/> | <input type="checkbox"/> | <input type="checkbox"/> | <input type="checkbox"/> | <input type="checkbox"/> |
| <input type="checkbox"/> | <input type="checkbox"/> | <input type="checkbox"/> | <input type="checkbox"/> | <input type="checkbox"/> | <input type="checkbox"/> | <input type="checkbox"/> | <input type="checkbox"/> | <input type="checkbox"/> |
| <input type="checkbox"/> | <input type="checkbox"/> | <input type="checkbox"/> | <input type="checkbox"/> | <input type="checkbox"/> | <input type="checkbox"/> | <input type="checkbox"/> | <input type="checkbox"/> | <input type="checkbox"/> |
| <input type="checkbox"/> | <input type="checkbox"/> | <input type="checkbox"/> | <input type="checkbox"/> | <input type="checkbox"/> | <input type="checkbox"/> | <input type="checkbox"/> | <input type="checkbox"/> | <input type="checkbox"/> |
| <input type="checkbox"/> | <input type="checkbox"/> | <input type="checkbox"/> | <input type="checkbox"/> | <input type="checkbox"/> | <input type="checkbox"/> | <input type="checkbox"/> | <input type="checkbox"/> | <input type="checkbox"/> |
| <input type="checkbox"/> | <input type="checkbox"/> | <input type="checkbox"/> | <input type="checkbox"/> | <input type="checkbox"/> | <input type="checkbox"/> | <input type="checkbox"/> | <input type="checkbox"/> | <input type="checkbox"/> |
| <input type="checkbox"/> | <input type="checkbox"/> | <input type="checkbox"/> | <input type="checkbox"/> | <input type="checkbox"/> | <input type="checkbox"/> | <input type="checkbox"/> | <input type="checkbox"/> | <input type="checkbox"/> |
| <input type="checkbox"/> | <input type="checkbox"/> | <input type="checkbox"/> | <input type="checkbox"/> | <input type="checkbox"/> | <input type="checkbox"/> | <input type="checkbox"/> | <input type="checkbox"/> | <input type="checkbox"/> |
| <input type="checkbox"/> | <input type="checkbox"/> | <input type="checkbox"/> | <input type="checkbox"/> | <input type="checkbox"/> | <input type="checkbox"/> | <input type="checkbox"/> | <input type="checkbox"/> | <input type="checkbox"/> |
| <input type="checkbox"/> | <input type="checkbox"/> | <input type="checkbox"/> | <input type="checkbox"/> | <input type="checkbox"/> | <input type="checkbox"/> | <input type="checkbox"/> | <input type="checkbox"/> | <input type="checkbox"/> |
| <input type="checkbox"/> | <input type="checkbox"/> | <input type="checkbox"/> | <input type="checkbox"/> | <input type="checkbox"/> | <input type="checkbox"/> | <input type="checkbox"/> | <input type="checkbox"/> | <input type="checkbox"/> |
| <input type="checkbox"/> | <input type="checkbox"/> | <input type="checkbox"/> | <input type="checkbox"/> | <input type="checkbox"/> | <input type="checkbox"/> | <input type="checkbox"/> | <input type="checkbox"/> | <input type="checkbox"/> |
| <input type="checkbox"/> | <input type="checkbox"/> | <input type="checkbox"/> | <input type="checkbox"/> | <input type="checkbox"/> | <input type="checkbox"/> | <input type="checkbox"/> | <input type="checkbox"/> | <input type="checkbox"/> |
| <input type="checkbox"/> | <input type="checkbox"/> | <input type="checkbox"/> | <input type="checkbox"/> | <input type="checkbox"/> | <input type="checkbox"/> | <input type="checkbox"/> | <input type="checkbox"/> | <input type="checkbox"/> |
| <input type="checkbox"/> | <input type="checkbox"/> | <input type="checkbox"/> | <input type="checkbox"/> | <input type="checkbox"/> | <input type="checkbox"/> | <input type="checkbox"/> | <input type="checkbox"/> | <input type="checkbox"/> |
| <input type="checkbox"/> | <input type="checkbox"/> | <input type="checkbox"/> | <input type="checkbox"/> | <input type="checkbox"/> | <input type="checkbox"/> | <input type="checkbox"/> | <input type="checkbox"/> | <input type="checkbox"/> |
| <input type="checkbox"/> | <input type="checkbox"/> | <input type="checkbox"/> | <input type="checkbox"/> | <input type="checkbox"/> | <input type="checkbox"/> | <input type="checkbox"/> | <input type="checkbox"/> | <input type="checkbox"/> |
| <input type="checkbox"/> | <input type="checkbox"/> | <input type="checkbox"/> | <input type="checkbox"/> | <input type="checkbox"/> | <input type="checkbox"/> | <input type="checkbox"/> | <input type="checkbox"/> | <input type="checkbox"/> |
| <input type="checkbox"/> | <input type="checkbox"/> | <input type="checkbox"/> | <input type="checkbox"/> | <input type="checkbox"/> | <input type="checkbox"/> | <input type="checkbox"/> | <input type="checkbox"/> | <input type="checkbox"/> |
| <input type="checkbox"/> | <input type="checkbox"/> | <input type="checkbox"/> | <input type="checkbox"/> | <input type="checkbox"/> | <input type="checkbox"/> | <input type="checkbox"/> | <input type="checkbox"/> | <input type="checkbox"/> |
| <input type="checkbox"/> | <input type="checkbox"/> | <input type="checkbox"/> | <input type="checkbox"/> | <input type="checkbox"/> | <input type="checkbox"/> | <input type="checkbox"/> | <input type="checkbox"/> | <input type="checkbox"/> |
| <input type="checkbox"/> | <input type="checkbox"/> | <input type="checkbox"/> | <input type="checkbox"/> | <input type="checkbox"/> | <input type="checkbox"/> | <input type="checkbox"/> | <input type="checkbox"/> | <input type="checkbox"/> |
| <input type="checkbox"/> | <input type="checkbox"/> | <input type="checkbox"/> | <input type="checkbox"/> | <input type="checkbox"/> | <input type="checkbox"/> | <input type="checkbox"/> | <input type="checkbox"/> | <input type="checkbox"/> |
| <input type="checkbox"/> | <input type="checkbox"/> | <input type="checkbox"/> | <input type="checkbox"/> | <input type="checkbox"/> | <input type="checkbox"/> | <input type="checkbox"/> | <input type="checkbox"/> | <input type="checkbox"/> |
| <input type="checkbox"/> | <input type="checkbox"/> | <input type="checkbox"/> | <input type="checkbox"/> | <input type="checkbox"/> | <input type="checkbox"/> | <input type="checkbox"/> | <input type="checkbox"/> | <input type="checkbox"/> |
| <input type="checkbox"/> | <input type="checkbox"/> | <input type="checkbox"/> | <input type="checkbox"/> | <input type="checkbox"/> | <input type="checkbox"/> | <input type="checkbox"/> | <input type="checkbox"/> | <input type="checkbox"/> |
| <input type="checkbox"/> | <input type="checkbox"/> | <input type="checkbox"/> | <input type="checkbox"/> | <input type="checkbox"/> | <input type="checkbox"/> | <input type="checkbox"/> | <input type="checkbox"/> | <input type="checkbox"/> |
| <input type="checkbox"/> | <input type="checkbox"/> | <input type="checkbox"/> | <input type="checkbox"/> | <input type="checkbox"/> | <input type="checkbox"/> | <input type="checkbox"/> | <input type="checkbox"/> | <input type="checkbox"/> |
| <input type="checkbox"/> | <input type="checkbox"/> | <input type="checkbox"/> | <input type="checkbox"/> | <input type="checkbox"/> | <input type="checkbox"/> | <input type="checkbox"/> | <input type="checkbox"/> | <input type="checkbox"/> |
| <input type="checkbox"/> | <input type="checkbox"/> | <input type="checkbox"/> | <input type="checkbox"/> | <input type="checkbox"/> | <input type="checkbox"/> | <input type="checkbox"/> | <input type="checkbox"/> | <input type="checkbox"/> |
| <input type="checkbox"/> | <input type="checkbox"/> | <input type="checkbox"/> | <input type="checkbox"/> | <input type="checkbox"/> | <input type="checkbox"/> | <input type="checkbox"/> | <input type="checkbox"/> | <input type="checkbox"/> |
| <input type="checkbox"/> | <input type="checkbox"/> | <input type="checkbox"/> | <input type="checkbox"/> | <input type="checkbox"/> | <input type="checkbox"/> | <input type="checkbox"/> | <input type="checkbox"/> | <input type="checkbox"/> |
| <input type="checkbox"/> | <input type="checkbox"/> | <input type="checkbox"/> | <input type="checkbox"/> | <input type="checkbox"/> | <input type="checkbox"/> | <input type="checkbox"/> | <input type="checkbox"/> | <input type="checkbox"/> |
| <input type="checkbox"/> | <input type="checkbox"/> | <input type="checkbox"/> | <input type="checkbox"/> | <input type="checkbox"/> | <input type="checkbox"/> | <input type="checkbox"/> | <input type="checkbox"/> | <input type="checkbox"/> |
| <input type="checkbox"/> | <input type="checkbox"/> | <input type="checkbox"/> | <input type="checkbox"/> | <input type="checkbox"/> | <input type="checkbox"/> | <input type="checkbox"/> | <input type="checkbox"/> | <input type="checkbox"/> |
| <input type="checkbox"/> | <input type="checkbox"/> | <input type="checkbox"/> | <input type="checkbox"/> | <input type="checkbox"/> | <input type="checkbox"/> | <input type="checkbox"/> | <input type="checkbox"/> | <input type="checkbox"/> |
| <input type="checkbox"/> | <input type="checkbox"/> | <input type="checkbox"/> | <input type="checkbox"/> | <input type="checkbox"/> | <input type="checkbox"/> | <input type="checkbox"/> | <input type="checkbox"/> | <input type="checkbox"/> |
| <input type="checkbox"/> | <input type="checkbox"/> | <input type="checkbox"/> | <input type="checkbox"/> | <input type="checkbox"/> | <input type="checkbox"/> | <input type="checkbox"/> | <input type="checkbox"/> | <input type="checkbox"/> |
| <input type="checkbox"/> | <input type="checkbox"/> | <input type="checkbox"/> | <input type="checkbox"/> | <input type="checkbox"/> | <input type="checkbox"/> | <input type="checkbox"/> | <input type="checkbox"/> | <input type="checkbox"/> |
| <input type="checkbox"/> | <input type="checkbox"/> | <input type="checkbox"/> | <input type="checkbox"/> | <input type="checkbox"/> | <input type="checkbox"/> | <input type="checkbox"/> | <input type="checkbox"/> | <input type="checkbox"/> |
| <input type="checkbox"/> | <input type="checkbox"/> | <input type="checkbox"/> | <input type="checkbox"/> | <input type="checkbox"/> | <input type="checkbox"/> | <input type="checkbox"/> | <input type="checkbox"/> | <input type="checkbox"/> |
| <input type="checkbox"/> | <input type="checkbox"/> | <input type="checkbox"/> | <input type="checkbox"/> | <input type="checkbox"/> | <input type="checkbox"/> | <input type="checkbox"/> | <input type="checkbox"/> | <input type="checkbox"/> |
| <input type="checkbox"/> | <input type="checkbox"/> | <input type="checkbox"/> | <input type="checkbox"/> | <input type="checkbox"/> | <input type="checkbox"/> | <input type="checkbox"/> | <input type="checkbox"/> | <input type="checkbox"/> |
| <input type="checkbox"/> | <input type="checkbox"/> | <input type="checkbox"/> | <input type="checkbox"/> | <input type="checkbox"/> | <input type="checkbox"/> | <input type="checkbox"/> | <input type="checkbox"/> | <input type="checkbox"/> |
| <input type="checkbox"/> | <input type="checkbox"/> | <input type="checkbox"/> | <input type="checkbox"/> | <input type="checkbox"/> | <input type="checkbox"/> | <input type="checkbox"/> | <input type="checkbox"/> | <input type="checkbox"/> |
| <input type="checkbox"/> | <input type="checkbox"/> | <input type="checkbox"/> | <input type="checkbox"/> | <input type="checkbox"/> | <input type="checkbox"/> | <input type="checkbox"/> | <input type="checkbox"/> | <input type="checkbox"/> |
| <input type="checkbox"/> | <input type="checkbox"/> | <input type="checkbox"/> | <input type="checkbox"/> | <input type="checkbox"/> | <input type="checkbox"/> | <input type="checkbox"/> | <input type="checkbox"/> | <input type="checkbox"/> |
| <input type="checkbox"/> | <input type="checkbox"/> | <input type="checkbox"/> | <input type="checkbox"/> | <input type="checkbox"/> | <input type="checkbox"/> | <input type="checkbox"/> | <input type="checkbox"/> | <input type="checkbox"/> |
| <input type="checkbox"/> | <input type="checkbox"/> | <input type="checkbox"/> | <input type="checkbox"/> | <input type="checkbox"/> | <input type="checkbox"/> | <input type="checkbox"/> | <input type="checkbox"/> | <input type="checkbox"/> |
| <input type="checkbox"/> | <input type="checkbox"/> | <input type="checkbox"/> | <input type="checkbox"/> | <input type="checkbox"/> | <input type="checkbox"/> | <input type="checkbox"/> | <input type="checkbox"/> | <input type="checkbox"/> |
| <input type="checkbox"/> | <input type="checkbox"/> | <input type="checkbox"/> | <input type="checkbox"/> | <input type="checkbox"/> | <input type="checkbox"/> | <input type="checkbox"/> | <input type="checkbox"/> | <input type="checkbox"/> |
| <input type="checkbox"/> | <input type="checkbox"/> | <input type="checkbox"/> | <input type="checkbox"/> | <input type="checkbox"/> | <input type="checkbox"/> | <input type="checkbox"/> | <input type="checkbox"/> | <input type="checkbox"/> |
| <input type="checkbox"/> | <input type="checkbox"/> | <input type="checkbox"/> | <input type="checkbox"/> | <input type="checkbox"/> | <input type="checkbox"/> | <input type="checkbox"/> | <input type="checkbox"/> | <input type="checkbox"/> |
| <input type="checkbox"/> | <input type="checkbox"/> | <input type="checkbox"/> | <input type="checkbox"/> | <input type="checkbox"/> | <input type="checkbox"/> | <input type="checkbox"/> | <input type="checkbox"/> | <input type="checkbox"/> |
| <input type="checkbox"/> | <input type="checkbox"/> | <input type="checkbox"/> | <input type="checkbox"/> | <input type="checkbox"/> | <input type="checkbox"/> | <input type="checkbox"/> | <input type="checkbox"/> | <input type="checkbox"/> |
| <input type="checkbox"/> | <input type="checkbox"/> | <input type="checkbox"/> | <input type="checkbox"/> | <input type="checkbox"/> | <input type="checkbox"/> | <input type="checkbox"/> | <input type="checkbox"/> | <input type="checkbox"/> |
| <input type="checkbox"/> | <input type="checkbox"/> | <input type="checkbox"/> | <input type="checkbox"/> | <input type="checkbox"/> | <input type="checkbox"/> | <input type="checkbox"/> | <input type="checkbox"/> | <input type="checkbox"/> |
| <input type="checkbox"/> | <input type="checkbox"/> | <input type="checkbox"/> | <input type="checkbox"/> | <input type="checkbox"/> | <input type="checkbox"/> | <input type="checkbox"/> | <input type="checkbox"/> | <input type="checkbox"/> |
| <input type="checkbox"/> | <input type="checkbox"/> | <input type="checkbox"/> | <input type="checkbox"/> | <input type="checkbox"/> | <input type="checkbox"/> | <input type="checkbox"/> | <input type="checkbox"/> | <input type="checkbox"/> |
| <input type="checkbox"/> | <input type="checkbox"/> | <input type="checkbox"/> | <input type="checkbox"/> | <input type="checkbox"/> | <input type="checkbox"/> | <input type="checkbox"/> | <input type="checkbox"/> | <input type="checkbox"/> |
| <input type="checkbox"/> | <input type="checkbox"/> | <input type="checkbox"/> | <input type="checkbox"/> | <input type="checkbox"/> | <input type="checkbox"/> | <input type="checkbox"/> | <input type="checkbox"/> | <input type="checkbox"/> |
| <input type="checkbox"/> | <input type="checkbox"/> | <input type="checkbox"/> | <input type="checkbox"/> | <input type="checkbox"/> | <input type="checkbox"/> | <input type="checkbox"/> | <input type="checkbox"/> | <input type="checkbox"/> |
| <input type="checkbox"/> | <input type="checkbox"/> | <input type="checkbox"/> | <input type="checkbox"/> | <input type="checkbox"/> | <input type="checkbox"/> | <input type="checkbox"/> | <input type="checkbox"/> | <input type="checkbox"/> |
| <input type="checkbox"/> | <input type="checkbox"/> | <input type="checkbox"/> | <input type="checkbox"/> | <input type="checkbox"/> | <input type="checkbox"/> | <input type="checkbox"/> | <input type="checkbox"/> | <input type="checkbox"/> |
| <input type="checkbox"/> | <input type="checkbox"/> | <input type="checkbox"/> | <input type="checkbox"/> | <input type="checkbox"/> | <input type="checkbox"/> | <input type="checkbox"/> | <input type="checkbox"/> | <input type="checkbox"/> |
| <input type="checkbox"/> | <input type="checkbox"/> | <input type="checkbox"/> | <input type="checkbox"/> | <input type="checkbox"/> | <input type="checkbox"/> | <input type="checkbox"/> | <input type="checkbox"/> | <input type="checkbox"/> |
| <input type="checkbox"/> | <input type="checkbox"/> | <input type="checkbox"/> | <input type="checkbox"/> | <input type="checkbox"/> | <input type="checkbox"/> | <input type="checkbox"/> | <input type="checkbox"/> | <input type="checkbox"/> |
| <input type="checkbox"/> | <input type="checkbox"/> | <input type="checkbox"/> | <input type="checkbox"/> | <input type="checkbox"/> | <input type="checkbox"/> | <input type="checkbox"/> | <input type="checkbox"/> | <input type="checkbox"/> |
| <input type="checkbox"/> | <input type="checkbox"/> | <input type="checkbox"/> | <input type="checkbox"/> | <input type="checkbox"/> | <input type="checkbox"/> | <input type="checkbox"/> | <input type="checkbox"/> | <input type="checkbox"/> |
| <input type="checkbox"/> | <input type="checkbox"/> | <input type="checkbox"/> | <input type="checkbox"/> | <input type="checkbox"/> | <input type="checkbox"/> | <input type="checkbox"/> | <input type="checkbox"/> | <input type="checkbox"/> |
| <input type="checkbox"/> | <input type="checkbox"/> | <input type="checkbox"/> | <input type="checkbox"/> | <input type="checkbox"/> | <input type="checkbox"/> | <input type="checkbox"/> | <input type="checkbox"/> | <input type="checkbox"/> |
| <input type="checkbox"/> | <input type="checkbox"/> | <input type="checkbox"/> | <input type="checkbox"/> | <input type="checkbox"/> | <input type="checkbox"/> | <input type="checkbox"/> | <input type="checkbox"/> | <input type="checkbox"/> |
| <input type="checkbox"/> | <input type="checkbox"/> | <input type="checkbox"/> | <input type="checkbox"/> | <input type="checkbox"/> | <input type="checkbox"/> | <input type="checkbox"/> | <input type="checkbox"/> | <input type="checkbox"/> |
| <input type="checkbox"/> | <input type="checkbox"/> | <input type="checkbox"/> | <input type="checkbox"/> | <input type="checkbox"/> | <input type="checkbox"/> | <input type="checkbox"/> | <input type="checkbox"/> | <input type="checkbox"/> |
| <input type="checkbox"/> | <input type="checkbox"/> | <input type="checkbox"/> | <input type="checkbox"/> | <input type="checkbox"/> | <input type="checkbox"/> | <input type="checkbox"/> | <input type="checkbox"/> | <input type="checkbox"/> |
| <input type="checkbox"/> | <input type="checkbox"/> | <input type="checkbox"/> | <input type="checkbox"/> | <input type="checkbox"/> | <input type="checkbox"/> | <input type="checkbox"/> | <input type="checkbox"/> | <input type="checkbox"/> |
| <input type="checkbox"/> | <input type="checkbox"/> | <input type="checkbox"/> | <input type="checkbox"/> | <input type="checkbox"/> | <input type="checkbox"/> | <input type="checkbox"/> | <input type="checkbox"/> | <input type="checkbox"/> |
| <input type="checkbox"/> | <input type="checkbox"/> | <input type="checkbox"/> | <input type="checkbox"/> | <input type="checkbox"/> | <input type="checkbox"/> | <input type="checkbox"/> | <input type="checkbox"/> | <input type="checkbox"/> |
| <input type="checkbox"/> | <input type="checkbox"/> | <input type="checkbox"/> | <input type="checkbox"/> | <input type="checkbox"/> | <input type="checkbox"/> | <input type="checkbox"/> | <input type="checkbox"/> | <input type="checkbox"/> |
| <input type="checkbox"/> | <input type="checkbox"/> | <input type="checkbox"/> | <input type="checkbox"/> | <input type="checkbox"/> | <input type="checkbox"/> | <input type="checkbox"/> | <input type="checkbox"/> | <input type="checkbox"/> |
| <input type="checkbox"/> | <input type="checkbox"/> | <input type="checkbox"/> | <input type="checkbox"/> | <input type="checkbox"/> | <input type="checkbox"/> | <input type="checkbox"/> | <input type="checkbox"/> | <input type="checkbox"/> |
| <input type="checkbox"/> | <input type="checkbox"/> | <input type="checkbox"/> | <input type="checkbox"/> | <input type="checkbox"/> | <input type="checkbox"/> | <input type="checkbox"/> | <input type="checkbox"/> | <input type="checkbox"/> |
| <input type="checkbox"/> | <input type="checkbox"/> | <input type="checkbox"/> | <input type="checkbox"/> | <input type="checkbox"/> | <input type="checkbox"/> | <input type="checkbox"/> | <input type="checkbox"/> | <input type="checkbox"/> |
| <input type="checkbox"/> | <input type="checkbox"/> | <input type="checkbox"/> | <input type="checkbox"/> | <input type="checkbox"/> | <input type="checkbox"/> | <input type="checkbox"/> | <input type="checkbox"/> | <input type="checkbox"/> |
| <input type="checkbox"/> | <input type="checkbox"/> | <input type="checkbox"/> | <input type="checkbox"/> | <input type="checkbox"/> | <input type="checkbox"/> | <input type="checkbox"/> | <input type="checkbox"/> | <input type="checkbox"/> |
| <input type="checkbox"/> | <input type="checkbox"/> | <input type="checkbox"/> | <input type="checkbox"/> | <input type="checkbox"/> | <input type="checkbox"/> | <input type="checkbox"/> | <input type="checkbox"/> | <input type="checkbox"/> |
| <input type="checkbox"/> | <input type="checkbox"/> | | | | | | | |

Preset Sequence 1, Preset Sequence 2, Preset Sequence 3

The preset sequence can be set.

[Select all] buttons:Select all preset positions.

[Cancel all] buttons:You can release all selections.

1~256:Enables/disables the corresponding preset position.

[Set] buttons:Save the settings of the created preset sequence.



[Note:]

- When the preset sequence is activated, the registered preset positions are moved from a younger number to a higher order.
- After moving to the trailing preset position, the system returns to the youngest number and moves the preset position back in sequence.

10.2.3 Set auto pan (Auto pan setting screen)

In the [Position] tab of the PTZ-page to the Advanced Settings tab of [Auto pan]>>Click the [Button].

→[10.2 \[Position\] for setting positions](#)

Here, you can set auto pan.



[Note:]

- The items that can be set differ depending on the function of the model.
- Refer to the catalog specifications for the functions installed in each model.
- If the auto pan function is used for a long time, the drive parts may be consumed and the replacement cycle of consumables may be faster. For consumables, refer to the Web Guide.

Rapid PTZ Cameras, Multi-directional + PTZ(PTZ part)

10 Set PTZ

10.2 [Position] for setting positions

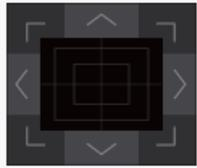
| Auto pan setting | | |
|-------------------------------------------------------------------------------------------------------------------------------------------------------------------------------------------------------------------------------------------------------|----------|------------------------------------------------------------------------------------|
| Position | | |
| Left end position setup | 315° | Set |
| Right end position setup | 45° | Set |
| Auto pan | | |
| Dwell time | 5s ▾ | |
| Speed | 13 °/s ▾ | |
| Endless panning | Off ▾ | |
| Set | | |
| Zoom | |  |
|    | | |
| Focus | | |
| Auto Near Far | | |
| Brightness | | |
|  Normal  | | |
| Preset | | |
| 1: ▾ | | Go |
| Close | | |

Indoor PTZ cameras

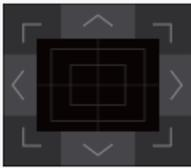
| | | |
|------------------------------------------------------------------------------------------------------------------------------|----------|------------------------------------------------------------------------------------|
| Auto pan setting | | |
| Position | | |
| Start position | 130° | Set |
| End position | 220° | Set |
| Auto pan | | |
| Dwell time | 5s ▾ | |
| Speed | 13 °/s ▾ | |
| Set | | |
| Zoom <input type="button" value="⊖"/> <input type="button" value="1"/> <input type="button" value="⊕"/> | |  |
| Focus <input type="button" value="Auto"/> <input type="button" value="Near"/> <input type="button" value="Far"/> | | |
| Brightness <input type="button" value="-"/> <input type="button" value="Normal"/> <input type="button" value="+"/> | | |
| Preset 1:Preset1 ▾ | | Go |
| Close | | |

Setting the end point

[Left end position setup]

Use the [Zoom], [Focus] and Control Pad/Buttons to move the camera to the desired position at the left end of the auto pan, and then press the [Set] button. Zoom and focus are set at the same time.



[Note:]

- The pan, tilt, and zoom operations are also available on the images in the [Position] tabs.

[Right end position setup]

Use the Control Pad/Button to move the camera to the desired position for the right end of the auto pan, and then press the [Set] button.

[Start position]

Use the [Zoom], [Focus] and Control Pad/Buttons to move the camera to the desired position at the left end of the auto pan, and then press the [Set] button. Zoom and focus are set at the same

time.



[Note:]

- The pan, tilt, and zoom operations are also available on the images in the [Position] tabs.

[End position]

Use the Control Pad/Button to move the camera to the desired position for the right end of the auto pan, and then press the [Set] button.

Auto pan operation

[Dwell time]

Select the stop time at the start and end positions from the following.

[0s]/ [1s]/ [2s]/ [3s]/ [4s]/ [5s]/ [10s]/ [15s]/ [20s]/ [25s]/ [30s]

[Speed]

Select the pivot speed of the pan operation from the following.

[1° /s], [2° /s], [3° /s], [4° /s], [5° /s], [7° /s], [10° /s], [13° /s], [18° /s], [24° /s]



[Important]

- If you set [Auto pan], be sure to press [Set].



[Note:]

- Even when the magnification of the digital zoom is set, the turn of the pan operation is performed at a position less than 34 times.

[Zoom], [Focus], Control Pad/Button, [Brightness], and Move presets buttons

Please refer to the following instructions for operation.

→[2.3.2 About live image pages](#)

[Close] buttons

Click this button to close the auto pan setting screen.

10.2.4 Set patrol (Patrol function setting screen)

In the [Position] tab of the PTZ-page to the Advanced Settings tab of [Patrol]>>Click the [Button]. Here, information about patrols is set.

→10.2 [Position] for setting positions

The patrol function stores the pan/tilt/zoom/focus and reproduces the stored operation.



[Note:]

•If the patrol function is used for a long time, the drive parts may be consumed and the replacement cycle of consumables may be faster. For consumables, refer to the Web Guide.

Patrol setting

[Number of patrol pattern]

Select the number of memories in the patrol. The amount of time that can be stored varies depending on the number of memories.

1:The operation for 2 minutes is stored in Patrol 1.

2:The operation for one minute is stored in Patrol 1 and Patrol 2.

4:The operation for 30 seconds is stored in Patrol 1, Patrol 2, Patrol 3, and Patrol 4.



[Note:]

- When the number of memories is changed, the stored patrol operation is deleted.

[Learn patrol pattern]

Select the patrol number (1 to 4) you want to set by clicking [▼] on the [Patrol No.]. The [*] mark to the right of the patrol No. indicates that the patrol operation has already been stored. With Patrol No selected, clicking [Learn] starts storing the camera operation. The characters of [LEARNING(**S)] are displayed during storage. **S is the remaining time that can be stored. When [Stop] is clicked, memory is stopped while the camera is in memory and reproducing is stopped while the camera is in reproduction. When the remaining time is 0 seconds (0S), the operation stops automatically.

With Patrol No selected, clicking the [Execute] button reproduces the stored operation of the camera.



[Note:]

- The camera operations to be stored are as follows.
 - Operation start position memory
 - Pan tilt zoom focus position
 - When operating the camera
 - Move Pan Tilt Zoom Focus/Preset Position
- The auto focus function does not operate during the patrol operation. At this time, when zoom in from the WIDE side as a characteristic of the zoom lens, the focus is blurred. To store the zoom operation, start from the TELE side to prevent the focus from shifting.

[Zoom], [Focus], Control Pad/Button, [Brightness], and Move presets buttons

Please refer to the following instructions for operation.

→ [2.3.2 About live image pages](#)

[Close] buttons

Click this button to close the Patrol Settings window.

10.2.5 Setting for direction/direction setting (direction/direction setting screen)

In the [Position] tab of the PTZ-page to the Advanced Settings tab of [Direction/Angle setting]>> Click the [Button]. Here, you can set the direction/direction setting. When this page is displayed,

it moves to the punch position set to north.

→10.2 [Position] for setting positions



[Note:]

- The items that can be set differ depending on the function of the model.
- Refer to the catalog specifications for the functions installed in each model.

Rapid PTZ Cameras, Multi-directional + PTZ(PTZ part)

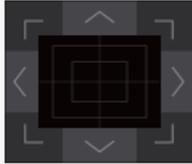
| | |
|------------------------------------------------------------------|------------------------------------------------------------------------------------------------------------------------------------------------------------|
| Direction/Angle setting | |
| North point setting | Set |
| Display character setting | |
| N | <input type="text" value="N"/> |
| NE | <input type="text" value="NE"/> |
| E | <input type="text" value="E"/> |
| SE | <input type="text" value="SE"/> |
| S | <input type="text" value="S"/> |
| SW | <input type="text" value="SW"/> |
| W | <input type="text" value="W"/> |
| NW | <input type="text" value="NW"/> |
| | Set |
| Panning 0° direction setting | Set Reset |
| Zoom | |
| <input type="button" value="⊖"/> | <input type="button" value="⊕"/> |
| Focus | |
| <input type="button" value="Auto"/> | <input type="button" value="Near"/> <input type="button" value="Far"/> |
| Brightness | |
| <input type="button" value="-"/> | <input type="button" value="Normal"/> <input type="button" value="+"/>  |
| Preset | Go |
| <input type="text" value="1:"/> <input type="button" value="v"/> | |
| Close | |

Indoor PTZ cameras

The screenshot displays a PTZ control interface with the following sections:

- Direction/Angle setting**: A header for the direction settings.
- North point setting**: A section with a "Set" button.
- Display character setting**: A section with eight input fields for directions: N, NE, E, SE, S, SW, W, and NW. Each field contains its corresponding direction label.
- Zoom**: Three buttons with minus, 1, and plus icons.
- Focus**: Three buttons labeled "Auto", "Near", and "Far".
- Brightness**: Three buttons labeled "-", "Normal", and "+".
- Preset**: A dropdown menu showing "1:Preset1" and a "Go" button.
- Close**: A large button at the bottom.

Direction/Angle setting

If the [Camera position display] on the [Cam. Function] tab of the PTZ page is set to [Direction display], the 8-directions are displayed in the preset position title display position.

[North point setting]

Set the orientation to be displayed as north (N) by adjusting the orientation of the pan and pressing [Set].

[Display character setting]

Individual names can be set for each direction/direction.

[N]:Set the north direction name.

[NE]:Set the name in the northeast direction.

[E]:Set the name in the east direction.

[SE]:Set the name in the southeast direction.

[S]:Set the name in the southern direction.

[SW]:Set the name in the southwest direction.

[W]:Set the name in the west direction.

[NW]:Set the name in the northwestern direction.

[Panning 0° direction setting]

Set the direction of the pan to 0°. If you adjust the field angle with the control pad/button and click the [Set] button, the direction of the pan you are presently pointing to will be 0°. Press [Reset] to return to the default settings.



[Note:]

- Tilts are not set in the 0° direction.
- Changing the 0° direction of the pan does not change the position of the preset position already set. The set auto pan turns within the same range as before the change. Similarly, the same operation as before the change is performed for the patrol setting.

[Zoom], [Focus], Control Pad/Button, [Brightness], and Move presets buttons

Please refer to the following instructions for operation.

→[2.3.2 About live image pages](#)

[Close] buttons

Click this button to close the direction/direction setting window.

10.2.6 Setting of pan/tilt range (pan/tilt range setting screen)

In the [Position] tab of the PTZ-page to the Advanced Settings tab of [Pan/tilt range setting]>>

Click the [Button].

→[10.2 \[Position\] for setting positions](#) Here, the range of pan tilt is set.

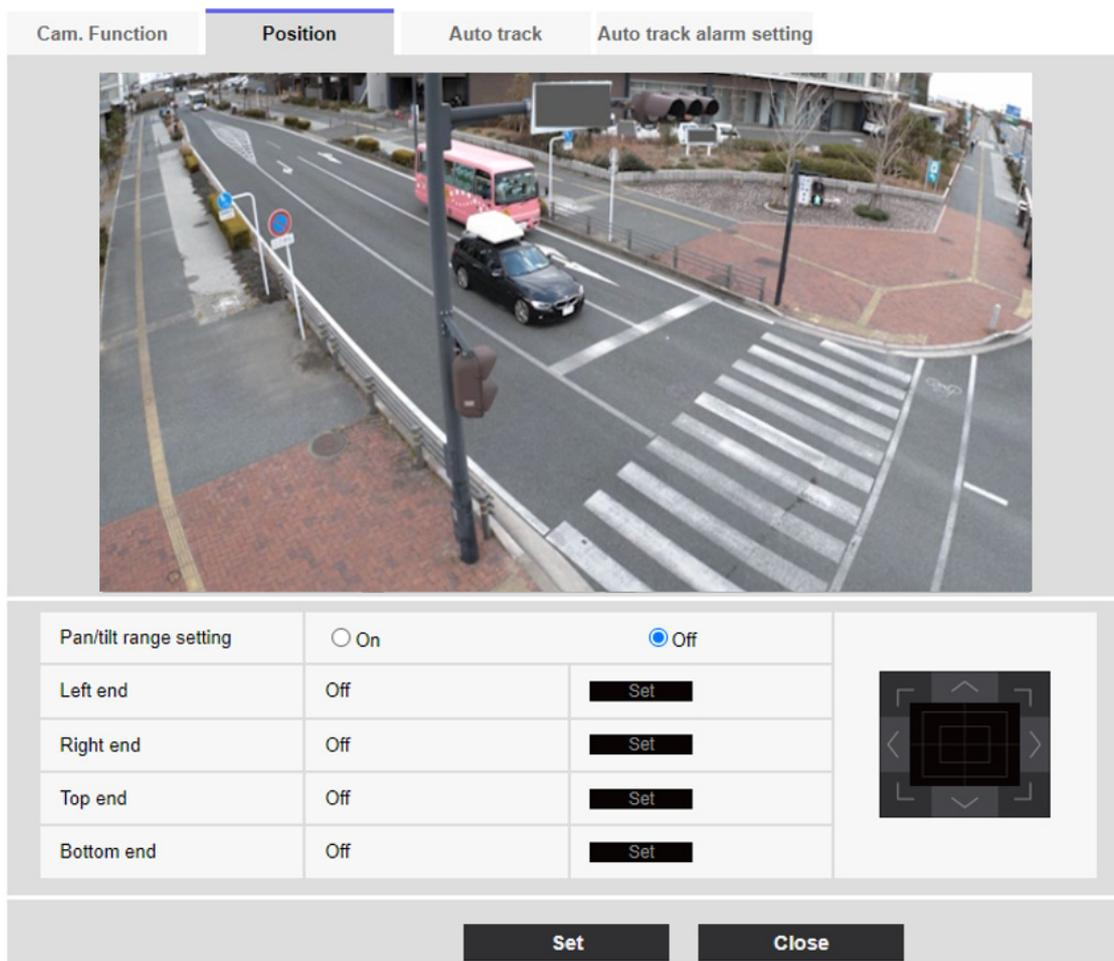

Pan/tilt range setting

On/Off sets whether to enable the range that restricts the pan tilt operation.

Set [On] and use the control pads/buttons to adjust the field angle to set [Left end], [Right end], [Top end] and [Bottom end].

[Left end]/[Right end]/[Top end]/[Bottom end]

Adjust the angle of view with the control pad/button and press the [Set] button to view the angle at the set position.



[Note:]

- The [Left end] angle should be smaller than the [Right end] angle and the [Bottom end] angle should be larger than the [Top end] angle.
- Set [Pan/tilt range setting] on a screen that is not zoomed in.

If you set the display size to 1.0 times (x1) on the zoomed display, a larger area than when the display was set (enlarged display) is displayed.

- Incorrect settings may cause you to view unexpected camera images. After setting, be sure to check the image using the pan tilt operation.
- Configure [Pan/tilt range setting] prior to setting the preset position. If the preset position is outside the range of [Pan/tilt range setting], the preset position stops at the end of the range.
- When the pantilt range setting screen is displayed, the zoom factor is 1.0 times. During [Pan/tilt range setting], [PT LIMIT SETTING] is displayed in the images.
 - If you do not operate for 5 minutes, the [Pan/tilt range setting] [Set] will be disabled. To continue the operation, display the [Pan/tilt range setting] window again and set it.

10.3 Set auto-tracking (Auto-tracking screen)

Click on the [Auto track setting] tab of the PTZ page.

Here, you can register, change, or delete auto tracking settings.



[Note:]

- Auto track setup is not available under the following conditions.
 - When [16:9 mode(60fps mode)], [16:9 mode(50fps mode)], [4:3 mode(15fps mode)] or [4:3 mode(12.5fps mode)] is selected for [Image capture mode]
- Under the following conditions, auto track setup is available, but the auto track performance will lower.
 - When [Maximum shutter] of [Image adjust] - [Light control mode] is set to [Max.2/30s], [Max.4/30s], [Max.6/30s], [Max.10/30s], or [Max. 16/30s]. (For auto track, the [Max.1/30s] setting is recommended.)
- If the automatic tracking function is used for a long time, the drive parts may be consumed and the replacement cycle of consumables may be faster. For consumables, refer to the Web Guide.

Automatic tracking is a function that automatically tracks and shoots an object when it is detected in a predetermined auto pan, preset sequence/preset position, patrol, or area.

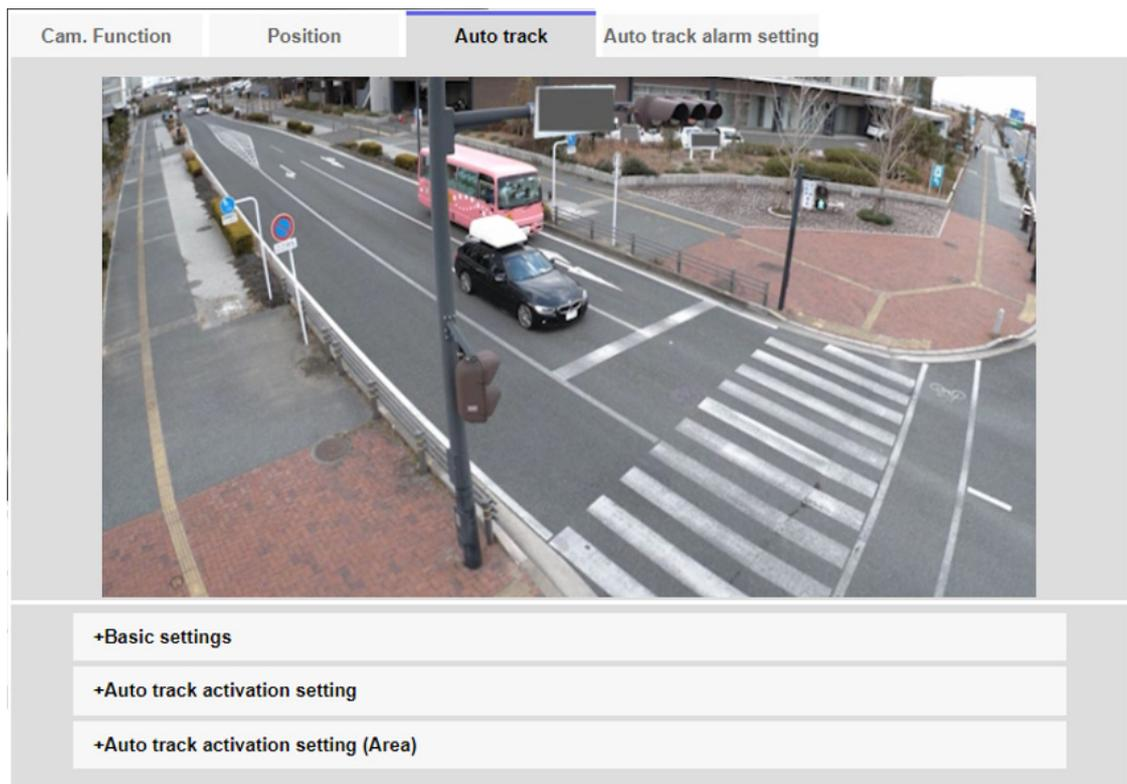

Basic settings

[Detection object]

The object to be detected can be selected. You can select multiple objects.

[Human]:Automatic tracking is performed when a person is detected.

[Vehicle]:Automatic tracking is performed when a car is detected.

[Bicycle]:Automatic tracking is performed when a motorcycle is detected.

[Object size]

Select the size at tracking from the following.

[Small (1/4 of the image)]:Zoom the tracking object to the monitor screen up to about 1/4 (vertical) size.

[Medium (1/2 of the image)]:Zoom the tracking object to the monitor screen up to about 1/2 (vertical) size.

[Large (3/4 of the image)]:Zoom the tracking object to the monitor screen up to approximately 3/4 (vertical) size.

[No size adjustment]:Zoom control is not performed during tracking.



[Note:]

- The size is only a guide. Depending on the environmental conditions and tracking conditions, the assumed size may not be achieved.
- Increasing the size of the object to be tracked reduces the tracking performance.

[Sensitivity]

Select the sensitivity during tracking from the following.

[High]/[Middle]/[Low]



[Note:]

- The lower the sensitivity, the less false detection due to wooden shaking, but the lower the tracking performance. On the other hand, higher sensitivity improves tracking performance, but it also increases false detection. Set according to the environment.

[Longest tracking time]

Select the time from below from the start of auto-tracking to forced termination.

[Off(Unlimited)]/[10s]/[20s]/[30s]/[40s]/[50s]/[1min]/[2min]/[3min]/[5min]/[10min]



[Note:]

- After the maximum tracking time, the camera stops in that position. When the auto mode operation is restored, the self-return time is counted and the auto mode operation is restored after the tracking is stopped by setting the self-return.

[Auto track data in video stream]

Select whether to send the superimposed image data by adding auto-tracking information to the image.

[Off]: Automatic tracking information is not added to the image.

[On]: This feature adds automatic tracking information to images, but does not display target frames for objects under automatic tracking in live pictures.

[On (with track video display)]: This feature adds auto-tracking information to images and displays the target frame for objects under auto-tracking in live pictures.

Auto tracking start setting

[Auto pan]

Select whether or not to automatically track the user during auto panning.

[Enable]: Automatic tracking is started during auto panning.

[Disable]: Automatic tracking is not started during auto pan.

[Preset sequence/Preset position]

Choose whether to auto track in preset sequence or in preset position.

[Enable]:Automatic tracking is started during the preset sequence or in the preset position.

[Disable]:Automatic tracking is not started during preset sequence or preset position.

[Preset position selection]

[Select all] buttons:Select all preset positions.

[Cancel all] buttons:You can release all selections.

1~256:Toggle the corresponding preset position [On] or [Off].

[Set] buttons:Save the settings of the created preset sequence.

[Patrol]

Select whether or not to automatically track when a tracking target is detected during patrol.

[Enable]:Start automatic tracking during patrol.

[Disable]:Automatic tracking is not started during patrol.

Auto Track Activation Setting (Area)

[Area select]

When [Detection object] appears in the specified area, auto tracking can be started.

Eight areas can be set.

[Set] buttons:Set the auto tracking start area to the specified area No.

[Delete] buttons:Deletes the auto tracking area set to the specified area number.

[Cancel] buttons:Cancels the setting of the currently set auto tracking area.

[Zoom], [Focus], Control Pad/Button, [Brightness], and Move presets buttons

Please refer to the following instructions for operation.

→[2.3.2 About live image pages](#)

[Close] buttons

Click this button to close the Auto Tracking Settings window.



[Important]

- In the following cases, the target subject may not be tracked or may malfunction.
 - Low contrast between the subject and the background
 - If the dome is moist or dirty
 - Large variation in illumination
 - When there are many movements other than the subject

When the subject moves directly below the camera

If flickering is severe

-reflection of light through windows, reflection of road surfaces, reflection of backlight into the dome, etc.

When a tracking object is hidden in the pole or behind the object.

-when multiple subjects intersect or crowd

When the subject moves too fast or too slowly

-if the subject is too small or too large

If the camera is swaying

If the weather is very bad

-when the image correction function is ON

- It is recommended to use the product in the following installation environment to increase the detection accuracy.
 - more than about 1/5 (vertical) of the size of the monitor screen
- We shall not be liable for any inconvenience, damage, or damage caused by the automatic tracking function settings or the results.

Procedure for setting automatic tracking linkage

When two or more cameras with automatic tracking function are used, the tracking of objects can be coordinated between the cameras.

(Automatic Tracking Coordination Function)

As an example, as shown in the figure below, the procedure for setting the connection from Camera 1 (IP address: 192.168.0.11) to Camera 2 (IP address: 192.168.0.12) when the tracking target enters the alarm area No.1.

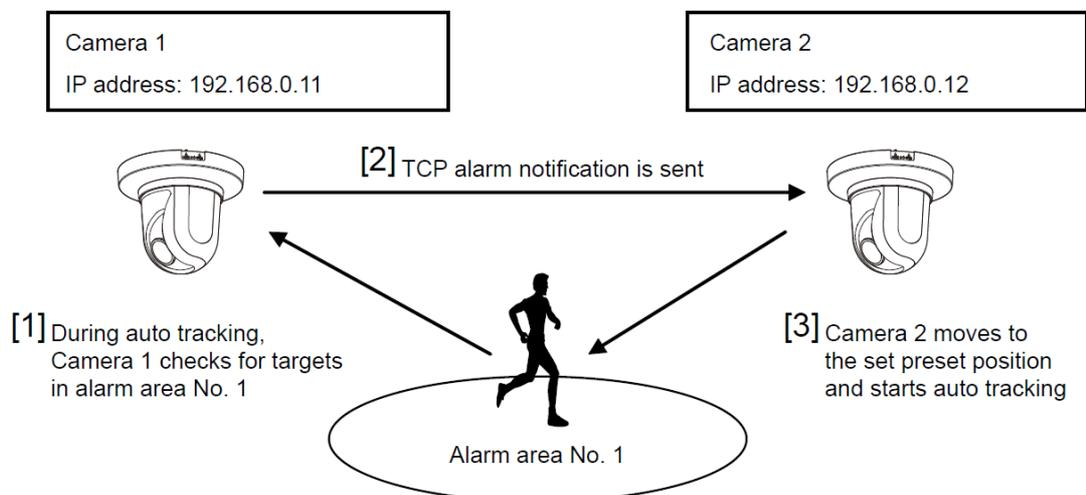

- 1 Set the alarm area for the area for which automatic tracking is desired in Camera 1.
 - ① The auto tracking setting screen is displayed.
 - ② Select [On(In preset alarm area)] in [Auto track alarm] and press [Set].
 - ③ In the Alarm area [Area select], select 1 from the [Area No.] pull-down.
 - ④ While looking at the screen, perform pan tilt zoom to set the alarm area.
 - ⑤ Press [Set].
 - 2 Set the preset position to move when receiving the unique notification command in camera 2.
(Set the preset position so that the alarm area No.1 of Camera 1 set in step 1 enters the screen.)
 - ① The preset position setting screen is displayed.
→[10.2.1 Set the preset position \(preset position setting screen\)](#)
 - ② Select the desired number from the [Preset] pull-down list.
 - ③ While viewing the screen, set the preset position by using the pan tilt zoom.
 - ④ Press [Register].
 - 3 Set Camera 1 (IP address: 192.168.0.11) to notify the command.
 - ① The Alarm Page [Notification] window is displayed.
→[12.12 \[Notification\] to set alarm notification](#)
 - ② Set [TCP alarm notification] to [On] and press [Set].
 - ③ In the [Destination of notification] [Notify Destination 1] (which may be selected), check the [Alarm] checkbox and insert 192.168.0.12 in the [Destination address].
 - ④ Set [Auto track cooperation] to [On] and select Alarm area No. 1.
 - ⑤ Press [Set].
 - 4 Set Camera 2 (IP address: 192.168.0.12) to receive the command.
 - ① The Alarm Page [Alarm] window is displayed.
→[12.1 \[Alarm\] to set alarm operation](#)
 - ② Set the [Alarm] [Command alarm] to [On] and press [Set].
 - ③ Set the [Camera action on alarm] [Command alarm] to [Preset per sender] and press [Preset per sender].
 - ④ On the Preset by Source window, check Auto Tracking of [Source Address 1] (any Source Address may be selected), enter the Source Address 192.168.0.11 (Camera 1), select the preset position to move when receiving the command set in step 2, click [Set], and close the pages.
→[12.4.1 Set the preset position by source \(screen for setting preset position by source\)](#)
 - ⑤ Press [Set].
 - 5 By starting the automatic tracking operation of camera 1, the automatic tracking linkage function can be used.
-

10.4 Set Auto Track Alarm (Auto Track Alarm screen)

Click on the [Auto track alarm setting] tab of the PTZ page. Here, you can set the automatic tracking alarm.



[Note:]

- Automatic tracking is not available in the following cases.
 - When [Image capture mode] is [16:9 (60 fps mode)], [16:9 (50 fps mode)], [4:3 (15 fps mode)], [4:3 (12.5 fps mode)]
 - When the [Light control mode] [Maximum shutter] of [Image adjust] is set to the following
Maximum 2/30s/Maximum 4/30s/Maximum 6/30s/Maximum 10/30s/Maximum 16/30s
- If the automatic tracking function is used for a long time, the drive parts may be consumed and the replacement cycle of consumables may be faster. For consumables, refer to the Web Guide.

The auto tracking function automatically tracks and shoots the subject when movement is detected in the pre-set alarm area.

Cam. Function
Position
Auto track
Auto track alarm setting



| | |
|------------------|--------------------------------------|
| Auto track alarm | Off <input type="button" value="v"/> |
| Alarm wait time | 10s <input type="button" value="v"/> |

| | |
|-----------------------|-------------------------------------------------|
| Alarm area | |
| Area select | Area No. <input type="button" value="v"/> |
| Area No. notification | TCP alarm notification >> |

* When notifying alarm area numbers by the TCP alarm notification, set "Additional alarm data" to "On".

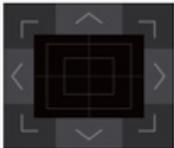
| | | |
|----------------------------------------------------------------------------------------------------------------------------|-------------------------------------------------------------------------------------|------------------------------------------------------------------------------------------------------------------------------|
| Zoom <input type="button" value="⊖"/> <input type="button" value="⊕"/> |  | Brightness <input type="button" value="-"/> <input type="button" value="Normal"/> <input type="button" value="+"/> |
| Focus <input type="button" value="Auto"/> <input type="button" value="Near"/> <input type="button" value="Far"/> | | Preset 1: <input type="button" value="v"/> |

[Auto track alarm]

Select the alarm during automatic tracking from the following.

[Off]: Alarm is not output.

[On (Immediate)]: During automatic tracking, the alarm will continue to be output. The output interval is every 5 seconds.

[On (After alarm wait time)]: The alarm is output only once when automatic tracking continues for a certain period of time.

[On (In preset alarm area)]: During automatic tracking, the alarm is output only once when a

tracking object is in the set alarm area. Refer to [Alarm area] for the alarm settings.

[Alarm wait time]

If [Auto track alarm] is set to [On(After alarm wait time)], select the set time from the following.

[1s]/ [10s]/ [30s]/ [1min]/ [3min]/ [5min]

Alarm area

[Area select]

Click [▼] on the [Area No.] and select the area number (1 to 8) to be set. The [*] mark to the right of the area No. indicates that the area is already stored. The alarm area is enabled when On (when the alarm area enters) is selected for automatic tracking alarm.

[Area No. notification]

Clicking [TCP alarm notification setup] displays the [Notification] tabs on the Alarm Page.

→[12.12 \[Notification\] to set alarm notification](#)



[Note:]

- The alarm area cannot be set individually for each preset position. The configured area is valid for all preset positions.

11 Configure the multi-screen settings[Multi-screen]

The cameras from which images are to be displayed on a multi-screen can be registered on the [Multi-screen] page.

→5.1 [How to display](#)

→5.2 [How to operate](#)



[Note:]

•[New X Fixed-8MP][New X Fixed-6MP][New X Fixed-5MP]If [Image capture mode] is set to [60fps Mode] or [50fps Mode], [Multi-screen] cannot be used.

[IP address]

Enter the IP address or the host name of the camera to be used for the multi-screen. 4 cameras can be registered as a group and up to 4 groups (16 cameras) can be registered.

When the HTTP port number for the camera of which images are to be displayed had been changed, enter as follows:

Example of entry:

Example when entering an IPv4 address: http://192.168.0.10:8080

Example when entering an IPv6 address: http://[2001:db8:0:0:0:0:1]:8080

To access the cameras using the HTTPS protocol, enter as follows:

Example of entry: https://192.168.0.10/

Available number of characters: 1 - 128 characters



[Important]

•When accessing the camera using the HTTPS protocol, it is necessary to install the pre-installed certificate or the CA certificate of the camera to display images on the monitor. For how to install, refer to video clips <Control No.: P0002> and <Control No.: P0003> on the support video page on our support website.

•This camera is specified when “selfcamera” is displayed for the IP address or host name.



[Note:]

- When using the host name, it is necessary to configure the DNS settings of the PC to be used for the multi-screen display. Refer to the network administrator for information on the DNS setting of PCs.

[Camera title]

Enter the title of the camera. The entered camera title will be displayed on a multi-screen.

Available number of characters: 0 - 20 characters

Unavailable characters: " &



[Note:]

- When selecting a 16 split-screen, some characters of the camera title to be displayed may not be displayed.
- Even when [16:9] is selected for the aspect ratio, the multi-screen is displayed in 4:3.

Initial display

[Layout]

Select the layout for the initial display from the following:

4 Screens(1-4)/ 4 Screens(5-8)/ 4 Screens(9-12)/ 4 Screens(13-16)/ 9 Screens(1-9)/ 9 Screens(10-16)/ 16 Screens

[Refresh interval]

MJPEG: Displays the camera image in the motion JPEG format (video).

Refresh interval : 1s/ Refresh interval : 3s/ Refresh interval : 5s/ Refresh interval : 10s/ Refresh interval : 30s/ Refresh interval : 60s: Displays the JPEG format (still image) camera image in the selected interval.

[Image capture size(4 Screens)]

Select the image capture size for 4 screens in initial display.

640x360/320x180

12 [Alarm] to set the alarm

The alarm page is used to set the alarm operation using the external I/O terminal of the camera, the alarm image, the area to detect the alarm, and the alarm notification. The Alarm page consists of the [Alarm], [VMD area], [SCD area], [Audio detection], [Impact detection], [Casing open detection], and [Notification] tabs.



[Note:]

- The items that can be set differ depending on the function of the model.
- Refer to the catalog specifications for the functions installed in each model.

12.1 [Alarm] to set alarm operation

Click [Alarm] on the Alarm page. Refer to the following how to display and operate the Advanced menu.

→5.1 [How to display](#)

→5.2 [How to operate](#)

This is used to set the operation when an alarm is detected. For the alarm image and output terminal settings, refer to the following.

→12.4 [\[Alarm\] to set alarm linkage operation](#)

→12.2 [\[Alarm\] for setting the output terminal](#)

Alarm

[Terminal 1]

Set the operation of terminal 1.

[Off]:Not used

[Alarm input (TRM1)]:The alarm input is received. When Alarm is selected, a pull-down menu ([Close], [Open], [Close(Continue)], [Open(Continue)]) is displayed.

-[Close]:When the terminal status changes to [Close], an alarm is detected.

-[Open]:When the terminal status changes to [Open], an alarm is detected.

-[Close (Continue)]:When the terminal status changes to [Close], an alarm is detected. When the terminal status is [Close], the alarm is detected periodically at intervals of no alarm detection time.

-**[Open (continue)]**:When the terminal status changes to [Open], an alarm is detected. When the terminal status is [Open], the alarm is detected periodically at intervals of no alarm detection time.

[Black and white switching input]:The black-and-white selector input is received. (When the input is [On], the input is switched to black and white)

[Automatic Time Adjustment]:Time setting by terminal input is accepted. When the signal is input, set to 00 minutes 00 seconds if the time difference from the normal time (00 minutes per hour) is 29 minutes or less. In the case of returning the time less than 5 seconds during SD recording, the time is not changed. Selecting Auto Time Adjustment displays the pull-down menu for short circuit and release selection.

-**[Close]**:When the terminal status changes to [Close], the time is automatically adjusted.

-**[Open]**:When the terminal status changes to [Open], the time is automatically adjusted.

[Terminal 2]

Set the operation of terminal 2.

[Off]:Not used

[Alarm input (TRM2)]:The alarm input is received. When Alarm is selected, a pull-down menu ([Close], [Open], [Close(Continue)], [Open(Continue)]) is displayed.

-**[Close]**:When the terminal status changes to [Close], an alarm is detected.

-**[Open]**:When the terminal status changes to [Open], an alarm is detected.

-**[Close (Continued)]**:When the terminal status changes to [Close], an alarm is detected. When the terminal status is [Close], the alarm is detected periodically at intervals of no alarm detection time.

-**[Open (continued)]**:When the terminal status changes to [Open], an alarm is detected. When the terminal status is [Open], the alarm is detected periodically at intervals of no alarm detection time.

[Alarm Output]:Alarm outputs according to the setting in [Output terminal].

→[12.2 \[Alarm\] for setting the output terminal](#)

[Terminal 3]

Set the operation of terminal 3.

[Off]:Not used

[Alarm input (TRM3)]:The alarm input is received. When Alarm is selected, a pull-down menu ([Close], [Open], [Close(Continue)], [Open(Continue)]) is displayed.

-**[Close]**:When the terminal status changes to [Close], an alarm is detected.

-**[Open]**:When the terminal status changes to [Open], an alarm is detected.

-**[Close (Continued)]**:When the terminal status changes to [Close], an alarm is detected. When the terminal status is [Close], the alarm is detected periodically at intervals of no alarm detection

time.

-**[Open (continued)]**:When the terminal status changes to [Open], an alarm is detected. When the terminal status is [Open], the alarm is detected periodically at intervals of no alarm detection time.

[Aux output]:AUX output is performed. The [AUX] buttons appear on the live picture pages.



[Important]

- It takes approximately 100 ms or longer to detect an alarm input to a short circuit (ON) or an alarm input to an open circuit (OFF) of the external I/O terminal. The alarm input will not be detected until the time set by [Alarm deactivation time] has elapsed.



[Note:]

- AUX is a camera terminal that can be operated (opened/closed) by the operator from the live image page. For example, when you want to operate lighting in the location where the camera is installed, you can operate it remotely by connecting it to a lighting control device.
- For the input/output ratings of each terminal, refer to the installation manual of the model.

[VMD alarm]

Clicking [VMD] displays the [VMD area] tabs on the Alarm Page.

→[12.6 \[VMD area\] to set the motion detection area](#)

[Scene change detection (SCD) alarm]

Clicking [SCD] displays the [SCD area] tabs on the Alarm Page.

→[12.8 \[SCD area\] to set up undesired detection areas](#)

[Auto track alarm]

Clicking [Auto track setting] displays the [Auto track alarm setting] tabs for the PTZ pages.

→[10.4 Set Auto Track Alarm \(Auto Track Alarm screen\)](#)

[Audio detection alarm]

Clicking [Audio detection] displays the [Audio detection] tabs on the Alarm Page.

→[12.9 \[Audio detection\] for setting sound detection](#)

[Impact detection alarm]

Clicking [Impact detection] displays the [Impact detection] tabs on the Alarm Page.

→[12.10 \[Impact detection\] for setting impact detection](#)

[Casing open detection alarm]

Clicking [Casing open detection] displays the [Casing open detection] tabs on the Alarm Page.

→12.11 [Casing open detection] for setting opening detection

[Command alarm]

Use [On] or [Off] to specify whether or not to accept the command alarm.

Command alarm is a function to receive unique alarm notification from other cameras. When set to [On], the alarms can be operated in conjunction with several cameras.

[Reception port]

Set the port number to which the command alarm is received.

Settable range:1~65535

The following port numbers cannot be set because they are used by this computer.

20、21、22、23、25、42、53、67、68、69、80、110、123、161、162、443、554、995、1883、8883、10669、10670、59000~61000

[Alarm deactivation time]

Sets the time when the alarm is detected and the detection operation is not executed. For example, this setting prevents sending too much mail to a mobile terminal or a tablet terminal when it is set to send mail notification by an alarm.

0.5s、1 ~ 600s



[Note:]

- Alarm detection time is managed for each alarm type. For example, the operation detection alarm and disturbance detection alarm are detected even during the no alarm detection time of the command alarm.
- [MULTI] The port numbers 32768 to 49151 cannot be set.

[Alarm test]

Clicking [Execute] performs the alarm test function.



[Note:]

- When the alarm test function is executed, the computer detects the command alarm.

This function can be used to record an SD Memory Card triggered by alarm detection or to confirm notification to an external device. Use the external device specified as the notification destination and the system log of this equipment to check the related settings.

- The alarm test function cannot be generated more than once within the alarm detection time.

12.2 [Alarm] for setting the output terminal

Click [Alarm] on the Alarm page. Refer to the following how to display and operate the Advanced menu.

→5.1 [How to display](#)

→5.2 [How to operate](#)

Here, the output terminal is set.

Output terminal

For the output terminal function, the [Terminal 2] of the [Alarm] setting must be set to [Alarm output].

[Terminal output upon alarm detection]

Sets on/off whether an alarm signal is output to the output terminal when an alarm is detected.

[SD memory card error]

The [On] or [Off] is used to determine whether to output signals to the output terminals when an SD memory card alarm is detected.

SD Memory Card Alarm Detection Conditions: SD Memory Card error (write error, read error, etc.), Operating time: 6 years, Overwrite count: 2,000 times

[On]:When the alarm condition is detected, a signal is output to the output terminal and [Alarm notification] of the live picture is popped up.

[Off]:Stops detecting the alarm condition.



[Important]

- To use this function correctly, format the SD Memory Card on your computer before using the SD Memory Card.



[Note:]

- Operation time: For 6 years, the power-on time after the SD card is inserted into the camera, and for 2000 times, the upper limit of the number of business SD Memory Card (MLC type) rewrites is used as a guide, and this does not guarantee a durability period.
- The output terminal and SD Memory Card Alarm use the same output terminal.
- When either an alarm or SD Memory Card alarm is activated, a signal is output to

the output terminal.

- When an SD Memory Card Alarm is detected, the [Alarm Notice] on the live image page is popped out. Click the [x] button of [Alarm notification] to clear the [Alarm notification] display.
- The output signal output by the SD Memory Card alarm depends on the alarm format setting.

In the case of latches: The output signal continues for the duration of the cause of the SD Memory Card warning even after the alarm notification is cleared.

For pulses: The signal output of the output terminal continues while the cause of the SD Memory Card warning persists even after the alarm notification is cleared.

However, when the time set in [Alarm output time] has elapsed, the signal output of the output terminal stops.

[Terminal state upon alarm detection]

Set the output terminal operation when an alarm is detected to either [Latch] or [Pulse].

[Latch]: When an alarm is detected, the alarm output terminal is set to [Terminal action upon alarm detection] until [x] is clicked in [Alarm notification].

[Pulse]: When an alarm is detected, the terminal at the time of alarm outputting is set by [Terminal action upon alarm detection] for the period set by [Pulse output width]. Click the [x] button of [Alarm notification] to return the output terminal to the normal state.

[Terminal action upon alarm detection]

Set the output status of the alarm output from the output terminal by [Open] or [Close].

[Open]: Set the alarm output terminal to Open (usually Close).

[Close]: The terminal at the time of alarm output is closed (normally open).



[Note:]

- When set to [Open], the alarm will be output for approximately 20 seconds when the power to the computer is turned on.

[Pulse output width]

Sets the time when the alarm is output from the output terminal when [Pulse] is selected in [Terminal state upon alarm detection].

Settable range: 1 ~ 120s

12.3 [Alarm] to change the aux name

Click [Alarm] on the Alarm page. (See the following for how to display and operate the Advanced menu.

→5.1 [How to display](#)

→5.2 [How to operate](#)

You can change the [AUX], [Open], and [Close] names for live picture pages.

AUX title

[AUX (Up to 10 characters)]

Enter the [AUX] name for the live picture page.

Characters that cannot be entered:Half-pitch symbol " &

[Open (Up to 5 characters)]

Enter the [Open] name for the [AUX] buttons on the live picture pages.

Characters that cannot be entered:Half-pitch symbol " &

[Close (Up to 5 characters)]

Enter the [Close] name for the [AUX] buttons on the live picture pages.

Characters that cannot be entered:Half-pitch symbol " &



[Note:]

- The AUX name can be changed when [Terminal 3] in the [Alarm] setting is set to [AUX output].
- AUX is a camera terminal that can be operated (Open/Close) by the operator from the live picture page. For example, when you want to operate lighting in the location where the camera is installed, you can operate it remotely by connecting it to a lighting control device.

12.4 [Alarm] to set alarm linkage operation

Click [Alarm] on the Alarm page. Refer to the following how to display and operate the Advanced menu.

→5.1 [How to display](#)

→5.2 How to operate

This section sets the function to operate in conjunction with the alarm.



[Note:]

- Refer to the catalog specifications for the functions installed in each model.
- [PTZ] [Terminal alarm 1], [Terminal alarm 2], [Terminal alarm 3], [VMD alarm], [Scene change detection (SCD) alarm], [Audio detection alarm], and [Command alarm] can only be set for PTZ cameras.

[Terminal alarm 1]Select the action to be interlocked when terminal alarm 1 is detected from the following. This can be set when [Terminal 1] of the alarm is set to [Alarm input(TRM1)].

[Off]:Interlock operation is not performed even if terminal alarm 1 is detected.

1~256:When the preset position registered in advance is selected, the watch moves to the preset position when terminal alarm 1 is detected.

[Patrol 1]:When terminal alarm 1 is detected, patrol starts. *When Patrol 1 is not registered, it is not displayed.

[Terminal alarm 2]

Select the action to be interlocked when terminal alarm 2 is detected from the following. This can be set when [Terminal 2] of the alarm is set to [Alarm input(TRM2)].

[Off]:Interlock operation is not performed even if terminal alarm 2 is detected.

1~256:When the preset position registered in advance is selected, it moves to the position when terminal alarm 2 is detected.

[Patrol 2]:When terminal alarm 2 is detected, patrol starts. *When Patrol 2 is not registered, it is not displayed.

[Terminal alarm 3]

Select the action to interlock when terminal alarm 3 is detected from the following. This can be set when [Terminal 3] of the alarm is set to [Alarm input(TRM3)].

[Off]:Interlock operation is not performed even if terminal alarm 3 is detected.

1~256:Select the preset position registered beforehand to move to the position when terminal alarm 3 is detected.

[Patrol 3]:When terminal alarm 3 is detected, patrol starts. *When Patrol 3 is not registered, it is not displayed.

[VMD alarm]

Select the action to be linked to the alarm detected by the motion detector from the following.

[Off]:When an alarm is detected by the motion detector, interlock operation is not performed.

12 [Alarm] to set the alarm

12.4 [Alarm] to set alarm linkage operation

1~256:Selecting the preset position registered beforehand moves the watch to the position when an alarm is detected by the motion detector.

[Patrol 1]:When an alarm is detected by the motion detector, a patrol is started. *When Patrol 1 is not registered, it is not displayed.

[Scene change detection (SCD) alarm]

Select the action to be interlocked when an alarm is detected by the undesired signal detection from the following.

[Off]:Interlock operation is not performed even if an alarm is detected by undesired signal detection.

1~256:When the preset position registered in advance is selected, the watch moves to the preset position when an alarm due to disturbance detection is detected.

[Patrol 1]:When an alarm is detected by the disturbance detection, a patrol is started. *When Patrol 1 is not registered, it is not displayed.

[Audio detection alarm]

Select the action to be linked to the alarm detected by the sound detection from the following.

[Off]:The product does not perform interlocked operation even if an alarm is detected by sound detection.

1~256:When the preset position registered in advance is selected, the watch moves to the preset position when an alarm is detected.

[Patrol 1]:When an alarm is detected by sound detection, patrol is started. *When Patrol 1 is not registered, it is not displayed.

[Command alarm]

Select the action to be linked to the alarm by the command alarm from the following. This can be set when [Command alarm] is set to [On].

[Off]:The product does not operate in conjunction with the command alarm.

1~256:Selecting the preset position registered in advance moves the camera to the position when a command alarm is detected.

[Patrol 1]:When a command alarm is detected, a patrol is started. *When Patrol 1 is not registered, it is not displayed.

Source-specific preset position:Register the address of the sender of the command alarm and the preset position corresponding to that address, and move to that position when the alarm is detected by the command alarm.

When [Preset per sender] is clicked, a separate window opens showing the settings for the source-specific preset position.

→[12.4.1 Set the preset position by source \(screen for setting preset position by source\)](#)

Command Alarm Action-Source Address

The IP address of the PTZ camera for the Multi-directional/PTZ integrated camera is displayed.

Operation at Command Alarm Interlocked operation

Select the action linked to the command alarm when received from the following.

[Off]: Interlock operation is not performed even if a command alarm is received.

[Alarm interlock]: Alarm operation is performed after the command alarm is received.

[Switching between black and white]: Switches between black and white after receiving the command alarm.

[Automatic Time Adjustment]: Adjusts the time after the command alarm is received.



[Note:]

- [MULTI_PTZ] Only Multi-directional cameras with integrated Multi-directional/PTZ cameras can be set to [Action at the time of a command alarm].

[Alarm E-mail notification]

When [E-mail notification setup] is clicked, the setting window for the e-mail when the alarm is generated is displayed in a separate window.

→ [12.4.2 Mail sending when an alarm is generated](#)

[Alarm image FTP/SFTP transmission]

When [FTP/SFTP setup] is clicked, a separate window is displayed for FTP/SFTP sending when an alarm is generated.

→ [12.4.3 Set up FTP/SFTP transmission when an alarm is generated](#)

[Alarm image recording(SD memory card)]

When [SD memory card setup] is clicked, the settings for recording to the SD Memory Card when an alarm is generated are displayed in a separate window.

→ [12.4.4 Sets recording data to SD Memory Card when alarm is generated.](#)

[TCP alarm notification]

When [TCP alarm notification setup] is clicked, the setting window for sending unique alarm notification when alarm is generated is displayed in a separate window.

→ [12.4.5 Sets unique alarm notification when an alarm is generated.](#)

[HTTP alarm notification]

When [HTTP alarm notification setup] is clicked, the setting window for sending HTTP alarm notification when alarm is generated is displayed in a separate window.

→ [12.4.6 Sets HTTP alarm notification when an alarm is generated.](#)

[SNMP transmission upon alarm detection]

When [To SNMP setting] is clicked, the setting window for sending SNMP when an alarm is generated is displayed in a separate window.

→ [12.4.7 Set SNMP transmission when an alarm is generated.](#)

12 [Alarm] to set the alarm

12.4 [Alarm] to set alarm linkage operation

12.4.1 Set the preset position by source (screen for setting preset position by source)

On the [Alarm] tab of the Alarm page, press [Preset per sender >>] in [Command alarm].

→12.1 [Alarm] to set alarm operation

Here, the address of the source of the command alarm and the preset position corresponding to that address are registered.

| Preset per sender | | | | | | |
|--------------------|----------------------|-----|---------------------------------------------------------------|-------------------------|----------------|------------------------------------|
| Sender's address 1 | <input type="text"/> | Off | <input type="radio"/> On <input checked="" type="radio"/> Off | Notification per Camera | Alarm area No. | Reception setting during live view |
| Sender's address 2 | <input type="text"/> | Off | <input type="radio"/> On <input checked="" type="radio"/> Off | Notification per Camera | Alarm area No. | Reception setting during live view |
| Sender's address 3 | <input type="text"/> | Off | <input type="radio"/> On <input checked="" type="radio"/> Off | Notification per Camera | Alarm area No. | Reception setting during live view |
| Sender's address 4 | <input type="text"/> | Off | <input type="radio"/> On <input checked="" type="radio"/> Off | Notification per Camera | Alarm area No. | Reception setting during live view |
| Sender's address 5 | <input type="text"/> | Off | <input type="radio"/> On <input checked="" type="radio"/> Off | Notification per Camera | Alarm area No. | Reception setting during live view |
| Sender's address 6 | <input type="text"/> | Off | <input type="radio"/> On <input checked="" type="radio"/> Off | Notification per Camera | Alarm area No. | Reception setting during live view |
| Sender's address 7 | <input type="text"/> | Off | <input type="radio"/> On <input checked="" type="radio"/> Off | Notification per Camera | Alarm area No. | Reception setting during live view |

Set **Close**

[Sender's address 1] through [Sender's address 48]

Set the IP address of the sender of the command alarm and the preset position to move corresponding to the IP address. You can set up to 48 notifications.

[Notification per Camera]

If the transmission source is a Multi-directional camera, select the camera number of the transmission source. Otherwise, select [1].

[On]/[Off] (Alarm area no. interlock)

Use [On]/[Off] to set whether or not to link with [Alarm area No.].

[Alarm area No.]

- 12 [Alarm] to set the alarm
 - 12.4 [Alarm] to set alarm linkage operation
-

When [Alarm Area No. Interlock] is set, select the sender alarm area No. from 1 to 8.

[On]/[Off] (Reception setting during live view)

On/Off is used to select whether to link with the clicking operation of the live image of the Multi-directional camera.

[Close] buttons

Click this button to close the Source-Specific Preset Position window.

12.4.2 Mail sending when an alarm is generated

On the [Alarm] tab of the Alarm page, press [E-mail notification setup] in [Camera action on alarm].

→12.1 [\[Alarm\] to set alarm operation](#)

Refer to the following for the setting method.

→14.2.1 [Set mail sending](#)

12.4.3 Set up FTP/SFTP transmission when an alarm is generated

On the [Alarm] tab of the Alarm page, press [FTP/SFTP setup] in [Camera action on alarm].

→12.1 [\[Alarm\] to set alarm operation](#)

Refer to the following for the setting method.

→14.2.2 [Configuring FTP/SFTP transmission function](#)



[Note:]

- Only models with FTP/SFTP functions can be set.
- The factors displayed differ depending on the function of the model.
- Refer to the catalog specifications for the functions installed in each model.

12 [Alarm] to set the alarm

12.4 [Alarm] to set alarm linkage operation

| | |
|--------------------------------------------------------------------------------------------------------------------------------------|------------------------------------------------------------------------------------------------------------------------------------------------------------------------------------------------------------------------------------------------------------------------------------------------------------------------------------------------------------------------------------------------------------------------------------------------|
| Transmission protocol | <input type="radio"/> FTP <input checked="" type="radio"/> SFTP |
| Alarm setting (Server 1) | |
| Alarm image transmission | <input type="radio"/> On <input checked="" type="radio"/> Off |
| Directory name | <input type="text"/> |
| File name | <input type="checkbox"/> Terminal 1 <input type="checkbox"/> Terminal 2 <input type="checkbox"/> Terminal 3 <input type="checkbox"/> VMD <input type="checkbox"/> SCD <input type="checkbox"/> Auto track <input type="checkbox"/> Command alarm <input type="checkbox"/> Audio detection <small>* For alarms by the "Ext. software", alarm images will be transmitted only by configuring the alarm image SFTP transmission.</small> |
| FTP transmission retry | <input type="radio"/> On <input type="radio"/> Off |
| Pre alarm | Transmission interval: <input type="text" value="10 mins"/> Maximum number of images: <input type="text" value="10 pictures"/> Recording duration: <input type="text"/> |
| Post alarm | Transmission interval: <input type="text" value="10 mins"/> Number of images: <input type="text" value="10 pictures"/> Recording duration: <input type="text"/> |
| Image capture size | <input type="text" value="JPEG(1)"/> |
| Alarm setting (Server 2) | |
| Alarm image transmission | <input type="radio"/> On <input checked="" type="radio"/> Off |
| Directory name | <input type="text"/> |
| File name | <input type="checkbox"/> Terminal 1 <input type="checkbox"/> Terminal 2 <input type="checkbox"/> Terminal 3 |
| <small>[FTP transmission retry] [Pre alarm] [Post alarm] [Image capture size] is the same as the [Alarm setting (Server 1)].</small> | |
| Periodic transmission settings | |
| Periodic image transmission | <input type="radio"/> On <input type="radio"/> Off |
| Directory name | <input type="text"/> |
| File name | <input type="radio"/> Name w/time&date <input type="radio"/> Name w/o time&date |
| Transmission interval | <input type="text" value="1s"/> |
| Image capture size | <input type="text" value="JPEG(1)"/> |
| <small>[Periodic image transmission] is available for [FTP Server 1], [SFTP Server 1].</small> | |
| SFTP server 1 settings | |
| SFTP server address | <input type="text"/> Example of entry: 192.168.0.10 |
| Port number | <input type="text"/> (1-65535) |
| Host key hash | SHA256: <input type="text"/> Example of entry: dqVcdVZl/2ySO5tz/R6YR+rbW6dnap6P743uIMV0cf0 |
| User name | <input type="text"/> |
| Password | <input type="text"/> |
| FTP Server 1 setting | |
| FTP server address | <input type="text"/> Example of entry: 192.168.0.10 |
| User name | <input type="text"/> |
| Password | <input type="text"/> |
| Control port | <input type="text"/> (1-65535) |
| FTP mode | <input type="radio"/> Passive <input type="radio"/> Active |
| SFTP server 2 settings | |
| SFTP server address | <input type="text"/> Example of entry: 192.168.0.10 |
| Port number | <input type="text"/> (1-65535) |
| Host key hash | SHA256: <input type="text"/> Example of entry: dqVcdVZl/2ySO5tz/R6YR+rbW6dnap6P743uIMV0cf0 |
| User name | <input type="text"/> |
| Password | <input type="text"/> |
| FTP server 2 settings | |
| FTP server address | <input type="text"/> Example of entry: 192.168.0.10 |
| User name | <input type="text"/> |
| Password | <input type="text"/> |
| Control port | <input type="text"/> (1-65535) |
| FTP mode | <input type="radio"/> Passive <input type="radio"/> Active |

12.4.4 Sets recording data to SD Memory Card when alarm is generated.

On the [Alarm] tab of the Alarm page, press [SD memory card setup] in [Camera action on alarm].

→12.1 [Alarm] to set alarm operation

Refer to the following for the setting method.

→8.2 [SD memory card] for setting SD Memory Cards

12.4.5 Sets unique alarm notification when an alarm is generated.

On the [Alarm] tab of the Alarm page, press [TCP alarm notification setup] in [Camera action on alarm].

→12.1 [Alarm] to set alarm operation

Refer to the following for the setting method.

→12.12.1 Set unique alarm notification

12.4.6 Sets HTTP alarm notification when an alarm is generated.

On the [Alarm] tab of the Alarm page, press [HTTP alarm notification setup] in [Camera action on alarm].

→12.1 [Alarm] to set alarm operation

Refer to the following for the setting method.

→12.12.2 Set the HTTP alarm notification

12.4.7 Set SNMP transmission when an alarm is generated.

On the [Alarm] tab of the Alarm page, press [To SNMP setting] in [Camera action on alarm].

→12.1 [Alarm] to set alarm operation

Refer to the following for the setting method.

→14.2.7 Set SNMP

12.5 [VMD area] for setting motion detection

Click [VMD area] on the Alarm page. Refer to the following how to display and operate the Advanced menu.

→5.1 How to display

→5.2 How to operate

Here, the area for detecting the movement of an object using the motion detector function is set. An alarm is activated when the movement of an object in the set area is detected.



[Note:]

- [PTZ] Up to four areas can be set for each preset position (up to 256).
- [PTZ] You can also set the alarm operation when the camera is at a position other than the preset position.
- [MULTI] [Compact] Up to four areas can be set for each camera.
- [New X Fixed-8MP][New X Fixed-6MP][New X Fixed-5MP]If [Image capture mode] is set to [60fps Mode] or [50fps Mode], [VMD] cannot be used.



[Important]

- When the motion detector function is used to detect the movement of an object, [Alarm notification] is displayed for confirmation.

→2.3.2 About live image pages

- [Alarm notification] is also displayed when the alarm input is received with the terminal alarm or when the command alarm is received.
- Depending on the network environment, notification may be delayed.
- If the [Image capture mode] of the [Basic] tabs is changed after the operation detection area is set, the operation detection area may be misaligned. Be sure to check the setting of the motion detection area again.
- When [Intelligent Auto] is set to [On], the operation detection alarm may be generated because the brightness of the entire image changes depending on the subject's condition. In this case, set one of the following settings.
 - Set [Illumination detection suppression] to [On] for motion detection.
 - Adjust the slider bar of the [Detection sensitivity] in the motion detection area to the [Low] direction.Adjust the [Face priority level (Brightness)] slider bar of the intelligent auto to [-].
- The motion detector function is not intended to prevent theft, fire, etc. We will not be liable for any accident or damage.

Position Selection and Information Addition Setting Screen

12 [Alarm] to set the alarm

12.5 [VMD area] for setting motion detection



[Note:]

- [PTZ] Only the PTZ camera can be set for position selection and information addition setting screen.

Alarm VMD area SCD area Audio detection Notification

VMD area setting

Select a preset position

VMD information addition

Information addition On Off

Operation detection area setting

[Select a preset position]

Select the preset position number for which the motion detection area is to be set and press [Start] to set the motion detection area.

Select [except the preset positions] to set the operation detection area other than the preset position.

Addition of motion detection information

[Information addition]

12 [Alarm] to set the alarm

12.5 [VMD area] for setting motion detection

Sets whether to send the superimposed image data by [On] or [Off] by adding motion detection data to the image.

The operation detection information can be used by some of the search functions of the network disk recorder manufactured by us.

For details of the functions and settings, refer to the instruction manual of the connected device.

[Operation detection area setting screen](#)

Compact Dome cameras, New X Fixed Cameras

12 [Alarm] to set the alarm

12.5 [VMD area] for setting motion detection

Alarm VMD area SCD area Audio detection Notification



All areas

| Area | 1(White) | 2(Blue) | 3(Green) | 4(Red) |
|-------------------------|---------------------------------------------------------------|---------------------------------------------------------------|---------------------------------------------------------------|---------------------------------------------------------------|
| Status | <input type="radio"/> On <input checked="" type="radio"/> Off | <input type="radio"/> On <input checked="" type="radio"/> Off | <input type="radio"/> On <input checked="" type="radio"/> Off | <input type="radio"/> On <input checked="" type="radio"/> Off |
| Detection area | <input type="range" value="1"/> | <input type="range" value="1"/> | <input type="range" value="1"/> | <input type="range" value="1"/> |
| Detection sensitivity | <input type="range" value="8"/> | <input type="range" value="8"/> | <input type="range" value="8"/> | <input type="range" value="8"/> |
| Delete | <input type="button" value="Delete"/> | <input type="button" value="Delete"/> | <input type="button" value="Delete"/> | <input type="button" value="Delete"/> |
| Light detection control | <input type="radio"/> On | <input checked="" type="radio"/> Off | | |
| Area No. notification | TCP alarm notification >> | | | |

* When notifying alarm area numbers by the TCP alarm notification, set "Additional alarm data" to "On".

* Various functions working with VMD alarm do not work while this page is open. After setting, close this page.

VMD information addition

Information addition On Off

Corner cameras

12 [Alarm] to set the alarm

12.5 [VMD area] for setting motion detection

Alarm VMD area SCD area Audio detection Impact detection Casing open detection Notification

Area 1(White) 2(Blue) 3(Green) 4(Red) All areas

Status On Off On Off On Off On Off On Off

Detection area [Slider 0-1] [Slider 0-1] [Slider 0-1] [Slider 0-1]

Detection sensitivity [Slider Low-High] [Slider Low-High] [Slider Low-High] [Slider Low-High]

Delete [Delete] [Delete] [Delete] [Delete]

Light detection control On Off

Area No. notification [TCP alarm notification >>](#)

* When notifying alarm area numbers by the TCP alarm notification, set "Additional alarm data" to "On".

* Various functions working with VMD alarm do not work while this page is open. After setting, close this page.

VMD information addition

Information addition On Off

Set

[Area]

When the motion detection area is selected in the image, it is set in order from Area 1.

[All areas] buttons

Clicking this button selects the entire area as the motion detection area and sets it to the

[1(White)] of [Area].

[Status]

Enable/disable operation detection.

[Enable]: Operation detection is performed.

[Disabled]: Operation detection is not performed.

[Detection area]

Set the area for detecting movement of object in the motion detection area with the slider bar.

The smaller the set value, the smaller the object movement will be detected. The current setting (1 to 10) is displayed to the right of the slider bar.

[Detection sensitivity]

Use the slider bar to set the sensitivity for detecting movement in the area. Individual settings can be made for each area. The larger the set value, the easier it is to sense the movement.

The current setting (1 (Low) to 15 (High)) is displayed under the slider bar.

[Delete] buttons

Click the area button to delete the area frame.

[Light detection control]

Use the [On] and [Off] buttons to specify whether or not the operation is not detected due to changes in the illumination.



[Important]

- If the lighting intensity is small, it may be impossible to suppress it.
- When the illumination detection suppression is set to [On] and a object movement is detected throughout the window, operation detection may not be performed.
- If [Camera title on screen display] is set to [On], the accuracy of motion detection may be reduced.

[Area No. notification]

Clicking [TCP alarm notification setup >>] displays the [Transmission] tabs on the Alarm Page.

→ [12.1 \[Alarm\] to set alarm operation](#)

[Addition of motion detection information](#)

[Information addition]

12 [Alarm] to set the alarm

12.5 [VMD area] for setting motion detection

Adds motion detection information to images and sets on/off whether to transmit superimposed image data. The operation detection information can be used by some of the search functions of the network disk recorder manufactured by us. For details of the functions and settings, refer to the instruction manual of the connected device.

PTZ camera

Alarm **VMD area** SCD area Audio detection Notification



| | | | | |
|-----------------------------|---------------------------------------------------------------|---------------------------------------------------------------|---------------------------------------------------------------|---------------------------------------------------------------|
| except the preset positions | | | | All areas |
| Area | 1(White) <input type="checkbox"/> | 2(Blue) <input type="checkbox"/> | 3(Green) <input type="checkbox"/> | 4(Red) <input type="checkbox"/> |
| Status | <input type="radio"/> On <input checked="" type="radio"/> Off | <input type="radio"/> On <input checked="" type="radio"/> Off | <input type="radio"/> On <input checked="" type="radio"/> Off | <input type="radio"/> On <input checked="" type="radio"/> Off |
| Detection area | | | | |
| Detection sensitivity | | | | |
| Delete | Delete | Delete | Delete | Delete |
| Light detection control | <input type="radio"/> On <input checked="" type="radio"/> Off | | | |
| Area No. notification | TCP alarm notification >> | | | |

* When notifying alarm area numbers by the TCP alarm notification, set "Additional alarm data" to "On".

* Various functions working with VMD alarm do not work while this page is open. After setting, close this page.

Set **Back**

[Area]

When the motion detection area is selected in the image, it is set in order from Area 1.

[All areas] buttons

Clicking this button selects the entire area as the motion detection area and sets it to the [1(White)] of [Area].

[Status]

Enable/disable operation detection.

[On]: Operation detection is performed.

[Off]: Operation detection is not performed.

[Detection area]

Set the area of the slider bar to detect movement of the subject in the motion detection area. The smaller the set value, the smaller the movement of the subject is detected. The current setting (1 to 10) is displayed to the right of the slider bar.

[Detection sensitivity]

Use the slider bar to set the sensitivity for detecting movement in the area. Individual settings can be made for each area. The larger the set value, the easier it is to sense the movement.

The current setting (1 (Low) to 15 (High)) is displayed under the slider bar.

[Delete] buttons

Click the area button to delete the area frame.

[Light detection control]

Use the [On] and [Off] buttons to specify whether or not the operation is not detected due to changes in the illumination.



[Important]

- If the lighting intensity is small, it may be impossible to suppress it.
- When the illumination detection suppression is set to [On] and the subject with movement throughout the screen is detected, the operation detection may not be performed.

[Area No. notification]

Clicking [TCP alarm notification setup] displays the [Notification] tabs on the Alarm Page.

→ [12.1 \[Alarm\] to set alarm operation](#)

[Addition of motion detection information](#)

[Information addition]

Adds motion detection information to images and sets on/off whether to transmit superimposed

- 12 [Alarm] to set the alarm
- 12.5 [VMD area] for setting motion detection

image data. The operation detection information can be used by some of the search functions of the network disk recorder manufactured by us. For details of the functions and settings, refer to the instruction manual of the connected device.

Multi-directional camera

Alarm
VMD area
SCD area
Notification



Cam. 1 ▾

| Area | 1(White) | 2(Blue) | 3(Green) | 4(Red) |
|-------------------------|-------------------------------------------------------------------------------------------------------------------------------------------------------------------------------------------------------------------------------------------------------------------------------------------------------------------------------------------------------------------------------------------------------------------------------------------------------------------------------------------------------------------------------------------------------------------|-------------------------------------------------------------------------------------------------------------------------------------------------------------------------------------------------------------------------------------------------------------------------------------------------------------------------------------------------------------------------------------------------------------------------------------------------------------------------------------------------------------------------------------------------------------------|-------------------------------------------------------------------------------------------------------------------------------------------------------------------------------------------------------------------------------------------------------------------------------------------------------------------------------------------------------------------------------------------------------------------------------------------------------------------------------------------------------------------------------------------------------------------|-------------------------------------------------------------------------------------------------------------------------------------------------------------------------------------------------------------------------------------------------------------------------------------------------------------------------------------------------------------------------------------------------------------------------------------------------------------------------------------------------------------------------------------------------------------------|
| Status | <input type="radio"/> On <input checked="" type="radio"/> Off | <input type="radio"/> On <input checked="" type="radio"/> Off | <input type="radio"/> On <input checked="" type="radio"/> Off | <input type="radio"/> On <input checked="" type="radio"/> Off |
| Detection area | <div style="display: flex; align-items: center;"> <div style="width: 100px; border-bottom: 1px solid #ccc; position: relative;"> <div style="position: absolute; left: 0; top: -5px; width: 10px; height: 10px; background-color: #ccc;"></div> <div style="position: absolute; right: 0; top: -5px; width: 10px; height: 10px; background-color: #ccc;"></div> </div> 1 </div> | <div style="display: flex; align-items: center;"> <div style="width: 100px; border-bottom: 1px solid #ccc; position: relative;"> <div style="position: absolute; left: 0; top: -5px; width: 10px; height: 10px; background-color: #ccc;"></div> <div style="position: absolute; right: 0; top: -5px; width: 10px; height: 10px; background-color: #ccc;"></div> </div> 1 </div> | <div style="display: flex; align-items: center;"> <div style="width: 100px; border-bottom: 1px solid #ccc; position: relative;"> <div style="position: absolute; left: 0; top: -5px; width: 10px; height: 10px; background-color: #ccc;"></div> <div style="position: absolute; right: 0; top: -5px; width: 10px; height: 10px; background-color: #ccc;"></div> </div> 1 </div> | <div style="display: flex; align-items: center;"> <div style="width: 100px; border-bottom: 1px solid #ccc; position: relative;"> <div style="position: absolute; left: 0; top: -5px; width: 10px; height: 10px; background-color: #ccc;"></div> <div style="position: absolute; right: 0; top: -5px; width: 10px; height: 10px; background-color: #ccc;"></div> </div> 1 </div> |
| Detection sensitivity | <div style="display: flex; align-items: center;"> <div style="width: 100px; border-bottom: 1px solid #ccc; position: relative;"> <div style="position: absolute; left: 0; top: -5px; width: 10px; height: 10px; background-color: #ccc;"></div> <div style="position: absolute; right: 0; top: -5px; width: 10px; height: 10px; background-color: #ccc;"></div> </div> <div style="margin-left: 5px;"> Low High </div> </div> | <div style="display: flex; align-items: center;"> <div style="width: 100px; border-bottom: 1px solid #ccc; position: relative;"> <div style="position: absolute; left: 0; top: -5px; width: 10px; height: 10px; background-color: #ccc;"></div> <div style="position: absolute; right: 0; top: -5px; width: 10px; height: 10px; background-color: #ccc;"></div> </div> <div style="margin-left: 5px;"> Low High </div> </div> | <div style="display: flex; align-items: center;"> <div style="width: 100px; border-bottom: 1px solid #ccc; position: relative;"> <div style="position: absolute; left: 0; top: -5px; width: 10px; height: 10px; background-color: #ccc;"></div> <div style="position: absolute; right: 0; top: -5px; width: 10px; height: 10px; background-color: #ccc;"></div> </div> <div style="margin-left: 5px;"> Low High </div> </div> | <div style="display: flex; align-items: center;"> <div style="width: 100px; border-bottom: 1px solid #ccc; position: relative;"> <div style="position: absolute; left: 0; top: -5px; width: 10px; height: 10px; background-color: #ccc;"></div> <div style="position: absolute; right: 0; top: -5px; width: 10px; height: 10px; background-color: #ccc;"></div> </div> <div style="margin-left: 5px;"> Low High </div> </div> |
| Delete | <div style="display: flex; align-items: center;"> <div style="width: 100px; border-bottom: 1px solid #ccc; position: relative;"> <div style="position: absolute; left: 0; top: -5px; width: 10px; height: 10px; background-color: #ccc;"></div> <div style="position: absolute; right: 0; top: -5px; width: 10px; height: 10px; background-color: #ccc;"></div> </div> 8 </div> <div style="text-align: center; margin-top: 5px; background-color: black; color: white; padding: 2px 5px; font-weight: bold;">Delete</div> | <div style="display: flex; align-items: center;"> <div style="width: 100px; border-bottom: 1px solid #ccc; position: relative;"> <div style="position: absolute; left: 0; top: -5px; width: 10px; height: 10px; background-color: #ccc;"></div> <div style="position: absolute; right: 0; top: -5px; width: 10px; height: 10px; background-color: #ccc;"></div> </div> 8 </div> <div style="text-align: center; margin-top: 5px; background-color: black; color: white; padding: 2px 5px; font-weight: bold;">Delete</div> | <div style="display: flex; align-items: center;"> <div style="width: 100px; border-bottom: 1px solid #ccc; position: relative;"> <div style="position: absolute; left: 0; top: -5px; width: 10px; height: 10px; background-color: #ccc;"></div> <div style="position: absolute; right: 0; top: -5px; width: 10px; height: 10px; background-color: #ccc;"></div> </div> 8 </div> <div style="text-align: center; margin-top: 5px; background-color: black; color: white; padding: 2px 5px; font-weight: bold;">Delete</div> | <div style="display: flex; align-items: center;"> <div style="width: 100px; border-bottom: 1px solid #ccc; position: relative;"> <div style="position: absolute; left: 0; top: -5px; width: 10px; height: 10px; background-color: #ccc;"></div> <div style="position: absolute; right: 0; top: -5px; width: 10px; height: 10px; background-color: #ccc;"></div> </div> 8 </div> <div style="text-align: center; margin-top: 5px; background-color: black; color: white; padding: 2px 5px; font-weight: bold;">Delete</div> |
| Light detection control | <input type="radio"/> On <input checked="" type="radio"/> Off | | | |
| Area No. notification | TCP alarm notification >> | | | |

* When notifying alarm area numbers by the TCP alarm notification, set "Additional alarm data" to "On".

* Various functions working with VMD alarm do not work while this page is open. After setting, close this page.

VMD information addition

Information addition On Off

Set

[Camera selection]

Select the camera to set the area from each camera.

[Area]

When the motion detection area is selected in the image, it is set in order from Area 1.

[Status]

Enable/disable operation detection.

[On]: Operation detection is performed.

[Off]: Operation detection is not performed.

[Detection area]

Set the area of the slider bar to detect movement of the subject in the motion detection area. The smaller the set value, the smaller the movement of the subject is detected. The current setting (1 to 10) is displayed to the right of the slider bar.

[Detection sensitivity]

Use the slider bar to set the sensitivity for detecting movement in the area. Individual settings can be made for each area. The larger the set value, the easier it is to sense the movement.

The current setting (1 (Low) to 15 (High)) is displayed under the slider bar.

[Delete] buttons

Click the area button to delete the area frame.

[Light detection control]

Use the [On] and [Off] buttons to specify whether or not the operation is not detected due to changes in the illumination.



[Important]

- If the lighting intensity is small, it may be impossible to suppress it.
- When the illumination detection suppression is set to [On] and the subject with movement throughout the screen is detected, the operation detection may not be performed.

[Area No. notification]

Clicking [TCP alarm notification setup] displays the [Notification] tabs on the Alarm Page.

→ [12.1 \[Alarm\] to set alarm operation](#)

12 [Alarm] to set the alarm

12.6 [VMD area] to set the motion detection area

Addition of motion detection information

[Information addition]

Sets whether to send the superimposed image data by [On] or [Off] by adding motion detection data to the image. The operation detection information can be used by some of the search functions of the network disk recorder manufactured by us. For details of the functions and settings, refer to the instruction manual of the connected device.

12.6 [VMD area] to set the motion detection area

Set the motion detection area.



[Important]

•All alarms are not detected while the setting is being changed on the setting screen. Close the setting screen after setting is completed.

- 1 When you drag the mouse on the image and specify an area, the specified area is set to Area [1(White)] and a frame is displayed.

Areas are set from the first to the first area number. The color next to the area number indicates the corresponding color of the frame. In addition, the frame [Status] to be set for the area becomes [On].

12 [Alarm] to set the alarm

12.6 [VMD area] to set the motion detection area

Alarm **VMD area** SCD area Audio detection Notification

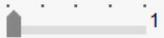
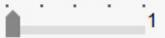
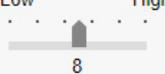

except the preset positions **All areas**

| Area | 1(White) <input type="checkbox"/> | 2(Blue) <input checked="" type="checkbox"/> | 3(Green) <input checked="" type="checkbox"/> | 4(Red) <input checked="" type="checkbox"/> |
|-------------------------|---------------------------------------------------------------------------------------------------|---------------------------------------------------------------------------------------------------|----------------------------------------------------------------------------------------------------|-----------------------------------------------------------------------------------------------------|
| Status | <input checked="" type="radio"/> On <input type="radio"/> Off | <input type="radio"/> On <input checked="" type="radio"/> Off | <input type="radio"/> On <input checked="" type="radio"/> Off | <input type="radio"/> On <input checked="" type="radio"/> Off |
| Detection area |  1 |  1 |  1 |  1 |
| Detection sensitivity | Low  High 8 | Low  High 8 | Low  High 8 | Low  High 8 |
| Delete | Delete | Delete | Delete | Delete |
| Light detection control | <input type="radio"/> On <input checked="" type="radio"/> Off | | | |
| Area No. notification | TCP alarm notification >> | | | |

* When notifying alarm area numbers by the TCP alarm notification, set "Additional alarm data" to "On".
* Various functions working with VMD alarm do not work while this page is open. After setting, close this page.

Set **Back**

- 2 Set the [Detection area] [Detection sensitivity] with the slider bar. For [Detection area] [Detection sensitivity], see the following.

→12.5 [VMD area] for setting motion detection

The area displayed and the movement detection status at the detection sensitivity are displayed in [Detection area]. Modify areas and [Detection area] [Detection sensitivity] as required.

- 3 When you are finished, press [Set].



[Important]

- If you do not press the [Set] buttons, the settings will not be confirmed.

- 4 To disable the motion detection area, change the [Status] of the area in question to [Off] and click [Set]. The disabled box will be dotted.

When disabled, no alarm is generated even if there is a change in the area.

- 5 To delete an area for motion detection, click [Delete] in the area to delete to delete the area frame.
- 6 When [Set] is clicked, the settings are reflected in the computer.

12.7 [SCD area] to set up undesired detection



[Note:]

- [New X Fixed-8MP][New X Fixed-6MP][New X Fixed-5MP] If [Image capture mode] is set to [60fps Mode] or [50fps Mode], [SCD] cannot be used.

This section sets the disturbance detection function.

The jamming detection function activates an alarm when the camera detects a change in the subject by covering the camera with a cloth or a lid or changing the orientation of the camera significantly. You can set up one area. When disturbance is detected in the set area, an alarm is activated.



[Important]

- In the following cases, the undesired signal detection function will not work for a while.
 - After turning on the power
 - after changing the undesired detection setting
 - when the image angle of the machine changes
 - When a disturbance is detected using the disturbance detection function, [Alarm notification] is displayed for confirmation.
 - [2.3.2 About live image pages](#)
 - [Alarm notification] is also displayed when an alarm input is received with a terminal alarm or other alarm such as an operation detection alarm is generated.

- If you configure the disturbance detection area and then change the [Image rotation] or [Image] tab [Image capture mode] on the [Basic] tab, the disturbance detection area may shift. Be sure to reconfirm the settings of the disturbance detection area.
- In the following cases, disturbance detection may not be detected.
 - If only part of the screen is covered or transparent
 - when the camera is oriented in a similar manner before and after the camera
 - if a privacy zone is set
- If the [Detection Time] setting of the disturbance detection function is shorter than the [Dwell time] setting of the [Black-and-white switching], the disturbance detection alarm may be generated when the color image and black-and-white image are switched. The [Detection Time] setting of the disturbance detection function can be improved by making it longer than the [Dwell time] of [Black/white switching].
- When the color of the image is close to monochrome, it is difficult to detect disturbance. If undesired detection is difficult, increase the [Detection sensitivity] setting of the undesired detection function or increase the area of the undesired detection function.
- When [Intelligent Auto] is set to [On], the undesired detection alarm may be generated because the brightness of the entire image changes depending on the subject's condition. In this case, set one of the following settings.
 - Set [Detection sensitivity] to a low setting.
 - Set [Detection Time] for a long time.
 - Adjust the [Face priority level (Brightness)] slider bar of the intelligent auto to [-].
- The disturbance detection function is not used to prevent theft, fire, etc. We will not be liable for any accident or damage.

[Camera selection]

Select the camera to set the area from each camera.



[Note:]

- [MULTI] [Camera selection] can be selected only for Multi-directional cameras.

[Area]

12 [Alarm] to set the alarm

12.8 [SCD area] to set up undesired detection areas

Set the disturbance detection area in the image.

[All areas]

Click this button to set the entire area as a disturbance detection area.

[Status]

Use the [On] and [Off] buttons to specify whether or not to perform undesired detection.

[On]: Detects disturbance.

[Off]: No disturbance detection is performed.

[Detection area]

Set the area for detecting movement of the subject in the disturbance detection area to [Small], [Middle] and [Large].

[Detection sensitivity]

The sensitivities for detection of disturbance in the area are set from [Very Low], [Low], [Middle], and [High].

[Detection Time]

Sets the time from when the subject changes to when the disturbance detection alarm is activated.

The alarm does not operate when the subject changes only within the set time.

[3s]/ [5s]/ [10s]/ [30s]/ [1min]

[Delete] buttons

Click to delete the area frame.

Addition of undesired detection information

[Information addition]

Set [On] and [Off] to send superimposed image data by adding undesired detection data to the image.



[Note:]

- Additional disturbance detection information is not used by our network disk recorders (as of April 2022).

12.8 [SCD area] to set up undesired detection areas

Set the disturbance detection area.

12 [Alarm] to set the alarm

12.8 [SCD area] to set up undesired detection areas



[Important]

•All alarms are not detected while the setting is being changed on the setting screen. Close the setting screen after setting is completed.

- 1 Select the camera from which the area is to be set by [Camera selection].



[Note:]

•[MULTI] [Camera selection] can be selected only for Multi-directional cameras.

- 2 Clicking [All areas] selects the entire area as the disturbance detection area and displays a frame around the entire screen. Also, [Status] is set to [On].

12 [Alarm] to set the alarm

12.8 [SCD area] to set up undesired detection areas

| Alarm | VMD area | SCD area | Audio detection | Notification |
|-------|----------|----------|-----------------|--------------|
|-------|----------|----------|-----------------|--------------|

| All areas | |
|-----------------------|---------------------------------------------------------------|
| Status | <input checked="" type="radio"/> On <input type="radio"/> Off |
| Detection area | Middle ▾ |
| Detection sensitivity | Middle ▾ |
| Detection time | 3s ▾ |
| Delete | Delete |

* Various functions working with SCD alarm do not work while this page is open.
After setting, close this page.

| SCD information addition | |
|--------------------------|---------------------------------------------------------------|
| Information addition | <input type="radio"/> On <input checked="" type="radio"/> Off |

Set

When you drag the mouse on the image and specify an area, the specified area is set to the area (white) and a frame is displayed. In addition, [Status] becomes [On].

12 [Alarm] to set the alarm

12.8 [SCD area] to set up undesired detection areas

Alarm VMD area **SCD area** Audio detection Notification



All areas

| | |
|-----------------------|---------------------------------------------------------------|
| Status | <input checked="" type="radio"/> On <input type="radio"/> Off |
| Detection area | Middle ▾ |
| Detection sensitivity | Middle ▾ |
| Detection time | 3s ▾ |
| Delete | Delete |

* Various functions working with SCD alarm do not work while this page is open.
After setting, close this page.

SCD information addition

| | |
|----------------------|---------------------------------------------------------------|
| Information addition | <input type="radio"/> On <input checked="" type="radio"/> Off |
|----------------------|---------------------------------------------------------------|

Set

- 3 Set [Detection area] [Detection sensitivity] [Discovery Time]. For [Detection area] [Detection sensitivity], refer to the following.
→ [12.7 \[SCD area\] to set up undesired detection](#)
Change the area or [Detection area] [Detection sensitivity] as required.
- 4 When you have finished setting, press [Set].



[Important]

• If you do not press the [Set] buttons, the settings will not be confirmed.

- 5 To disable the disturbance detection area, change [Status] to [Off] and press [Set]. Click this button to display a dotted line with the disabled frame color. When disabled, no alarm is generated by undesired disturbance detection.
- 6 To delete the undesired detection area, press [Delete]. Click to clear the area frame.



[Note:]

- If you want to reconfigure the disturbance detection area, you must clear the area frame by clicking [Delete] button.

- 7 When [Set] is clicked, the settings are reflected in the computer.

12.9 [Audio detection] for setting sound detection

Click [Audio detection] on the Alarm page. Refer to the following how to display and operate the Advanced menu.

→5.1 [How to display](#)

→5.2 [How to operate](#)

Here, the sound detection setting is performed.



[Note:]

- [New X Fixed-8MP][New X Fixed-5MP] If [Image capture mode] is set to [60fps Mode] or [50fps Mode], [Audio detection] cannot be used.



[Important]

- When the sound detection function is used to detect sound, [Alarm generation notification] is displayed so that the sound detection is confirmed.
- [Alarm notification] is also displayed when the alarm input is received with the terminal alarm or when the command alarm is received.
- Depending on the network environment, notification may be delayed.
- The sound detection function is not suitable for applications that require high reliability at all times (systems designed to prevent problems). We will not be liable for any accident or damage.

12 [Alarm] to set the alarm

12.9 [Audio detection] for setting sound detection

| Alarm | VMD area | SCD area | Audio detection | Notification |
|------------------------------------------------------------------------------------------------------------------------------------------------|-----------------------------------------------------------------------------------------------------------|----------|-----------------|--------------|
|  | | | | |
| Audio detection | <input type="radio"/> On <input checked="" type="radio"/> Off | | | |
| Detection sensitivity | Middle ▾ | | | |
| AI analytics target | <input type="checkbox"/> Gunshot <input type="checkbox"/> Yell | | | |
| | <input type="checkbox"/> Vehicle horn <input type="checkbox"/> Glass break <input type="checkbox"/> Other | | | |
| <small>* Various functions working with Audio detection alarm do not work while this page is open. After setting, close this page.</small> | | | | |
| Set | | | | |

[Audio detection]

ON/OFF is used to specify whether or not to perform sound detection.

[On]: Sound detection is performed.

[Off]: Sound detection is not performed.

[Detection sensitivity]

Select the sensitivity of detection from the [Low] [Middle] [High].



[Note:]

- When installing cameras indoors, it is recommended that [Sense Level] be set to [Low].

[AI analytics target]

Select the target for detecting AI tone identification.

- [Gunshot]: Detects gunshot, explosive, shock and bursting sounds.
- [Yell]: It detects human screams and cries.

· [Vehicle horn]: Detects the horn of the car.

· [Glass break]: Detects the cracking of windows.

[Other]: Detects other sounds than gunshot, screech, horn, or cracking of glasses.



[Note:]

• In the following cases, the target sound may not be detected.

-if the duration of the cry/horn/glass break is shorter than 1 second

When the difference between the noise of interest and ambient noise is less than 6 dB

If the rain hits the camera microphone directly

• When multiple types of target sounds are generated at the same time, only one type of alarm is notified.

• The message ID of the unique alarm notification for AI sound identification is as follows.

Used for registering sound identification alarms with a recorder or our video monitoring software.

BOOK: 70

--a broken glass: 71

-horn: 72

--shriek: 73

Other: 55

• When an alarm notification for AI sound identification is received by a recorder, etc., the alarm cannot be received by a recorder etc. during the alarm mask period.

12.10 [Impact detection] for setting impact detection

Click [Impact detection] on the Alarm page. Refer to the following how to display and operate the Advanced menu.

→[5.1 How to display](#)

→[5.2 How to operate](#)

Here, the impact detection setting is performed.



[Note:]

- [Corner] Impact detection can be set only for Corner cameras.



[Important]

- When the impact detection function is used to detect impact, [Alarm generation notification] is displayed so that the impact detection is confirmed.
- All alarms are not detected while changing settings on the setting screen. Close the setting screen after completing the setting.
- [Alarm notification] is also displayed when the alarm input is received with the terminal alarm or when the command alarm is received.
- Depending on the network environment, notification may be delayed.
- The impact detection function is not suitable for applications that require high reliability at all times (systems designed to prevent problems). We will not be liable for any accident or damage.

12 [Alarm] to set the alarm

12.10 [Impact detection] for setting impact detection

The screenshot displays the 'Impact detection' settings page. At the top, there is a navigation bar with tabs for 'Alarm', 'VMD area', 'SCD area', 'Audio detection', 'Impact detection', 'Casing open detection', and 'Notification'. The 'Impact detection' tab is selected. Below the navigation bar is a video feed showing a street scene with a bus and a car. Underneath the video, there are two rows of controls. The first row is for 'Impact detection', with 'On' selected (indicated by a blue dot) and 'Off' as an option. The second row is for 'Detection level', featuring a slider bar with a blue indicator at 60, and a 'Max. value' section showing 28 with a 'Reset' button. Below these controls, there is a paragraph of text: '* Various functions working with Impactdetection alarm do not work while this page is open. After setting, close this page.' and '*When an impact is applied to the camera, a blue bar will be displayed to indicate the strength of the impact.The maximum value of the impact received by the camera is displayed in the "Max. value" section.Use this as a guide when setting the "Detection level".The displayed "Max. value" will return to 0 when you press the "Reset" button.' At the bottom of the interface is a large 'Set' button.

[Impact detection]

Use On/Off to set whether or not to perform impact detection.

[On]:Performs impact detection.

[Off]:Does not perform impact detection.

[Detection level]

Use the slider bar to set the threshold at which the impact is detected.

You can adjust the value from 1 to 255. Moving in the [+] direction weakens the sensitivity for detecting shocks, allowing you to detect only large shocks. [-] When it is moved in the direction, the sensitivity to detect the impact becomes stronger, and even small impacts can be detected.



[Note:]

- When an impact is applied to the camera while [Impact detection] is set to [On], a blue bar indicating the impact intensity is displayed. The maximum impact received by the camera is displayed in the [Max.value:]. Use this as a guide when setting the [Detection level]. Press [Reset] to return to 0 for [Max.value:] displayed.

12.11 [Casing open detection] for setting opening detection

Click [Casing open detection] on the Alarm page. Refer to the following how to display and operate the Advanced menu.

→5.1 [How to display](#)

→5.2 [How to operate](#)

Here, the opening detection setting is performed.



[Note:]

- [Corner] Opening detection can be set only for Corner cameras.



[Important]

- When the opening detection function is used to detect opening, [Alarm generation notification] is displayed so that the opening detection is confirmed.
- All alarms are not detected while changing settings on the setting screen. Close the setting screen after completing the setting.
- [Alarm notification] is also displayed when the alarm input is received with the terminal alarm or when the command alarm is received.
- Depending on the network environment, notification may be delayed.
- The opening detection function is not suitable for applications that require high reliability at all times (systems designed to prevent problems). We will not be liable for any accident or damage.

12 [Alarm] to set the alarm

12.11 [Casing open detection] for setting opening detection

| | | | | | | |
|-------|----------|----------|-----------------|------------------|------------------------------|--------------|
| Alarm | VMD area | SCD area | Audio detection | Impact detection | Casing open detection | Notification |
|-------|----------|----------|-----------------|------------------|------------------------------|--------------|



| | | |
|-----------------------|----------------------------------------------------------------------------------------|--------------------------------------------------------------------------------------------|
| Casing open detection | <input type="radio"/> On | <input checked="" type="radio"/> Off |
| Detection type | <input type="radio"/> Alarm notification when the front cover both opening and closing | <input checked="" type="radio"/> Alarm notification continue while the front cover is open |

* Various functions working with Casing open detection alarm do not work while this page is open.
After setting, close this page.

Set

[Casing open detection]

Use On/Off to set whether or not to perform opening detection.

[On]:Performs opening detection.

[Off]:Does not perform opening detection.

[Detection type]

Select an action to notify an alarm.

[Alarm notification when the front cover both opening and closing]:Notifies you of an alarm when the camera front cover is opened and closed.

[Alarm notification continue while the front cover is open]:Alarm continues while the front cover of the camera is open.



[Note:]

- If [Alarm notification when the front cover both opening and closing] is selected, an alarm is notified every time the front cover of the camera is opened or closed regardless of the interval of the alarm non-detection time.
- If [Alarm notification continue while the front cover is open] is selected, the alarm is periodically notified at the interval of the alarm non-detection time if the front cover of the camera is open.
- If you select [Alarm notification continue while the front cover is open], no alarm notification is given even if the front cover of the camera is closed.

12.12 [Notification] to set alarm notification

Click [Notification] on the Alarm page. Refer to the following how to display and operate the Advanced menu.

→5.1 [How to display](#)

→5.2 [How to operate](#)

This is used to set the unique alarm notification and HTTP alarm notification.

12.12.1 Set unique alarm notification

[Unique alarm notification](#)

[TCP alarm notification]

ON/OFF is used to specify whether or not to perform unique alarm notification in the following cases.

- When an alarm is generated (unique alarm notification destination: [Alarm] field)
- When notifying the remaining capacity of the SD Memory Card (unique alarm notifying destination: [Diag.] field)
- When there is insufficient space on the SD Memory Card (unique alarm notification destination: [Diag.] field)
- When recognizing an SD Memory Card error (Original alarm notification destination: [Diag.] field)
- When writing to SD Memory Card is failed (unique alarm notification destination: [Diag.] field)
- Upon expiration of the trial period of the function extension software (original alarm notification destination: [Diag.] field)

12 [Alarm] to set the alarm

12.12 [Notification] to set alarm notification



[Note:]

- Notification of unique alarms is made in the order from [Notify Party 1] (only when checked in the [Alarm] or [Diag.] field).

[Additional alarm data]

Sets ON/OFF whether the detection area number of the operation detection alarm is notified by the unique alarm.

[Destination port]

Set the receiving port number of the unique alarm notification destination.

Settable range: 1~65535

The following port numbers cannot be set because they are used by this computer.

20、 21、 22、 23、 25、 42、 53、 67、 68、 69、 80 110、 123、 161、 162、 443、 554、 995、 1883、 8883、 10669、 10670、 59000~61000



[Note:]

- [MULTI] The port numbers 32768 to 49151 cannot be set.

[Retry times]

Set the number of retries when the unique alarm notification cannot be performed.

Settable range: 0~30

Destination of notification

PTZ camera, Fixed cameras



[Note:]

- Only PTZ cameras are displayed for auto-tracking.

[Address 1] ~ [Address 8]

Set the unique alarm notification destination with IP address or host name. You can set up to 8 notification destinations.

[Alarm] field: When the checkbox is checked, the alarm will be notified.

[Diag.] field: When checked, notification of the remaining capacity of the SD Memory Card, lack of free space of the SD Memory Card, SD Memory Card recognition error, SD Memory Card write error, and expiration of the trial period of the function extension software are notified.

[Destination server address] field: Enter the IP address or host name of the notification destination.

12 [Alarm] to set the alarm

12.12 [Notification] to set alarm notification

Input Characters:One-byte alphanumeric and one-byte symbols: . _ -

To delete the specified notification destination, press [Delete] for the notification destination to be deleted.

[Auto track cooperation]

ON/OFF is used to set whether or not automatic tracking linkage is set.

When [Auto track cooperation] is set to [On], alarm notification is executed only when [Alarm Area No.] matches the [Alarm area] number set for auto-tracking alarm. Alarm notification other than the automatic tracking alarm is not performed. When using the Auto Tracking Coordination function, set the alarm area condition in Auto Tracking to [On].

[Alarm area No.]

Settable range:1~4



[Important]

- If you want to enter a hostname for [Destination address], you must configure the DNS on the [Network] tab of the network page.

→[14.1 Networking \[Network\]](#)

- Make sure that the notification destination is set correctly. If the notification destination does not exist, a proprietary alarm notification delay or transmission failure may occur.

Multi-directional camera

[Address 1] ~ [Address 48]

Set the unique alarm notification destination with IP address or host name. You can set up to 48 notifications.

[Alarm] field:When the checkbox is checked, the alarm will be notified.

[Diag.] field:When checked, notification of the remaining capacity of the SD Memory Card, lack of free space of the SD Memory Card, SD Memory Card recognition error, SD Memory Card write error, and expiration of the trial period of the function extension software are notified.

[Destination server address] field:Enter the IP address or host name of the notification destination.

Input Characters:One-byte alphanumeric and one-byte symbols: . _ -

To delete the specified notification destination, press [Delete] for the notification destination to be deleted.

[Notification per Camera]

ON/OFF is used to specify whether or not to execute the transmission setting by camera.

When [Notification per Camera] is set to [On], [Camera No.] is notified when [Camera No.] matches the number of the camera that generated the operation detection alarm or when [Camera No.] matches the camera number of the clicked live display.

12 [Alarm] to set the alarm

12.12 [Notification] to set alarm notification



[Note:]

- [MULTI] This item is not displayed when [Image capture mode] is in Quad/Dual mode.

[camera No.]

Settable range: 1 to 4



[Note:]

- [MULTI] This item is not displayed when [Image capture mode] is in Quad/Dual mode.

[Notification per VMD area]

ON/OFF is used to set whether the operation detection area-specific transmission is set.

When [Notification per VMD area] is set to [On], alarm notification is executed only when [Alarm Area No.] matches the [Alarm area] number set for the operation detection alarm. Alarm notification other than the operation detection alarm is not performed. When using the operation detection area-specific transmission function, set the alarm area status for operation detection to [On].

[Alarm area No.]

Settable range: 1~8



[Important]

- If you want to enter a hostname for [Destination address], you must configure the DNS on the [Network] tab of the network page.

→ [14.1 Networking \[Network\]](#)

- Make sure that the notification destination is set correctly. If the notification destination does not exist, a proprietary alarm notification delay or transmission failure may occur.

12.12.2 Set the HTTP alarm notification

HTTP alarm notification

[Address 1] ~ [Address 5]

Set the IP address or host name of the HTTP server that notifies the HTTP alarm. You can set up to 5 notification destinations.

Input Characters: One-byte alphanumeric and one-byte symbols: . _ -

12 [Alarm] to set the alarm

12.12 [Notification] to set alarm notification

Example of entry:

Http://IP address: port number or http://host name: port number

Https://IP address: port number or https://host name: port number



[Note:]

- [MULTI_PTZ] Multi-directional camera with integrated Multi-directional/PTZ can be set up to Notification Destination 4.

[Alarm] field

When an alarm is generated, the HTTP alarm notification is executed.

[Diag.] filed

Select this to issue HTTP alarm notifications when the amount of free space remaining on the SD memory card is running low, when there is not enough free space on the SD memory card, when an SD memory card recognition error occurs, when an SD memory card write error occurs, and when the trial period for the function extension software will expire.

[Delete] buttons

When this button is clicked, all notifications, user names, passwords, and notification data set for the item are deleted.

[User name]

Enter the user name that accesses the HTTP server.

Number of characters that can be entered:0 to 63 characters

Characters that cannot be entered:Double-byte and single-byte symbols " & ; ¥

[Password]

Enter the password to access the HTTP server.

Number of characters that can be entered:0 to 63 characters

Characters that cannot be entered:Double-byte and single-byte symbols " &



[Note:]

- Basic or Digest authentication is performed by an HTTP server authentication request.

[Notification data]

Set the notification content to be added after the HTTP server set to [Address 1] ~ [Address 5].

Input Characters:Half mark alphanumeric characters and marks



[Note:]

- If the HTTP alarm function is enabled, the authentication information (user name, password) of the HTTP server may be leaked on the network when the alarm is notified to the HTTP server.
- The number of characters to be notified (including [http://]) and [Notification data] is limited to 256 characters.
- Be sure to enter the [Notification data] from the slash (/).
- If an HTTP alarm notification fails, it is listed in the system log.
- If [Notification data] is blank and [Set] is pressed, [/cgi-bin/comarm.cgi?CMD=01] is also set.

Example:

If [/cgi-bin/comalarms.cgi?CMD=01] is set as the notification destination and [/cgi-bin/comalarms.cgi?CMD=01] is set to the notification destination, the HTTP alarm notification with http://192.168.0.100/cgi-bin/commalm.cgi?CMD=01 is executed.

[PTZ linkage operation]

This is the setting to perform the operation in cooperation with the PTZ camera. The HTTPS URL of the PTZ camera is automatically displayed.

[Alarm] field

When checked, the PTZ camera works in conjunction with the camera.

[User name]

The Multi-directional camera administrator user name is automatically displayed.

[Password]

The Multi-directional camera administrator password is automatically displayed.

[Notification data]

It is displayed as blank.



[Note:]

- [MULTI_PTZ] [PTZ interlocked operation] can be set only for Multi-directional cameras with a Multi-directional/PTZ integrated camera.

13 [User mng.] to set authentication

On the user management page, authentication registration is performed to restrict users and PCs (IP addresses) that can be accessed from a PC, mobile terminal, or tablet terminal.

User-managed pages consist of the [User auth.], [Host auth.], [IEEE 802.1X], and [Data encryption] tabs.



[Note:]

- The items that can be set differ depending on the function of the model.
- Refer to the catalog specifications for the functions installed in each model.

13.1 [User auth.] to configure user-authentication

On the Users Administration page, press the [User auth.] tab. Refer to the following how to display and operate the Advanced menu.

→[5.1 How to display](#)

→[5.2 How to operate](#)

Here, authentication settings are made to restrict users who can access the computer from a PC, mobile terminal, or tablet terminal. Up to 24 users can be registered.



[Note:]

- If you fail user authentication (authentication error) five or more times in 10 seconds from a PC with the same IP address, you will not be able to access the machine for 30 seconds.
- You can change the conditions and period when the machine becomes inaccessible.
→[13.6 \[Security\] to configure security](#)

[User auth.]

Use [On] and [Off] to set whether to authenticate users.

[Guest User]

Select whether to set unregistered users. Selecting [Use] enables you to configure both available and unavailable features for non-user-authenticated users.

[Authentication]

Set the authentication method to use for user authentication.

Digest or Basic: Use digest or basic authentication.

Digest: Use digest authentication.

Basic: Use basic authentication.



[Note:]

- To ensure security, [Digest] is recommended for [Authentication]. If you use [Digest or Basic] or [Basic], [User name] and [Password] may leak.
- If you change the [Authentication] setting, close the web browser and re-access it.

[User name registration]

At the time of new registration, a new username is registered in [User name]. By clicking [▼] on the [User name registration], you can check the registered users. Registered users are displayed in [Registered Username [Access level]]. (e.g., admin [1])

Clicking Change on the right-hand side displays the selected user [User name] and allows the user to change the password. You can delete the selected users by clicking [Delete].

[User name (1 to 32 characters)]

Provide User Name

Number of characters that can be entered: 1 to 32 characters

Characters that cannot be entered: Double-byte and single-byte symbols " & ; ¥



[Note:]

- Enter the registered user name and press [Register] to overwrite the user information.

[Password]/[Password (8 to 32 characters)]

Type a password.

Number of characters that can be entered: 8 to 32 characters

Characters that cannot be entered: Double-byte and single-byte symbols " &



[Note:]

- Enter case-sensitive data.
- Use at least three of the following passwords: uppercase alphabetic characters, lowercase alphabetic characters, numbers, and symbols.
- Configure the password so that it does not contain the user name.

[Access level]

Set the user access level from the following.

1. **[Administrator]**You can perform all of the operations of this product.
2. **[Camera control]**:Set the access level to camera control. The functions selected in [Access Level] can be operated.
3. **[Live only]**:Set the access level to live image display. The functions selected in [Access Level] can be operated.

[Access Level]

Select a function that can be used according to the user's access level (camera control, live image display, unregistered user).

•**If [User auth.] is set to [Off] and [Guest User] is set to [Not use]:**

[Access Level] items cannot be set. In addition, all buttons are displayed in the live picture, but authentication is required for the [Set] button.

•**If [User auth.] is set to [Off] and [Guest User] is set to [Use]:**

You can set the [Guest User] items.

•**If [User auth.] is set to [On]:**

[Guest User] items cannot be set.

Configure these features:

| | |
|--------------------------------------|-------------------------------------------------------------|
| Live image selection | Right to select the image to be displayed in live picture |
| Listen to | Setting authority of earpiece voice (heard on PC) |
| Speak to | Setting authority for voice transmission (speaking from PC) |
| Image update interval | Right to set the interval for updating the JPEG image |
| Snapshot | Snapshot operation privileges |
| Recording and playback (Log display) | Log display operation privileges |
| Manual recording/deletion | SD Memory Card saving/deletion privilege |
| Preset | Operation privileges for the preset position movement |
| Pan/tilt operation | Pan/tilt operation authority |

- 13 [User mng.] to set authentication
 - 13.2 [Host auth.] to configure host-authentication
-

| | |
|-------------------------|------------------------------------------------|
| Zoom operation | Zoom operation authority |
| Focus operation | Focus operation privileges |
| Automatic mode | Auto mode operation privileges |
| Brightness | Authority to set brightness |
| AUX | Aux setting authority |
| Preset position setting | Operation authority of preset position setting |



[Note:]

- The items that can be set differ depending on the function of the model.
- Refer to the catalog specifications for the functions installed in each model.

13.2 [Host auth.] to configure host-authentication

On the Users Administration page, press the [Host auth.] tab. Refer to the following how to display and operate the Advanced menu.

→5.1 [How to display](#)

→5.2 [How to operate](#)

Here, the host authentication setting that restricts the PC (IP address) to which the computer can be accessed is performed.

[Host auth.]

On/Off is used to specify whether or not to perform host authentication.



[Note:]

- Register the IP addresses of the PCs, and then set [Host auth.] to [On].
- User authentication is required when user authentication is [On], regardless of how hosted authentication is configured.

[IP address]

Enter the IP address of the PC to allow access to the computer. You cannot enter a host name as an IP address.



[Note:]

- If you enter IP Address/Mask Length for the subnet, you can restrict the PC that can be accessed for each subnet. For example, if you enter [192.168.0.1/24] and select [2. Camera control] as the access level, PCs [192.168.0.1] through [192.168.0.254] can access the computer at the [2. Camera control] access level.
- Enter the registered IP address and press [Register] to overwrite the host information.
- If the error message [Set Address] is displayed, the IP address of the PC may not be set correctly. Check the IP address of the PC.
- If you receive an error message [Register the [IP address] of the PC used for setting and then set [Host auth.] to [On]], the IP address of the PC may not be set correctly. Reaffirm the IP address setting of the PC.

[Access level]

Select the host access level from the following.

[1. Administrator]/[2. Camera control]/[3. Live only]

Please refer to the following for the access level.

→[13.1 \[User auth.\] to configure user-authentication](#)

[Host check]

Click [▼] on the [Host check] to check the IP addresses of registered hosts.

Hosts are displayed as Registered IP Addresses [Access level]. (e.g. 192.168.0.21 [1])

You can delete the selected hosts (IP addresses) by clicking [Delete].

13.3 [System] to set preference streams



[Note:]

- [MULTI] The priority stream can be selected only for Multi-directional cameras.

On the Users Administration page, press the [System] tab.

→[5.1 How to display](#)

→[5.2 How to operate](#)

Here, you can configure a priority stream that delivers images without reducing image quality or image update speed, even if multiple users have access to it at the same time.

- 13 [User mng.] to set authentication
 - 13.4 [IEEE 802.1X] to configure IEEE 802.1X
-

| User auth. | Host auth. | System | IEEE 802.1X | Data encryption |
|---------------------------|---------------------------------------------------------------|--------|-------------|-----------------|
| Priority stream | | | | |
| Activation | <input type="radio"/> On <input checked="" type="radio"/> Off | | | |
| Destination IP address(1) | <input type="text"/> | | | |
| Destination IP address(2) | <input type="text"/> | | | |
| Stream type | Stream(1) (H.265/2560x1920) | | | |
| Set | | | | |

Priority stream

[Activation]

On/Off determines whether to use priority stream delivery.



[Note:]

• If [Activation] is set to [On], the number of accessible users might be limited.

[Destination IP address(1)]

Enter the IP address of the first destination.

[Destination IP address(2)]

Enter the IP address of the second destination.



[Note:]

• [MULTI2U] Only [Destination IP address(1)] can be set.

[Stream type]

Select either [Stream(1)] or [Stream(2)].

[Stream (1)]: The stream (1) image is delivered.

[Stream (2)]: The stream (2) image is delivered.

13.4 [IEEE 802.1X] to configure IEEE 802.1X

On the Users Admin page, press [IEEE 802.1X]. Refer to the following how to display and operate

- 13 [User mng.] to set authentication
 - 13.4 [IEEE 802.1X] to configure IEEE 802.1X
-

the Advanced menu.

→5.1 [How to display](#)

→5.2 [How to operate](#)

Here, settings are made for IEEE 802.1X.

This function can be used to build a secure network environment using the authentication LAN switch. For authentication LAN switches, contact your network administrator. The procedure varies depending on the [EAP method]. Follow the procedure below. If [IEEE 802.1X] is [On], start the setting with [IEEE 802.1X] set to [Off].

| User auth. | Host auth. | IEEE 802.1X | Data encryption |
|-------------------------------------------------------------------------------------------------------------------------------------------------------------------------------------------------------------------------------------------------------------------------------------------------------------------------------------------------------------------------------------------------------------------------------------------------------------------------------------------------------------------------------------------------------------------|-------------------------------|--------------------------------------------------------------------------------------------------|------------------------------------------------------------------------------|
| IEEE 802.1X | | <input type="radio"/> On <input checked="" type="radio"/> Off | |
| User name | | <input type="text"/> | |
| Password | | <input type="password"/> | |
| Retype password | | <input type="password"/> | |
| CA Certificate | Certificate install | <input type="button" value="Choose File"/> No file chosen <input type="button" value="Execute"/> | |
| | Information | not installed | <input type="button" value="Confirm"/> <input type="button" value="Delete"/> |
| Private key or Client Certificate including private key | Installation | <input type="button" value="Choose File"/> No file chosen <input type="button" value="Execute"/> | |
| | Password (0 to 30 characters) | <input type="password"/> | |
| | Install status of private key | not installed | <input type="button" value="Delete"/> |
| Client Certificate | Installation | <input type="button" value="Choose File"/> No file chosen <input type="button" value="Execute"/> | |
| | Information | not installed | <input type="button" value="Confirm"/> <input type="button" value="Delete"/> |
| EAP method | | EAP-PEAP ▼ | |
| <small> User name and password are required for EAP-MD5 or EAP-PEAP. User name and installation of private key, client certificate and CA certificate are required for EAP-TLS. PEM(*.pem) or DER(*.der) format are supported for CA certificate. PEM(*.pem) or PFX(*.pfx) format is supported for client certificate and private key. Input password for private key when private key or certificate of PFX format is encrypted. Leave password blank when not encrypted. </small> | | | |
| <input type="button" value="Set"/> | | | |

[IEEE 802.1X]

Configure on/off whether to perform port authentication by IEEE 802.1X.

[User name]

Enter the user name that accesses the authentication LAN switch or the user name registered with the server.

Enter any username if it is not registered on the server.

Number of characters that can be entered: 1 to 32 characters

Characters that cannot be entered: Full-pitch and half-pitch alphanumeric characters " & ; ¥
 [Password] [Retype password]

Enter the password to access the authentication LAN switch.

Number of characters that can be entered: 4 to 32 characters

Characters that cannot be entered: Full-pitch and half-pitch alphanumeric characters " &
 [CA Certificate] - [Certificate install]

Install the root CA certificate. Do not include intermediate CA certificates.

Only when [IEEE 802.1X] is [Off] can you install it.

■ CA Certificate Specifications

| Item | Specifications | Remarks |
|-----------------------------------------------------------|--------------------------|----------------------|
| Data format | PEM format or DER format | Extension pem or der |
| Maximum number of certificates included in the PEM format | 1 piece | |
| Maximum certificate size | About 10 kB | |

[CA Certificate] - [Information]

Not installed: Have no certificates installed

[CA certificate host name]: Displayed when installed

[Expired]: Certificate expired

The [Execute] buttons enable you to view more information about CA certificates.

You can delete a CA certificate by using the [Delete] buttons.



[Note:]

- Verify that the CA certificate has not expired. If you use an expired certificate, you may not be able to connect to the authentication LAN switch.

[Private key or Client Certificate including private key]-[Installation]

Install a client certificate that contains a private key or private key.

Only when [IEEE 802.1X] is [Off] can you install it.

■ Specification of Client Certificate with Private Key or Private Key

| Item | Specifications | Remarks |
|-------------|--------------------------|----------------------|
| Data format | PEM format or PFX format | Extension pem or pfx |

- 13 [User mng.] to set authentication
 - 13.4 [IEEE 802.1X] to configure IEEE 802.1X
-

■ **Specification of Client Certificate with Private Key or Private Key** (*continued*)

| | | |
|-------------------------------------------------------------------|---------------------------------|--|
| Key length [bit] | 1024/ 1536/ 2048/ 3072/ 4096 | |
| Maximum number of certificates included in the PEM format | 6 pieces | |
| Maximum certificate size (including intermediate CA certificates) | About 10 kB | |

• **[Private key or Client Certificate including private key]** - **[Password(0 to 30 characters)]**

Enter the password if the private key is encrypted or if the password is set on a PFX client certificate. If it is not encrypted, leave it blank.

Number of characters that can be entered:0 to 30 characters

• **[Private key or Client Certificate including private key]** - **[Install status of private key]**

Not installed:If not installed

Installed:If installed

The [Delete] buttons allow you to delete private keys.

• **[Client Certificate] - [Installation]**

Install the client certificate.

If it is signed by an intermediate CA, install it with the intermediate CA certificate on the client certificate.

Only when [IEEE 802.1X] is [Off] can you install it.

■ **Client Certificate Specifications**

| Item | Specifications | Remarks |
|-------------------------------------------------------------------|----------------|---------------|
| Data format | PEM format | Extension pem |
| Maximum number of certificates included in the PEM format | 6 pieces | |
| Maximum certificate size (including intermediate CA certificates) | About 10 kB | |

[Client Certificate] - [Information]

Not installed:Have no certificates installed

[Host name of the certificate]:Displayed when installed

[Expired]: Certificate expired

The [Execute] buttons enable you to view more information about client certificates.

You can delete client certificates by using the [Delete] buttons.



[Note:]

- Make sure the client certificate has not expired. If you use an expired certificate, you may not be able to connect to the authentication LAN switch.

[EAP method]

Select the authentication method from [EAP-PEAP], and [EAP-TLS].

EAP-PEAP

- 1 Select [On] in [IEEE 802.1X].
- 2 Select [EAP-PEAP] in [EAP method].
- 3 Enter [User name] and [Password]/[Retype password] and press [Set].



[Note:]

- If you upgrade while [EAP-MD5] is set in [EAP method], the [EAP method] operates using [EAP-MD5]. Click the [Set] button to change [EAP method] to the selected EAP method.

EAP-TLS

- 1 In the [CA Certificate] [Certificate install], click the Select Files button, select the CA certificate, and then click the [Execute] button.
[Information] displays the host name (Common Name) you specified when creating certificates.
- 2 Click the File button on the Client Certificate that contains the private key or private key and select the client certificate that contains the private key or private key.
- 3 Enter [Password] if the private key is encrypted or if the password is set to a PFX-based client certificate. If it is not encrypted, leave it blank.
- 4 You install by clicking [Execute].
[Installed] is displayed on the [Install status of private key].
For Client Certificates containing private keys, the [Client Certificate] [Information] also displays [Installed].
- 5 If you installed a private key in step 2, click the Select Files button on the [Client Certificate], select the client certificate, and then click the [Execute] button.
[Information] displays the host name (Common Name) you specified when creating certificates.
- 6 Select [On] in [IEEE 802.1X] and select [EAP-TLS] in [EAP method].
- 7 Enter the user name registered with the server in [User name] and press [Set].

- 13 [User mng.] to set authentication
 - 13.4 [IEEE 802.1X] to configure IEEE 802.1X
-

Enter any username if it is not registered on the server.
 You do not need to enter [Password]/[Retype password].



[Note:]

- To delete individual certificates, set [IEEE 802.1X] to [Off].
- Confirm that the CA and client certificates have not expired. The port authentication feature may not be available if it is expired.

Example of [CA Certificate Confirmation] window

| CA Certificate - Confirm | | |
|--------------------------|---------------|---------------------|
| Common Name | IEEE 802.1X | |
| Country | JP | |
| State | Chiba | |
| Locality | Chiba | |
| Organization | iPro | |
| Organizational Unit | ***** | |
| CRT key | RSA key size | 2048bit |
| | Last modified | 2021/09/13 09:50:07 |

Close

[Client Certificate Confirmation Screen] example

| Client Certificate - Confirm | |
|------------------------------|---------------|
| Common Name | ca@IEEE802.1X |
| Country | JP |
| State | Chiba |
| Locality | |
| Organization | Panasonic |
| Organizational Unit | |

Close



[Important]

- If the camera cannot be accessed for some reason after the camera is set to [On] by [IEEE 802.1X], connect the camera to an unauthenticated switch or port. IEEE802.1X will be disabled and the camera will be accessible.

- If the client certificate contains an intermediate CA certificate, the client certificate must be first followed by the order of the intermediate CA certificate.
- When a certificate exceeding 10 kB is installed, no error is displayed during installation, but error may occur during connection.

13.5 [Data encryption] for setting up data encryption

On the Users Admin page, press [Data encryption]. Refer to the following how to display and operate the Advanced menu.

→5.1 [How to display](#)

→5.2 [How to operate](#)

Here, the data encryption settings are made.

The data encryption settings for each camera are described below.

PTZ camera, Fixed cameras

Click + on the left side of the setting screen to expand the item and display the detailed setting.

Click→ on the left of each expanded item to return to the previous window.

[Data encryption (Batch change)] Use [On]/[Off] to enable/disable encryption.

[On]: Enable data encryption. Encrypt all streams, all JPEG, and audio [AAC-LC].

[Off]: Disables data encryption.

[Stream], [JPEG]

[On] and [Off] individually configure whether to enable data encryption for each stream and each JPEG.

[Encryption password], [Retype encryption password]

Set the data encryption password.

Number of characters that can be entered: 4 to 16 characters

Characters that cannot be entered: Double-byte and single-byte symbols " &



[Important]

- When setting data encryption to [On], it is recommended that the total bit rate of the streams be set to 16 Mbps or less.
- When data encryption is set to [On], images cannot be viewed by browsers. To view the encrypted video, use our compatible equipment.
- Data-encrypted MP4 files and JPEG images cannot be viewed on the browser

playback page. Download to the PC and check with the decoding tool. For decoding tools, please refer to our technical information website<Control No. C0310>.



[Note:]

- If [Data encryption (Batch change)] is [On], the audio [AAC-LC] is encrypted ([G.726] [G.711] is not encrypted). To encrypt both video and audio, set [Data encryption (Batch change)] to [On] and set the audio [Audio input encoding format] to [AAC-LC].
- For encrypted MP4 files and JPEG images, the video can be viewed using a decoding tool.
- [New X Fixed-8MP][New X Fixed-6MP][New X Fixed-5MP] If [Image capture mode] is set to [60fps Mode] or [50fps Mode], [Encryption] of [Stream(2)] to [Stream(4)] and [JPEG(1)] [JPEG(2)] cannot be changed to [On].

Displaying pull-down menus when data encryption is enabled

For streams with data encryption enabled in both the [Live view] pull-down menu and the in-screen pull-down menu<Encrypted>The message is displayed.



[Note:]

- The [Multi-sensor + PTZ] is displayed only for Multi-directional + PTZ.

[Live view] pull-down menu on the live screen

- 13 [User mng.] to set authentication
 - 13.5 [Data encryption] for setting up data encryption
-

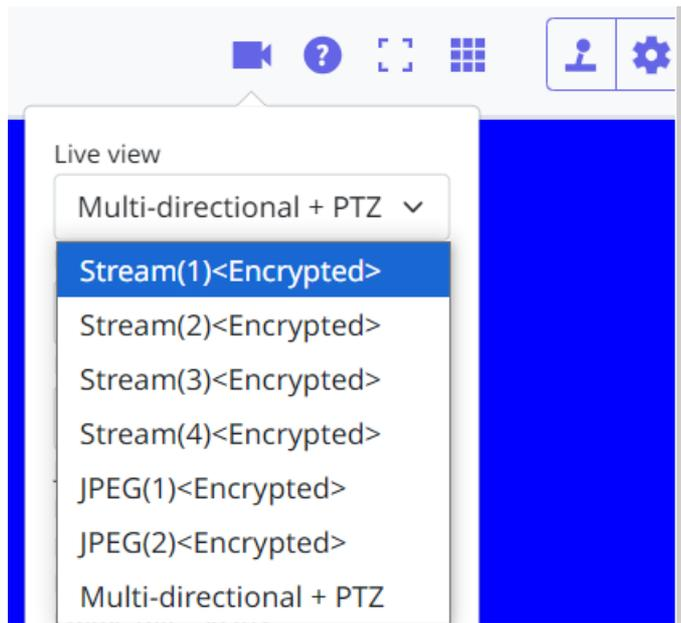

[Live view] pull-down menu in the setting window

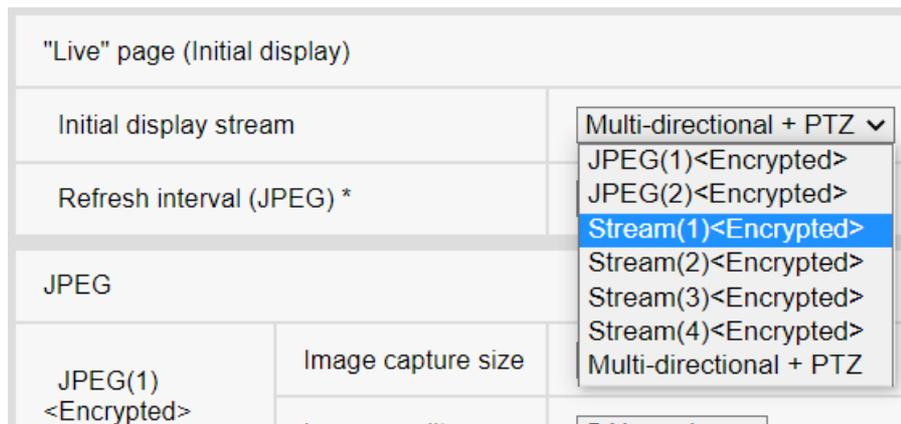

Multi-directional camera

Set the data encryption for each stream separately.

| User auth. | Host auth. | System | IEEE 802.1X | Data encryption |
|---------------------------------------------------------------------------------------------------------------------------------------------|----------------------------------------|---------------------------|-------------|-----------------|
| Data encryption | | | | |
| Stream(1) | <input checked="" type="radio"/> On | <input type="radio"/> Off | | |
| Stream(2) | <input checked="" type="radio"/> On | <input type="radio"/> Off | | |
| Encryption password | <input type="password" value="....."/> | | | |
| Retype encryption password | <input type="password" value="....."/> | | | |
| If encryption is set, the recorded video data will also be encrypted. Data encryption is available only for the stream(1) and stream(2). | | | | |
| Set | | | | |

[Stream]

Enable/disable data encryption for each stream separately.

[Encryption password], [Retype encryption password]

Set the data encryption password.

Number of characters that can be entered:4~16

Characters that cannot be entered:Double-byte and single-byte symbols&



[Important]

- JPEG cannot encrypt data.
- When setting data encryption to [On], it is recommended that the total bit rate of the streams be set to 64 Mbps or less.
- The data-encrypted MP4 file cannot be viewed on the browser playback page. Download to the PC and check with the decoding tool. For decoding tools, please refer to our technical information website<Control No. C0310>.
→[2.8 Play back images on the SD Memory Card](#)



[Note:]

- When the [Data encryption] of all streams is set to [On], the audio [AAC-LC] is encrypted ([G.726] [G.711] is not encrypted). If [AAC-LC] is selected in [Audio input encoding format], the sound will not be played while JPEG is displayed in live picture.
- For encrypted MP4 files, the video can be viewed using the decryption tool.

Displaying pull-down menus when data encryption is enabled

For streams with data encryption enabled in the [Live view] pull-down menu<Encrypted>The

- 13 [User mng.] to set authentication
 - 13.5 [Data encryption] for setting up data encryption
-

message is displayed. Also, in the pull-down menu in the setting screen, streams with valid data encryption are displayed in <>.

[Live view] pull-down menu on the live screen

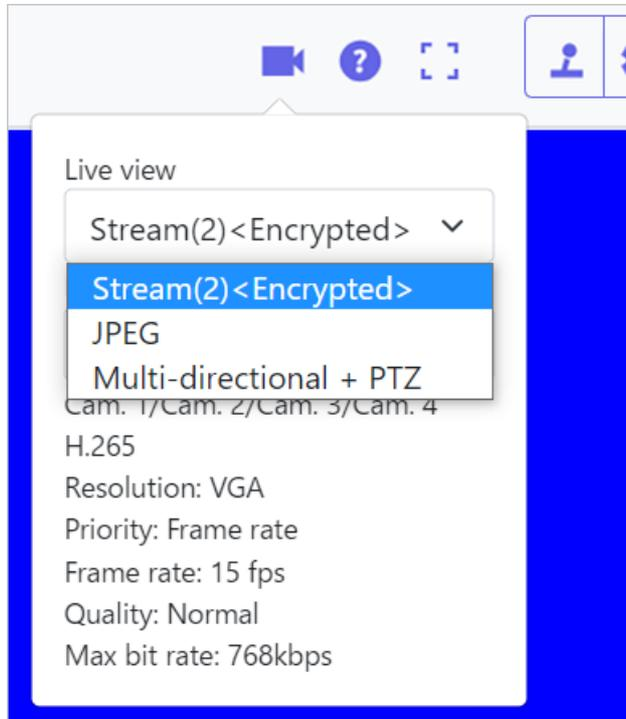

[Live view] pull-down menu in the setting window

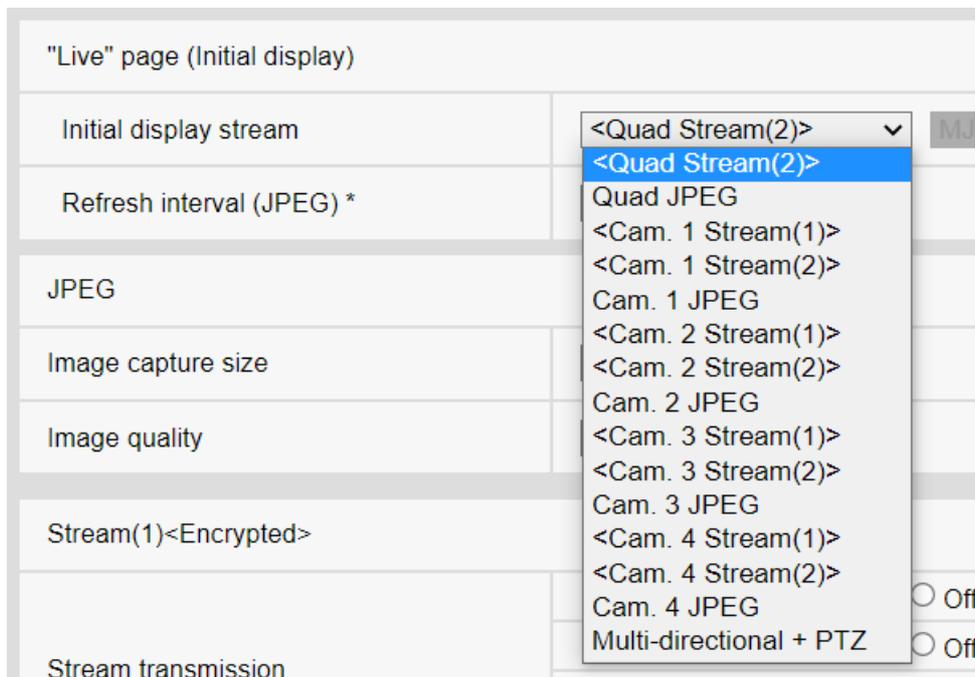

13 [User mng.] to set authentication

13.6 [Security] to configure security

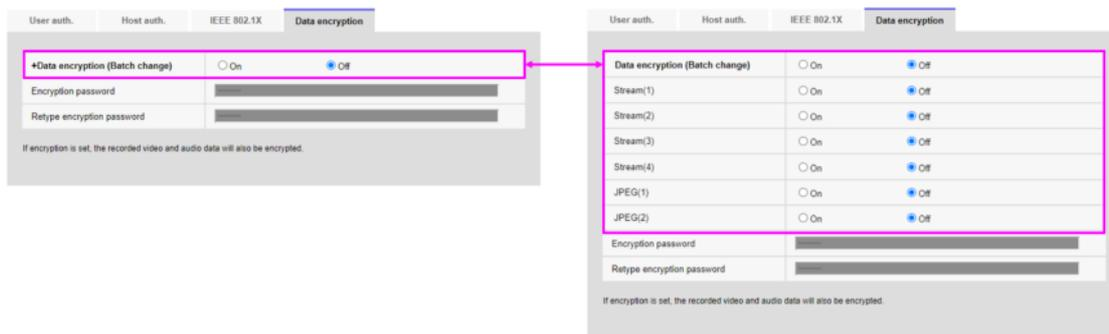

13.6 [Security] to configure security

On the Users Admin page, press [Data encryption]. Refer to the following how to display and operate the Advanced menu.

→5.1 [How to display](#)

→5.2 [How to operate](#)

Here, the data encryption settings are made.

Brute force attack countermeasures

Configure settings related to brute force attack countermeasures.

If you enter the wrong user name or password the specified number of times and within the time set in [Blocking conditions], you cannot access your browser or SNMP/FTP for the period set in [Blocking period].

For example, when using the settings on the screen shown above ([Browser access blocking period]: 30s, [Browser access blocking conditions] (times): 5 times, [Browser access blocking conditions] (s): 10s), if your login attempt fails 5 times within 10 seconds, the login page will not be displayed for 30 seconds.

Browser access blocking period (s)

Set the length of time the browser cannot be accessed.

Input range: 10 to 1000(s)

Browser access blocking conditions – Input range (times)

Set the conditions (number of failed attempts) before access to the browser is prohibited.

Input range: 1 to 5 (times)

Browser access blocking conditions – Input range (s)

Set the conditions (specified length of time) before access to the browser is prohibited.

Input range: 1 to 100 (s)

SNMP/FTP access blocking period (s)

Set the length of time the SNMP/FTP cannot be accessed.

Input range: 10 to 1000(s)

SNMP/FTP access blocking conditions – Input range (times)

Set the conditions (number of failed attempts) before access to the SNMP/FTP is prohibited.

Input range: 1 to 5 (times)

SNMP/FTP access blocking conditions – Input range (s)

Set the conditions (specified length of time) before access to the SNMP/FTP is prohibited.

Input range: 1 to 100(s)



[Note:]

- If you want to use the browser access blocking function in [Brute force attack countermeasures], set [User auth.] to [On] on the [User auth.] tab.

Browser Access

Set whether or not to enable/disable browser access.



[IMPORTANT]

- If [Browser Access] is set to [Disable], access to live images is disabled.
- To switch [Browser Access] from [Disable] to [Enable], you need to initialize the setting data.

Refer to the camera's Operating Instructions for details on initializing the settings.

14 Networking configuration [Network]

Network pages configure network settings.

Network pages consist of the [Network] tab and the [Advanced] tab.



[Note:]

- The items that can be set differ depending on the function of the model.
- Refer to the catalog specifications for the functions installed in each model.

14.1 Networking [Network]

On the Network Page, press the [Network] tab. Refer to the following how to display and operate the Advanced menu.

→[5.1 How to display](#)

→[5.2 How to operate](#)

The following information is required to configure the network.

Check with your network administrator or Internet service provider.

- IP address
- Subnet Mask
- Default Gateway (with Gateway Server Router)
- HTTP port
- Primary server address for DNS, secondary server address (when DNS is used)



[Note:]

- Contact your network administrator for the address settings for each server.
- To connect a camera to a router and access the camera via the Internet, you must configure a separate HTTP port number for each network camera, and use the router's port forwarding features to translate addresses. For details, refer to your router's instruction manual.
- Port forwarding functions are used to convert global IP addresses to private IP addresses, such as Static IP Mascalade and Network Address Translation (NAT). This feature is configured on the router.

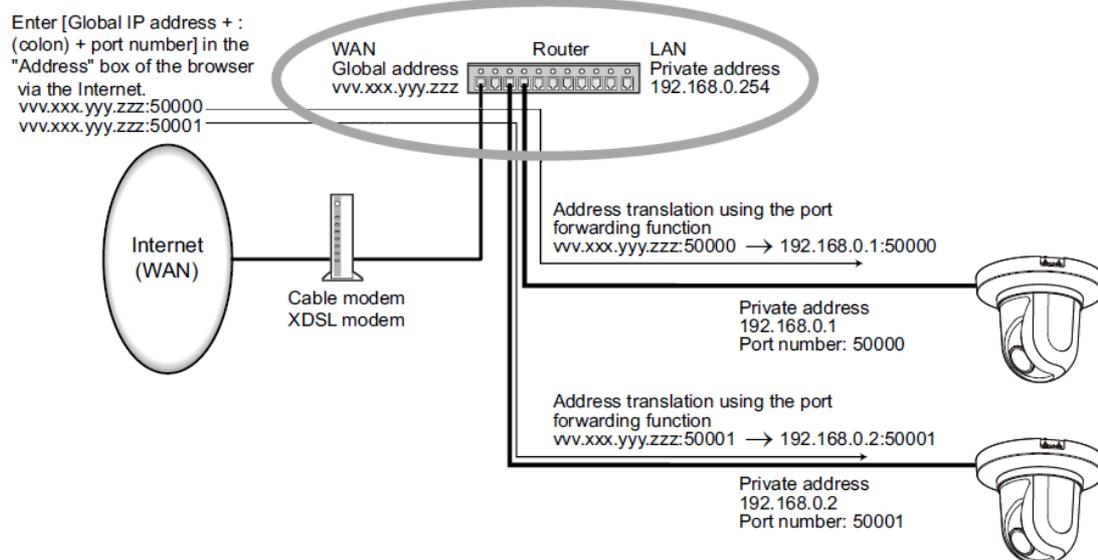

IPv4 network

[Network Settings]

Select how to set the IP address.

[Static]: Enter the IP address into the [IP address(IPv4)] to set the IP address.

[DHCP]: Set the IP address using the DHCP function. If you cannot obtain an IP address from the DHCP server, set the IP address to 192.168.0.10. Subsequently, if you obtain an IP address from a DHCP server, you change it to the IP address.

[Auto(AutoIP)]: Set the IP address using the DHCP function. If the DHCP server is not found, the IP address is automatically configured.

[Auto(Advanced)]: Using the DHCP function, refer to the network address information and set the unused IP address to the camera as the fixed IP address. The camera automatically determines the set IP address within the range of the subnet mask. If the DHCP server is not found, set the IP address to 192.168.0.10.



[Note:]

- If the IP address cannot be retrieved from the DHCP server in AutoIP, search for the IP address that is not used in the same network between 169.254.1.0 and 169.254.254.255 and set the IP address.
- [MULTI_PTZ] In DHCP/Auto setting (Omakase), if the DHCP server is not found, set the IP address of the PTZ camera to 192.168.0.10 and the IP address of the Multi-directional camera to 192.168.0.11.

[IP address(IPv4)]

When the DHCP function is not used, enter the IP address of the computer. Do not overlap with

the IP address set on the PC or other network camera.



[Note:]

- Multiple IP addresses are not available even when the DHCP function is used. Contact your network administrator for the DHCP server configuration.

[Subnet mask]

When the DHCP function is not used, enter the subnet mask of the computer.

[Default gateway]

If you do not use the DHCP function, enter the default gateway for your computer.



[Note:]

- Multiple IP addresses are not available for the default gateway, even if you use the DHCP facility. Contact your network administrator for the DHCP server configuration.

[DNS]

Specify whether the DNS server addresses are automatically acquired ([Auto]) or manually entered ([Manual]).

When set to [Manual], you need to configure the DNS server IP addresses.

If you use the DHCP function, you can automatically obtain the DNS server address by setting it to [Auto].

Contact your system administrator for the setting.

[Primary server address], [Secondary server address]

If you use [DNS] with [Manual], enter the IP address of the DNS server.

Contact your system administrator for the IP address of the DNS server.

IPv6 network



[Important]

- When IPv6 is accessed, the stream image cannot be displayed on the live screen. If you want to display the stream image on the live screen, please access it via IPv4.

[Manual]

Configure [On] and [Off] to manually configure IPv6 addresses.

[On]:Manually enter the IPv6 address.

[Off]:IPv6 address cannot be entered manually.

[IP address(IPv6)]

If [Manual] is set to [On], IPv6 addresses must be entered manually.

Enter to avoid duplication with other devices.



[Note:]

- When connecting over a router with a manually configured IP address, enable the automatic configuration feature for IPv6 addresses using IPv6-compatible routers. Configure an IPv6 address that contains prefix information provided by IPv6-compatible routers. For details, refer to your router's instruction manual.

[Default gateway]

Enter the default gateway for the IPv6 network when the IPv6 network [Manual] is [On].

[DHCPv6]

You can configure [On]/[Off] to use the IPv6 DHCP feature.

Configure the DHCP server so that the PC and other network cameras that do not use the DHCP function do not have the same IP address. Contact your network administrator for server configuration.

[Primary DNS server address], [Secondary DNS server address]

Enter the IPv6 address of the DNS server. Contact your system administrator for the IPv6 address of the DNS server.

Common

[HTTP port]

Assign individual port numbers.

Configurable port number:1~65535

The following port numbers cannot be set because they are used by this computer.

20、21、22、23、25、42、53、67、68、69、80、110、123、161、162、443、554、995、1883、8883、10669、10670、59000~61000



[Note:]

- Some ports may not be accessed by some browsers. If access is lost, use HTTPS or the i-PRO Setup Tool (iCT) to change the port number.
- [MULTI] The port numbers 32768 to 49151 cannot be set.

[Line speed]

Select the data communication speed from the following. Normally, it is recommended to use the default [Auto].

[Auto]:The communication speed is set automatically.

[100 M-Full]:100 Mbps full duplex

[100 M-Half]:100 Mbps half duplex

[10 M-Full]:10 Mbps full duplex

[10 M-Half]:10 Mbps half duplex

[Max RTP packet size]

Set whether to limit the size of RTP packets sent from the camera when viewing camera images using RTP. Normally, it is recommended to use the [1,500 bytes] option.

If the packet size of the communication line is limited, select [Restricted (1280 bytes)]. Contact the network administrator for the maximum packet size of the communication line.

[HTTP max segment size(MSS)]

Set whether to limit the maximum segment size (MSS) sent from the camera when viewing the camera image using HTTP. Usually, it is recommended to use the default settings.

If the maximum segment size (MSS) of the communication line to be used is limited, select [1024 Byte]/[Restricted (1280 Byte)]. Contact your network administrator for the maximum segment size (MSS) of the communication line.

[Bandwidth control(bit rate)]

Select the amount of data delivered from the following.

[MULTI4][MULTI3][MULTI2S]

[Unlimited]/4096kbps/ 6144kbps/ 8192kbps/ 10240kbps/ 12288kbps/ 15360kbps/ 20480kbps/
25600kbps/ 30720kbps/ 35840kbps/ 40960kbps/ 51200kbps/ 61440kbps/ 81920kbps/
102400kbps/ 153600kbps

[PTZ][CompactX][CompactS][New X Fixed]

[Unlimited]/64kbps/ 128kbps/ 256kbps/ 384kbps/ 512kbps/ 768kbps/ 1024kbps/ 2048kbps/
4096kbps/ 6144kbps/ 8192kbps/ 10240kbps/ 15360kbps/ 20480kbps/ 25600kbps/ 30720kbps/
35840kbps/ 40960kbps/ 51200kbps

[MULTI2U]

[Unlimited]/128kbps/ 256kbps/ 384kbps/ 512kbps/ 768kbps/ 1024kbps/ 2048kbps/ 4096kbps/
6144kbps/ 8192kbps/ 10240kbps/ 15360kbps/ 20480kbps/ 25600kbps/ 30720kbps/ 35840kbps/
40960kbps/ 51200kbps/ 61440kbps



[Note:]

- Refer to the catalog specifications for the functions installed in each model.
- If [64 kbps] is selected, set the [Audio transmission mode] on the [Audio] tab to [Off].
→9.5 [\[Audio\] for setting sound](#)
- If [Bandwidth control(bit rate)] is set low, the snapshot button may not work depending on the operating environment. If so, select [JPEG] on the live page and run the snapshot with the smallest resolution delivered.

- [MULTI] When playing back images stored on the SD Memory Card, the [Bandwidth control(bit rate)] must be set to [Unlimited] or above [51200 kbps].

[Easy IP Setup accommodate period]

Set the time to enable Network Settings from IP-based Simple Configuration Software to either [20min] or [Unlimited] after the computer starts.

[20 minutes]:The camera setting operation using the IP easy setting software is enabled only for 20 minutes after starting the machine.

[Unlimited]:The camera setting operation in the IP easy setting software is always enabled.



[Note:]

- Camera display with the IP easy setting software is always enabled and the camera screen can be opened.

[FTP access to camera]

Use [Allow] or [Forbid] to set whether or not to allow FTP access to the cameras.

[Permission]:Allow FTP access to the camera.

[Prohibition]:FTP access to the camera is prohibited.



[Important]

- If you allow FTP access to the camera, there is a possibility that authentication information (user names, passwords, etc.) will be leaked when accessing the camera from a PC.

[ONVIF®]

Use [On]/[Off] to set whether to use the ONVIF function.

[Enable]:You can use the ONVIF function.

[Disabled]:The ONVIF function cannot be used.

14.2 [Advanced] for advanced networking settings

On the Network Page, press the [Advanced] tab. Refer to the following how to display and operate the Advanced menu.

→5.1 [How to display](#)

→5.2 [How to operate](#)

Here, the SMTP (mail), FTP/SFTP, NTP, UPnP, HTTPS, DDNS, SNMP, QoS, SRTP, MQTT,

and LLDP functions are set.

Click the link to each item to navigate to each setting page.



14.2.1 Set mail sending



[Note:]

- The items that can be set differ depending on the function of the model.
- Refer to the catalog specifications for the functions installed in each model.

[E-mail notification]

On/Off is used to specify whether to send mail in the following cases.

When an alarm is activated (e-mail to [Alarm] field)

When notifying the remaining capacity of the SD Memory Card (mail notifying destination: [Diag.] field)

When the free space of the SD Memory Card is insufficient (mail to send message to: [Diag.] field)

SD Memory Card recognition errors (mail notification destination: [Diag.] field)

When writing to SD Memory Card is failed (unique alarm notification destination: [Diag.] field)

[Alarm image attachment]

On/Off sets whether or not to attach images when sending mail by alarm detection.



[Note:]

- [New X Fixed-8MP][New X Fixed-6MP][New X Fixed-5MP][Alarm image attachment] is not available when [Image capture mode] is set to [60fps Mode] or [50fps Mode].

[Image capture size]

Select the resolution of the image to be attached to the alarm mail from the following.

JPEG(1)/ JPEG(2)

[SMTP server address]

Enter the IP address or host name of the SMTP server to send e-mail.

Number of characters that can be entered: 1 to 128 characters

Input Characters: One-byte alphanumeric and one-byte symbols : . _ -

[SMTP port]

Enter the port number to send mail.

Configurable port number:1~65535

The following port numbers cannot be set because they are used by this computer.

20、21、22、23、42、53、67、68、69、80、110、123、161、162、443、554、995、1883、
8883、10669、10670、59000~61000

[POP server address]

If you selected [POP before SMTP] in [Type], enter the IP address or hostname of the POP server.

Number of characters that can be entered:1 to 128 characters

Input Characters:One-byte alphanumeric and one-byte symbols : . _ -



[Important]

•To enter a hostname for [SMTP server address] [POP server address], you must configure the DNS on the [Network] tab of the network page.

→[14.1 Networking \[Network\]](#)

•[MULTI] The port numbers 32768 to 49151 cannot be set.

Authentication-Type

Select the authentication method for sending mail from the list below.

None:Without authentication

POP before SMTP:Prior to sending e-mail, authenticate the POP server that receives the e-mail.

SMTP:Authenticate the SMTP server.



[Note:]

•If you do not know how to authenticate e-mail, contact your network administrator.

Authentication-User Name

Enter the username that you want to access the server.

Number of characters that can be entered:0 to 32 characters

Characters that cannot be entered:Double-byte and single-byte symbols " & ; ; ¥

Authentication-Password

Enter the password to access the server.

Number of characters that can be entered:0 to 128 characters

Characters that cannot be entered:Double-byte and single-byte symbols " &

[Sender's E-mail address]

Enter the sender's mail address.

The entered mail address is displayed in the From field of the received mail.

Number of characters that can be entered:3 to 128 characters

Input Characters:Half-pitch alphanumeric and half-pitch symbols @ . _ -
[SSL]

When sending [Alarm Notification] or [Diag.] mail notification in SSL-encrypted format, set it to [On]. When set to [On], the authentication method is set to [SMTP]. Configure the [User name] and [Password] for authentication.



[Note:]

- Some SMTP servers may not support SSL.
- The SMTP over SSL method is supported. STARTTLS is not supported.
- If set to [On], you might need to set the SMTP port number to 465. Check with your provider for details.

[Address 1] through [Address 4]

Set the mail address of the notification destination. You can set up to 4 notification destinations.

Number of characters that can be entered:3 to 128 characters

Input Characters:Half-pitch alphanumeric and half-pitch symbols @ . _ -

To delete a set e-mail address, press [Delete] for the e-mail address to delete.

[Terminal 1]:Mail is notified when an alarm is generated at terminal 1.

[Terminal 2]:Mail is notified when an alarm is generated at terminal 2.

[Terminal 3]:Mail is notified when an alarm is generated at terminal 3.

[VMD]:Mail is notified when operation is detected.

[SCD]:Notifies by e-mail when undesired detection occurs.

[Command Alarm]:Mail notification is executed when a command alarm is entered.

[Audio detection]:Mail is notified when sound is detected.

[Impact detection]:Mail is notified when impact detection is detected.

[Casing open detection]:Mail is notified when opening detection is detected.

[Diag.]:

-SD Memory Card Remaining capacity notification

-SD Memory Card with insufficient free space

-SD Memory Card recognition error

[Auto track]:Mail is notified when an automatic tracking alarm is generated.



[Note:]

- Message recipient The diagnostic mail notified when the [Diag.] field is checked does not reflect the [E-mail subject] and [E-mail body] settings set below.

[E-mail subject(Alarm)]

Enter the subject of the alarm mail.

Number of characters that can be entered:0 to 50 characters

Use the camera title:The camera title is displayed in the mail subject line.

Cause of alarm:Add an alarm factor to the email subject.

[E-mail subject(Diag.)]

Enter the subject of the diagnosis mail.

Number of characters that can be entered:0 to 50 characters

Use the camera title:The camera title is displayed in the mail subject line.

[E-mail body(Alarm)]

Enter the body of the alarm message.

Number of characters that can be entered:0 to 200 characters

Cause of alarm:The alarm cause %p% is added to the message body. The %p% is sent in place of the cause of the alarm.

For operation detection alarm: "VMD"

For undesired detection alarm: "SCD"

For auto-tracking alarm: "AT"

For intrusion alarm by AI-VMD: "INT"

For residence alarm by AI-VMD: "LOI"

For direction alarm by AI-VMD: "DIR"

For line cross alarm by AI-VMD: CLD

For the terminal alarm: The terminal names set in [Terminal 1], [Terminal 2], and [Terminal 3] of the [Terminal name]. (For example, if the name of terminal 1 is [Terminal 1], "Terminal 1")

For command alarm: "CMD"

In the case of the sound detection alarm (AI sound identification target: gunshot): "Audio detection gunshot"

In the case of the sound detection alarm (AI sound identification target: screaming): "Audio detection yell"

In the case of the sound detection alarm (AI sound identification target: horn): "Audio detection Vehicle Horn"

In the case of the sound detection alarm (AI sound identification target: cracking of glass): "Audio

detection Glass break”

In the case of sound detection alarm (AI sound identification target: Others): “Audio detection”

For impact detection alarm: “Impact detection”

For opening detection alarm:

When the detection operation is [Alarm notification when the front cover both opening and closing]:

If the camera front cover has been opened: “Casing open detection Open”

If the camera front cover is closed: “Casing open detection Close”

When the detection operation is [Alarm notification continue while the front cover is open]:

If the camera front cover has been opened: “Casing open detection Open”



[Note:]

• [MULTI] In the case of an operation detection alarm and disturbance detection alarm, information to identify the camera is given by the detected camera.

For the operation detection alarm of camera 1: “VMD(CH1)”

For the operation detection alarm of camera 2: “VMD(CH2)”

For the operation detection alarm of camera 3: “VMD(CH3)”

For the operation detection alarm of camera 4: “VMD(CH4)”

For undesired detection alarm of camera 1: “SCD (CH1)”

For undesired detection alarm of camera 2: “SCD(CH2)”

For the disturbance detection alarm of camera 3: “SCD(CH3)”

For the disturbance detection alarm of camera 4: “SCD(CH4)”

Occurrence time: The occurrence time %t% is added to the message text. The %t% is replaced by the time the alarm occurred (hour: minute: second).



[Note:]

• If the SD Memory Card has no free space, [SD Memory Card is FULL] or [SD Memory Card cannot be recognized] is sent.

• By describing the substitute characters in the message text, the cause type and the time of alarm can be automatically assigned.

Alternate character alarm factor: %p%, occurrence time: %t%

(Example of Use)

When the operation detection alarm is generated at 19:13:24 after setting the following character string in the mail body.

Set mail text: %p%alarm occurred at %t%.

Message text: [“VMD” alarm was generated at 19:13:24].

If the body is blank, the email languages that are sent are determined by the [Menu language] of the [Basic].

Specifying [Japanese] sends e-mail in Japanese or in other languages.

[Terminal 1 (Up to 10 characters)]

Enter the name of Terminal 1 used for alarm factors in the mail body.

Characters that cannot be entered:Single-byte characters " &

[Terminal 2 (Up to 10 characters)]

Enter the name of terminal 2 used for alarm factors in the mail body.

Characters that cannot be entered:Single-byte characters " &

[Terminal 3 (Up to 10 characters)]

Enter the name of terminal 3 used for alarm cause in the mail body.

Characters that cannot be entered:Single-byte characters " &

Mail notification example

Mail format when checkbox for camera title is specified in mail subject and check box for alarm factor/occurrence time is specified in mail body

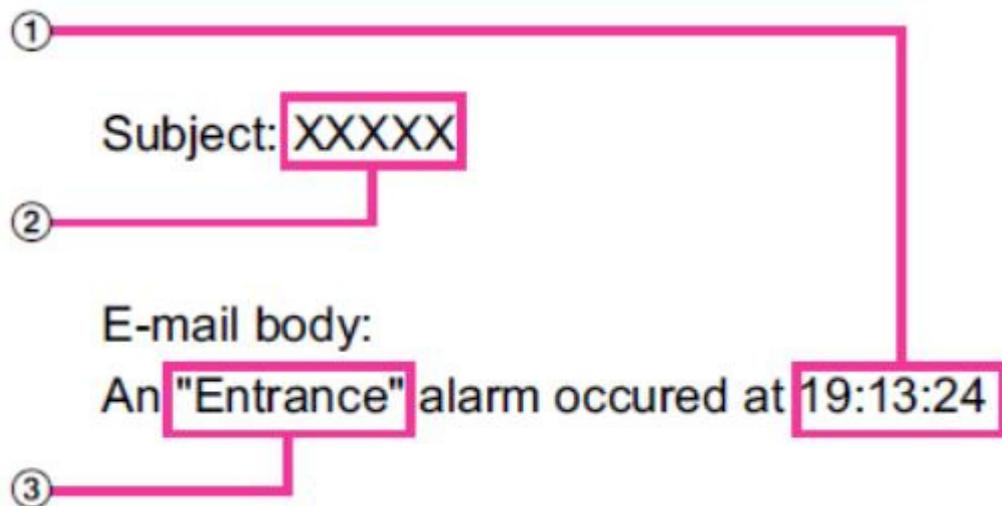

- ① The alarm time is assigned.
- ② The camera title is used for the e-mail subject.
- ③ The name specified by terminal names 1 to 3, which are alarm factors, is given.

14.2.2 Configuring FTP/SFTP transmission function

FTP (File Transfer Protocol) and SFTP (SSH File Transfer Protocol) are file transfer protocols used to send images to servers.

SFTP can safely send images to the server using an SSH (Secure Shell) encrypted data stream.
The following two transmission functions are available.

- Image sent when alarm is generated
- Transmit images periodically



[Note:]

- The factors displayed differ depending on the function of the model.
- Refer to the catalog specifications for the functions installed in each model.

14 Networking configuration [Network]
 14.2 [Advanced] for advanced networking settings

| Network | | Advanced | |
|------------------------------------------------------------------------------------------------------------------------------------------------------------------------------------------------------------------------------------------------|------------------------------------------------------------------------------------------------------------------------------------------------------------------------------------------------------------------------------------------------------------------------------------------------------------------------------------------------------------------------------------------------------------------------------------------------|--------------------------|--------------------|
| SMTP(E-mail) FTP/SFTP NTP UPnP HTTPS DDNS SNMP QoS SRTP MQTT | | | |
| Transmission protocol | <input type="radio"/> FTP <input checked="" type="radio"/> SFTP | | |
| Alarm setting (Server 1) | | | |
| Alarm image transmission | <input type="radio"/> On <input checked="" type="radio"/> Off | | |
| Directory name | <input type="text"/> | | |
| File name | <input type="checkbox"/> Terminal 1 <input type="checkbox"/> Terminal 2 <input type="checkbox"/> Terminal 3 <input type="checkbox"/> VMD <input type="checkbox"/> SCD <input type="checkbox"/> Auto track <input type="checkbox"/> Command alarm <input type="checkbox"/> Audio detection <small>* For alarms by the "Ext. software", alarm images will be transmitted only by configuring the alarm image SFTP transmission.</small> | | |
| FTP transmission retry | <input type="radio"/> On <input type="radio"/> Off | | |
| Pre alarm | Transmission interval | Maximum number of images | Recording duration |
| Post alarm | Transmission interval | Number of images | Recording duration |
| Image capture size | <input type="text"/> | | |
| Alarm setting (Server 2) | | | |
| Alarm image transmission | <input type="radio"/> On <input checked="" type="radio"/> Off | | |
| Directory name | <input type="text"/> | | |
| File name | <input type="checkbox"/> Terminal 1 <input type="checkbox"/> Terminal 2 <input type="checkbox"/> Terminal 3 | | |
| <small>[FTP transmission retry] [Pre alarm] [Post alarm] [Image capture size] is the same as the [Alarm setting (Server 1)].</small> | | | |
| Periodic transmission settings | | | |
| Periodic image transmission | <input type="radio"/> On <input type="radio"/> Off | | |
| Directory name | <input type="text"/> | | |
| File name | <input type="radio"/> Name w/time&date <input type="radio"/> Name w/o time&date | | |
| Transmission interval | <input type="text" value="1s"/> | | |
| Image capture size | <input type="text" value="JPEG(1)"/> | | |
| <small>[Periodic image transmission] is available for [FTP Server 1], [SFTP Server 1].</small> | | | |
| SFTP server 1 settings | | | |
| SFTP server address | <input type="text"/> <small>Example of entry: 192.168.0.10</small> | | |
| Port number | <input type="text"/> <small>(1-65535)</small> | | |
| Host key hash | <input type="text"/> SHA256 <small>Example of entry: dqVcdVZ/2ySO5tz/R6YR+rbW6dnap6P743uIMV0cf0</small> | | |
| User name | <input type="text"/> | | |
| Password | <input type="password"/> | | |
| FTP Server 1 setting | | | |
| FTP server address | <input type="text"/> <small>Example of entry: 192.168.0.10</small> | | |
| User name | <input type="text"/> | | |
| Password | <input type="password"/> | | |
| Control port | <input type="text"/> <small>(1-65535)</small> | | |
| FTP mode | <input type="radio"/> Passive <input type="radio"/> Active | | |
| SFTP server 2 settings | | | |
| SFTP server address | <input type="text"/> <small>Example of entry: 192.168.0.10</small> | | |
| Port number | <input type="text"/> <small>(1-65535)</small> | | |
| Host key hash | <input type="text"/> SHA256 <small>Example of entry: dqVcdVZ/2ySO5tz/R6YR+rbW6dnap6P743uIMV0cf0</small> | | |
| User name | <input type="text"/> | | |
| Password | <input type="password"/> | | |
| FTP server 2 settings | | | |
| FTP server address | <input type="text"/> <small>Example of entry: 192.168.0.10</small> | | |
| User name | <input type="text"/> | | |
| Password | <input type="password"/> | | |
| Control port | <input type="text"/> <small>(1-65535)</small> | | |
| FTP mode | <input type="radio"/> Passive <input type="radio"/> Active | | |
| <input type="button" value="Set"/> | | | |

[Transmission protocol]

Configure the protocol with the destination server by selecting it from FTP/SFTP.

SFTP:Use SFTP as the protocol for communicating with the server.

FTP:Use FTP as the protocol to communicate with the server.



[Important]

- If FTP is selected in the protocol setting, FTP server authentication information (user name, password) may be leaked on the network when sending images to the FTP server. Use of SFTP is recommended.

Alarm settingFixed

Alarm setting (server 1)

[Alarm image transmission]

Select [On] or [Off] to determine whether or not to transmit images when an alarm is detected.

[On]:Transmits an image to the server when an alarm has occurred.

[Off]:Does not transmit an image to the server when an alarm has occurred.



[Note:]

- [New X Fixed-8MP][New X Fixed-6MP][New X Fixed-5MP][Alarm image transmission] is not available when [Image capture mode] is set to [60fps Mode] or [50fps Mode].

[Directory name]

Enter the directory name where the alarm images are to be saved.

For example, enter [/ALARM] to designate the directory [ALARM] under the root directory of the server.

Number of characters that can be entered:1 to 256 characters

Characters that cannot be entered:Double-byte and single-byte symbols " & ;

[File name]

Enter the file name used for the alarm image to be transmitted to the server. The file name will be as follows.

File name:File name entered + Date and time (year, month, day, minute, second) + Sequence number

Number of characters that can be entered:1 to 32 characters

Characters that cannot be entered:Double-byte and single-byte symbols " & * / : ; < > ? ¥ |

When [On] is selected for [Alarm image FTP transmission], you can select the alarm type from the following.

[Terminal 1]:Transmit the image to the server when an alarm occurs in Terminal 1.

- [Terminal 2]: Transmit the image to the server when an alarm occurs in Terminal 2.
[Terminal 3]: Transmit the image to the server when an alarm occurs in Terminal 3.
[VMD]: Transmit the image to the server when motion is detected.
[SCD]: Transmit the image to the server when SCD (scene change detection) occurs.
[Auto track]: Transmit the image to the server when an auto track occurs.
[Audio detection]: Transmit the image to the server when audio detection occurs.
[Impact detection]: Transmit the image to the server when impact detection occurs.
[Casing open detection]: Transmit the image to the server when opening detection occurs.
[Command alarm]: Transmit the image to the server when a command alarm is entered.



[Note:]

- The items that can be set differ depending on the function of the model.
- Refer to the catalog specifications for the functions installed in each model.

[FTP transmission retry]

Select [On] or [Off] to determine whether or not to resend failed FTP transmissions.

[On]: If transmission fails, transmissions are resent until they are successfully sent.

[Off]: If transmission fails, the image that failed to be sent is discarded and the next image is sent.



[Note:]

- When SFTP is selected in [Transmission protocol] settings, FTP transmission retry is unavailable.
- When 2fps or 3fps is selected in [Refresh interval], FTP transmission retry is unavailable.

[Pre alarm]

[Transmission interval]

Select the transmission interval of images before an alarm occurs from the following.

When 60fps mode, 30fps mode or 15fps mode is selected for [Image capture mode]:

0.1fps/ 0.2fps/ 0.33fps/ 0.5fps/ 1fps/ 2fps/ 3fps

When 50fps mode, 25fps mode or 12.5fps mode is selected for [Image capture mode]:

0.08fps/ 0.17fps/ 0.28fps/ 0.42fps/ 1fps/ 2.1fps/ 3.1fps

[Maximum number of images]

Select the number of images to be transmitted from the following.

[0 pic]/[1 pic]/[2 pics]/[3 pics]/[4 pics]/[5 pics]/[6 *]/[7 *]/[8 *]/[9 *]/[10 *]/[20 *]/[30 *]/[40 *]/[50 *]

[Recording duration]

Approximate time to be taken to save the set [Maximum number of images] with the set [Transmission interval] will be displayed.



[Note:]

- When [JPEG(1)] is selected for the capture size of the image to be transmitted, pre alarm is unavailable if the image capture size of [JPEG(1)] is larger than [1920x1080].
- When “On” is selected for [Image compression rate upon alarm detection], only post alarm recorded images are compressed. Compression is not applied to pre alarm recorded images.
- When a selection with an asterisk (*) on the right of it is selected for [Maximum number of images] of [Pre alarm], the specified number of images may not be able to be sent depending on the image capture size and image quality. The following table shows the maximum number of images that can be sent for pre alarm.
- If the refresh interval is higher than 1fps, the maximum number of pre-alarm images is 10.

| | | Image quality | | | | | | | | | |
|--------------------|------------|---------------|----|----|----|----|----|----|----|----|----|
| | | 0 | 1 | 2 | 3 | 4 | 5 | 6 | 7 | 8 | 9 |
| Image capture size | 1920 x1080 | 9 | 9 | 9 | 9 | 10 | 10 | 10 | 20 | 30 | 40 |
| | 1280 x960 | 5 | 6 | 7 | 8 | 10 | 10 | 10 | 20 | 30 | 40 |
| | 1280 x720 | 7 | 8 | 10 | 10 | 10 | 20 | 20 | 30 | 40 | 50 |
| | VGA | 10 | 20 | 20 | 30 | 30 | 40 | 50 | 50 | 40 | 50 |
| | 640x360 | 20 | 30 | 40 | 50 | 50 | 50 | 50 | 50 | 50 | 50 |
| | QVGA | 40 | 50 | 50 | 50 | 50 | 50 | 50 | 50 | 50 | 50 |
| | 320x180 | 50 | 50 | 50 | 50 | 50 | 50 | 50 | 50 | 50 | 50 |

[Post alarm]

[Transmission interval]

Select the transmission interval for the alarm image transmission from the following.

When 60fps mode, 30fps mode or 15fps mode is selected for [Image capture mode]:

0.1fps/ 0.2fps/ 0.33fps/ 0.5fps/ 1fps/ 2fps/ 3fps

When 50fps mode, 25fps mode or 12.5fps mode is selected for [Image capture mode]:

0.08fps/ 0.17fps/ 0.28fps/ 0.42fps/ 1fps/ 2fps/ 3fps

[Number of images]

Select the number of images to be transmitted from the following.

[1 pic]/[2 pics]/[3 pics]/[4 pics]/[5 pics]/[6 pics]/[7 pics]/[8 pics]/[9 pics]/[10 pics]/[20 pics]/[30 pics]/[50 pics]/[100 pics]/[200 pics]/[300 pics]/[500 pics]/[1000 pics]/[1500 pics]/[2000 pics]/[3000 pics]

[Recording duration]

Approximate time to be taken to save the set [Number of images] with the set [Transmission interval] will be displayed.



[Note:]

- If the resolution of the image to be transmitted is set to JPEG(1), and the JPEG(1) resolution is larger than [1920 × 1080], the maximum refresh interval will be 1fps.
- If the refresh interval is higher than 1fps, the maximum number of pre-alarm images is 10.

[Image capture size]

Select the image capture size of images transmitted when an alarm occurs from the following.
JPEG(1)/JPEG(2)

Alarm setting (server 2)

[Alarm image transmission]

Select [On] or [Off] to determine whether or not to transmit images when an alarm is detected.

[On]: Transmits an image to the server when an alarm has occurred.

[Off]: Does not transmit an image to the server when an alarm has occurred.



[Note:]

- [New X Fixed-8MP][New X Fixed-6MP][New X Fixed-5MP][Alarm image transmission] is not available when [Image capture mode] is set to [60fps Mode] or [50fps Mode].

[Directory name]

Enter the directory name where the alarm images are to be saved.

For example, enter [/ALARM] to designate the directory [ALARM] under the root directory of the server.

Number of characters that can be entered: 1 to 256 characters

Characters that cannot be entered: Double-byte and single-byte symbols " & ;

[File name]

Enter the file name used for the alarm image to be transmitted to the server. The file name will be

as follows.

File name:File name entered + Date and time (year, month, day, minute, second) + Sequence number

Number of characters that can be entered:1 to 32 characters

Characters that cannot be entered:Double-byte and single-byte symbols " & * / : ; < > ? ¥ |

When [On] is selected for [Alarm image FTP transmission], you can select the alarm type from the following.

[Terminal 1]:Transmit the image to the server when an alarm occurs in Terminal 1.

[Terminal 2]:Transmit the image to the server when an alarm occurs in Terminal 2.

[Terminal 3]:Transmit the image to the server when an alarm occurs in Terminal 3.



[Note:]

- The items that can be set differ depending on the function of the model.
- Refer to the catalog specifications for the functions installed in each model.
- Terminals 1 to 3 of [Alarm setting (Server 2)] can be selected only when terminals 1 to 3 of [Alarm setting/Alarm setting (Server 1)] are not selected.
- [Alarm setting (Server 2)] uses [FTP transmission retry], [Pre alarm], [Post alarm], and [Image capture size] of [Alarm setting/Alarm setting (Server 1)].

Periodic transmission settings

Periodic image transmission is available only for “Alarm setting/Alarm setting (Server 1)”.

[Periodic image transmission]

Select [On] or [Off] to determine whether or not to transmit images using the periodic image transmission function.

[On]:Periodic image transmission is performed.

[Off]:Images are not sent regularly.



[Note:]

- [New X Fixed-8MP][New X Fixed-6MP][New X Fixed-5MP][Periodic image transmission] is not available when [Image capture mode] is set to [60fps Mode] or [50fps Mode].



[Important]

- When using periodic image transmission, it is necessary to configure the schedule settings of FTP/SFTP periodic image transmission on the [Schedule] tab of the “Schedule” page.

→[7.3.9 Schedule: Setting FTP/SFTP Periodic Transmission \(FTP/SFTP Periodic Transmission Setting Screen\)](#)

[Directory name]

Enter the name of the directory where you want to save the image file to be sent.

For example, if you want to specify the img directory under the root directory of the server, enter [/img].

Number of characters that can be entered: 1 to 256 characters

Characters that cannot be entered: Double-byte and single-byte symbols " & ;

[File name]

Enter the image file name to be sent and select the file name format from the following.

File name + Date and time: [File name + Transmission date and time (year, month, day, minute, second) + 00] is used as the file name.

File name is fixed: Use the entered file name as it is. When set to [Fix], the transmitted files are always overwritten.

Number of characters that can be entered: 1 to 32 characters

Characters that cannot be entered: Double-byte and single-byte symbols " & ; : / * < > ? ¥ |



[Note:]

- When [Name w/time&date] is selected, the file name will be [[Entered file name] + [Time and date (year/ month/ day/ hour/ minute/ second)] + [Serial number (starting from 00)]] + [s] during summer time.
- If [Alarm setting 1] and [Periodic transmission settings] are set at the same time when an alarm occurs, [Alarm setting 1] will be performed when an alarm occurs.
- If [Alarm setting 2] and [Periodic transmission settings] are set at the same time when an alarm occurs, both [Alarm setting 2] and [Periodic transmission settings] will be performed when an alarm occurs.

[Transmission interval]

Select the interval for the periodic image transmission from the following.

[1s]/ [2s]/ [3s]/ [4s]/ [5s]/ [6s]/ [10s]/ [15s]/ [20s]/ [30s]/ [1min]/ [2min]/ [3min]/ [4min]/ [5min]/ [6min]/ [10min]/ [15min]/ [20min]/ [30min]/ [1h]/ [1.5h]/ [2h]/ [3h]/ [4h]/ [6h]/ [12h]/ [24h]

[Image capture size]

Select the image capture size of images to be transmitted from the following.

JPEG(1)/JPEG(2)

[SFTP server 1 settings](#)

[SFTP server 2 settings](#)



[Note:]

- If [Transmission protocol] is set to FTP, you cannot configure the SFTP server.

[SFTP server address]

Enter the IP address or host name of the SFTP server that sends the image.

Number of characters that can be entered: 1 to 128 characters

Input Characters: One-byte alphanumeric and one-byte symbols: . _ -



[Important]

- If you want to enter a hostname for [SFTP server address], you must configure the DNS on the [Network] tab of the network page.

→ [14.1 Networking \[Network\]](#)

[Port number]

Enter the control port number of the SFTP server.

Configurable port number: 1~65535

The following port numbers cannot be set because they are used by this computer.

20, 21, 22, 23, 25, 42, 53, 67, 68, 69, 80, 110, 123, 161, 162, 443, 554, 995, 1883, 8883, 10669, 10670, 59000~61000



[Note:]

- [MULTI] The port numbers 32768 to 49151 cannot be set.

[Host key hash]

Enter the hash value for the public key of the SFTP server.

Number of characters that can be entered: 43 to 44 characters

Input Characters: Half-pitch alphanumeric and half-pitch symbols + / =

[User name]

Enter the user name (login name) to access the SFTP server.

Number of characters that can be entered: 1 to 32 characters

Characters that cannot be entered: Double-byte and single-byte symbols " & ; ¥

[Password]

Enter the password to access the SFTP server.

Number of characters that can be entered: 0 to 32 characters

Characters that cannot be entered: Double-byte and single-byte symbols " &

FTP server 1 setting

FTP server 2 settings



[Note:]

- If [Transmission protocol] is set to SFTP, you cannot configure the FTP server.

[FTP server address]

Enter the IP address or host name of the FTP server that sends the image.

Number of characters that can be entered: 1 to 128 characters

Input Characters: One-byte alphanumeric and one-byte symbols : . _ -



[Important]

- If you want to enter a hostname for [FTP server address], you must configure the DNS on the [Network] tab of the network page.

→ [14.1 Networking \[Network\]](#)

[User name]

Enter the user name (login name) to access the FTP server.

Number of characters that can be entered: 1 to 32 characters

Characters that cannot be entered: Double-byte and single-byte symbols " & ; ¥

[Password]

Enter the password to access the FTP server.

Number of characters that can be entered: 0 to 32 characters

Characters that cannot be entered: Double-byte and single-byte symbols " &

[Control port]

Enter the control port number of the FTP server.

Configurable port number: 1~65535

The following port numbers cannot be set because they are used by this computer.

20、21、22、23、25、42、53、67、68、69、80 110、123、161、162、443、554、995、
1883、8883、10669、10670、59000~61000



[Note:]

- [MULTI] The port numbers 32768 to 49151 cannot be set.

[Recording priority]

Select FTP communication mode from Passive mode/Active mode.

Normally, select [Passive]. If you cannot connect with [Passive], switch to [Active].

[Passive]:Sets FTP communication mode to passive mode.

[Active]:Set FTP communication mode to active mode.

14.2.3 Set up an NTP server

This section configures the NTP server, including the address and port number of the NTP server.



[Important]

- If you need to set the time more accurately in system operation, use the NTP server.

[Time adjustment]

Select the time adjustment method from the following. The time adjusted in the selected manner is used as the standard time of the machine.

[Manual]:The time set in the [Basic] tab on the base page is used as the standard time of the computer.

[Synchronize to NTP Server]:The time automatically adjusted in synchronization with the NTP server is used as the standard time of the machine.

[NTP server address setting]

If you selected [Synchronization with NTP server] in [Time adjustment], select how to get the NTP server address.

[Auto]:Get the NTP server address from the DHCP server.

[Manual]:Enter the NTP server address into the [NTP server address] to configure the NTP server address.



[Important]

- To obtain [NTP server address] from a DHCP server, you must set [Network Settings] to DHCP, AutoIP, or Omakase on the [Network] tab of the network page.

→[14.1 Networking \[Network\]](#)

[NTP server address]

If you selected [Manual] in [NTP server address setting], enter the IP address or hostname of the NTP server.

Number of characters that can be entered:1 to 128 characters

Input Characters:One-byte alphanumeric and one-byte symbols : . _ -



[Important]

- To enter a hostname for [NTP server address], you must configure the DNS on the [Network] tab of the network page.

→[14.1 Networking \[Network\]](#)

[NTP port]

Enter the port number of the NTP server.

Configurable port number:1~65535

The following port numbers cannot be set because they are used by this computer.

20、21、22、23、25、42、53、67、68、69、80 110、123、161、162、443、554、995、1883、8883、10669、10670、59000~61000



[Note:]

- [MULTI] The port numbers 32768 to 49151 cannot be set.

[Time adjustment interval]

Select the interval (in 1-24 hour increments) at which the time is to be acquired from the NTP server.

[NTP test]

Select [Synchronization with NTP server] for [Time adjustment], set up the NTP server, and then press [Execute]. You can communicate with the NTP server, perform time synchronization, and check the NTP operation.



[Note:]

- When the NTP test is successful, the [The NTP time correction completed successfully.] is displayed.
- If the NTP test fails, the [The NTP time correction failed.] is displayed.
- If [Time adjustment] is set to [Manual], the [Execute] buttons for NTP tests will be grayed out.
- If [Time adjustment] is set to [Synchronization with NTP server] and the NTP server address is not set, the [Execute] buttons for the NTP tests are grayed out.

14.2.4 Set UPnP



[Note:]

- [MULTI_PTZ] When UPnP is set to ON and access via the Internet is set to [Multi-directional + PTZ] by [Live view], only the image of the accessed camera is displayed.

This machine supports UPnP (Universal Plug and Play). The UPnP function enables you to set the following settings automatically.

- configure the port forwarding function for routers. However, a UPnP-enabled router is required. This setting is useful for accessing the camera from the Internet or from a mobile or tablet terminal.
- Create a shortcut to the camera in the [Network] folder of the PC and update the shortcut automatically even if the camera has changed IP addresses.

[Auto port forwarding]

Configure on/off whether to use the router's port forwarding function.

To use the Automatic Port Forwarding feature, the router you use must be UPnP-enabled and UPnP enabled.



[Note:]

- Automatic port forwarding may change the port number. If this is changed, the port number of the camera registered on the PC or recorder must be changed.
- The UPnP feature can be used to connect a camera to an IPv4 network. IPv6 is not supported.
- To verify that auto-port forwarding has been configured correctly, click on the [Status] tab on the Maintenance page and make sure that the [UPnP] status is [On].
 - [16.3 \[Status\] for checking the status](#)
- If [On] is not displayed, please read [Cannot access cameras from internet] in "Trouble!?"
 - [18.2 Trouble!?](#)
- If the live screen or configuration screen is not displayed correctly, such as when replacing the routers to be used, set [UPnP(Auto port forwarding)] to [Off] once and then set it to [On] again.

[Camera short cut]

Use the [On] and [Off] buttons to specify whether to make shortcuts to the cameras in the [Network] folder of your computer.

Select [On] to shortcut the cameras.

To use the camera shortcut function, enable the UPnP function on the PC beforehand.



[Note:]

- You must add a Windows component to view shortcuts to the cameras in the Windows [Network] folder. Enable UPnP by referring to the following.
Start > [Set] > Network and Internet > Ethernet > Network and Sharing Center > Enable Network Discovery in Change Shared Advanced Settings > Click Save Change.

14.2.5 Set up HTTPS

By using the HTTPS function, you can encrypt the access to the camera and increase the security of communication.

For details on how to configure HTTPS, see below.

→[14.3 Setting up HTTPS](#)



[Note:]

- [MULTI_PTZ] When the HTTPS connection is accessed, only the camera accessed is protected.

[HTTPS—Connection]

Set the connection method to the machine.

HTTP & HTTPS: HTTP and HTTPS connections are enabled.

HTTPS: Only the HTTPS connection is enabled.

Select the TLS to be used when HTTPS is selected.

TLS1.1、TLS1.2: Enable/disable.

TLS1.3: It is always valid and cannot be set to invalid.



[Note:]

- To connect to HTTPS when HTTP is selected, first configure the HTTPS connection. The HTTPS connection is enabled even if the setting is changed to HTTP.
- When accessing the camera with HTTPS, the display speed of the screen and the frame rate of the movie may decrease.
- When accessing the camera with HTTPS, it may take a long time before the

image is displayed.

- When you access the camera with HTTPS, the image may be distorted or the sound may be interrupted.
- If you set the connectivity to [HTTPS], the maximum delivery is limited to 32Mbps.
- It is recommended that TLS 1.1 be disabled for security reasons.
- When TLS1.1 is enabled, TLS1.2 is also enabled.
- When TLS1.2 is disabled, TLS1.1 is also disabled.
- When you change the TLS1.2 setting, you need to reboot the camera. After rebooting, you cannot perform operations for around 2 minutes, just as when the camera is turned on.

[HTTPS-Select Certificate]

Select the certificate to use in HTTPS.

[Pre-install]:Select the pre-installation certificate.

CA:Select a CA certificate. This is displayed only if the CA certificate is installed.

[HTTPS-HTTPS port]

Set the port number to use for HTTPS.

Configurable port number:1~65535

The following port numbers cannot be set because they are used by this computer.

20、21、22、23、25、42、53、67、68、69、80 110、123、161、162、443、554、995、
1883、8883、10669、10670、59000~61000



[Note:]

- [MULTI] The port numbers 32768 to 49151 cannot be set.

[Pre-installation Certificate-Root Certificate Acquisition]

Clicking [Execute] downloads the root certificate for the pre-installation certificate. By installing the root certificate on your PC, you can verify the signature of the pre-installation certificate.

[CA certificate-CRT key generate]

Creates a CRT key (SSL encryption key) for use in an HTTPS connection using a CA certificate. CRT key generation is performed in [CRT key generation dialog] displayed when [Execute] is clicked.

[CA Certificate-Generate Certificate Signing Request]

This generates a signature request (CSR Certificate Signing Request) to apply to a Certificate Authority when using a security certificate issued by a CA (Certificate Authority) as a security

certificate to be used in HTTPS.

Create a signature request (CSR) by clicking on the [Execute] button. This is displayed in the [Create Signature Request (CSR) dialog].

[CA certificate-CA certificate install]

Install the CA certificate (security certificate) issued by the certification authority and display information about the installed CA certificate (security certificate).

When [Select File] is clicked, the [Open Dialog] is displayed. Select the CA certificate (security certificate) file issued by the authentication authority. Click [Execute] to install the CA certificate (security certificate).

If a CA certificate (security certificate) is installed, the file name of the installed CA certificate (security certificate) is displayed.

[CA certificate-information]

The information of the CA certificate (security certificate) is displayed.

When [Execute] is clicked, the registered contents of the installed CA certificate (security certificate) are displayed in the [CA Certificate Confirmation Dialog]. If a CA certificate (security certificate) is not installed, the content of the generated signature request (CSR) is displayed. Clicking [Delete] deletes the installed CA certificate (security certificate).



[Important]

- When deleting a valid CA certificate (security certificate), make sure that you have a backup of the CA certificate (security certificate) on your PC or recording media. To reinstall, a CA certificate (security certificate) is required.



[Note:]

- If the connection method setting is changed, the connection must be accessed again after a while using [http://Camera IP address] or [https://Camera IP address].
- When accessing the camera with HTTPS, the display speed of the screen and the frame rate of the movie may decrease.
- When accessing the camera with HTTPS, it may take a long time before the image is displayed.
- When you access the camera with HTTPS, the image may be distorted or the sound may be interrupted.
- If you set the connectivity to [HTTPS], the maximum delivery is limited to 32Mbps.

14.2.6 Set up DDNS

To access the computer via the Internet, you must configure the DDNS function.
See below for instructions on how to configure DDNS.

→[14.4 How to configure DDNS](#)

[Area]

Select the region where the camera is installed.

[Japan]/[Global]



[Note:]

- Select [Japan] when using cameras in Japan. The [Viewnetcam.com] services displayed when [Global] is selected are not accessible from within Japan.
- [Indoor PTZ] [Viewnetcam.com] service does not appear even if you select [Global].

[Service]

Select whether or not to use the DDNS service to be used.

[Off]: Do not use DDNS.

[Viewed Net]: Use [Viewnetcam.com] services.

[Dynamic DNS Update]: [DHCP-NON] Dynamic DNS Update (RFC 2136 compliant) is used without DHCP linkage.

[Dynamic DNS Update]: [DHCP] Dynamic DNS Update (RFC 2136 compliant) is used for DHCP linkage.



[Note:]

- If you use DNS Update [Dynamic DNS Update (RFC2136)], contact your network administrator to select DHCP or DHCP linkage.

14.2.7 Set SNMP

Here, the setting for the SNMP function is performed. Connecting using the SNMP Manager enables you to check the status of your computer. Contact your network administrator if you want to use the SNMP feature.

SNMP setting

[SNMP setting]

Set whether to Enable/Disable the SNMP function.



[Note:]

- If [SNMP setting] is set to [Disable], [SNMP agent setting] and [SNMP trap setting] cannot be set.

SNMP agent setting

[SNMP version]

Select the SNMP version to be used.

[SNMPv1/v2]:SNMPv1/v2 is enabled.

[SNMPv3]:SNMPv3 is enabled.

[SNMPv1/v2/v3]:SNMPv1/v2/v3 is enabled.

SNMPv1/v2 – [Community]

Enter the community name to be monitored.

Number of characters that can be entered:0 to 32 characters

Characters that cannot be entered:Double-byte

Initial setting:Blank space



[Important]

- When using the SNMP feature on SNMPv1/v2, be sure to enter a community name. If the community name is blank, you cannot use the SNMP feature. Do not set a community name that can be easily guessed. (e.g., public)

SNMPv1/v2 – [Manager address]

When the SNMP version is v1 and v2, enter the IP address of the SNMP manager that allows requests. If blank, allow requests from all IP addresses.

Number of characters that can be entered:1 to 128 characters

Input Characters:One-byte alphanumeric and one-byte symbols : . /



[Note:]

You can restrict the IP address of the SNMP manager to allow requests per subnet by entering the IP address/Mask length of the subnet.

For example, if you enter [192.168.0.1/24], SNMP manager requests from [192.168.0.1] to [192.168.0.254] are allowed.

[SNMPv3] – [User name (1 to 32 characters)]

Set the SNMPv3 username.

Number of characters that can be entered:Blank or 1 to 32 characters

Characters that cannot be entered:Double-byte and single-byte symbols " & ; ¥

[SNMPv3]—[Authentication]

Displays the SNMPv3 authentication method.



[Note:]

- If you upgrade while [MD5] is set in [Authentication], the [Authentication] operates using [MD5]. Click the [Set] button to change [Authentication] to [SHA1].

[SNMPv3] — [Encryption method]

Select the SNMPv3 encryption method from DES/AES.

[SNMPv3] — [Password]

Set the SNMPv3 password.

Number of characters that can be entered:blank or 8–20 characters

Characters that cannot be entered:Double-byte and single-byte symbols " &

[SNMPv2-MIB systemFixed](#)

[System name]

Enter the device name to manage the machine using the SNMP function.

Number of characters that can be entered:0 to 32 characters

Characters that cannot be entered:Double-byte

[Location]

Enter the location where the machine was installed.

Number of characters that can be entered:0 to 32 characters

[Contact]

Enter the administrator's mail address or phone number.

Number of characters that can be entered:0 to 255 characters

Characters that cannot be entered:Double-byte

[SNMP trap settings]

Sets ON/OFF of SNMP trap notification.

[Destination of Trap] — [Address]

SNMP Enter the destination address for the trap notification.

Number of characters that can be entered:1 to 128 characters

Input Characters:One-byte alphanumeric and one-byte symbols : .



[Important]

- IPv6 address and hostname cannot be used as the notification destination.

[SNMPv2c] – [Community]

Enter the community name of the SNMP trap notification destination.

Number of characters that can be entered:0 to 32 characters

Characters that cannot be entered:Double-byte

Trap notificationFixed

[SNMP Generic trap] – [coldStart] – [Enable/Disable]

If the check box is checked, the trap (SNMPv2-MIB::coldStart) is notified when the camera starts.

[SNMP Generic trap] – [coldStart] – [Trap string]

If you want to extend the trap when the computer starts, you can set the character string.

Number of characters that can be entered:0 to 32 characters

Input Characters:0–9 (half-pitch), A–Z (half-pitch, uppercase, lowercase) and half-pitch symbol !

” # \$ % & ’ () * + , - . / : ; = ?

[SNMP Generic trap] – [linkUp] – [Enable/Disable]

When the checkbox is checked, the trap (SNMPv2-MIB::linkup) is notified when the machine is linked up.

[SNMP Generic trap] – [LinkUp] – [Trap string]

To extend the trap when the computer is linked up and notify, set the character string.

Number of characters that can be entered:0 to 32 characters

Input Characters:0–9 (half-pitch), A–Z (half-pitch, uppercase, lowercase) and half-pitch symbol !

” # \$ % & ’ () * + , - . / : ; = ?

[SNMP Generic trap] – [authenticationFailure] – [Enable/Disable]

If the check box is checked, a trap (SNMPv2-MIB: authentication failure) is notified when an SNMP authentication error occurs.

[SNMP Generic trap] – [authenticationFailure] – [Trap string]

If you want to extend the trap when an SNMP authentication error occurs, you can set the string.

Number of characters that can be entered:0 to 32 characters

Input Characters:0–9 (half-pitch), A–Z (half-pitch, uppercase, lowercase) and half-pitch symbol !

” # \$ % & ’ () * + , - . / : ; = ?

[Alarm]–[Terminal 1]–[Enable/Disable]

When the check box is checked, the trap is notified when an alarm is generated at terminal 1.

[Alarm]–[Terminal 1]–[Trap string]

Set the character string to be used for notifying [Terminal 1] traps.

Number of characters that can be entered:0 to 32 characters

Input Characters:0–9 (half-pitch), A–Z (half-pitch, uppercase, lowercase) and half-pitch symbol !

” # \$ % & ’ () * + , - . / : ; = ?

[Alarm]–[terminal 2]–[Enable/Disable]

When the check box is checked, the trap is notified when an alarm is generated at terminal 2.

[Alarm]–Terminal 2–[Trap string]

Set the character string to be used for notifying [Terminal 2] traps.

Number of characters that can be entered:0 to 32 characters

Input Characters:0–9 (half–pitch), A–Z (half–pitch, uppercase, lowercase) and half–pitch symbol !

” # \$ % & ’ () * + , - . / : ; = ?

[Alarm]–Terminal 3–[Enable/Disable]

When the check box is checked, the trap is notified when an alarm is generated at terminal 3.

[Alarm]–Terminal 3–[Trap string]

Set the character string to be used for notifying [Terminal 3] traps.

Number of characters that can be entered:0 to 32 characters

Input Characters:0–9 (half–pitch), A–Z (half–pitch, uppercase, lowercase) and half–pitch symbol !

” # \$ % & ’ () * + , - . / : ; = ?

[Alarm] – [VMD] – [Enable/Disable]

When the check box is checked, the trap is notified when the operation is detected.

[Alarm] – [VMD] – [Trap string]

Specify the strings to be used to notify [VMD] traps.

Number of characters that can be entered:0 to 32 characters

Input Characters:0 to 9 (half–pitch), A to Z (half–pitch, uppercase, lowercase), half–pitch symbol

!” # \$ % & ’ () * + , - . / : ; = ?

[Alarm] – [Auto track] – [Enable/Disable]

When the check box is checked, the trap is notified when automatic tracking occurs.

[Alarm] – [Auto track] – [Trap string]

Specify the strings to be used to notify [Auto track] traps.

Number of characters that can be entered:0 to 32 characters

Input Characters:0–9 (half–pitch), A–Z (half–pitch, uppercase, lowercase) and half–pitch symbol !

” # \$ % & ’ () * + , - . / : ; = ?

[Alarm] – [Audio detection] – [Enable/Disable]

When the check box is checked, the trap is notified when sound detection occurs.

[Alarm] – [Audio detection] – [Trap string]

Specify the strings to be used to notify [Audio detection] traps.

Number of characters that can be entered:0 to 32 characters

Input Characters:0–9 (half–pitch), A–Z (half–pitch, uppercase, lowercase) and half–pitch symbol !

” # \$ % & ’ () * + , - . / : ; = ?

[Alarm] – [Command alarm] – [Enable/Disable]

When the check box is checked, the trap is notified when a command alarm occurs.

[Alarm] – [Command alarm] – [Trap string]

Specify the strings to be used to notify [Command alarm] traps.

Number of characters that can be entered:0 to 32 characters

Input Characters:0–9 (half-pitch), A–Z (half-pitch, uppercase, lowercase) and half-pitch symbol !
" # \$ % & ' () * + , - . / : ; = ?

[Alarm] – [Impact detection] – [Enable/Disable]

When the check box is checked, the trap is notified when impact detection occurs.

[Alarm] – [Impact detection] – [Trap string]

Specify the strings to be used to notify [Impact detection] traps.

Number of characters that can be entered:0 to 32 characters

Input Characters:0–9 (half-pitch), A–Z (half-pitch, uppercase, lowercase) and half-pitch symbol !
" # \$ % & ' () * + , - . / : ; = ?

[Alarm] – [Casing open detection] – [Enable/Disable]

When the check box is checked, the trap is notified when opening detection occurs.

[Alarm] – [Casing open detection] – [Trap string]

Specify the strings to be used to notify [Casing open detection] traps.

Number of characters that can be entered:0 to 32 characters

Input Characters:0–9 (half-pitch), A–Z (half-pitch, uppercase, lowercase) and half-pitch symbol !
" # \$ % & ' () * + , - . / : ; = ?

SD Memory Card–[Diag.]–[Enable/Disable]

When the check box is checked, the trap is notified in the following cases.

When notifying the remaining capacity of the SD Memory Card

–when the free space on the SD memory card is insufficient

–SD Memory Card recognition error

SD Memory Card–[Diag.]–[Trap string]

Specify the strings to be used to notify [Diag.] traps.

Number of characters that can be entered:0 to 32 characters

Input Characters:0–9 (half-pitch), A–Z (half-pitch, uppercase, lowercase) and half-pitch symbol !
" # \$ % & ' () * + , - . / : ; = ?



[Note:]

- The items that can be set differ depending on the function of the model.
- Refer to the catalog specifications for the functions installed in each model.
- [PTZ] [Auto track] can be set only for PTZ-cameras.

14.2.8 Set QoS

This section configures the settings for the Diffserv function and the shaping of streams.

Diffserv

The Diffserv feature sets the priority of image/voice data forwarded from the router and other commands.

The priority you set on your computer must be matched to the DSCP value set on the router.

Contact your network administrator if you want to use the Diffserv function.

[Image DSCP(0-63)]

Enter the packet priority order for the video data.

Configurable values:0~63

[Audio DSCP(0-63)]

Enter the packet priority order for audio distribution.

Configurable values:0~63

TCP alarm notification DSCP (0-63)

Enter the packet priority order for the unique alarm notification.

Configurable values:0~63

Shaping of streams

[Shaping of stream]

Use the [On] [Off] to control whether H.265 (or H264) images are not bursted.

It may be effective when network devices divert image data from the camera, etc., but the displayed image may be delayed.

[Off]:Disables the shaping function of the stream.

[On]:Enables the shaping function of the stream.



[Note:]

• If you are concerned about the delay of the image to be displayed, set it to Off.

14.2.9 Configure SRTP

Here, the settings for the SRTP function are performed.

[SRTP]

Use [On] or [Off] to set whether to use the SRTP function.

[On]:Use the SRTP function.

[Off]:The SRTP function is not used.



[Note:]

- You can also deliver RTP if SRTP is set to [On].
- For client information that can be connected to the camera using the SRTP function, please refer to our technical information website<Control No. C0318>.

14.2.10 Set MQTT

This section configures the MQTT (Message Queuing Telemetry Transport) function. When an alarm is generated, the MQTT server can be notified of an event caused by the alarm.

[MQTT settings]

Use [On]/[Off] to specify whether the MQTT function is enabled or not.

Connect to the configured server if it is set to [On] or [On] when the cameras are started.

When the set alarm occurs, the setting is notified to the server.

[On]:Use the MQTT function.

[Off]:MQTT function is not used.

Server

[Address]

Enter the IP address or host name of the MQTT server to be notified when an alarm is generated.

Number of characters that can be entered:1 to 128 characters

Input Characters:One-byte alphanumeric and one-byte symbols : . _ -

[Port number]

Enter the MQTT server port number.

Configurable port number:1~65535

The following port numbers cannot be set because they are used by this computer.

20、21、22、23、25、42、53、67、68、69、80 110、123、161、162、443、554、995、
1883、8883、10669、10670、59000~61000



[Note:]

- [MULTI] The port numbers 32768 to 49151 cannot be set.

[Protocol]

Select the protocol to be used for connection with the MQTT server from MQTT over SSL/MQTT over TCP.

MQTT over SSL:Encrypt communication with the MQTT server with SSL.

MQTT over TCP:Do not encrypt communication with the MQTT server.

[User name]

Enter the user name to access the MQTT server.

Number of characters that can be entered:0 to 32 characters

Characters that cannot be entered:Double-byte and single-byte symbols " & ; ¥

[Password]

Enter the password to access the MQTT server.

Number of characters that can be entered:0 to 32 characters

Characters that cannot be entered:Double-byte and single-byte symbols " &

Root CA certification[Book](#)

[Installation]

Install the root CA certificate issued by the certification authority.

When [Select File] is clicked, the [Open File Dialog] is displayed. Select the root CA certificate file issued by the authentication authority. Click [Execute] to install the root CA certificate.

The data format of the root CA certificate can be PEM or DER.

[Information]

The root CA certificate information is displayed.

[Off]:Root CA certificate is not installed.

Root CA Certificate Host Name:Displayed when installed.

You can view the root CA certificate in detail by clicking [Execute].

Clicking [Delete] deletes the installed root CA certificate.

[Server certificate verification]

Select [MQTT over SSL] for [Protocol] and, if [Server certificate verification] is [On], verify the server certificate using the root CA certificate registered when connecting to SSL.



[Note:]

If the [Server certificate verification] is [On], install the root CA certificate.

Provision of notice[Fixed](#)

[Alarm]

Check the alarm event to notify the MQTT server.

[Terminal 1]:The MQTT server is notified when an alarm is generated at terminal 1.

[Terminal 2]:The MQTT server is notified when an alarm is generated at terminal 2.

[Terminal 3]The MQTT server is notified when an alarm is generated at terminal 3.

[VMD]:The MQTT server is notified when an operation detection occurs.

[Audio detection]:Notifies the MQTT server when sound detection occurs.

[Command alarm]:Notifies the MQTT server when a command alarm is entered.

[Impact detection]:Notifies the MQTT server when impact detection occurs.

[Casing open detection]:Notifies the MQTT server when opening detection occurs.

[Topic]

Specify the name of the MQTT topic to be sent. The topics are hierarchically separated by /.

Number of characters that can be entered:1 to 128 characters

Input Characters:Single-byte alphanumeric and single-byte symbols

Prohibited Characters:One-byte symbol ¥

[Payload]

Set the MQTT message payload.

Number of characters that can be entered:1 to 128 characters

Input Characters:Single-byte alphanumeric and single-byte symbols

Prohibited Characters:One-byte symbol ¥

[QoS]

Select the level of QoS from 0, 1, or 2. 0<1<Communication quality is high with 2.

0:QoS0 delivers up to one message. Messages are not guaranteed to reach the server.

1:In QoS1, messages are delivered at least once. Messages are guaranteed to reach the destination, but may be duplicated.

2:QoS2 delivers the message exactly once. Messages are guaranteed to arrive only once without excess or deficiency.

[Retain]

Check this box to have the last notified message saved on the MQTT server.

14.2.11 Configure LLDP

This section configures the LLDP (Link Layer Discovery Protocol) function. Interoperation can be realized by transmitting and receiving the device information of the camera with LLDP-compatible devices.

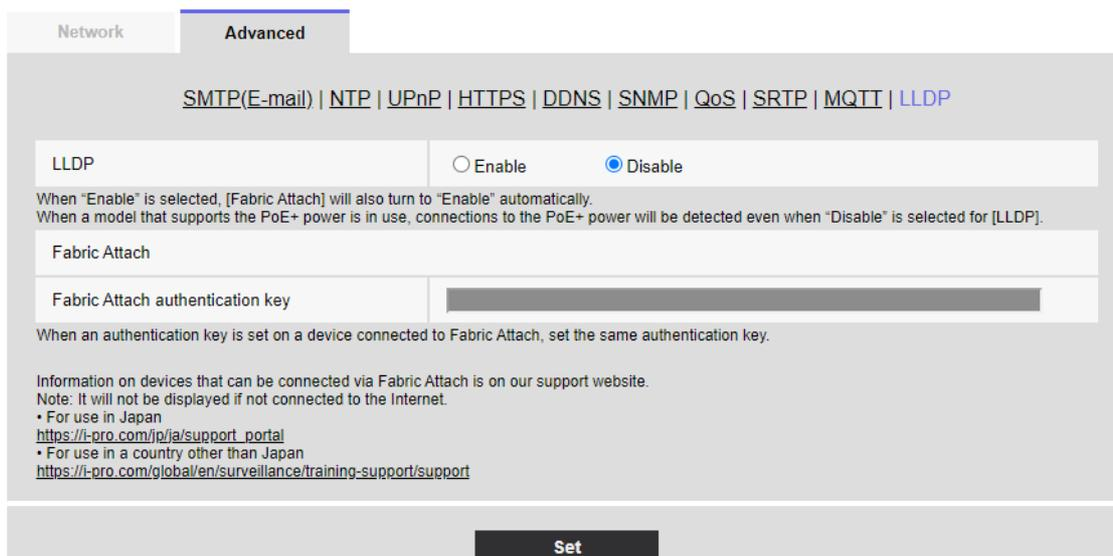

[LLDP]

You can configure [On] and [Off] to enable the LLDP function and Fabric Attach.

[Enable]:Use the LLDP function.

[Disabled]:The LLDP function is not used.

When set to [On], LLDP is sent with TLVs checked in the following tables.

| End Of LLDPDU TLV | Chassis ID TLV | Port ID TLV | Time To Live TLV | Port Description TLV | System Name TLV | System Description TLV | System Capability TLV | Management Address TLV | IEEE802.3 Power via MDI TLV | Fabric Attach Element TLV |
|-------------------|----------------|-------------|------------------|----------------------|-----------------|------------------------|-----------------------|------------------------|-----------------------------|---------------------------|
| ✓ | ✓ | ✓ | ✓ | ✓ | ✓ | ✓ | ✓ | ✓ | ✓ | ✓ |

For the model supporting *PoE+ power supply, LLDP including TLV with checks in the following table is sent for PoE+ power supply even if set to [Off].

| End Of LLDPDU TLV | Chassis ID TLV | Port ID TLV | Time To Live TLV | Port Description TLV | System Name TLV | System Description TLV | System Capability TLV | Management Address TLV | IEEE802.3 Power via MDI TLV | Fabric Attach Element TLV |
|-------------------|----------------|-------------|------------------|----------------------|-----------------|------------------------|-----------------------|------------------------|-----------------------------|---------------------------|
| ✓ | ✓ | ✓ | ✓ | | | | | | ✓ | |

Fabric Attach authentication key

Enter the key to be used for Fabric Attach authentication. It is valid only when [LLDP] is [On].

Number of characters that can be entered:0 to 32 characters (blank if not Fabric Attach authentication)

Input Characters:One-byte alphanumeric characters



[Note:]

- Press [Set] to restart the computer. After restarting, the product cannot be operated for about two minutes as it was when the power was turned on.
- Information on devices that can be connected via Fabric Attach can be found on our technical information website.

14.3 Setting up HTTPS

Here, you set up HTTPS to encrypt camera access and enhance communication security.

HTTPS can be configured using pre-installed certificates on the camera body or using CA (CA) certificates obtained between the customer and the certification authority.

HTTPS setting method (pre-installation) is shown on the support video page of the support site.

<Control No. P0002>. Please refer to configure HTTPS (CA certificate)<Control No. P0003>.



[Note:]

- [MULTI_PTZ] When the HTTPS connection is accessed, only the camera accessed is protected.
- [Subject Alternative Name] can be set in [Signature Request (CSR) Generation Dialog] in the software Ver.2.50. For details, please read the following.
→ [14.3.1 How to generate a signing request \(CSR\)](#)

14.3.1 How to generate a signing request (CSR)

- 1 Click the [Execute] button in [CA Certificate – Generate Certificate Signing Request].
→ The “CA Certificate – Generate Certificate Signing Request” screen is displayed.

| CA Certificate - Generate Certificate Signing Request | | |
|-------------------------------------------------------|----------------------|-------------------------------------------------------------------------|
| Common Name | <input type="text"/> | |
| Subject Alternative Name | <input type="text"/> | |
| Country | <input type="text"/> | |
| State | <input type="text"/> | |
| Locality | <input type="text"/> | |
| Organization | <input type="text"/> | |
| Organizational Unit | <input type="text"/> | |
| CRT key | RSA key size | 2048bit |
| | Last modified | 2023/12/22 13:15:41 |
| | | <input type="button" value="OK"/> <input type="button" value="Cancel"/> |

2 Enter the information for the certificate to be generated.

| Item | Explanation | Available number of characters |
|----------------------------|----------------------------------------------------------------------------------|------------------------------------------------------------------------|
| [Host name] | Enter the camera address or the host name. | 64 characters |
| [Subject Alternative Name] | Enter the domain name. | 64 characters per domain Available number of domain registration: 8 |
| [Country] | Enter the country code. | 2 characters: Country code |
| [State] | Enter the name of the state. | 128 characters |
| [Locality] | Enter the name of the locality. | 128 characters |
| [Organization] | Enter the name of the organization. | 64 characters |
| [Organizational Unit] | Enter the name of the organizational unit. | 64 characters |
| [CRT key] | Displays the key size of the current CRT key and the date/time it was generated. | - |



[Note:]

- When using a CA certificate, make sure you enter the information that is required by the certification authority you are applying to.
- For the [Host name], [State], [Locality], [Organization], and [Organizational Unit], you can enter the following characters:

0 to 9, A to Z, a to z, and the following symbols:

- . _ , + / ()

•For the [Subject Alternative Name], you can enter the following characters:

0 to 9, A to Z, a to z, and the following symbols:

. : * , -

•When entering multiple domain names in [Subject Alternative Name], separate them with commas.

14.4 How to configure DDNS

When using the DDNS function on your computer, you can use one of the following DDNS services:

[Viewnetcam.com] services

Dynamic DNS Update (RFC 2136)



[Important]

- You must configure port forwarding for routers before using the DDNS service.
- About [Dynamic DNS (DDNS)] Update (RFC 2136)

We do not guarantee the operation of any DDNS services other than the [Viewnetcam.com] service. Therefore, you are not liable for any failure or damage caused by the use of DDNS services other than the [Viewnetcam.com] service. For selection and configuration of DDNS services other than [Viewnetcam.com] services, please contact the service provider.

- Check the [Viewnetcam.com] service website for browsers supported by the [Viewnetcam.com] service.



[Note:]

- The [Viewnetcam.com] service (fee-based) is the DDNS service we recommend. For more information about the [Viewnetcam.com] service, refer to the [Viewnetcam.com] Service website (<http://www.viewnetcam.com/>).

About DDNS Services (IPv4/IPv6)

You can view camera images via the Internet by using the DDNS service.

The DDNS service is a service that matches a domain name with a dynamically changing global address. You can configure the [Viewnetcam.com] service (charged for IPv6, but both IPv4 and IPv6 connections are required) or dynamic DNS Update (RFC2136 compliant) for DDNS services.

Since many providers provide services that change their global addresses rather than being fixed, the camera may not be able to access the previous global addresses after a period of time. To access cameras with non-fixed global addresses from the Internet, you must have one of the following services:

DDNS services (e.g., [Viewnetcam.com] services)

This service can be accessed with a fixed registered domain name (e.g., *****.miemasu.net) even if the global address changes. You must also subscribe to domain name services when using IPv6 connections.

For more information about [Viewnetcam.com] Services, see the [Viewnetcam.com] website.

Fixed IP address service (e.g. service of subscription provider)

This service does not change the global address (fixed).

DDNS Service Mechanism (for [Viewnetcam.com] Service)

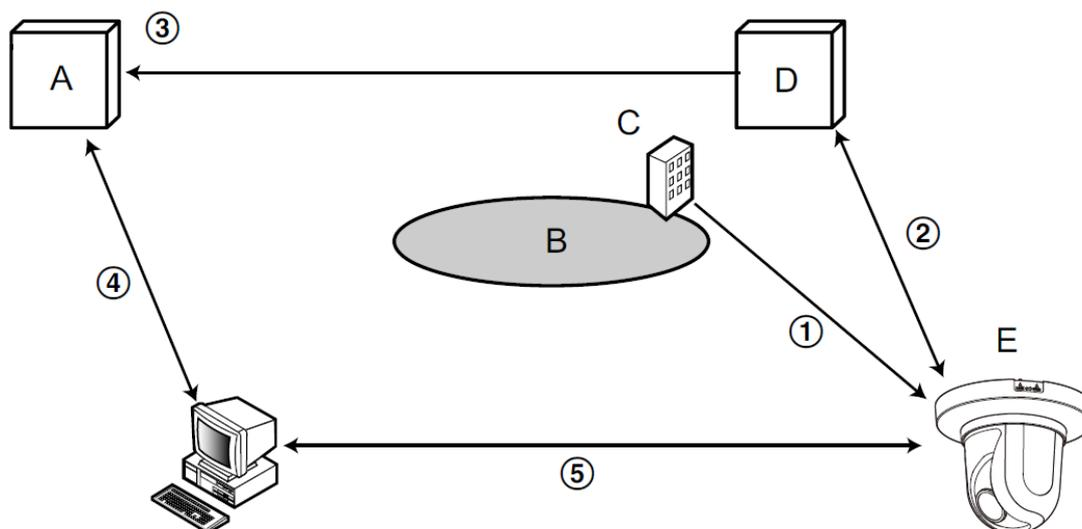

- A. DNS server
- B. Internet
- C. Provider
- D. "Viewnetcam.com" service server
- E. Remote site

- ① The contracted provider assigns a global address to the router (or camera). The global address assigned at this time is not a fixed but a changing address.
- ② If you subscribe to [Viewnetcam.com] services, the cameras are assigned a unique [Domain Name] (e.g., *****.miemasu.net). The camera manages the camera's domain name and the global address of the router (or camera) by automatically notifying the [Viewnetcam.com] service server of the router's (or camera's) global address (the [Viewnetcam.com] service server).

- ③ The [Viewnetcam.com] service server registers the global addresses and domain names of routers (or cameras) with the DNS server.
- ④ When accessing a camera via the Internet, the DNS server determines the global address of the registered router (or camera) by entering the URL containing the domain name into the Web browser.
- ⑤ You can access routers (or cameras) with an indexed global address to monitor the image.

**[Note:]**

- Contact your provider to determine whether your IP address is fixed.
- Depending on the provider, local addresses may be assigned. In that case, the DDNS service is not available. Please contact the provider you subscribe to.

14.4.1 With [Viewnetcam.com] services

- 1 On the [Advanced] tab of the Network Page, select [DDNS], and then select [Japan] from the [Area] tab.

Network **Advanced**

[SMTP\(E-mail\)](#) | [FTP/SFTP](#) | [NTP](#) | [UPnP](#) | [HTTPS](#) | **[DDNS](#)** | [SNMP](#) | [QoS](#) | [SRTP](#) | [MQTT](#)

| DDNS | |
|---------------------------------------|------------------------------------------------------------------------|
| Area | Global ▼ |
| Service | Viewnetcam.com ▼ |
| Personal(Camera) URL | |
| Your Account Link | |
| Access interval | 1h ▼ |
| Global IP Address Notification Method | <input checked="" type="radio"/> Normal <input type="radio"/> Advanced |

Set

- 2 Select [Viewnetcam.com] and press [Set].

| Network | Advanced | i-PRO Web Service | Stratocast |
|-----------------------------------------------------------------------------------------------------------------------------------------------------------------------------------------------------------------------------------------------------------------------|-------------------------|-------------------|------------|
| SMTP(E-mail) FTP/SFTP NTP UPnP HTTPS DDNS SNMP QoS SRTP MQTT LLDP | | | |
| DDNS | | | |
| Area | Global | | |
| Service | Viewnetcam.com | | |
| Personal(Camera) URL | haru4000.viewnetcam.com | | |
| Your Account Link | | | |

- 3 Clicking on the URLs displayed on the [Link to MIEMASUNET registration] opens a new window for registering [Viewnetcam.com] Services.
- 4 Register [Viewnetcam.com] Services according to the window. If the [Viewnetcam.com] services registration window is not displayed, check that the PC is connected to the Internet and press the Update browser button.

| Network | Advanced | i-PRO Web Service | Stratocast |
|-----------------------------------------------------------------------------------------------------------------------------------------------------------------------------------------------------------------------------------------------------------------------|-----------------------------------------------------------------------------------------------------------------------------------------------------------------------|-------------------|------------|
| SMTP(E-mail) FTP/SFTP NTP UPnP HTTPS DDNS SNMP QoS SRTP MQTT LLDP | | | |
| DDNS | | | |
| Area | Global | | |
| Service | Viewnetcam.com | | |
| Personal(Camera) URL | haru4000.viewnetcam.com | | |
| Your Account Link | https://www.viewnetcam.com/ip_ddns/index.php?v1=kuLs5JLsleP5%2BLslZfs5Zc%3D | | |

- 5 Re-display the cameras and ensure that the [Personal(Camera) URL] shows the domains (xxxx.miemasu.net:xxx) registered with the [Viewnetcam.com] services.



[Note:]

- The URLs of the registered cameras are displayed on the [Personal(Camera) URL] when registration to the [Viewnetcam.com] services has been completed. This address is used when accessing the camera via the Internet. It is recommended that you register this URL as your favorite browser function. The camera's URLs can also be viewed in the [Status] [Personal(Camera) URL] on the Camera Maintenance page.
- The URLs of the cameras can be used after they are registered with the [Viewnetcam.com] services. (It may take up to 30 minutes for the URL of the registered camera to become valid.)

However, depending on the router, this URL cannot be accessed from a PC connected to the same network (LAN) as the camera.

- If [Link to MIEMASUNET registration] is not displayed, make sure that you have registered to [Viewnetcam.com] and that your PC is connected to the Internet, and then press the Update browser button.
- If [User registered] is displayed in the [Viewnetcam.com] [Status] on the [Status] tab of the Maintenance page, restart the camera after registering the [Viewnetcam.com] service.

After restarting, make sure that the URLs registered in the [Viewnetcam.com] [Personal(Camera) URL] are displayed in the [Status] tab on the Maintenance page.

- The [Viewnetcam.com] service provides services other than dynamic DNS services. For more information, refer to the [Viewnetcam.com] services website (<http://www.viewnetcam.com/>).

Confirm the [Viewnetcam.com] services be registered

- 1 Click [Status] in the Maintenance page.

| System log | Upgrade | Status | Default reset | Data |
|------------------------|---------|-------------------------|---------------|------|
| Image transmission | | | | |
| Image transmission log | | Confirm | | |
| Viewnetcam.com | | | | |
| Server | | www.viewnetcam.com | | |
| Status | | Enable(2) | | |
| Personal(Camera) URL | | haru4000.viewnetcam.com | | |

- 2 Ensure that [Service contract is already registered.] is displayed in the [Status] of the [Viewnetcam.com] in the [Status] tabs on the Maintenance page.



[Note:]

- If you see anything other than [Service contract is already registered.] in the [Viewnetcam.com] [Status] on the [Status] tab of the Maintenance page, restart the camera and re-access the screen.

Configure port forwarding without using UPnP

If you use a router that does not support UPnP, you must manually configure the port forwarding feature for the router.

- 1 On the Network Page, press the [Network] tab.
- 2 In the [Network Settings], select [Static].
- 3 Check the IP address and port number displayed here, and make corrections if necessary. (This is required when configuring port forwarding for routers.)
- 4 Press [Set].
- 5 Configure the port forwarding by referring to your router's instruction manual.
 - Use the IP address and port number you checked in step 3 to configure.
 - Port forwarding functions may be described as address translation, static IP mascalade, virtual server, virtual server, or port mapping, depending on the router.



[Note:]

- Be sure to set [Auto port forwarding] to [Off] when configuring port forwarding manually for routers.

14.4.2 Using Dynamic DNS Update (without DHCP)

[Host name]

Enter the host name to use for the dynamic DNS Update service.

Number of characters that can be entered:3 to 250 characters (host name). Enter in (domain name) format

Input Characters:One-byte alphanumeric and one-byte symbols . -



[Note:]

- Contact your network administrator for the host name that is available.

[Access interval]

Select an interval to verify the IP address and host name for the dynamic DNS Update service server from the following.

[10min]/ [20min]/ [30min]/ [40min]/ [50min]/ [1h]/ [6h]/ [24h]

14.4.3 Using Dynamic DNS Update

[Host name]

Enter the host name to use for the dynamic DNS Update service.

Number of characters that can be entered:3 to 250 characters (host name). Enter in (domain name) format

Input Characters:One-byte alphanumeric and one-byte symbols . -



[Note:]

- Contact your network administrator for the host name that is available.

14.5 Use Remote Monitoring

On the Network page, select [Remote Monitoring].

→[5.1 How to display](#)

→[5.2 How to operate](#)

Select this setting when connecting the camera directly to Remote Monitoring.



[Note:]

- If you use Remote Monitoring, Image capture size for stream (3) and stream (4) is changed to VGA(640x360).
- Depending on the installed Extension software, internal memory used by Remote Monitoring may be insufficient. Make sure that the remaining RAM space in [Software mng.] tab. of Extension software is at least 15MB. If it is less than 15MB, Remote Monitoring does not operate normally.
- If you are using Remote Monitoring and have installed Extension software, make sure that the remaining RAM is at least 15MB in [Software mng.] section of Extension software section. If it is less than 15MB, Remote Monitoring does not operate normally.
- If you plan to use Remote Monitoring and Extension software at the same time, check to see if Extension software is available at the same time as Remote Monitoring.
- If [Miemasu.net] servicing is enabled, Remote Monitoring is not available.
- [New X Fixed-8MP] [New X Fixed-5M] When [Image capture mode] is set to [60fps Mode] or [50fps Mode], Remote Monitoring is not available.

| Network | Advanced | Remote Monitoring |
|------------------------------------------------------------------------------------------------------------------------------------------------------------------------------------------------------------------------------------------------------------------------------------------------------------------------------------------------------------------------------------------------------------------------------------------------------------------------------------------------------------------------------------------------------------------------------------------------------------------------------------------------------------------------------------------------------------------------------------------------------------------------------------------------------------------------------------------------------------------------------------------------------------------------------------------------------|-----------------------------------------------------------------------|-----------------------------------|
| Remote Monitoring | | |
| Remote Monitoring registration status | None | Registration status update |
| When you don't have a "Remote Monitoring" account yet, access the URL below and acquire an account | | |
|  | | |
| https://rms.i-pro.com/login/service-agreement | | |
| <p>For more information on Remote Monitoring compatible cameras, please refer to the following support website https://i-pro.com/products_and_solutions/en/RemoteMonitoring/en/html/RemoteMonitoring_webguide_en/manual-2.html If the "Remaining RAM" of the "Ext. software" is low, the "Remote Monitoring" cannot be executed due to insufficient memory. Please refer to the following support website for information on the extension software that can run simultaneously with the "Remote Monitoring". https://i-pro.com/products_and_solutions/en/RemoteMonitoring/en/html/RemoteMonitoring_webguide_en/manual-2.html (2.2 Supported camera information)</p> | | |
| Remote Monitoring registration setting | | |
| Remote Monitoring function | <input type="radio"/> Enable <input checked="" type="radio"/> Disable | |
| | <input checked="" type="checkbox"/> Set recommended values | |
| Remote Monitoring registration mail address | <input type="text"/> | |
| Remote Monitoring password | <input type="password"/> | |
| Set | | |

[Remote Monitoring function]

You can set the Remote Monitoring function (direct camera connection function) to Enable or Disable.

When set to Enable, or if it is already enabled when the camera starts, it will connect to the Remote Monitoring server (<https://rms.i-pro.com>).

This allows for video streaming to Remote Monitoring, playback and download of video data stored on the SD card, and receiving alarm notifications.



[Note:]

- When you select [Set recommended values], the settings will be adjusted to values suitable for Remote Monitoring connection, depending on the model.
- For details on the settings that will be adjusted when [Set recommended values] is selected, refer to the following link.

[CameraDirect-RemoteMonitoring_webguide_en](#)

[Remote Monitoring registration mail address]

The input field becomes available when you select [Enable] for the [Remote Monitoring function]. Before doing this, you need to access Remote Monitoring (<https://rms.i-pro.com>) to register your email address and set a password. Enter the email address here that you registered in Remote Monitoring.

[Remote Monitoring password]

The input field becomes available when you select [Enable] for the [Remote Monitoring function]. Before doing this, you need to access Remote Monitoring (<https://rms.i-pro.com>) to register your email address and set a password. Enter the password here that you registered in Remote Monitoring.

Setting up a direct camera connection

- 1 Select [Enable] for the [Remote Monitoring function] and enter your email address and password.

Network
Advanced
Remote Monitoring

Remote Monitoring registration status: None Registration status update

When you don't have a "Remote Monitoring" account yet, access the URL below and acquire an account



<https://rms.i-pro.com/login/service-agreement>

For more information on Remote Monitoring compatible cameras, please refer to the following support website https://i-pro.com/products_and_solutions/en/RemoteMonitoring/en/html/RemoteMonitoring_webguide_en/manual-2.html
 If the "Remaining RAM" of the "Ext. software" is low, the "Remote Monitoring" cannot be executed due to insufficient memory. Please refer to the following support website for information on the extension software that can run simultaneously with the "Remote Monitoring".
https://i-pro.com/products_and_solutions/en/RemoteMonitoring/en/html/RemoteMonitoring_webguide_en/manual-2.html (2.2 Supported camera information)

Remote Monitoring registration setting

| | |
|---------------------------------------------|------------------------------------------------------------------------------------------------------------------------------------------------------------------------------|
| Remote Monitoring function | <input checked="" type="radio"/> Enable <input type="radio"/> Disable <input checked="" type="checkbox"/> Set recommended values |
| Remote Monitoring registration mail address | <input type="text"/> |
| Remote Monitoring password | <input type="password"/> |

Set

2 Click the [Set] button.

Check the alert message and click the OK button.

When [Remote Monitoring function] is set to [Enable], the settings in the following table will be adjusted and fixed, regardless of whether or not the checkbox is selected.

| Item | Remote Monitoring Enabled |
|-----------------------------------|---------------------------|
| Audio out | Audio |
| SD Memory Card File System Format | FAT(FAT16/FAT32/exFAT) |
| Recording stream | Stream(1) |

| | |
|---------------------------------------------------------------|-----------------------------------------------------------------------------------------------|
| Image capture size of JPEG(1) | If [Image capture mode] is [16:9 mode]: 640x360 If [Image capture mode] is [4:3 mode]: VGA |
| Stream transmission of Stream(1), Stream(2) | On |
| Stream encoding format of Stream(1), Stream(2) | H.265 |
| Image capture size of Stream(4) | If [Image capture mode] is [16:9 mode]: 640x360 If [Image capture mode] is [4:3 mode]: VGA |
| TCP alarm notification, Additional extended alarm information | On |

3 Registration complete

A popup window is displayed. The registration process takes approximately 20 seconds.

Once registration is complete, [The registration is successfully completed.] is displayed, and [Remote Monitoring registration status] will show either [Registered (No license is allocated)] or [Registered (License is allocated)].

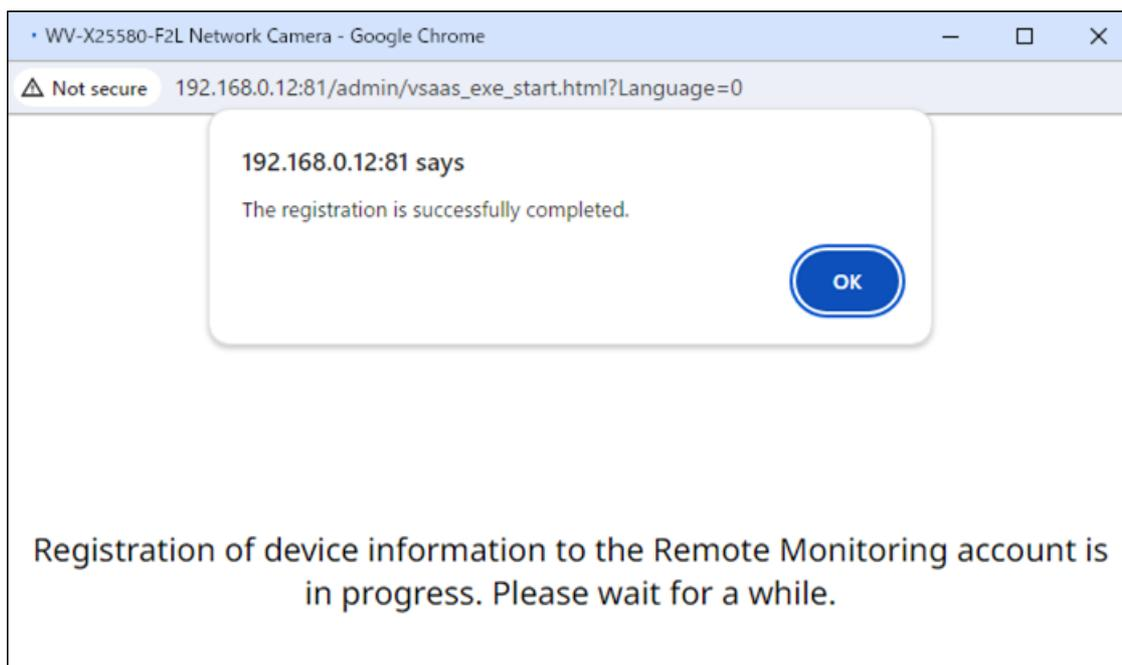

If the popup is not displayed

If popups are blocked, a notification is displayed in the address bar indicating that the popup was blocked. Allow popups to be displayed. Once this is done, set the [Remote Monitoring function] to [Disable], then switch it back to [Enable], enter your email address and password, and then click the [Set] button.

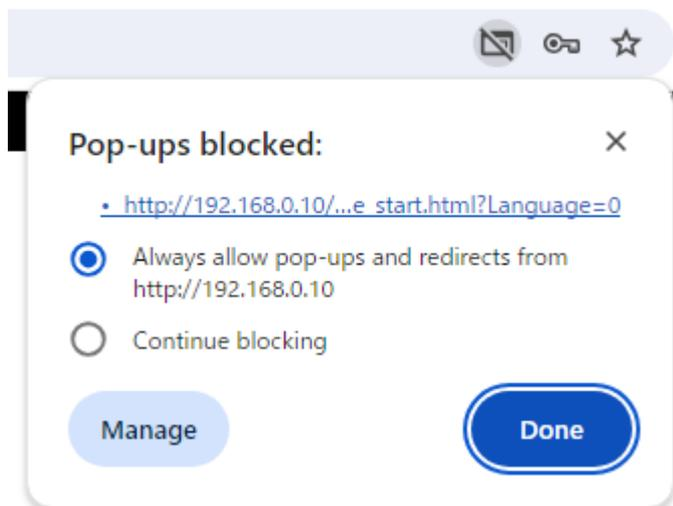

When registration is complete, close the popup by clicking the [x] at the top-right. Next, click the [Registration status update] button to confirm that [Remote Monitoring registration status] shows either [Registered (License is allocated)] or [Registered (No license is allocated)].

Correcting an incorrectly entered email address or password

Set the [Remote Monitoring function] to [Disable], then switch it back to [Enable], enter the correct email address and password, and then click the [Set] button.

If registration fails

- Check that the network camera is connected to allows external connections.
- Check that the default gateway is set correctly in the [Network] settings.
- Check that the primary server address is set correctly if DNS is set to Manual in the [Network] settings.
- Check that the date and time in the [Basic] settings match the local standard time for the camera's location.



[Note:]

- For more information about the Remote monitoring supported models, refer to our technical information website <Control No.:C0103>.

Remote Monitoring supported browser

Use Google Chrome or Microsoft Edge to access the system. Firefox may not operate correctly.

15 [Schedule] for scheduling



[Note:]

- The items that can be set differ depending on the function of the model.
- Refer to the catalog specifications for the functions installed in each model.
- [PTZ] Only PTZ cameras can be set for position refresh, automatic tracking start permission, auto pan, patrol, and preset sequence.

The Schedule page sets up schedules for the following items:

- Alarm input permission (Terminals 1, 2 and 3)
- Alarm input permission (terminal 1)
- Alarm input permission (terminal 2)
- Alarm input permission (terminal 3)
- Operation detection permission
- Permission to detect disturbance
- Sound detection permission
- Impact detection permission
- Opening detection permission
- Image disclosure permission
- SD recording
- Scene file
- Regular transmission of FTP/SFTP
- Permission to send mail
- Position refresh
- Preset position (1 to 256)
- Auto tracking start permission
- Auto pan
- Patrol
- Preset sequence
- All alarms detection permission (when visible net is set and schedule 8 only)
- <Auto Schedule>Daytime: Image Quality1 / Night: Image Quality 2 (Schedule 1 only)
- Restart the camera (Schedule 8 only)

Schedule pages consist of [Schedule] tabs only. Up to 8 schedules can be set.

- 1 From the [Operation mode], select Scheduling operation.

The default setting is [Off].

[Off]: Schedule operation is not executed.

[Alarm permission(Terminal alarm 1,2,3)]: Allows the alarm input of the terminal while the schedule is being set.

[Alarm permission(Terminal alarm 1)]: The alarm input of terminal 1 is enabled while the schedule is set.

[Alarm permission(Terminal alarm 2)]: Allows alarm input of terminal 2 while schedule is set.

[Alarm permission(Terminal alarm 3)]: Allows alarm input of terminal 3 while schedule is set.

[VMD permission]: Operation detection is enabled while the schedule is set.

[SCD permission]: Permits disturbance detection while scheduled.

[Audio detection permission]: During scheduling, sound detection is enabled.

[Impact detection permission]: During scheduling, impact detection is enabled.

[Casing open detection permission]: During scheduling, opening detection is enabled.

[Access permission]: Images are prohibited from being viewed by users with [2. Camera control] or [3. Live view] access levels set in the [User auth.] tabs, except when scheduled.

→ [13.1 \[User auth.\] to configure user-authentication](#)

[SD memory recording]: When the scheduled time is reached, SD recording set by [Recording stream] is executed. It is valid only when [Recording format] is streamed.

[All detect permission]: If [DDNS] is set to [Viewnetcam.com], only Schedule 8 can be selected. All alarm inputs are allowed while the schedule is set. [Sun] and [24h] are automatically set from [Mon] and cannot be changed.

[Image quality 1]: Scene1 (Scene File 1): When the scheduled time is reached, the image quality is set to [Scene File 1]. When the scheduled time is over, the [Scene file is not applied] image quality is set.

[Image quality 2]: Scene2 (Scene File 2): When the scheduled time is reached, the image quality is set to [Scene File 2]. When the scheduled time is over, the [Scene file is not applied] image quality is set.

[Image quality 3]: Scene3 (Scene File 3): When the scheduled time is reached, the image quality is set to [Scene File 3]. When the scheduled time is over, the [Scene file is not applied] image quality is set.

[Image quality 4]: Scene4 (Scene File 4): When the scheduled time is reached, the image quality is set to [Scene File 4]. When the scheduled time is over, the [Scene file is not applied] image quality is set.

[FTP/SFTP periodic image transmission]: When the scheduled time is reached, FTP/SFTP periodic transmission is executed.

[E-mail permission]: Mail notification is executed when an alarm is generated while the

schedule is set.

[Reboot]:When the scheduled time is reached, the camera restarts. Only available in Schedule 8.

[Position refresh]:The position is refreshed when the scheduled time is reached.

1~256:When the scheduled time is reached, the preset position is moved from the preset position registered beforehand to the selected position.

[Auto track permission]:Allows the auto-tracking setting set on the [Auto track setting] tab while scheduling.

[Auto pan]:When the scheduled time is reached, the auto pan operation set in the [Position] tab starts.

[Patrol 1]:When the scheduled time is reached, Patrol 1, which is set in the [Position] tab, starts. It is valid only when [Patrol 1] is set.

[Patrol 2]:When the scheduled time is reached, Patrol 2 set in the [Position] tab starts. It is valid only when [Patrol 2] is set.

[Patrol 3]:When the scheduled time is reached, Patrol 3, which is set in the [Position] tab, starts. It is valid only when [Patrol 3] is set.

[Patrol 4]:When the scheduled time is reached, Patrol 4, which is set in the [Position] tab, starts. It is valid only when [Patrol 4] is set.

[Preset sequence 1]:When the scheduled time is reached, preset Sequence 1 set in the [Position] tab starts. It is valid only when [Preset sequence 1] is set.

[Preset sequence 2]:When the scheduled time is reached, preset Sequence 2 set in the [Position] tab starts. It is valid only when [Preset sequence 2] is set.

[Preset sequence 3]:When the scheduled time is reached, the preset sequence 3 set in the [Position] tab starts operation. It is valid only when [Preset sequence 3] is set.

[<Automatic schedule> Daytime: Image Quality 1 / Night: Image Quality 2]: At sunrise, the image quality is set to [Scene file 1], and at sunset, the image quality is set to [Scene file 2]. Only schedule 1 can be selected. This cannot be selected if the sunrise/sunset times have not been set. Please refer to the following for the setting method.

→ [15.3 How to change the image quality based on the time of sunrise/sunset](#)

2 Checks the Day of the week boxes in which you want to schedule in [Schedule].



[Note:]

•When using [Access permission], set [User auth.] to [On] on the [User auth.] tab and [Host auth.] to [Off] on the [Host auth.] tab.

→ [13.1 \[User auth.\] to configure user-authentication](#)

→ [13.2 \[Host auth.\] to configure host-authentication](#)

- If you want to use [SD memory recording], set [Recording format] in the [SD memory card] tabs to streams and set [Save trigger] to [Schedule].
- Schedule 1 [<Automatic schedule> Daytime: Image Quality 1/ Night: Image Quality 2] and Schedules 2 to 8 [Image Quality 1: Scene 1 (Scene file 1)], [Image Quality 2: Scene 2 (Scene file 2)], [Image Quality 3: Scene 3 (Scene file 3)], and [Image Quality 4: Scene 4 (Scene file 4)] cannot be selected at the same time.

3 To specify the time, click [▼] to set the time. Select [24h] when no time zone is set.



[Note:]

- [PTZ] When you configure the [Auto pan] [Patrol] [Preset sequence], make sure that the times do not overlap.
- If [<Auto Schedule> Daytime: Image Quality 1/ Night: Image Quality 2] is selected in Schedule 1, the time zone setting will be disabled.

4 When [Set] is clicked after the setting is finished, the settings are displayed at the bottom of the window.

Schedule

Schedules

| | | | |
|----------------------------|-------------------------------------------------|-----------------------------------------------------------------------------------------------------------------------------------------------------------------------------------------------------------------------------------------------------------------------------------------|----------------------------------------------------------------------------------------------------------------------------------------------------------------------------------|
| Schedule 1 (White) | Schedule mode VMD permission | <input checked="" type="checkbox"/> Mon <input checked="" type="checkbox"/> Tue <input checked="" type="checkbox"/> Wed <input checked="" type="checkbox"/> Thu <input checked="" type="checkbox"/> Fri <input checked="" type="checkbox"/> Sat <input checked="" type="checkbox"/> Sun | Time range <input type="checkbox"/> 24h <input type="text" value="09"/> : <input type="text" value="00"/> - <input type="text" value="17"/> : <input type="text" value="00"/> |
| Schedule 2 (Blue) | Schedule mode VMD permission | <input checked="" type="checkbox"/> Mon <input checked="" type="checkbox"/> Tue <input checked="" type="checkbox"/> Wed <input checked="" type="checkbox"/> Thu <input checked="" type="checkbox"/> Fri <input checked="" type="checkbox"/> Sat <input checked="" type="checkbox"/> Sun | Time range <input type="checkbox"/> 24h <input type="text" value="23"/> : <input type="text" value="00"/> - <input type="text" value="07"/> : <input type="text" value="00"/> |
| Schedule 3 (Green) | Schedule mode FTP/SFTP periodic image transi | <input type="checkbox"/> Mon <input type="checkbox"/> Tue <input type="checkbox"/> Wed <input type="checkbox"/> Thu <input type="checkbox"/> Fri <input checked="" type="checkbox"/> Sat <input checked="" type="checkbox"/> Sun | Time range <input type="checkbox"/> 24h <input type="text" value="00"/> : <input type="text" value="00"/> - <input type="text" value="00"/> : <input type="text" value="00"/> |
| Schedule 4 (Red) | Schedule mode Off | <input type="checkbox"/> Mon <input type="checkbox"/> Tue <input type="checkbox"/> Wed <input type="checkbox"/> Thu <input type="checkbox"/> Fri <input type="checkbox"/> Sat <input type="checkbox"/> Sun | Time range <input type="checkbox"/> 24h <input type="text" value=""/> : <input type="text" value=""/> - <input type="text" value=""/> : <input type="text" value=""/> |
| Schedule 5 (Black) | Schedule mode Off | <input type="checkbox"/> Mon <input type="checkbox"/> Tue <input type="checkbox"/> Wed <input type="checkbox"/> Thu <input type="checkbox"/> Fri <input type="checkbox"/> Sat <input type="checkbox"/> Sun | Time range <input type="checkbox"/> 24h <input type="text" value=""/> : <input type="text" value=""/> - <input type="text" value=""/> : <input type="text" value=""/> |
| Schedule 6 (Yellow) | Schedule mode Off | <input type="checkbox"/> Mon <input type="checkbox"/> Tue <input type="checkbox"/> Wed <input type="checkbox"/> Thu <input type="checkbox"/> Fri <input type="checkbox"/> Sat <input type="checkbox"/> Sun | Time range <input type="checkbox"/> 24h <input type="text" value=""/> : <input type="text" value=""/> - <input type="text" value=""/> : <input type="text" value=""/> |
| Schedule 7 (Light blue) | Schedule mode Off | <input type="checkbox"/> Mon <input type="checkbox"/> Tue <input type="checkbox"/> Wed <input type="checkbox"/> Thu <input type="checkbox"/> Fri <input type="checkbox"/> Sat <input type="checkbox"/> Sun | Time range <input type="checkbox"/> 24h <input type="text" value=""/> : <input type="text" value=""/> - <input type="text" value=""/> : <input type="text" value=""/> |
| Schedule 8 (Purple) | Schedule mode Off | <input type="checkbox"/> Mon <input type="checkbox"/> Tue <input type="checkbox"/> Wed <input type="checkbox"/> Thu <input type="checkbox"/> Fri <input type="checkbox"/> Sat <input type="checkbox"/> Sun | Time range <input type="checkbox"/> 24h <input type="text" value=""/> : <input type="text" value=""/> - <input type="text" value=""/> : <input type="text" value=""/> |

Scene settings linked to sunrise and sunset times [To scene setting \(image quality adjustment\)](#)

When using this function, set the time zone. [Basic settings >>](#)

Auto Scheduler (Manual/ City Selection)

Latitude (-90.000000 - 90.000000)

Longitude (-180.000000 - 180.000000)

Altitude m (-500 - 9000)

Automatic calculation result
 Sunrise time :
 Sunset time :

Sunrise time + Minutes (-60 - 60)
 Sunset time + Minutes (-60 - 60)
 The time of the automatic calculation result can be corrected between -60 minutes and +60 minutes.

The color of each schedule is not linked with the area color of "VMD area".
 When "VMD permission" is set, the VMD functions in all the areas set with "VMD area"
 "VMD permission", "SCD permission" and "Auto track permission" are required to be set to specify a period of time where detection or tracking is to be performed. They are not required to be set when detection or tracking is to be performed regularly.
 "Auto mode (auto track)" and "Auto track from the right-click menu" on the "Live" page are available even when it is out of the period specified in "Auto track permission".
 If the camera direction is changed by other operation while the setting of preset position, auto pan, preset sequence or patrol is being performed, the camera will automatically move back to the previous preset position and resume the operation in 1 minute.

Set

487



[Note:]

- The colors displayed on Schedules 1 to 8 represent the colors of the lines displayed in the Schedule field at the bottom of the screen.
- If position refresh and image quality set time are set at the same time, the image quality is reflected after position refresh is completed.
- When the operation modes of Schedules 1 to 8 are set to [Off], the following items are permissible.

Alarm input permission (terminals 1, 2 and 3)

Alarm input permission (terminal 1)

Alarm input permission (terminal 2)

Alarm input permission (terminal 3)

Operation detection permission

Obstruction Detection Permission

-Sound detection permission

-Impact detection permission

-Opening detection permission

-Image disclosure permission

-All alarm detection permission (when visible net is set and schedule 8 only)

15.1 How to set the schedule

Schedule

Schedules

| | |
|----------------------------|-----------------------------------------------------------------------------------------------------------------------------------------------------------------------------------------------------------------------------------------------------------------------------------------------------------------------------------------------------------------------------------------------------------------------------------------------------------------------------|
| Schedule 1 (White) | Schedule mode VMD permission |
| | <input checked="" type="checkbox"/> Mon <input checked="" type="checkbox"/> Tue <input checked="" type="checkbox"/> Wed <input checked="" type="checkbox"/> Thu <input checked="" type="checkbox"/> Fri <input checked="" type="checkbox"/> Sat <input checked="" type="checkbox"/> Sun Time range <input type="checkbox"/> 24h <input type="text" value="00"/> : <input type="text" value="00"/> - <input type="text" value="17"/> : <input type="text" value="00"/> |
| Schedule 2 (Blue) | Schedule mode VMD permission |
| | <input checked="" type="checkbox"/> Mon <input checked="" type="checkbox"/> Tue <input checked="" type="checkbox"/> Wed <input checked="" type="checkbox"/> Thu <input checked="" type="checkbox"/> Fri <input checked="" type="checkbox"/> Sat <input checked="" type="checkbox"/> Sun Time range <input type="checkbox"/> 24h <input type="text" value="23"/> : <input type="text" value="00"/> - <input type="text" value="07"/> : <input type="text" value="00"/> |
| Schedule 3 (Green) | Schedule mode FTP/FTP periodic image transi |
| | <input type="checkbox"/> Mon <input type="checkbox"/> Tue <input type="checkbox"/> Wed <input type="checkbox"/> Thu <input type="checkbox"/> Fri <input type="checkbox"/> Sat <input checked="" type="checkbox"/> Sun Time range <input type="checkbox"/> 24h <input type="text" value="00"/> : <input type="text" value="00"/> - <input type="text" value="00"/> : <input type="text" value="00"/> |
| Schedule 4 (Red) | Schedule mode Off |
| | <input type="checkbox"/> Mon <input type="checkbox"/> Tue <input type="checkbox"/> Wed <input type="checkbox"/> Thu <input type="checkbox"/> Fri <input type="checkbox"/> Sat <input type="checkbox"/> Sun Time range <input type="checkbox"/> 24h <input type="text" value="00"/> : <input type="text" value="00"/> - <input type="text" value="00"/> : <input type="text" value="00"/> |
| Schedule 5 (Black) | Schedule mode Off |
| | <input type="checkbox"/> Mon <input type="checkbox"/> Tue <input type="checkbox"/> Wed <input type="checkbox"/> Thu <input type="checkbox"/> Fri <input type="checkbox"/> Sat <input type="checkbox"/> Sun Time range <input type="checkbox"/> 24h <input type="text" value="00"/> : <input type="text" value="00"/> - <input type="text" value="00"/> : <input type="text" value="00"/> |
| Schedule 6 (Yellow) | Schedule mode Off |
| | <input type="checkbox"/> Mon <input type="checkbox"/> Tue <input type="checkbox"/> Wed <input type="checkbox"/> Thu <input type="checkbox"/> Fri <input type="checkbox"/> Sat <input type="checkbox"/> Sun Time range <input type="checkbox"/> 24h <input type="text" value="00"/> : <input type="text" value="00"/> - <input type="text" value="00"/> : <input type="text" value="00"/> |
| Schedule 7 (Light blue) | Schedule mode Off |
| | <input type="checkbox"/> Mon <input type="checkbox"/> Tue <input type="checkbox"/> Wed <input type="checkbox"/> Thu <input type="checkbox"/> Fri <input type="checkbox"/> Sat <input type="checkbox"/> Sun Time range <input type="checkbox"/> 24h <input type="text" value="00"/> : <input type="text" value="00"/> - <input type="text" value="00"/> : <input type="text" value="00"/> |
| Schedule 8 (Purple) | Schedule mode Off |
| | <input type="checkbox"/> Mon <input type="checkbox"/> Tue <input type="checkbox"/> Wed <input type="checkbox"/> Thu <input type="checkbox"/> Fri <input type="checkbox"/> Sat <input type="checkbox"/> Sun Time range <input type="checkbox"/> 24h <input type="text" value="00"/> : <input type="text" value="00"/> - <input type="text" value="00"/> : <input type="text" value="00"/> |

Scene settings linked to sunrise and sunset times [To scene settings \(image quality adjustment\)](#)
 When using this function, set the time zone: [Basic settings.2.2](#)

Auto Scheduler (Manual/ City Selection)

Latitude

Longitude

Altitude

Automatic calculation result
 Sunrise time :
 Sunset time :

Sunrise time and sunset time correction
 Sunrise time + Minutes (-60 - 60)
 Sunset time + Minutes (-60 - 60)
 The time of the automatic calculation result can be corrected between -60 minutes and +60 minutes.

| | 0:00 | 6:00 | 12:00 | 18:00 | 24:00 |
|-----|------|------|-------|-------|-------|
| Mon | | | | | |
| Tue | | | | | |
| Wed | | | | | |
| Thu | | | | | |
| Fri | | | | | |
| Sat | | | | | |
| Sun | | | | | |

The color of each schedule is not linked with the area color of "VMD area".
 When "VMD permission" is set, the VMD functions in all the areas set with "VMD area".
 "VMD permission", "SCD permission" and "Auto track permission" are required to be set to specify a period of time where detection or tracking is to be performed. They are not required to be set when detection or tracking is to be performed regularly.
 "Auto mode (auto track)" and "Auto track menu" on the "Live" page are available even when it is out of the period specified in "Auto track permission".
 If the camera direction is changed by other operation while the setting of preset position, auto pan, preset sequence or patrol is being performed, the camera will automatically move back to the previous preset position and resume the operation in 1 minute.

Set

- 4 In [Schedule], tick the Day of the week boxes in which you want to schedule.
The day of the week is enabled.
- 5 To specify the time, click [▼] to specify the time.
If you do not specify a time zone, tick [24h].
- 6 When you are finished, press [Set].
The contents set at the bottom of the screen are displayed.

15 [Schedule] for scheduling
 15.1 How to set the schedule

Schedule

Schedules

| | | | |
|----------------------------|-------------------------------------------------|---------------------------------------------------------------------------------------------------------------------------------------------------------------------------------------------------------------------------------------------------------------------------------------------------------------------------------------------------------------------------------------------------------------------------------------------------------------|--|
| Schedule 1 (White) | Schedule mode VMD permission | <input checked="" type="checkbox"/> Mon <input checked="" type="checkbox"/> Tue <input checked="" type="checkbox"/> Wed <input checked="" type="checkbox"/> Thu <input checked="" type="checkbox"/> Fri <input checked="" type="checkbox"/> Sat <input checked="" type="checkbox"/> Sun <input type="checkbox"/> 24h <input type="text" value="09"/> : <input type="text" value="00"/> - <input type="text" value="17"/> : <input type="text" value="00"/> | |
| Schedule 2 (Blue) | Schedule mode VMD permission | <input checked="" type="checkbox"/> Mon <input checked="" type="checkbox"/> Tue <input checked="" type="checkbox"/> Wed <input checked="" type="checkbox"/> Thu <input checked="" type="checkbox"/> Fri <input checked="" type="checkbox"/> Sat <input checked="" type="checkbox"/> Sun <input type="checkbox"/> 24h <input type="text" value="23"/> : <input type="text" value="00"/> - <input type="text" value="07"/> : <input type="text" value="00"/> | |
| Schedule 3 (Green) | Schedule mode FTP/SFTP periodic image transi | <input type="checkbox"/> Mon <input type="checkbox"/> Tue <input type="checkbox"/> Wed <input type="checkbox"/> Thu <input type="checkbox"/> Fri <input checked="" type="checkbox"/> Sat <input checked="" type="checkbox"/> Sun <input type="checkbox"/> 24h <input type="text" value="00"/> : <input type="text" value="00"/> - <input type="text" value="00"/> : <input type="text" value="00"/> | |
| Schedule 4 (Red) | Schedule mode Off | <input type="checkbox"/> Mon <input type="checkbox"/> Tue <input type="checkbox"/> Wed <input type="checkbox"/> Thu <input type="checkbox"/> Fri <input type="checkbox"/> Sat <input type="checkbox"/> Sun <input type="checkbox"/> 24h <input type="text" value=""/> : <input type="text" value=""/> - <input type="text" value=""/> : <input type="text" value=""/> | |
| Schedule 5 (Black) | Schedule mode Off | <input type="checkbox"/> Mon <input type="checkbox"/> Tue <input type="checkbox"/> Wed <input type="checkbox"/> Thu <input type="checkbox"/> Fri <input type="checkbox"/> Sat <input type="checkbox"/> Sun <input type="checkbox"/> 24h <input type="text" value=""/> : <input type="text" value=""/> - <input type="text" value=""/> : <input type="text" value=""/> | |
| Schedule 6 (Yellow) | Schedule mode Off | <input type="checkbox"/> Mon <input type="checkbox"/> Tue <input type="checkbox"/> Wed <input type="checkbox"/> Thu <input type="checkbox"/> Fri <input type="checkbox"/> Sat <input type="checkbox"/> Sun <input type="checkbox"/> 24h <input type="text" value=""/> : <input type="text" value=""/> - <input type="text" value=""/> : <input type="text" value=""/> | |
| Schedule 7 (Light blue) | Schedule mode Off | <input type="checkbox"/> Mon <input type="checkbox"/> Tue <input type="checkbox"/> Wed <input type="checkbox"/> Thu <input type="checkbox"/> Fri <input type="checkbox"/> Sat <input type="checkbox"/> Sun <input type="checkbox"/> 24h <input type="text" value=""/> : <input type="text" value=""/> - <input type="text" value=""/> : <input type="text" value=""/> | |
| Schedule 8 (Purple) | Schedule mode Off | <input type="checkbox"/> Mon <input type="checkbox"/> Tue <input type="checkbox"/> Wed <input type="checkbox"/> Thu <input type="checkbox"/> Fri <input type="checkbox"/> Sat <input type="checkbox"/> Sun <input type="checkbox"/> 24h <input type="text" value=""/> : <input type="text" value=""/> - <input type="text" value=""/> : <input type="text" value=""/> | |

Scene settings linked to sunrise and sunset times [To scene setting \(image quality adjustment\)](#)
 When using this function, set the time zone. [Basic settings >>](#)

Auto Scheduler (Manual/ City Selection)

Latitude (-90.000000 - 90.000000)

Longitude (-180.000000 - 180.000000)

Altitude m (-500 - 9000)

Automatic calculation result
 Sunrise time :
 Sunset time :

Sunrise time + Minutes (-60 - 60)
 Sunset time + Minutes (-60 - 60)
 The time of the automatic calculation result can be corrected between -60 minutes and +60 minutes.

The color of each schedule is not linked with the area color of "VMD area".
 When "VMD permission" is set, the VMD functions in all the areas set with "VMD area"
 "VMD permission", "SCD permission" and "Auto track permission" are required to be set to specify a period of time where detection or tracking is to be performed. They are not required to be set when detection or tracking is to be performed regularly.
 "Auto mode (auto track)" and "Auto track from the right-click menu" on the "Live" page are available even when it is out of the period specified in "Auto track permission".
 If the camera direction is changed by other operation while the setting of preset position, auto pan, preset sequence or patrol is being performed, the camera will automatically move back to the previous preset position and resume the operation in 1 minute.

15.2 How to Delete Schedule

- 1 Uncheck the Day of the week box in which you want to delete the schedule.
- 2 When you are finished, press [Set].
The schedule for the selected day of the week is deleted.

15 [Schedule] for scheduling
 15.2 How to Delete Schedule

Schedule

Schedules

| | | |
|----------------------------|----------------------|--------------------------------------------------------------------------------------------------------------------------------------------------------------------------------------------------------------------------------------------|
| Schedule 1 (White) | Schedule mode Off | <input type="checkbox"/> Mon <input type="checkbox"/> Tue <input type="checkbox"/> Wed <input type="checkbox"/> Thu <input type="checkbox"/> Fri <input type="checkbox"/> Sat <input type="checkbox"/> Sun <input type="checkbox"/> 24h |
| Schedule 2 (Blue) | Schedule mode Off | <input type="checkbox"/> Mon <input type="checkbox"/> Tue <input type="checkbox"/> Wed <input type="checkbox"/> Thu <input type="checkbox"/> Fri <input type="checkbox"/> Sat <input type="checkbox"/> Sun <input type="checkbox"/> 24h |
| Schedule 3 (Green) | Schedule mode Off | <input type="checkbox"/> Mon <input type="checkbox"/> Tue <input type="checkbox"/> Wed <input type="checkbox"/> Thu <input type="checkbox"/> Fri <input type="checkbox"/> Sat <input type="checkbox"/> Sun <input type="checkbox"/> 24h |
| Schedule 4 (Red) | Schedule mode Off | <input type="checkbox"/> Mon <input type="checkbox"/> Tue <input type="checkbox"/> Wed <input type="checkbox"/> Thu <input type="checkbox"/> Fri <input type="checkbox"/> Sat <input type="checkbox"/> Sun <input type="checkbox"/> 24h |
| Schedule 5 (Black) | Schedule mode Off | <input type="checkbox"/> Mon <input type="checkbox"/> Tue <input type="checkbox"/> Wed <input type="checkbox"/> Thu <input type="checkbox"/> Fri <input type="checkbox"/> Sat <input type="checkbox"/> Sun <input type="checkbox"/> 24h |
| Schedule 6 (Yellow) | Schedule mode Off | <input type="checkbox"/> Mon <input type="checkbox"/> Tue <input type="checkbox"/> Wed <input type="checkbox"/> Thu <input type="checkbox"/> Fri <input type="checkbox"/> Sat <input type="checkbox"/> Sun <input type="checkbox"/> 24h |
| Schedule 7 (Light blue) | Schedule mode Off | <input type="checkbox"/> Mon <input type="checkbox"/> Tue <input type="checkbox"/> Wed <input type="checkbox"/> Thu <input type="checkbox"/> Fri <input type="checkbox"/> Sat <input type="checkbox"/> Sun <input type="checkbox"/> 24h |
| Schedule 8 (Purple) | Schedule mode Off | <input type="checkbox"/> Mon <input type="checkbox"/> Tue <input type="checkbox"/> Wed <input type="checkbox"/> Thu <input type="checkbox"/> Fri <input type="checkbox"/> Sat <input type="checkbox"/> Sun <input type="checkbox"/> 24h |

Scene settings linked to sunrise and sunset times [To scene setting \(image quality adjustment\)](#)
 When using this function, set the time zone [Basic settings >>](#)

Auto Scheduler (Manual/ City Selection) Not use

Latitude (-90.000000 - 90.000000)
 Longitude (-180.000000 - 180.000000)
 Altitude m(-500 - 9000)

Automatic calculation result
 Sunrise time :
 Sunset time :

Sunrise time and sunset time correction
 Sunrise time + Minutes (-60 - 60)
 Sunset time + Minutes (-60 - 60)
The time of the automatic calculation result can be corrected between -60 minutes and +60 minutes.

| | 0:00 | 6:00 | 12:00 | 18:00 | 24:00 |
|-----|------|------|-------|-------|-------|
| Mon | | | | | |
| Tue | | | | | |
| Wed | | | | | |
| Thu | | | | | |
| Fri | | | | | |
| Sat | | | | | |
| Sun | | | | | |

The color of each schedule is not linked with the area color of "VMD area".
 When "VMD permission" is set, the VMD functions in all the areas set with "VMD area"
 "VMD permission", "SCD permission" and "Auto track permission" are required to be set to specify a period of time where detection or tracking is to be performed. They are not required to be set when detection or tracking is to be performed regularly.
 "Auto mode (auto track)" and "Auto track from the right-click menu" on the Live page are available even when it is out of the period specified in "Auto track permission".
 If the camera direction is changed by other operation while the setting of preset position, auto pan, preset sequence or patrol is being performed, the camera will automatically move back to the previous preset position and resume the operation in 1 minute.

Set

15.3 How to change the image quality based on the time of sunrise/sunset

- 1 You can set the time of Sunrise and Sunrise from [Set scenes linked to Sunrise and Sunrise time].

[To scene setting (image quality adjustment)]

This is a link to the image quality adjustment for scene setting.

[Basic settings]

This is a link to the basic settings for setting the time zone.

[Auto Scheduler (Manual/City Selection)]

Select the input method for [Latitude], [Longitude], and [Altitude].

[Not used]: Disable operation mode [Auto Schedule] Daytime: Image Quality 1 / Night: Image Quality 2].

[Manual]: Manually enter [Latitude], [Longitude], and [Altitude].

[City name]: Displays a list of cities. The [Latitude], [Longitude], and [Altitude] of the selected city are entered and used for [Automatic calculation result].

[Latitude]

Enter the latitude of the region of the camera you are using.

Input range: -180 to 180 (valid up to 6 decimal places)

[Longitude]

Enter the longitude of the region of the camera you are using.

Input range: -90 to 90 (valid up to 6 decimal places)

[Altitude]

Enter the altitude of the region of the camera you are using.

If left blank, it will be calculated as "10m".

Input range: -500 to 9000 (m)

[Automatic calculation result]

The sunrise/sunset time is calculated from [Latitude], [Longitude], and [Altitude].

If you do not click the [Set] button, the calculation result will not be applied.

[Sunrise time and sunset time correction]

Perform time correction on the sunrise/sunset times in [Automatic calculation result] to determine the time applied for the image quality.

Input range: -60 to 60 (minutes)

- 2 Click the [Set] button.

15 [Schedule] for scheduling

15.3 How to change the image quality based on the time of sunrise/sunset

3 Configure the schedule. Please refer to the following for the setting method.

→[15.1 How to set the schedule](#)

16 [Maintenance] to maintain the machine

The Maintenance page checks the system log, software upgrades, checks the status, and initializes the computer.

The Maintenance page consists of the [System log], [Upgrade], [Status], [Default reset], and [Data] tabs.



[Note:]

- The items that can be set differ depending on the function of the model.
- Refer to the catalog specifications for the functions installed in each model.

16.1 [System log] to check the system logs

Click [System log] in the Maintenance page. Refer to the following how to display and operate the Advanced menu.

→5.1 [How to display](#)

→5.2 [How to operate](#)

If [SD memory card] is set to [Use] and an SD Memory Card is installed on your computer, up to 4000 system logs can be saved in the SD Memory Card.

→8.2 [\[SD memory card\] for setting SD Memory Cards](#)

If [SD memory card] is set to [Not use], up to 100 system logs can be saved in the computer's internal memory.

If the maximum number of system logs that can be saved is exceeded, the log is overwritten from the old log.

100 system logs are displayed and the logs are saved even if the camera is turned off.

[<<Latest 100 items

Click to display the list of the latest 100 system logs.

Next 100 items>>]

Click to display the following 100 items in the displayed system log list.

16 [Maintenance] to maintain the machine

16.2 [Upgrade] to upgrade the software

[Page number display]

The currently open page is displayed in the form [Page/Total Page].

[<<Previous 100 items]

Click to display 100 items in front of the displayed system log.

[No]

The serial number in the system log is displayed.

[Time & date]

The date and time when the log occurred is displayed.



[Note:]

- If [Time display format] is set to [24h], the logging date and time will be displayed in 24-hour format.

[Description]

The contents of the system log are displayed.

For details on the contents of each system log, refer to the following.

→[18.1 System Log Display](#)

16.2 [Upgrade] to upgrade the software

Click [Upgrade] in the Maintenance page. Refer to the following how to display and operate the Advanced menu.

→[5.1 How to display](#)

→[5.2 How to operate](#)

Here, you can review the software version and update the software to the latest version.

Contact your dealer for software for upgrading.

[Model no.], [MAC address], [Serial no.], [Firmware version], [IP address(IPv6)], [Time past from the date of manufacture]

Individual information on the computer is displayed.



[Note:]

- [MULTI_PTZ] [MAC address], [Firmware version], and [IP address(IPv6)] of the PTZ camera and Multi-directional camera are displayed.

1 Contact your dealer and download the latest software to the hard disk of your PC.



[Important]

- Do not use space or double-byte characters in the save directory.

2 Click [Select File] to specify the software that was downloaded.



[Note:]

- The latest version of the software is available on our technical information website.
https://i-pro.com/products_and_solutions/en/surveillance/documentation-database

3 Click the radio button to select whether to initialize the data after the version upgrade has been completed.



[Note:]

- Note that the set data cannot be restored after initialization.

4 Press [Execute].

The confirmation screen for executing the version upgrade is displayed.



[Important]

- After upgrading, be sure to check the version on this page.
- After upgrading, be sure to delete the temporary Internet file.
→ [18.2 Trouble!?](#)
- Use a PC on the same subnet as the machine to upgrade the version.
- When using the version upgrade software, be sure to check the precautions at the dealer where you purchased the software and follow the instructions.
- Use our specified img file for the software to be used to upgrade the version. Be sure to use [Model name _xxxxx.img] (model name is lowercase and [WV-] is not required) as the file name of the software to be used for version upgrading.

*[xxxxxx] contains the software version.

- Do not turn off the computer during version upgrading.
- Do not perform any operation during version upgrading until the version upgrade is completed.
- The following data will not be initialized even if [Initialize setup data after version upgrade is completed] is selected.

IPv4 DNS primary server address, secondary server address, IPv6 primary server address, DNS secondary server address, DHCP On/Off, IP address, subnet mask, default gateway, HTTP port, HTTPS port, HTTP/HTTPS connection method, CRT key, CA certificate, UPnP setting, communication rate, delivery rate control (bit rate), time setting, IEEE802.1X setting, function extension software, and function extension software setting

16.3 [Status] for checking the status

Click [Status] in the Maintenance page. Refer to the following how to display and operate the Advanced menu.

→5.1 [How to display](#)

→5.2 [How to operate](#)

Here, you can check the status of the machine.



[Note:]

- Please refer to our technical information website <Control No. C0111> for the contents of the status display.

[Viewnetcam.com]

[Server]

The URLs for the [Viewnetcam.com] services server are displayed.

[Status]

This box indicates the registered status of [Viewnetcam.com] services.

[Personal(Camera) URL]

The URLs of cameras registered for the [Viewnetcam.com] services are displayed.

Image transmission

[Image transmission log]

Click the [Confirm] button, to display the image transmission log in a separate window.

If [SD memory card] is set to [Use] and an SD Memory Card is installed on your computer, up to 4000 image transmission logs can be saved in the SD Memory Card.

→8.2 [SD memory card] for setting SD Memory Cards

If [SD memory card] is set to [Not use], up to 200 image transmission logs can be saved in the computer's internal memory.

If the maximum number of image transmission logs that can be saved is exceeded, the log is overwritten from the old log.

100 image transmission logs are displayed and the logs are saved even if the camera is turned off.

[<<Latest 100 items

Click to display the list of the latest 100 image transmission logs.

Next 100 items>>]

Click to display the following 100 items in the displayed image transmission log list.

[Page number display]

The currently open page is displayed in the form [Page/Total Page].

[<<Previous 100 items

Click to display 100 items in front of the displayed image transmission log.

[No]

The serial number in the image transmission log is displayed.

[Time]

Time and date at the error occurrence will be displayed.

[Stream type]

The stream type (Stream(*), JPEG(*), SD memory card playback) of the image transmission logs will be displayed.

(*) displays the number.

[Connected user]

The user of the image transmission will be displayed.



[Note:]

- If [Off] is selected for [User auth.], [-] will be displayed.

[IP address]

The IP address of the image transmission will be displayed.

[Event]

Start requests, stop requests, and start errors (heavy access) of the image transmission will be displayed.



[Note:]

- A stop request may not be logged in the following cases.
 - When settings related to the stream are changed, such as the image mode, stream, or resolution
 - When moving to the setting screen from the Live image
 - When the Live image is closed
 - When the network is disconnected

UPnP

Port number (HTTP), port number (HTTPS)

The port number configured for port forwarding in UPnP is displayed.

[Status]

The state of the port forwarding is displayed.

[Router global address]

The global address of the router is displayed.

[Self check]

The hardware self-diagnosis results are displayed.



[Note:]

- If you set [Viewnetcam.com] in [DDNS] on the [Advanced] tab of the Network Page, the Network status is displayed.

[Operation information]

[Number of times of pan/tilt operation]

The number of PAN and TILT operations and the last replacement time are displayed.

Press the [Execute] button of the [Reset at the time of replacement] button to change the operation count to zero and the last replacement time is updated.

[Number of times of zoom/focus operation]

The number of ZOOM and FOCUS operations and the last replacement time are displayed.

Press the [Execute] button of the [Reset at the time of replacement] button to change the operation count to zero and the last replacement time is updated.

[Status]

The number of starts, energizing time, temperature sensor information, heater information, etc. are displayed.



[Note:]

- [PTZ] Only the PTZ camera is displayed as operation information.

Active ClearSight

[Active ClearSight]

Press the [Execute] button to operate the camera at high speed to remove adhered water droplets.



[Note:]

- [Rapid PTZ] [Active ClearSight] will appear only in Rapid PTZ Camera. Images may be distorted during [Active ClearSight] operation.

USB interface

[Status]

If you recognize that the Wi-Fi USB adapter for installation is connected to the USB port, the Wi-Fi USB adapter part number information is displayed. If it is not recognized, [Not use] is displayed.

[Disable]

To disable the Wi-Fi USB adapter for installation, press [Execute].

If you want to recognize the Wi-Fi USB adapter again, use the INITIAL SET button.

Initialize (refer to the WEB Guide for instructions on how to initialize using the INITIAL SET button).

**[Note:]**

- Only the models that the USB adapter can connect to are displayed.
- Refer to the catalog specifications for the functions installed in each model.

SD Memory Card**[Model no.]**

Displays the model number of the SD memory card. If the product number data acquisition fails, [Read error] is displayed. When the SD Memory Card is not used, [Not use] is displayed. Otherwise, [Unknown] is displayed.

[Serial no.]

Displays the SD Memory Card serial number. If the serial number is not obtained, [Unknown] is displayed.

[Remaining capacity]

Displays the remaining capacity and total capacity of the SD Memory Card. The [SD memory card] tab-SD Memory Card info [Remaining capacity] on the Basic Page and the displayed content are the same.

[Total use time]

Displays the energizing time of the machine with the SD Memory Card inserted. If it fails to acquire the operating hours, [Unknown] is displayed. The operating time is updated once an hour.

[Number of overwrite times]

Displays the total capacity of the SD Memory Card, the number of files written to the SD Memory Card by the camera, and the number of times of overwriting calculated from the file size. If the overwrite count fails, [Unknown] is displayed.

**[Note:]**

- The number of times of overwriting is an estimate calculated in the computer and may differ from the actual number of times of overwriting.
- If you use [SD memory card password lock] and the passwords of SD cards do not match, the above information will not be displayed.

[No.] [Time & date] [Description] of logs

Displays the SD Memory Card log.

| Classification | Form of label | Details of contents |
|----------------|---------------|------------------------------------------------|
| SD Memory | <SD>Format | The SD Memory Card was successfully formatted. |

| | | |
|------|-------------------------------------------------------------------------------------------------------------------|---------------------------------------------------------------------------------------------------------------------------------------------------------------------------------------------------------------------|
| Card | <SD>Format error | An error occurred in the SD Memory Card format. |
| | <SD>Recognition error | The SD Memory Card cannot be recognized correctly. |
| | <SD>Write error | An error occurred during write processing of the SD memory card. |
| | <SD>Read error | An error occurred during read processing of the SD Memory Card. |
| | <SD>Deletion error | An error occurred during deletion processing of the SD Memory Card. |
| | <SD>Files system error | An error occurred in the file system of the SD Memory Card. |
| | <SD>Other errors | Other errors have occurred on the SD Memory Card. |
| | <SD>The SD Memory Card recording continuity is wrong. Check the recording bit rate setting on the SD Memory Card. | Data is missing during write processing on the SD Memory Card. |
| | <SD>An error occurs in the SD Memory Card. Check the SD Memory Card status. | Data is continuously missing during write processing on the SD Memory Card. Confirm that the SD Memory Card is correctly recognized. If not, restart the computer or unplug the SD Memory Card and insert it again. |



[Important]

- To use this function correctly, format the SD Memory Card on your computer before using the SD Memory Card.
- The correct information may not be displayed on the SD Memory Card used on a computer other than this unit.
- Up to 30 SD Memory Card logs can be saved in the internal memory of this computer. If the maximum number of system logs that can be saved is exceeded, the log is overwritten from the old log.

16.4 [Default reset] to initialize and restart the computer

Click [Default reset] in the Maintenance page. Refer to the following how to display and operate the Advanced menu.

→5.1 [How to display](#)

→5.2 [How to operate](#)

Here, initialize the computer's setup data and restart the computer.

[Reset to the default(Except the network settings)]

When [Execute] is clicked, the computer settings are reset to default settings. However, the network-related settings are not initialized.

When the initialization operation is performed, the product cannot be operated for approximately 3 minutes.

[Load the default HTML files (setup menu).]

[Execute] returns HTML files to their defaults.

When the initialization operation is performed, the product cannot be operated for approximately 3 minutes.

[Reset to the default and load the default HTML files.]

Press [Execute] to reset the computer settings and HTML files to their default settings. However, the network-related settings are not initialized.

When the initialization operation is performed, the product cannot be operated for approximately 3 minutes.

[Reboot]

Press [Execute] to restart the computer. After restarting, the product cannot be operated for about two minutes as it was when the power was turned on.

[Position refresh]

Refresh the machine position. The position can be corrected if the camera is misaligned with the home position or preset position while the camera is in use or if the camera is misdirected while the camera is powered on.

When position refresh is performed, operation cannot be performed for approximately 2 minutes.



[Important]

- If you install the camera, the camera may be turned by mistake. When registering a preset after installation, it is recommended to perform position refresh.



[Note:]

- Please refer to the following for the network settings. Refer to the WEB Guide for the formatting method.
→ [14.1 Networking \[Network\]](#)
- When you select Alarm or Mail Notification function, if the SD Memory Card is not installed after restarting, you can notify the set [Destination E-mail address] or [Destination of notification].
→ [14.2.1 Set mail sending](#)
→ [12.12 \[Notification\] to set alarm notification](#)

16.5 [Data] to back up/restore configuration logs

Click [Data] in the Maintenance page. Refer to the following how to display and operate the Advanced menu.

→ [5.1 How to display](#)

→ [5.2 How to operate](#)

Here, you can back up/restore your computer's setup data, scene files, and save your log.

Backup

[Setup data]

You can back up the computer's settings to your computer by clicking [Execute].

[Scene file]

By clicking on [Execute], you can back up the scene file settings for your computer.

[Logs]

You can back up your computer's logs by clicking [Execute].



[Important]

- It takes a long time to create a backup file when backing up configuration data and logs.
- If the backup operation takes more than 10 minutes, a communication timeout may occur. At this time, the backup data may not have been obtained completely, so please complete it within 10 minutes. You can also check whether the correct data was obtained by restoring the acquired data. (excluding log data)

Restore

[Setup data]

Press the [Select File] button to select the file of the set data to be restored.

Click the radio button to select whether to restore the network settings at restore time.

When [Execute] is clicked, restores start. After the restore is completed, the system restarts. Do not operate the screen until the restore is completed.

Be sure to use [Model name.dat] (model name is lowercase and [WV-] is not required) as the file name of the setting data to be used for restore.



[Important]

- If it takes more than five minutes to restore the setting data, the restore may have failed due to the disconnection of the communication.
Restore the system again.



[Note:]

- Restore operations for setup data are not applied to IEEE 802.1X related settings.
- Restore operations for setup data are not applied to the following network related settings.
 - [Line speed]
 - [Transmission data volume control (Bit rate)]
- Restore operations for setup data are not applied to UPnP related settings.
- Restore operations for setup data are not applied to HTTPS related settings (including CA Certificate and CRT key).
- Restore operations for setup data are not applied to extension software related settings.

[Scene file]

Press the [Select File] button to select the file of the scene file setting data to be restored.

When [Execute] is clicked, restores start. Do not operate the screen until the restore is complete.

Be sure to use [Model name.txt] (model name is lowercase and [WV-] is not required) as the file name of the scene file data to be used for restore.

17 Viewing Our Support Website [Support]

The Support page contains our support information.

The support information is as follows.

Support information for security products can be found on our support website.

Note: If you are not connected to the Internet, it cannot be displayed.

- For use in Japan

https://i-pro.com/products_and_solutions/ja/surveillance/learning-and-support

- For use outside Japan

<https://i-pro.com/global/en/surveillance/training-support/support>

The [i-PRO Setup Tool (iCT)] provides total support from i-PRO product setup to maintenance, enabling customers to streamline their operations.

The following URLs can be downloaded free of charge. (Control No. C0133)

Note: If you are not connected to the Internet, it cannot be displayed.

- For use in Japan

https://i-pro.com/products_and_solutions/ja/surveillance/learning-and-support/knowledge-base/technical-information

- For use outside Japan

<https://i-pro.com/global/en/surveillance/training-support/support/technical-information>

Click [Refer here for OSS used with this product] to display the OSS license used.

18 Other

18.1 System Log Display

SMTP error indication

| Classification | Form of label | Details of error |
|-------------------|-------------------------------------------------|-----------------------------------------------------------------------------------------------------------------------------------------------------------------------------------------------------------------------|
| POP3 server error | Authentication error | <ul style="list-style-type: none">•The username and password may be incorrect. Check the mail settings again. |
| | Without finding a POP3 server | <ul style="list-style-type: none">•The IP address of the server may be incorrect. Reaffirm the server's IP address setting.•The POP3 server may be down. Contact your network administrator. |
| SMTP server error | SMTP authentication error | <ul style="list-style-type: none">•The username and password may be incorrect. Check the mail settings again. |
| | Failure to resolve mail server address from DNS | <ul style="list-style-type: none">•The DNS server might be specified incorrectly. Check the DNS settings again.•The DNS server might be down. Contact your network administrator. |
| | Without finding the SMTP server | <ul style="list-style-type: none">•The IP address of the server may be incorrect. Reaffirm the server's IP address setting.•The SMTP server might be down. Contact your network administrator. |
| Internal error | Other errors | <ul style="list-style-type: none">•There is a problem with the mail function. Check the mail settings again. |

Visual Net Error Indication

| Classification | Form of label | Details of error |
|-------------------|--------------------|------------------------------------------------------------------------------------------------------------------------------------------------------------------------------------------|
| Access test error | Access test failed | <ul style="list-style-type: none">•The router might not be configured for port forwarding. Enable the UPnP configuration by referring to your router's instruction manual. |

| | | |
|---------------------|-------------------------------------------------|---------------------------------------------------------------------------------------------------------------------------------------------------------------------------------------------------------------------------------------------------|
| Visual server error | Net server address cannot be resolved from DNS. | <ul style="list-style-type: none"> •The DNS server might be specified incorrectly. Check the DNS settings again. •The DNS server might be down. Please refer to the [Viewnetcam.com] website for information on failures. |
| Connection failure | No server response | <ul style="list-style-type: none"> •The server may appear to be down. Please refer to the [Viewnetcam.com] website for information on failures. |
| | Transfer error | |
| Internal error | Other errors | <ul style="list-style-type: none"> •It looks like you have a problem with the Net function. Reaffirm the setting of the Net. |

Dynamic DNS Update Error Display

| Classification | Form of label | Details of error |
|--------------------|---------------------------------------------|-------------------------------------------------------------------------------------------------------------------------------------------------------------------------------------------------------------|
| DDNS server error | Cannot resolve DDNS server address from DNS | <ul style="list-style-type: none"> •The DNS server might be specified incorrectly. Check the DNS settings again. •The DNS server might be down. Contact your network administrator. |
| Connection failure | No server response | <ul style="list-style-type: none"> •The DDNS server might be down. Contact the server administrator. |
| | Host registration with homonyms | <ul style="list-style-type: none"> •Hosts with the same name are registered on the DDNS server. Reaffirm the DDNS Update setting. |
| Internal error | Other errors | <ul style="list-style-type: none"> •A problem with the DDNS Update function has occurred. Reaffirm the DDNS Update setting. |

NTP error indication

| Classification | Form of label | Details of error |
|---------------------------------------|----------------------|---------------------------------------------------------------------------------------------------------------------------------------------------------------------------------------------------------------------|
| Connection failure | No server response | <ul style="list-style-type: none"> •The IP address of the server may be incorrect. Reaffirm the server's IP address setting. •The NTP server may be down. Contact the server administrator. |
| Internal error | Other errors | <ul style="list-style-type: none"> •Problems with the NTP function are occurring. Reaffirm the NTP settings. |
| Time synchronization success with NTP | Auto time correction | <ul style="list-style-type: none"> •Successful time adjustment. |

HTTPS logging

| Classification | Form of label | Details of contents |
|----------------|---------------|---------------------|
|----------------|---------------|---------------------|

| | | |
|-------|-----------------------------|-------------------------------------------------------|
| HTTPS | Generated signature request | •The creation of the signature request was completed. |
| | CA certificate installed | •The CA certificate installation is completed. |
| | CA certificate deleted | •The CA certificate has been deleted. |
| | Previous CRT keys applied | •Previous CRT keys were applied as CRT keys. |
| | CRT key generated | •CRT key generation completed. |

MQTT error indication

| Classification | Form of label | Details of contents |
|----------------|--------------------|------------------------------------------------------------------------------------------------------------------------------------------------------------|
| MQTT | Connection failure | •Failure to connect to the server, fail to validate the certificate, or disconnect (except for disconnection from the camera due to configuration changes) |
| | Notification error | •If Publish to the server fails |

Display for login

| Classification | Form of label | Details of contents |
|----------------|-------------------------|-----------------------------------------------------------------------------------------------------------------------------------------------------------------------------------------------------------------|
| Login | User name or IP address | •Displays the user name of the user logged in to the computer when user authentication is configured. •Displays the IP address of the user logged in to the computer when host authentication is configured. |

Error indication for login errors

| Classification | Form of label | Details of contents |
|----------------|---------------|---------------------------------------------------------------------------------------------------------------------------------------------------------------------------------------------------------------------------------------------------------------------------------------------------------------------------------------------------------------------------------------------------------------------------------------|
| Login failure | User name | •Displays the user name of the user who failed to log in to the computer when user authentication is configured. •If the user is not registered, the (unregistered user) is displayed. •The log for [Login failed] may remain during normal operation, but this is not an error in the camera. •If a large number of consecutive logs are retained, unauthorized access may be obtained. Contact your network administrator. |

Error indication for unique alarm notification

| Classification | Form of label | Details of error |
|-----------------------------------------------|---------------------------------------------------|----------------------------------------------------------------------------------------------------------------------------------------------------------------------------------------------------------------------------------------------------------------------------------|
| Original alarm notification destination error | Without notifying | <ul style="list-style-type: none"> The IP address of the notification destination may be incorrect. Confirm the setting of the IP address of the notification destination. The notification destination may be down. Contact your network administrator. |
| | Notification address cannot be resolved from DNS. | <ul style="list-style-type: none"> The DNS server might be specified incorrectly. Check the DNS settings again. The DNS server might be down. Contact your network administrator. |

Error indication for HTTP alarm notification

| Classification | Form of label | Details of error |
|-------------------------------------------|---------------------------------------------------|----------------------------------------------------------------------------------------------------------------------------------------------------------------------------------------------------------------------------------------------------------------------------------|
| HTTP alarm notification destination error | Without notifying | <ul style="list-style-type: none"> The IP address of the notification destination may be incorrect. Confirm the setting of the IP address of the notification destination. The notification destination may be down. Contact your network administrator. |
| | Notification address cannot be resolved from DNS. | <ul style="list-style-type: none"> The DNS server might be specified incorrectly. Check the DNS settings again. The DNS server might be down. Contact your network administrator. |
| | Authentication error | <ul style="list-style-type: none"> The username and password may be incorrect. Check whether the HTTP alarm is set correctly. |

Display of SD Memory Card Security

| Classification | Form of label | Details of contents |
|----------------|-----------------------------|--------------------------------------------------------------------------------------------------------|
| SD card | Generated signature request | <ul style="list-style-type: none"> The creation of the signature request was completed. |
| | CA certificate installed | <ul style="list-style-type: none"> The CA certificate installation is completed. |
| | CA certificate deleted | <ul style="list-style-type: none"> The CA certificate has been deleted. |

| | | |
|--|---------------------------|----------------------------------------------|
| | Previous CRT keys applied | •Previous CRT keys were applied as CRT keys. |
| | CRT key generated | •CRT key generation completed. |

Displaying firmware upgrades

| Classification | Form of label | Details of contents |
|------------------------|----------------------------|---------------------------------------------------------------------------------------------------|
| Upgrading the firmware | Successful version upgrade | •The firmware version is successfully upgraded and the firmware version (before/after) is logged. |

Error indication for firmware version upgrade

| Classification | Form of label | Details of contents |
|------------------------|--------------------------------------------------------------------------|----------------------------------------------------------------------------------------------------------------------------------------------------|
| Upgrading the firmware | Version upgrading failed (timeout: insufficient communication bandwidth) | •Farm-up failed due to timeout due to insufficient communication bandwidth. Confirm the communication environment and perform the procedure again. |
| | Failed version upgrading (file error: Incorrect firmware file selection) | •Farm-up failed because the wrong file was uploaded. Select the firmware of the computer and perform the test again. |
| | Version upgrading failure (Communication error: File corrupted) | •Firmup failed due to file corruption during firmware transfer. Confirm the communication environment and perform the procedure again. |
| | Upgrade failure (Signature verification failure) | •Farm-up failed because Firmware digital signature verification failed. Check that the firmware to be uploaded is correct, and try again. |
| | Version upgrade failure (Other error) | •Error occurred during firmware version upgrade. Wait for a while before starting the procedure again. |

Error indication for installation status

| Classification | Form of label | Details of contents |
|---------------------|---------------------------|----------------------------------------------------------------------------------------------------------------------|
| Installation status | Installation status error | •Error in installation was detected. Reaffirm the installation condition of the machine and turn on the power again. |

FTP/SFTP error indication

| Classification | Form of label | Details of contents |
|--------------------|------------------------------------------------|-----------------------------------------------------------------------------------------------------------------------------------------------------------------------------|
| Server error | Can't find a server | •The FTP/SFTP server might be down. Contact the server administrator. •The IP address of the FTP/SFTP server may be incorrect. Reaffirm the server's IP address setting. |
| | Failure to resolve FTP server address from DNS | |
| Connection failure | Username password error | •The FTP/SFTP server may be configured incorrectly. Reaffirm the settings. •Setting of each display may be incorrect. Reaffirm the settings. |
| | Failed to change directory | |
| | Host key collation error | |
| | Without access privileges | |
| | Image transmission failed | |
| | Transfer error | |
| | Error in Passive mode | |
| | Logout failure | |
| Internal error | Other errors | •There is a problem with the FTP/SFTP function. Check the FTP/SFTP settings again. |

18.2 Trouble!?

Check the symptoms on this table before asking for repair.

Contact the dealer from whom you purchased the watch if you do not recover from any of these problems or if you have symptoms other than those listed in this table.

| Phenomenon | Causes and countermeasures | Reference |
|------------|----------------------------|-----------|
|------------|----------------------------|-----------|

| | | |
|---------------------------|-------------------------------------------------------------------------------------------------------------------------------------------------------------------------------------------------------------------------------------------------------------------------------------------------------------------------------------------------------------------------------------------------------------------------------------------------------------------------------------------------------------------------------------------------------------------------------------------------------------------------------------------------------------------------------------------------------------------------------------------------------------------------------------------------------------------------------------------------------------------------------------------------------------------------------------------------------------------------------------------------------------------------------------------------------------------------------------------------------------------------------------------------------|-------------------------------------------|
| Cannot be accessed from a | <ul style="list-style-type: none"> •Are cables of category 5e or higher connected to the network connector? | Operation Manual Installation |
| Web browser | <ul style="list-style-type: none"> •Check that the link lamp (LINK) is illuminated. If it is not illuminated, the connection to the LAN is not normal or the network to which the connection is made is not operating normally. Check the cable for faulty contact and wiring. | Operation Manual Installation |
| | <ul style="list-style-type: none"> •Check that the power to the machine is ON and that the power to the machine is ON. | Operation Manual Installation |
| | <ul style="list-style-type: none"> •Are valid IP addresses set for your computer? | 14.1 Networking [Network] |
| | <ul style="list-style-type: none"> •Are incorrect IP addresses accessed? Confirm the connection using the following method. In the Windows command prompt>If Reply is returned from your computer under ping [IP address set for your computer], it is operating normally. If Reply is not returned, check the connection using the PC connected to the same network as the camera as shown below. If the firewall setting of the PC is enabled, temporarily cancel the firewall setting before setting the camera. <p>Start the IP Easy Configuration Software, check the camera IP address, and access the IP address. If the network configuration (IP address, subnet mask, default gateway) is incorrect, restart the camera and change the network configuration using the IP easy configuration software within 20 minutes.</p> <p>In an environment without a · DHCP server, restarting the computer with the Initialization button sets the IP address to [192.168.0.10(*)]. Then access the computer to reset the IP address (which initializes all settings).</p> <p>The IP address of the (*) Multi-directional/PTZ</p> | -- |

| | | |
|--|------------------------------------------------------------------------------------------------------------------------------------------------------------------------------------------------------------------------------------------------------------------------------------------------------------------------------------------------------------------------------------------------------------------------------------------------------------------------------------------------------------------------------------------------------|-------------------------------------------------------|
| | integrated camera is 192.168.0.10 for the PTZ camera and 192.168.0.11 for the Multi-directional camera. | |
| | •HTTP port numbers other than 20, 21, 22, 23, 25, 42, 53, 67, 68, 68, 69, 80, 110, 123, 161, 162, 443, 554, 995, 1883, 883, 10669, 10670, 59000–61000 should be used for HTTP port numbers. | 14.1 Networking [Network] |
| | •Is the set IP address overlapping with other devices? Is the set address and the destination network subnet conflicting? (If the computer and the PC are connected in the same subnet)? Is the set IP address of the computer and PC set to the same subnet? Also, if [Use Proxy Server] is not set on the PC, or if you are accessing the computer within the same subnet, it is recommended that the [Remove from proxy] address be set. If the computer is connected to a different subnet, is the default gateway set for the computer correct? | -- |
| | •Are you accessing the computer with a name that is different from the one registered in [Viewnetcam.com] (nickname)? Access the computer with the registered name. | 14.4.1 With [Viewnetcam.com] services |
| | •If HTTPS is used, access [http:///] while the HTTPS function is in use. You must also enter the port number. Please refer to the support video page of the support site<Control No. P0002>、<Control No. P0003>. | -- |

| Phenomenon | Causes and countermeasures | Reference |
|---------------------------------------------|-------------------------------------------------------------------------------------------------------------------------------------------------------------------------------------|-------------------------------------------|
| Camera cannot be accessed from the Internet | •Are the network settings for the computer correct? Configure the default gateway or DNS server address correctly. When using the DDNS service, make sure that it is set correctly. | 14.1 Networking [Network] |

| | | |
|--|---------------------------------------------------------------------------------------------------------------------------------------------------------------------------------------------------------------------------------------------------------------------------------------------------------------------------------------------------------------------------------------------------------------------------------------------------------------------------------------------------------------------------------------------------------------------------------------------------------------------------------------------------------------------------------------------------------|-----------------------------------------------------------------------------------------|
| | <ul style="list-style-type: none"> • In networking, do you configure [Default gateway]? Or do you configure it correctly? In IPv4, [Set]-[Network]-[IPv4 network], set [Default gateway] correctly. | |
| | <ul style="list-style-type: none"> • Does the router have a port forwarding configuration? If your router does not have UPnP capability, you must configure the port forwarding configuration to allow access to the computer from the Internet. Refer to your router's Instruction Manual for how to configure. • Is the UPnP function disabled on the router? Refer to the router's instruction manual and enable the UPnP function. • Does the router have packet filtering or other settings that prohibit access from the Internet? Enable your router to access from the Internet. Refer to your router's instruction manual for how to configure this function. | 14.2.4 Set UPnP |
| | <ul style="list-style-type: none"> • Do you have access to the IP address (local address) for use on the local network? Check the IPv4 network settings, IPv6 network settings, and DDNS settings, and access the global address (or URL registered with the DDNS service) as the IP address of the computer for use on the Internet with the computer's port number. | 14.1 Networking [Network] 14.4 How to configure DDNS |

| Phenomenon | Causes and countermeasures | Reference |
|--------------------------------------------------|---------------------------------------------------------------------------------------------------------------------------------------------------------------------------------------------------------------------------------------------------------------------------------------------------------------------------------------------------------------------------------------------------------------------------------------------------------------------|---------------------------------------------------------------------------------------------------------------------|
| Unaccessible with [Viewnetcam.com] services URLs | <ul style="list-style-type: none"> • Is the global address of the machine (or router) informed to the [Viewnetcam.com] service server? Check the registered cameras on the [Viewnetcam.com] service website. If not, please go to the computer and [Set]-[Network]-[Advanced] to complete the [Viewnetcam.com] services registrations. Also, check the [Viewnetcam.com] status and system logs for the [Set]-[Maintenance]-[Status] of the computer. | 14.4.1 With [Viewnetcam.com] services 16.1 [System log] to check the system logs |

| Phenomenon | Causes and countermeasures | Reference |
|------------------------------------------------|-----------------------------------------------------------------------------------------------------------------------------------------------------------------------------------------------------------------------------------------------------------------------------------------------------------------------------------------------------------------------------------------------------------------------------------------------------------------------|-----------|
| Display the authentication screen continuously | <ul style="list-style-type: none"> •If the user name or password has been changed while the computer is being accessed and the user name or password being logged in has been changed in another web browser, the authentication screen is displayed each time the screen is switched. Close the Web browser and access the computer again. •If you have changed the [Authentication method] setting, close the web browser and re-access it. | -- |

| Phenomenon | Causes and countermeasures | Reference |
|------------------------|------------------------------------------------------------------------------------------------------------------------------------------------------------------------------------------------------------------------------------------------------------------------------------|-----------|
| Take longer to display | <ul style="list-style-type: none"> •Are you accessing in HTTPS mode? In HTTPS mode, the display will be slow depending on the specifications of your PC for decoding processing. Refer to the web guide of your model for the recommended specifications of the PC. | -- |
| | <ul style="list-style-type: none"> •Do you have access to your computer on the same local network via a proxy? Configure the PC so that it does not go through a proxy. | -- |
| | <ul style="list-style-type: none"> •Are multiple users referring to the camera image at the same time? If multiple users refer to the camera image at the same time, the screen display may take longer or the camera image updating speed may be slower. | -- |

| Phenomenon | Causes and countermeasures | Reference |
|------------|----------------------------|-----------|
|------------|----------------------------|-----------|

| | | |
|----------------------------------------------------------|-------------------------------------------------------------------------------------------------------------------------------------------------------------------------------------------------------------------------------------------------------------------------------------------------------------------------------------------------------------------------------------------------------------------------------------------------------------------------------------------------------------------|----|
| Camera cannot be accessed from mobile or tablet terminal | <p>In the case of mobile devices:</p> <ul style="list-style-type: none"> •URL is wrong. Or, is [/cam] not entered at the end of the URL? Ensure that the URL is entered correctly. When accessing the computer from a portable terminal, enter [/cam] at the end of the URL to be used when accessing the computer from the PC. <p>For tablet terminals:</p> <ul style="list-style-type: none"> •Check that the URL is correct and that the URL is entered correctly. | -- |
| | <ul style="list-style-type: none"> •Is the SSL encryption method of the HTTPS of the mobile terminal or tablet terminal different from that of this device? Set the [Connection] of the HTTPS of this device to [HTTP] and re-access it. | -- |
| | <ul style="list-style-type: none"> •If HTTPS is used, access [http:///] while the HTTPS function is in use. You must also enter the port number. Please refer to the support video page of the support site<Control No. P0002>、<Control No. P0003>. | -- |

| Phenomenon | Causes and countermeasures | Reference |
|------------------------------------------------------------------------------------------------------------------------------------------------------------------------------------|------------------------------------------------------------------------------------------------------------------------------------------------------------------|-----------|
| When registering with [Viewnetcam.com] services, an error is displayed (e.g. [Error occurred. Cookie cannot be used or expired. Cookie available browser, reconnect by setting.]). | <ul style="list-style-type: none"> •Is the security setting of the web browser set to not accept cookies? Check the settings of your web browser. | -- |

| | | |
|--------------------------------------------|--------------------------------------------------------------------------------------------------------------------------------------------------------------------------------------------------------------------------------------------------------------------------------------------------------------------------------------------------------------|----|
| Fail to register [Viewnetcam.com] services | <ul style="list-style-type: none"> •Is there a possibility that the registered e-mail address is incorrect? If the e-mail containing the links to the [Viewnetcam.com] services website is not sent, the registered e-mail address may be incorrect? Refer to the [Viewnetcam.com] services website to register the e-mail address correctly. | -- |
|--------------------------------------------|--------------------------------------------------------------------------------------------------------------------------------------------------------------------------------------------------------------------------------------------------------------------------------------------------------------------------------------------------------------|----|

| Phenomenon | Causes and countermeasures | Reference |
|---------------------------------------------------------------------|----------------------------------------------------------------------------------------------------------------------------------------------------------------------------------------------------------------------------------------------------------|-------------------------------------------------------------------------------------------------------------------------------------|
| No Picture | <ul style="list-style-type: none"> •Please refer to the instruction manual for your mobile terminal/tablet terminal for information about the limitation of image data size that can be displayed on the mobile terminal/tablet terminal. | -- |
| Blur the image | <ul style="list-style-type: none"> •Check that the focus is adjusted correctly. | 9.4.5 Adjust the zoom/focus |
| The camera is not focused immediately after the power is turned on. | <ul style="list-style-type: none"> •Focus and zoom are adjusted after starting the camera, and the camera is out of focus for a certain period of time. | -- |
| The image is not updated | <ul style="list-style-type: none"> •Depending on the web browser or version, images may not be updated or other problems may occur. | Web Guide |
| | <ul style="list-style-type: none"> •Images may stop being displayed due to network congestion or concentration of access to the machine. Request the acquisition of images by pressing the [F5] key on the PC keyboard. | -- |
| The camera image is not displayed (dark). | <ul style="list-style-type: none"> •Is the [Brightness] set to darken? Click [Normal] for brightness. | 2.3.2 About live image pages |
| Look whitish | <ul style="list-style-type: none"> •Is the [Brightness] set to brighten? Click [Normal] brightness. <p>When the [Adaptive black stretch] slider bar is moved in the [-] direction, the image is darkened.</p> | 2.3.2 About live image pages 9.4.1 To adjust the image quality (image quality adjustment screen) |

| | | |
|-------------------|----------------------------------------------------------------------------------------------------------------------------|---------------------------------------------------------------------|
| Flicker the image | <ul style="list-style-type: none"> •If flickering is a concern, set [Light control mode] to [Indoor scene]. | 9.4.1 To adjust the image quality (image quality adjustment screen) |
|-------------------|----------------------------------------------------------------------------------------------------------------------------|---------------------------------------------------------------------|

| Phenomenon | Causes and countermeasures | Reference |
|-------------------------------------------------|------------------------------------------------------------------------------------------------------------------------------------------------------------------------------------------------------------------------------------------------|---------------------------------------------------------------------------|
| Image not saved on SD Memory Card | <ul style="list-style-type: none"> •Check that the SD Memory Card is mounted correctly and correctly. | -- |
| Failure to write to or read from SD Memory Card | <ul style="list-style-type: none"> •Is the SD Memory Card formatted? | -- |
| | <ul style="list-style-type: none"> •[-----MB] is displayed on the [Remaining capacity] of the [SD memory card] tab. Please format the SD Memory Card. | 8.2 [SD memory card] for setting SD Memory Cards |
| | <ul style="list-style-type: none"> •[Remaining capacity] of the [SD memory card] tabs#####MB/#####MB is not displayed? Check the password lock setting. | 8.2 [SD memory card] for setting SD Memory Cards |
| | <ul style="list-style-type: none"> •If the mail notification or unique alarm [Diag.] function is used, has the recognition error of the SD Memory Card been received? | 8.2 [SD memory card] for setting SD Memory Cards |
| | <ul style="list-style-type: none"> •In the [Maintenance]-[Status]-[SD memory card] logs<SD>Is the recognition error displayed? Format the SD Memory Card. | 12.12 [Notification] to set alarm notification 14.2.1 Set mail sending |
| | <ul style="list-style-type: none"> •Is the SD Memory Card faulty? The SD Memory Card has a limited number of rewrites. Replace the SD Memory Card with a new one if it is rewritten frequently because it may last a long time. | -- |

| Phenomenon | Causes and countermeasures | Reference |
|--------------------------------|-----------------------------------------------------------------------------------------------------------------------------------------------------------------------------------------------------------|--------------------------------|
| Inability to communicate voice | <ul style="list-style-type: none"> •Check that the microphone and speakers are connected correctly and correctly. •Transmission voice can only be used when connected with HTTPS. | Operator's Manual Installation |

| | | |
|---------------------------------------------------------------------|--------------------------------------------------------------------------------------------------------------------------------------------------------------------------------------------------------------------|-----------------------------------------------|
| Without audio from our network disk recorder or PC software package | <ul style="list-style-type: none"> Some of our network disk recorders and PC software packages do not support [G.711]. Set the earpiece speech compression method to [G.726 (32 kbps)] or [AAC-LC]. | 9.5 [Audio] for setting sound |
| The image on the live image page is not displayed. | <ul style="list-style-type: none"> Press the [F5] key on the PC keyboard or press the [Live] button. | 2.3 Viewing images from a PC |
| The shortcut icon for the camera is not displayed on the [Network]. | <ul style="list-style-type: none"> Does the UPnP Windows component have been added? Add the UPnP Windows component to your PC? | 14.2.4 Set UPnP |

| Phenomenon | Causes and countermeasures | Reference |
|----------------------------------------------------------------------------------|-----------------------------------------------------------------------------------------------------------------------------------------------------------------------------------------------------------------------------------------------|-----------------------------------------------------------------------------------------------------------|
| Image not updated or displayed successfully | <ul style="list-style-type: none"> The port of this equipment may have been filtered by the firewall function of the virus check software. Change the HTTP port number of your computer to a port number that is not filtered. | -- |
| The lamps are not lit. | <ul style="list-style-type: none"> In the Advanced menu [Basic], is the lamp display setting set to [Off]? Set the lamp display setting to [On]. | 8.1 [Basic] to perform basic settings |
| The H.265 (or H.264) image does not appear smoothly. | <ul style="list-style-type: none"> The following may be improved. Check the [Required PC Environment] in the web guide. | Web Guide |
| Clicking the Back button on the Web browser will not display the correct screen. | <ul style="list-style-type: none"> Press the [F5] key on the PC keyboard to update the screen. | -- |
| [Access is concentrated. Run later.] is displayed on the live picture page. | <ul style="list-style-type: none"> Change the [Bit Rate* per Client] setting of the stream to a lower value. Change the [Initial display stream] setting to the lower [Max bit rate (per client) *] streams. | 9.3 [Image] for setting up streams 9.2 [Image] for setting JPEG images |

| | | |
|-----------------------------------------------------------------------------------------------------------------------------------|-----------------------------------------------------------------------------------------------------------------------------------------------------------------------------------------------|----|
| A dialog message, error message, or other character in the message will break, or a portion of the message will not be displayed. | •This may be canceled by changing the settings of the PC. Right-click the PC screen and change the display by clicking [Display Settings] → [Change the size of text, apps, and other items]. | -- |
|-----------------------------------------------------------------------------------------------------------------------------------|-----------------------------------------------------------------------------------------------------------------------------------------------------------------------------------------------|----|

18.3 Directory structure of SD Memory Card

18.3.1 Directories of PTZ Camera, Fixed cameras

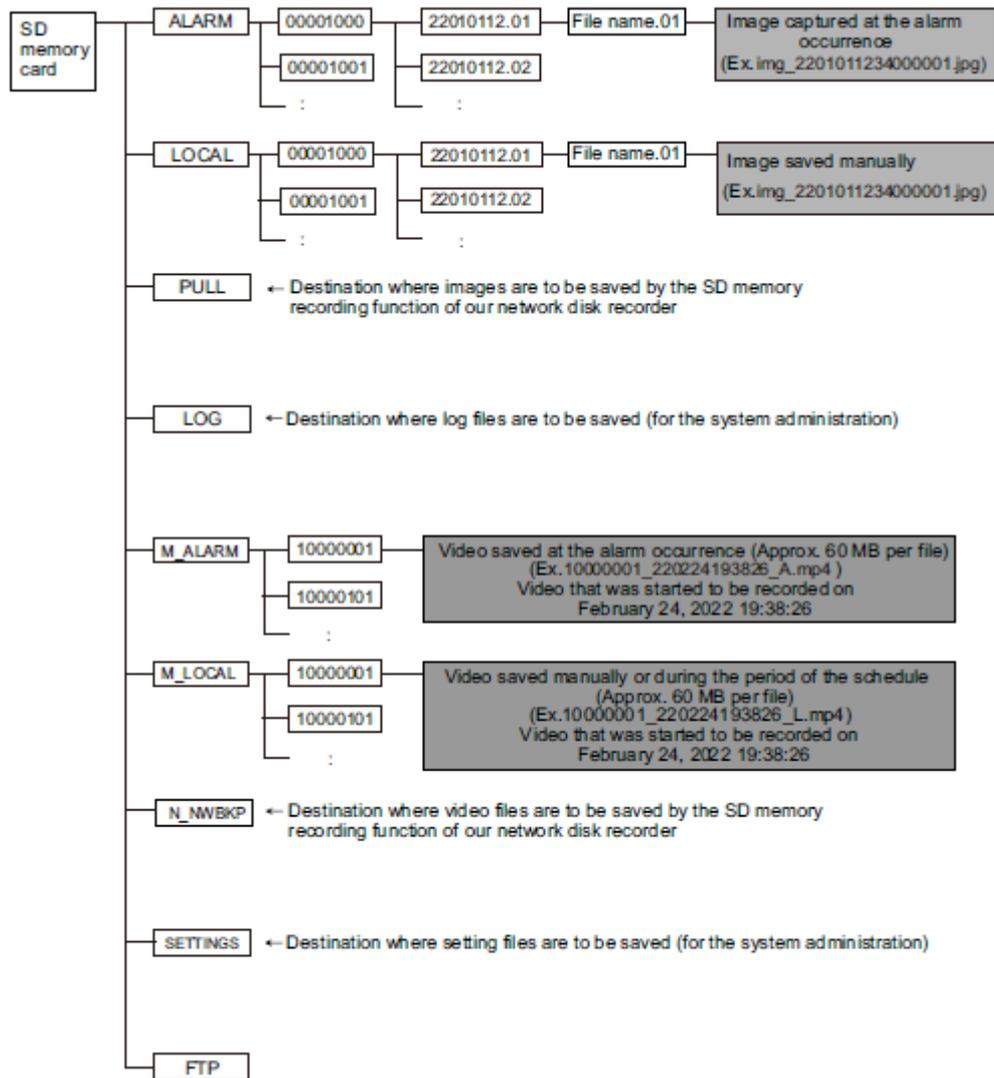

18.3.2 Directory Configuration of Multi-directional Camera

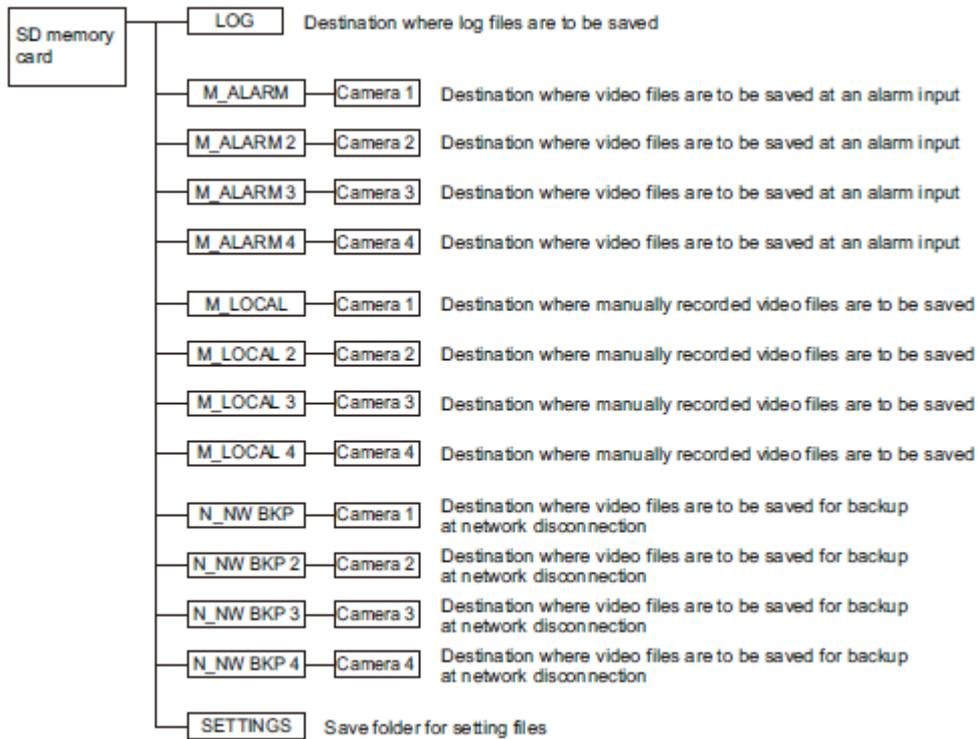

19 Change history

Ver 1.000.000 (2023.02.15)

Add new product

Multi-directional + PTZ Camera

WV-X86531-Z2, WV-X86530-Z2

Ver 1.001.000 (2023.03.08)

Add new product

Multi-directional dual sensor camera

WV-S85702-F3L, WV-S85402-V2L, WV-U85402-V2L

Ver 1.002.000 (2023.09.12)

Add new product

Mini Box Sphere IR-PTZ

WV-S66700-Z3L, WV-X66700-Z3LS, WV-S66700-Z3, WV-X66700-Z3S

WV-S66600-Z3L, WV-X66600-Z3LS, WV-S66600-Z3, WV-X66600-Z3S

WV-S66300-Z4L, WV-X66300-Z4LS, WV-S66300-Z3L, WV-X66300-Z3LS

WV-S66300-Z4, WV-X66300-Z4S, WV-S66300-Z3, WV-X66300-Z3S

New compact dome

WV-X35402-F2L, WV-X35302-F2L

WV-S35402-F2L, WV-S32402-F2L, WV-S35302-F2L, WV-S32302-F2L

New functions and addendum (Firmware Ver.2.33)

- The following was added to the communication protocol FTP/SFTP function of the file transfer function. (→[14.2.2 Configuring FTP/SFTP transmission function](#))
 - Add 2fps, 3fps to Image-Update Rate
 - Add 1920x1080 to Image capture size for pre-alarm
 - Expand image destination server to two locations

- A 0.5s, 1s, 2s, 3s, 4s was added to the alarm absence detection period. (→[12.1 \[Alarm\] to set alarm operation](#))
- The function to change the image quality at the time of sunrise and sunset has been added to the schedule setting. (→[15 \[Schedule\] for scheduling](#))
- Added the [Enable/Disable] setting for [SNMP] in the [Advanced] tab of the Network page. (→[14.2.7 Set SNMP](#))
- You can now edit the camera title by adding and clicking the title edit icon next to the camera title. (→[2.3 Viewing images from a PC](#))
- You can now select [SD Memory Card File System Format] and [FAT(FAT16/FAT32/exFAT)] and [ext(ext4)] to select the file system format of the SD memory card. (→[8.2 \[SD memory card\] for setting SD Memory Cards](#))

Ver 1.003.000 (2023.09.29)

New functions and addendum (Firmware Ver.2.40)

- Add 1280x720 image capture size for Stream (1) and Stream (2) of the Multi-directional sensor camera 4MP model.(→[9.3 \[Image\] for setting up streams](#))
- The information in the notes has been changed due to the relaxation of frame rate restrictions during [GOP control].(→[9.3 \[Image\] for setting up streams](#))
- The note description has been changed because the tracking performance of the auto track function may lower depending on the [Maximum shutter] setting.(→[10.3 Set auto-tracking \(Auto-tracking screen\)](#))
- A note description has been added regarding function settings that are not applied when settings data is restored.(→[16.5 \[Data\] to back up/restore configuration logs](#))

Ver 1.004.000 (2023.12.15)

Add new product

New compact dome

WV-U35401-F2L, WV-U35301-F2L

WV-U31401-F2L, WV-U31301-F2L

Ver 1.005.000 (2023.12.26)

Add new product

New X Fixed cameras

WV-X15300-V3L, WV-X15300-V3LN, WV-X22300-V3L, WV-X25300-V3LN

WV-X15600-V2L, WV-X15600-V2LN, WV-X22600-V2L, WV-X25600-V2LN

WV-X15700-V2L, WV-X15700-V2LN, WV-X22700-V2L, WV-X25700-V2LN

Ver 1.006.000 (2024.02.27)

New functions and addendum (Firmware Ver.2.50/[New X Fixed] Ver.3.10)

- A SAN entry field has been added to the CSR creation screen.(→[14.3 Setting up HTTPS](#))
- The initial password for data encryption has been changed to blank.(→[13.5 \[Data encryption\] for setting up data encryption](#))
- The names of connection options for HTTP and HTTPS have been changed. [TLS1.2] has been changed so that it can now be enabled or disabled.(→[14.2.5 Set up HTTPS](#))
- A "Diag." function has been added to HTTP alarm notifications.(→[12.12.2 Set the HTTP alarm notification](#))
- The [Security] settings screen has been added to the [User mng.] menu. Settings related to security can be configured in this section.(→[13.6 \[Security\] to configure security](#))
- "MD5" has been removed from the SNMPv3 [Authentication].(→[14.2.7 Set SNMP](#))
- "EAP-MD5" has been removed from the [EAP method] for IEEE 802.1X.(→[13.4 \[IEEE 802.1X\] to configure IEEE 802.1X](#))

Ver 1.007.000 (2024.03.18)

Add new product

New X Fixed cameras

WV-X15500-V3L, WV-X15500-V3LN, WV-X22500-V3L, WV-X25500-V3LN

Ver 1.008.000 (2024.05.27)

New functions and addendum (Firmware Ver.2.60/[New X Fixed] Ver.3.20)

- In order to change the font of the live image screen and i-PRO logo design, a description has been added to the announcement.(→[2.3.2 About live image pages](#))

Ver 1.009.000 (2024.05.28)

Add new product

Mini Box Sphere IR-PTZ(ClearSight coating model)

WV-S66700-Z3LN, WV-X66700-Z3LK, WV-S66700-Z3N, WV-X66700-Z3K

WV-S66600-Z3LN, WV-X66600-Z3LK, WV-S66600-Z3N, WV-X66600-Z3K

WV-S66300-Z4LN, WV-X66300-Z4LK, WV-S66300-Z3LN, WV-X66300-Z3LK

WV-S66300-Z4N, WV-X66300-Z4K, WV-S66300-Z3N, WV-X66300-Z3K

Ver 1.010.000 (2024.08.06)

Add new product

Corner cameras

WV-X25580-F2LN2

Ver 1.011.000 (2024.10.23)

Add new product

Indoor PTZ cameras

WV-S61702-Z3, WV-S61602-Z3

Ver 1.012.000 (2024.10.25)

New functions and addendum (Firmware Ver.2.70/[New X Fixed] Ver.3.30)

- Due to the change of icons, the images on the live image screen have been replaced.
 - (→2.1 [Initial Setting](#))
 - (→2.2 [Initial setting \(Multi-directional/PTZ integrated camera\)](#))
 - (→2.3.2.1 [Live image pages of Fixed Cameras](#))
 - (→2.3.2.2 [Live image pages of the PTZ camera](#))
 - (→2.3.2.3 [Live image pages of Multi-directional Cameras](#))
 - (→2.3.2.4 [Live image pages of Multi-directional/PTZ integrated cameras](#))
 - (→2.3.3 [Monitor images from multiple cameras](#))
 - (→2.7 [Display the log list](#))
 - (→2.8.1 [When playing JPEG images stored on the SD Memory Card](#))
 - (→2.8.2 [Play back the image of the stream stored on the SD Memory Card](#))
 - (→13.5 [\[Data encryption\] for setting up data encryption](#))

- The setting window for connecting Remote Monitoring was added to "Remote Monitoring" of "Network".(→[14.5 Use Remote Monitoring](#))