

### Overview

- 4 Megapixel IR
- True WDR 120dB
- 2.8mm Fixed Lens
- H.265, H.264, MJPEG
- Support 9:16 Corridor Mode
- IP67
- Built-in Mic & Speaker
- NDAA Compliant
- ONVIF Profile G, S, T







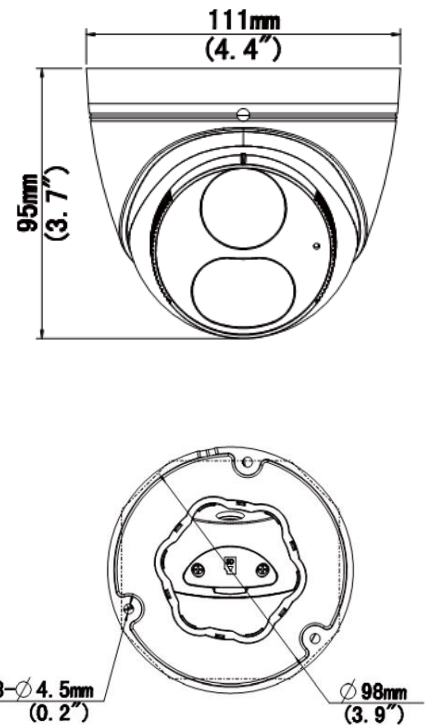

### Technical Specifications

| Device                 |   |
|------------------------|---|
| Image Sensor:          | 1/3", 4.0 Megapixel, Progressive Scan CMOS  |
| Min Illumination:      | Color: 0.003Lux (F1.6, AGC ON)   0Lux with IR   |
| Shutter Time:          | Auto/Manual, 1 ~ 1/100000s  |
| Lens:                  | 2.8mm @1.6  |
| WDR:                   | 120dB   |
| S/N                    | >52dB   |
| Angle of View:         | H:112.9°, V: 59.1°, O: 121.2°   |
| Angle Adjustment:      | Pan: 0° ~ 360°   Tilt: 0° ~ 80°   Rotate: 0° ~ 360°   |
| 3-Axis Adjustment:     | Yes   |
| Day & Night:           | IR-Cut Filter with Auto Switch (ICR)  |
| IR Range:              | Up to 30m (98ft) IR range   |
| Compression Standard   |   |
| Video Compression:     | H.265, H.264, MJPEG   |
| Video Bit Rate:        | 128 Kbps~16 Mbps  |
| Two-Stream:            | Yes   |
| Analytics:             | Crossline & Intrusion (based on Human Body Detection), Motion Detection, Tampering Alarm, Audio Detection |
| Image                  |   |
| Max. Image Resolution: | 2688 x 1520   |
| Frame Rate:            | 25fps (2688 x 1520)   |
| ROI Codec:             | Up to 8 areas   |
| Image Setting:         | White Balance, Digital Noise Reduction, Smart IR, Flip, HLC, BLC, Defog                                   |



## Technical Specifications

| Network                  |   |   |  |               |              |
|--------------------------|---|---|--|---------------|--------------|
| Protocols:               | IPv4, IPv6, IGMP, ICMP, ARP, TCP, UDP, DHCP, RTP, RTSP, RTCP, RTMP, DNS, DDNS, NTP, FTP, UPnP, HTTP, HTTPS, SMTP, SSL/TLS, 802.1x, SNMP |   |  |               |              |
| Interface                |   |   |  |               |              |
| Communication Interface: | 1 RJ45 10M/100M Base-TX Ethernet  |   |  |               |              |
| Edge Storage:            | Micro SD, up to 128GB   |   |  |               |              |
| Audio:                   | Built-in Mic & Speaker  |   |  |               |              |
| Audio Compression:       | G.711   |   |  |               |              |
| DORI                     |   |   |  |               |              |
| DORI Distance            | Lens (mm)   | Detect (m)  | Observe (m)  | Recognize (m) | Identify (m) |
|                          | 2.8   | 63.0  | 25.2   | 12.6          | 6.3          |
| General                  |   |   |  |               |              |
| Safety                   | CE: EN 62368-1<br>UL: UL 62368-1  |   |  |               |              |
| EMC                      | FCC: FCC Part 15<br>CE-EMC: EN 55032/ EN 55035/ EN IEC 61000-3-2/ EN 61000-3-3  |   |  |               |              |
| Operating Conditions:    | Temperature: -30°C ~ 60°C (-22°F ~ 140°F),<br>Humidity: ≤95% RH (Non-Condensing)  |   |  |               |              |
| Power Consumption:       | Max 8.0W  |   |  |               |              |
| Power Supply:            | DC 12V±25%, PoE (IEEE 802.3af)  |   |  |               |              |
| Weather Proof Rating:    | IP67  |   |  |               |              |
| Vandal Resistant:        | -   |   |  |               |              |
| Dimensions:              | Φ111 x 95mm (Ø4.4" x 3.7")  |   |  |               |              |
| Weight:                  | 0.54kg  |   |  |               |              |
| Software:                | No license required for use with Video Insight Software   |   |  |               |              |
| Optional Accessories     |   |   |  |               |              |
|                          | M-JB-T<br>   | M-WM-JB-MINI<br> | M-WM-MINI<br> |               |              |
|                          | M-Pendant-Ex<br>                                     | M-Pendant<br>    | M-PM<br>      |               |              |
|                          | M-NPT34<br>  |   |  |               |              |