

Overview

- 4 Megapixel IR
- True WDR 120dB
- 4.8mm to 120mm Lens
25x Optical Zoom
- H.265, H.264, MJPEG
- IR distance up to 100m / 328ft
- IP67, IK10
- NDAA Compliant
- ONVIF Profile G, S, T







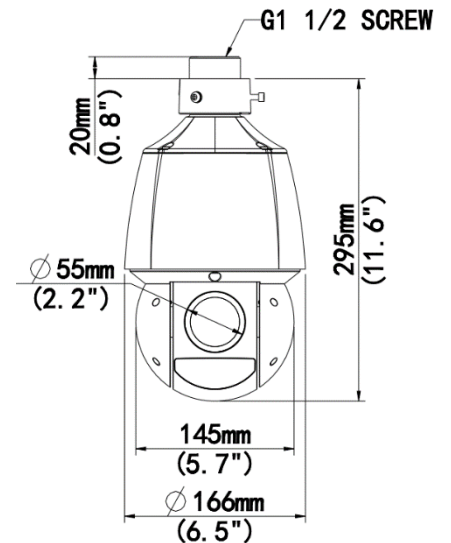

Technical Specifications

Device	
Image Sensor:	1 / 2.8", 4MP Progressive Scan CMOS
Min Illumination:	Color: 0.003Lux (F1.5, AGC ON) 0Lux with IR
Shutter Time:	Auto/Manual, 1 ~ 1/100000s
Lens:	4.8mm to 120mm AF automatic focusing and motorized zoom lens
WDR:	120 dB
S/N:	>56dB
Angle of View :	H: 52.20°~2.74°, V: 30.81°~1.54°, O: 64.20°~3.23°
Angle Adjustment:	360° (endless), -15° ~ 90° (auto reverse)
Digital Zoom	16x
Optical Zoom	25x
Day & Night:	IR-Cut Filter with Auto Switch (ICR)
IR Range:	Up to 100m (328ft) IR range
Compression Standard	
Video Compression:	H.265, H.264, MJPEG
Video Bit Rate:	128 Kbps~16 Mbps
Triple-Stream:	Yes
Analytics:	Motion detection, Audio detection, Tampering Alarm, Line crossing detection, Intrusion Detection, Enter Area, Leave Area Detection
Image	
Max. Image Resolution:	2688*1520
Frame Rate:	30fps (2688*1520)
ROI Codec:	Support
Image Setting:	White Balance, Digital Noise Reduction, Smart IR, HLC, BLC, Defog
Network	
Protocols:	IPv4, IGMP, ICMP, ARP, TCP, UDP, DHCP, PPPoE, RTP, RTSP, RTCP, DNS, DDNS, NTP, FTP, UPnP, HTTP, HTTPS, SMTP, 802.1x, SNMP, QoS, RTMP,SSL/TLS



Technical Specifications

Interface					
Communication Interface:	10M/100M Base-TX Ethernet				
Edge Storage:	Micro SD, up to 256 GB				
Audio Compression:	G.711U,G.711A				
Audio I/O:	1/1				
Alarm I/O:	2/1				
Serial Port:	1 x RS485				
DORI					
DORI Distance	Lens (mm)	Detect (m)	Observe (m)	Recognize (m)	Identify (m)
	4.8	119.3	47.7	23.9	11.9
	120	2475.0	990.0	495.0	247.5
General					
Safety:	CE: EN 62368-1, UL: UL 62368-1				
EMC	FCC: FCC Part 15 CE-EMC: EN 55032/ EN 55035/ EN IEC 61000-3-2/ EN 61000-3-3				
Operating Conditions:	Temperature: -40°C~70°C(-40°F~158°F), Humidity: ≤95%RH(Non-Condensing)				
Power Consumption:	Max 21.0 W				
Power Supply:	DC 12V±25% 3A, PoE+ (IEEE 802.3af)				
Weather Proof Rating:	IP67				
Vandal Resistant:	IK10				
Dimensions:	Ø166 x 295mm (Ø6.5" x 11.6")				
Net Weight:	3.05kg (6.72lb)				
Software:	No license required for use with Video Insight Software				
Optional Accessories					
	M-PTZ Pendant 	M-PTZ-JB 	M-PTZ-WM 		
	M-PTZ Pendant-EX-S 	M-PTZ-CNR 	M-CM 		
	M-PTZ-PM 	M-Parapet 