

Overview

- 2 Megapixel IR
- True WDR 120dB
- 4.5mm to 148.5mm lens / 33x Optical Zoom
- H.265, H.264, MJPEG
- IP66 Rated
- NDAA Compliant
- ONVIF Profile G, S, T







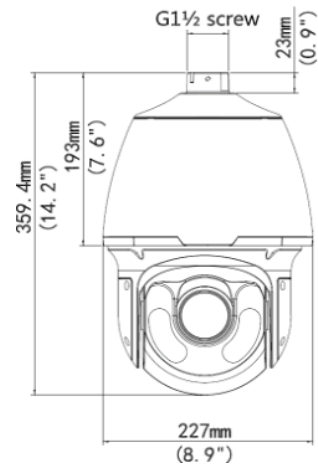



Technical Specifications

Device	
Image Sensor:	1/2.8", 2.0 Megapixel, Progressive Scan, CMOS
Min Illumination:	Color: 0.001 Lux (F1.5, AGC ON) 0 Lux with IR
Shutter Time:	Auto/Manual, 1 ~ 1/100000s
Lens:	4.5 ~ 148.5mm, AF Automatic Focusing And Motorized Zoom Lens
WDR:	120dB
S/N:	>52dB
Angle of View:	H: 56.2° ~ 2.6°, V: 33.5° ~ 1.4°, O: 65.4° ~ 3.0°
Angle Adjustment:	Pan: 360° (endless) Tilt:-15° ~ 90° (auto reverse)
3-Axis Adjustment:	—
Digital Zoom:	16x
Day & Night:	IR-cut filter with auto switch (ICR)
IR Range:	Up to 150m (492 ft) IR range
Compression Standard	
Video Compression:	H.265, H.264, MJPEG
Video Bit Rate:	128 Kbps~16 Mbps
Triple Stream:	Yes
Analytics:	Motion detection, Audio detection, Tampering Alarm, Line crossing detection, Intrusion Detection, Enter Area, Leave Area Detection
Image	
Max. Image Resolution:	1920 x 1080
Frame Rate:	60fps (1920 x 1080)
ROI Codec:	Support
OSD:	Up to 8 OSDs
Image Setting:	White Balance, Digital Noise Reduction, Flip, HLC, BLC, Defog



Technical Specifications

Network					
Protocols:	IPv4, IGMP, ICMP, ARP, TCP, UDP, DHCP, PPPoE, RTP, RTSP, RTCP, DNS, DDNS, NTP, FTP, UPnP, HTTP, HTTPS, SMTP, 802.1x, SNMP, QoS, RTMP, SSL/TLS				
Interface					
Communication Interface:	1 * RJ45 10M/100M Base-TX Ethernet				
Edge Storage:	Micro SD, up to 256GB				
Audio Compression:	G.711U, G.711A				
DORI					
DORI	Lens (mm)	Detect (m)	Observe (m)	Recognize (m)	Identify (m)
Distance	4.5	72.9	29.2	14.6	7.3
	148.5	2187.9	875.2	437.6	218.8
General					
Safety	CE (EN 62368-1:2014+A11:2017) CB (IEC 62368-1:2014) UL (UL 62368-1, 2nd Ed., Issue Date: 2014-12-01)				
EMC	CE-EMC (EN 55032:2015+A11:2020; EN IEC 61000-3-2:2019; EN 61000-3-3:2013+A1:2019; EN 55035:2017+A11:2020) FCC (FCC CFR 47 part15 B, ANSI C63.4-2014)				
Operating Conditions:	Temperature: -40°C ~65°C (-40°F ~ 149°F), Humidity: ≤95% RH				
Power Consumption:	Max 48W				
Power Supply:	AC 24V±25%, DC 24V±25%, PoE (PSE Required)				
Weather Proof Rating:	IP66				
Dimensions:	Ø227 x 359.4mm (Ø8.9" x 14.2")				
Weight:	5.3kg (11.68lb)				
Software:	No license required for use with Video Insight Software				
Optional Accessories					
	M-PTZ Pendant 	M-PTZ-JB 	M-PTZ Pendant-EX-L 		
	M-PTZ Pendant-EX-S 	M-PTZ-CNR 	M-CM 		
	M-PTZ-PM 	M-Parapet 	M-PTZ-WM 