

WV-U2530LA

2MP (1080p) Outdoor Dome Network Camera

New U-series compact network camera with enhanced functions and affordability

The new U series is an entry model that achieves high quality and reliability at an affordable price to meet the needs of a wide range of customers.



- 2MP (1080p) up to 30fps
- iA (intelligent Auto)
- Super Dynamic 120dB
- Color night vision (0.006 to 0.1 lx)
- H.265 Smart Coding
- Corridor mode (90 degrees or 270 degrees in image rotation)
- Built-in IR LED
- NDAA Compliant



SPECIFICATIONS

Camera	
Image Sensor	Approx. 1/3 type CMOS image sensor
Minimum Illumination	Color : 0.1 lx, BW: 0.04 lx (50IRE, F2.0, Maximum shutter: Off (1/30s), AGC: 11) BW : 0 lx (50IRE, F2.0, Maximum shutter: OFF (1/30 s), AGC: 11, when the IR LED is lit) Color : 0.006 lx, BW: 0.0025 lx (50IRE, F2.0, Maximum shutter: max. 16/30s, AGC: 11)
White Balance	ATW1/ ATW2/ AWC
Maximum Shutter	[30fps mode] Max. 1/10000 s to Max. 16/30 s [25fps mode] Max. 1/10000 s to Max. 16/25 s
Intelligent Auto	On / Off
Super Dynamic	On / Off, the level can be set in the range of 0 to 31.
Dynamic Range	Max.120 dB (Super Dynamic: On, Level: 31)
Adaptive Black Stretch	The level can be set in the range of 0 to 255.
Back Light Compensation/High Light Compensation	BLC (Back light compensation) / HLC (High light compensation) / Off The level can be set in the range of 0 to 31. (only when Super Dynamic/ Intelligent auto: Off)
Fog Compensation	On / Off, The level can be set in the range of 0 to 8. (only when Intelligent auto / auto contrast adjust: Off)
Maximum Gain (AGC)	The level can be set in the range of 0 to 11.
Color/BW (ICR)	Off/ On (IR Light Off) / On (IR Light On) / Auto1 (IR Light Off) / Auto2 (IR Light On) / Auto3 (SCC)
IR LED Light	High/ Middle/ Low/ Off Maximum irradiation distance: 30 m {Approx. 100 ft}
Digital Noise Reduction	The level can be set in the range of 0 to 255.
Video Motion Detection (VMD)	On / Off, 4 areas available
Scene Change Detection(SCD)	On / Off, 1 areas available
Privacy Zone	On / Off (up to 8 zones available)
VIQS	On / Off, Up to 8 zones available
Image Rotation	0° (Off) / 90° / 180° (Upside-down) / 270°
Camera Title (OSD)	On / Off, Up to 20 characters (alphanumeric characters, marks)
Lens	
Focal Length	3.2 mm{1/8 inches}
Optical Zoom	1x
Extra zoom	1.0x - 1.5x(when resolution is 1280x720)
Digital (electronic) zoom	Choose from 3 levels of x1, x2, x4
Angular Field of View	[16 : 9 mode] Horizontal : 97°, Vertical : 53° [4 : 3 mode] Horizontal : 71°, Vertical : 53°
Maximum Aperture Ratio	1 : 2.0
Focusing Range	1 m {39-3/8 inches} - ∞
DORI	
Detect (25ppm / 8ppf)	37.5 m / 122.9 ft

Observe (62.5ppm / 19ppf)	15.0 m / 49.2 ft
Recognize (125ppm / 38ppf)	7.5 m / 24.6 ft
Identify (250ppm / 76ppf)	3.7 m / 12.3 ft
Adjusting Angle	
Adjusting Angle	Horizontal (PAN) angle: -175 °- +175 °, Vertical (TILT) angle: -30 °- +80 ° Azimuth (YAW) angle: ±100°
Browser GUI	
Camera Control	Brightness
GUI / Setup Menu Language	English, Italian, French, German, Spanish, Portuguese, Russian, Chinese, Japanese
Network	
Network IF	10Base-T / 100Base-TX, RJ45 connector
Resolution H.265/H.264	[16 : 9 mode] 1920×1080, 1280×720, 640×360, 320×180 [4 : 3 mode] 1600×1200, 1280×960, VGA, QVGA
H.265/H.264	[Transmission Mode] Constant bit rate / VBR / Frame rate / Best effort [Transmission Type] Unicast port(AUTO) / Unicast port MANUAL) / Multicast [Max. frame rate foreach stream] Stream(1) : 1920x1080(30fps) / 1280x720(30fps) / 1600x1200(30fps) Stream(2) : 640x360(30fps) / 1280x720(30fps) / 640x480(30fps) Stream(3) : Off / Off / Off JPEG(1) : 1920x1080(1fps) / 1920x1080(1fps) / 1600x1200(1fps) JPEG(2) : 1280x720(1fps) / 1280x720(1fps) / 1280x960(1fps)
JPEG	[Image Quality] 10 steps
Smart Coding	GOP(Group of pictures) control: On(Frame rate control) / On(Advanced) / On(Mid.) / On(Low) / Off *Frame rate control and Advanced are only available with H.265. AUTO VIQS: On/ Off
Audio Compression	-
Audio Transmission Mode	-
Supported Protocol	IPv6 : TCP/IP, UDP/IP, HTTP, HTTPS, SSL/TLS, SMTP, DNS, NTP, SNMPv1/v2/v3, DHCPv6, RTP, MLD, ICMP, ARP, IEEE 802.1X, DiffServ, MQTT, LLDP IPv4 : TCP/IP, UDP/IP, HTTP, HTTPS, SSL/TLS, RTSP, RTP, RTP/RTCP, SMTP, DHCP, DNS, DDNS,NTP, SNMPv1/v2/v3, UPnP, IGMP, ICMP, ARP, IEEE 802.1X, DiffServ, MQTT, LLDP
No. of Simultaneous Users	Up to 14 users (Depends on network conditions)
Secure	Device Certificate GlobalSign® pre-installed, User authentication,Host authentication, HTTPS, 802.1X Support, Data encryption
SDXC/SDHC/SD Memory Card (Option)	H.265/H.264 recording: Manual REC / Alarm REC (Pre/Post) / Schedule REC Compatible SDXC/SDHC/SD Memory Card : microSDXC memory card: 64 GB, 128 GB, 256 GB, 512 GB microSDHC memory card: 4 GB, 8 GB, 16 GB, 32 GB microSD memory card: 2 GB
Mobile Terminal Compatibility	iPad, iPhone, Android™ terminals
ONVIF® Profile	G / S / T
Alarm	
Alarm Source	VMD alarm, SCD alarm, Command alarm
Alarm Actions	SDXC/SDHC/SD memory recording, E-mail notification, HTTP alarm notification, Indication on browser, TCP alarm notification output

Input/Output	
Monitor Output (for Adjustment)	-
Audio input	-
Audio Output	-
External I/O Terminals	-
General	
Safety	UL (UL60950-1), c-UL (CSA C22.2 No.60950-1), CE, IEC60950-1
EMC	FCC (Part15 ClassA), ICES003 ClassA, EN55032 ClassB, EN55035
Power Source and Power Consumption	PoE (IEEE802.3af compliant) Device: DC48 V 100 mA, Approx. 4.8 W (Class 2 device)
Ambient Operating Temperature	-30 °C to +50 °C (-22 °F to +122 °F) {Power On range: -20 °C to +50 °C (-4°F to +122 °F)}
Ambient Operating Humidity	10 to 100 % (no condensation)
Anti-Condensation System	Temish element
Water and Dust Resistance	IP66 (IEC 60529), Type 4X (UL50E), NEMA 4X compliant
Shock Resistance	IK10 (IEC 62262)
Wind Resistance	Up to 40 m/s {approx. 89 mph}
Dimensions	ø109 mm (W) x 62 mm (H) {ø4-9/32 inches x 2-7/16 inches (H)} Dome radius 30.5 mm {1-3/16 inches}
Mass (Approx.)	270 g {0.60 lbs.}
Finish	Main body : Aluminum die cast / Polycarbonate resin, i-PRO white Outer fixing screws : Stainless steel (Corrosion-resistant treatment) Dome cover : Polycarbonate resin, Clear

NOTES

Important

- Safety Precautions : Carefully read the Basic Information, Installation Guide and Operating Instructions before using this product.
- i-PRO Co., Ltd. cannot be held responsible for the performance of the network and/or other manufacturers' products used on the network.
- Masses and dimensions are approximate.
- Specifications are subject to change without notice.

Trademarks and registered trademarks

- iPad and iPhone are trademarks of Apple Inc., registered in the U.S. and other countries. - Android is a trademark of Google LLC.
- ONVIF is a trademark of ONVIF, Inc.
- All other trademarks identified herein are the property of their respective owners

©i-PRO Co., Ltd All rights reserved / November 2022

OPTIONAL ACCESSORIES

Select a compatible accessory

[Accessory Selector \(i-pro.com\)](http://i-pro.com).



WV-QWL500-W
Mount Bracket



WV-QPL500-W
Mount Bracket



WV-QJB502-W
Mount Bracket



WV-QJB500-W
Mount Bracket



WV-QCN500-W
Mount Bracket



WV-QCL101-W
Mount Bracket



WV-QCL100-W
Mount Bracket



WV-QAT502-W
Gangbox Adapter



WV-QDC500S
Dome Cover

APPEARANCE

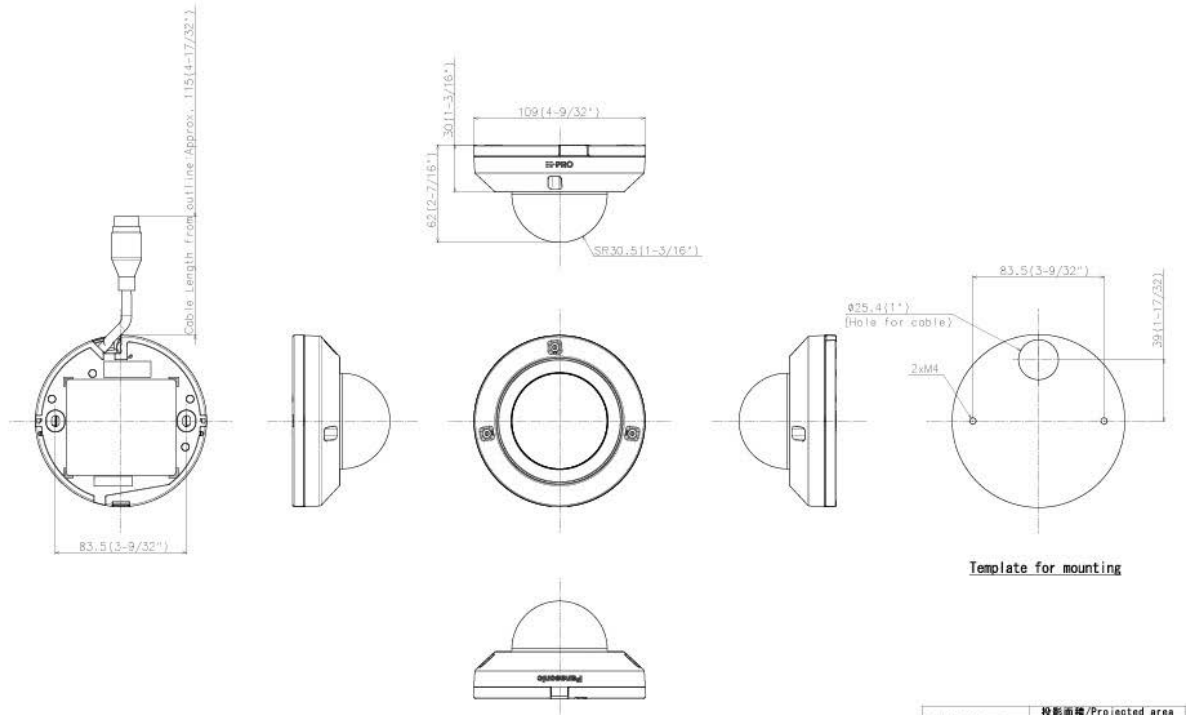

側面図/Side-view	投影面積/Projected area
	0.005 m ²

Mass : Approx. 370 g (10.60 lbs)

WV-U2530LA



Detail A (2:1)



Detail C (2:1)

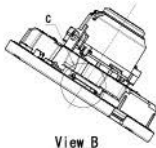

View B

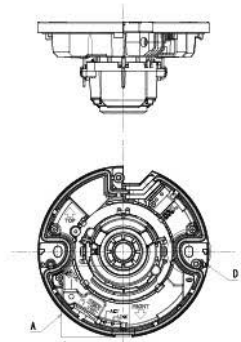

A

B

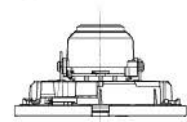

Without Enclosure

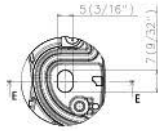

Detail D (2:1)
Symmetrical

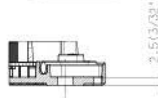

SEC F-E (2:1)
Symmetrical

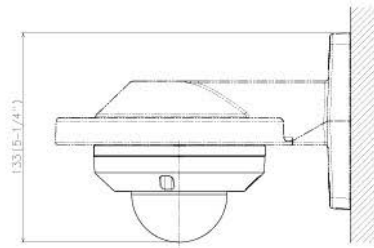

Attach to WV-QWL500-W

側面図/Side-view	投影面積/Projected area 0.013 (m ²)
---------------	--

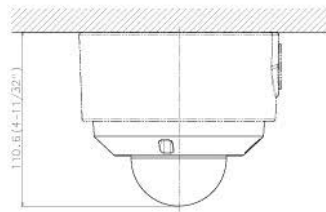

Attach to WV-QJB502-W

側面図/Side-view	投影面積/Projected area 0.011 (m ²)
---------------	--

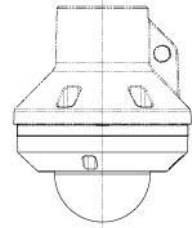

Attach to WV-QCL100-W

WV-U253CLA