

WV-S2536LN

2MP (1080p) Vandal Resistant Outdoor Dome Network Camera

i-PRO Extreme H.265 Dome Network camera

The WV-S2536LN comes with pre-installed AI analytics applications that detects people and vehicles with accuracy, allowing you to easily start state-of-the-art video surveillance.



- 2MP (1080p)
- Intelligent Auto (with AI Engine)
- Super Dynamic 144dB
- Color night vision (0.007 to 0.009 lx)
- Smart Coding (with AI Engine)
- ClearSight Coating
- Built-in IR LED
- Fiber Optic Media Converter Unit (Optional WV-S25F1)
- NDAA Compliant



SPECIFICATIONS

Camera	
Image Sensor	Approx. 1/2.8 type CMOS image sensor
Minimum Illumination	Color : 0.007 lx (30IRE, F1.3, 1/30s) , Color : 0.009 lx (50IRE, F1.3, 1/30s) BW : 0.005 lx (50IRE, F1.3, 1/30s) , BW : 0 lx (50IRE, F1.3,1/30s with IR LED)
White Balance	ATW1 / ATW2 / AWC
Shutter Speed	[60 fps Mode] 1/60 Fix to 1/10000 Fix, [30 fps/15 fps mode] 1/30 Fix to 1/10000 Fix [50 fps Mode] 1/50 Fix to 1/10000 Fix, [25 fps/12.5 fps mode] 1/25 Fix to 1/10000 Fix
Intelligent Auto	On / Off
Super Dynamic*2	On / Off, The level can be set in the range of 0 to 31.
Dynamic Range	Max.144 dB (Super Dynamic : On, Level 31)
Adaptive Black Stretch	The level can be set in the range of 0 to 255.
Back light compensation / High light compensation	BLC (Back light compensation) / HLC (High light compensation) / Off (only when Super dynamic / Intelligent Auto : Off)
Fog Compensation	On / Off (only when Intelligent auto / auto contrast adjust : Off)
Maximum Gain (AGC)	The level can be set in the range of 0 to 11.
Color/BW (ICR)	Off / On (IR Light Off) / On (IR Light On) / Auto1 (IR Light Off) / Auto2 (IR Light On) / Auto3 (SCC)
IR LED Light	High / Middle / Low / Off, Maximum irradiation distance : 70 m {Approx. 230 ft} (30IRE), 50 m {Approx. 164 ft} (50IRE)
Digital Noise Reduction	The level can be set in the range of 0 to 255.
Video Motion Detection (VMD)	On / Off, 4 areas available
Scene Change Detection (SCD)	On / Off, 1 areas available
Audio Detection	On / Off
AI Sound classification	Gunshot, Yell, Vehicle horn, Glass break
AI Analytics	Yes
Privacy Zone	On / Off, Up to 8 zones available
VIQS	On / Off, Up to 8 zones available
Image rotation*3	0 ° / 90 ° / 180 ° / 270 °
Camera Title (OSD)	On / Off, Up to 40 characters (alphanumeric characters, marks)
Focus Adjustment	Auto focus
Lens	
Optical Zoom	3.1x (Motorized zoom / Motorized Focus)
Extra zoom	3.1x - 9.3x (when resolution is 640 x 360)
Focal Length	2.9 - 9 mm {1/8 inches - 11/32 inches}
Angular Field of View	[16 : 9 mode] Horizontal : 36° (TELE) – 113° (WIDE), Vertical : 20° (TELE) – 60° (WIDE) [4 : 3 mode] Horizontal : 26° (TELE) – 82° (WIDE), Vertical : 20° (TELE) – 60° (WIDE)

Maximum Aperture Ratio	1 : 1.3 (WIDE) – 1 : 2.5 (TELE)
Focusing Range	0.3 m {11-13/16 inches} – ∞
DORI	
Detect (25ppm / 8ppf)	Wide: 25.4m / 83.4 ft, Tele: 118.2 m / 387.7 ft
Observe (62.5ppm / 19ppf)	Wide: 10.2 m / 33.4 ft, Tele: 47.3 m / 155.1 ft
Recognize (125ppm / 38ppf)	Wide: 5.1 m / 16.7 ft, Tele: 23.6 m / 77.5 ft
Identify (250ppm / 76ppf)	Wide: 2.5m / 8.3 ft, Tele: 11.8 m / 38.8 ft
Adjusting Angle	
Adjusting Angle	Horizontal : -194 to +166°, Vertical : -30 to +85°, Yaw : ±100°
Browser GUI	
Camera Control	Brightness, AUX On / Off
Audio	Mic (Line) Input : On / Off Volume adjustment : Low / Middle / High Audio Output : On / Off Volume adjustment : Low / Middle / High
GUI / Setup Menu Language	English, Italian, French, German, Spanish, Portuguese, Russian, Chinese, Japanese
Browser*4	Microsoft Edge, Firefox, Google Chrome
Network	
Network IF	10Base-T / 100Base-TX, RJ45 connector
Resolution H.265/ H.264/ JPEG (MJPEG)	[16 : 9 mode (60 fps mode)], [16 : 9 mode (30 fps mode)], [16 : 9 mode (50 fps mode)], [16 : 9 mode (25 fps mode)] 1920x1080, 1280x720, 640x360, 320x180 [4 : 3 mode (30 fps mode)], [4 : 3 mode (25 fps mode)] 1280x960, VGA, QVGA [4 : 3 mode (15 fps mode)], [4 : 3 mode (12.5 fps mode)] 2048x1536, 1280x960, VGA, QVGA
JPEG - Image Quality	10 steps
Smart Coding	GOP (Group of pictures control): Off/ Low (Variable GOP 1s-8s) / Mid (Variable GOP 4s-16s) / Advanced(Fixed GOP 60s w/1s key-frame) / Frame rate control (Variable GOP 4s-16s with frame rate control) *Advanced and Frame rate control are only available with H.265. Smart VIQS: On(High)/On(Low)/Off, Smart P-picture control: On/Off
Audio Compression	G.726 (ADPCM) : 16 kbps / 32 kbps , G.711 : 64 kbps AAC-LC : 64 kbps / 96 kbps / 128 kbps
Audio Transmission Mode	Off / Mic (Line) input / Audio output / Interactive (Half duplex) / Interactive (Full duplex)
Supported Protocol	IPv6 : TCP/IP, UDP/IP, HTTP, HTTPS, SSL/TLS, SMTP, DNS, NTP, SNMPv1/v2/v3, DHCPv6, RTP, MLD, ICMP, ARP, IEEE,802.1X,DiffServ, LLDP IPv4 : TCP/IP, UDP/IP, HTTP, HTTPS, SSL/TLS, RTSP, RTP, RTP/RTCP, SMTP, DHCP, DNS, DDNS, NTP, SNMPv1/v2/v3, UPnP, IGMP, ICMP, ARP, IEEE 802.1X, DiffServ, SRTP, LLDP
No. of Simultaneous Users	Up to 14 users (Depends on network conditions)
Secure	Device Certificate GlobalSign® pre-installed, User authentication,Host authentication, HTTPS, 802.1X Support, Data encryption

SDXC/SDHC/SD Memory Card (Option)	H.265 / H.264 recording : Manual REC / Alarm REC (Pre/Post) / Schedule REC / Backup upon network failure JPEG recording : Manual REC / Alarm REC (Pre/Post) / Backup upon network failure Available SDXC/SDHC/SD Memory Card : microSDXC memory card : 64 GB, 128 GB, 256 GB, 512 GB microSDHC memory card : 4 GB, 8 GB, 16 GB, 32 GB microSD memory card : 2 GB
Mobile Terminal Compatibility	iPad, iPhone, Android™ terminals
ONVIF Profile	G / S / T / M

Alarm	
Alarm Source	3 terminals input, VMD alarm, Command alarm, Audio detection alarm
Alarm Actions	SDXC/SDHC/SD memory recording, E-mail notification, HTTP alarm notification Indication on browser, TCP alarm notification output

Input/Output	
Monitor Output (for Adjustment)	VBS : 1.0 V [p-p] / 75 Ω, composite, Pin jack An NTSC or PAL signal can be outputted from camera
Audio input*8	ø3.5 mm stereo mini jack
Audio Output*8	ø3.5 mm stereo mini jack (monaural output) Output impedance : Approx. 600 Ω (unbalanced) , Output level : -20 dBV
External I/O Terminals*8	ALARM IN 1 (Alarm input 1/ Black & white input/ Auto time adjustment input) (x1) ALARM IN 2 (Alarm input 2/ ALARM OUT) (x1), ALARM IN 3 (Alarm input 3/ AUX OUT) (x1)

General	
Safety	UL (UL62368-1), c-UL (CSA C22.2 No.62368-1), CE, IEC62368-1
EMC	FCC (Part15 ClassA), ICES-003 ClassA, EN55032 ClassB, EN55035
Power Source and Power Consumption	DC power supply*8 : DC12 V 730 mA, Approx. 8.8 W PoE (IEEE802.3af compliant) Device : DC48 V 190 mA, Approx. 9.1 W (Class 0 device)
Ambient Operating Temperature	-40 °C to +60 °C (-40 °F to 140 °F) (Power On range : -30 °C to +60 °C {-22 °F to +140 °F})
Ambient Operating Humidity	10 to 100 % (no condensation)
Anti-Condensation System	Temish element + Heater + moisture absorption gel
Water and Dust Resistance	IP66, IEC60529 measuring standard compatible, Type 4X(UL50E), NEMA 4X compliant
Shock Resistance	50J (IEC 60068-2-75 compliant), IK10 (IEC 62262)
Dimensions	ø154 mm x 105 mm (H) {ø6-1/16 inches x 4-1/8 inches (H)}
Mass (Approx.)	Approx. 1.1 kg {2.43 lbs.}
Finish	Main body : Aluminum die cast and resin, i-PRO white Outer fixing screws : Stainless steel (Corrosion-resistant treatment) Dome section : Polycarbonate resin, Clear (with ClearSight coating)

NOTES

Important

- Safety Precautions : Carefully read the Basic Information, Installation Guide and Operating Instructions before using this product.
- i-PRO Co., Ltd. cannot be held responsible for the performance of the network and/or other manufacturers' products used on the network.
- Masses and dimensions are approximate. Specifications are subject to change without notice.

Trademarks and registered trademarks

- iPad and iPhone are trademarks of Apple Inc., registered in the U.S. and other countries. - Android is a trademark of Google LLC.
- ONVIF is a trademark of ONVIF, Inc.

- All other trademarks identified herein are the property of their respective owners
©i-PRO Co., Ltd All rights reserved / November 2022

OPTIONAL ACCESSORIES

Select a compatible accessory

[Accessory Selector \(i-pro.com\)](http://i-pro.com)



WV-QWL501-W
Mount Bracket



WV-QWL500-W
Mount Bracket



WV-QSR501-W
Mount Bracket



WV-QSR500-W
Sun Shade



WV-QPL500-W
Mount Bracket



WV-QJB504-W
Base Bracket



WV-QJB501-W
Base Bracket



WV-QJB500-W
Mount Bracket



WV-QEM500-W
Mount Bracket



WV-QCN500-W
Mount Bracket



WV-QCL501-W
Mount Bracket



WV-QCL101-W
Mount Bracket



WV-QCL100-W
Mount Bracket



WV-QAT501-W
Attachment Pipe
Bracket



WV-QAT500-W
Attachment pipe



WV-Q105A
Mount Bracket



PWM485W
Wall Mount and Shroud



PS485AW
Shroud



PPRM35AW
Parapet Mount Bracket



PAPM4W
Pole Mount Bracket



PACA4W
Corner Mount Adapter
Bracket



WV-QCA501A
I/O Cable



WV-QCA500A
RJ45 Ethernet Cable



WV-CW7SN
Dome cover



WV-CW7S
Dome cover



WV-CW7CN
Dome cover



WV-PM500
Compact microphone
unit for surveillance
cameras

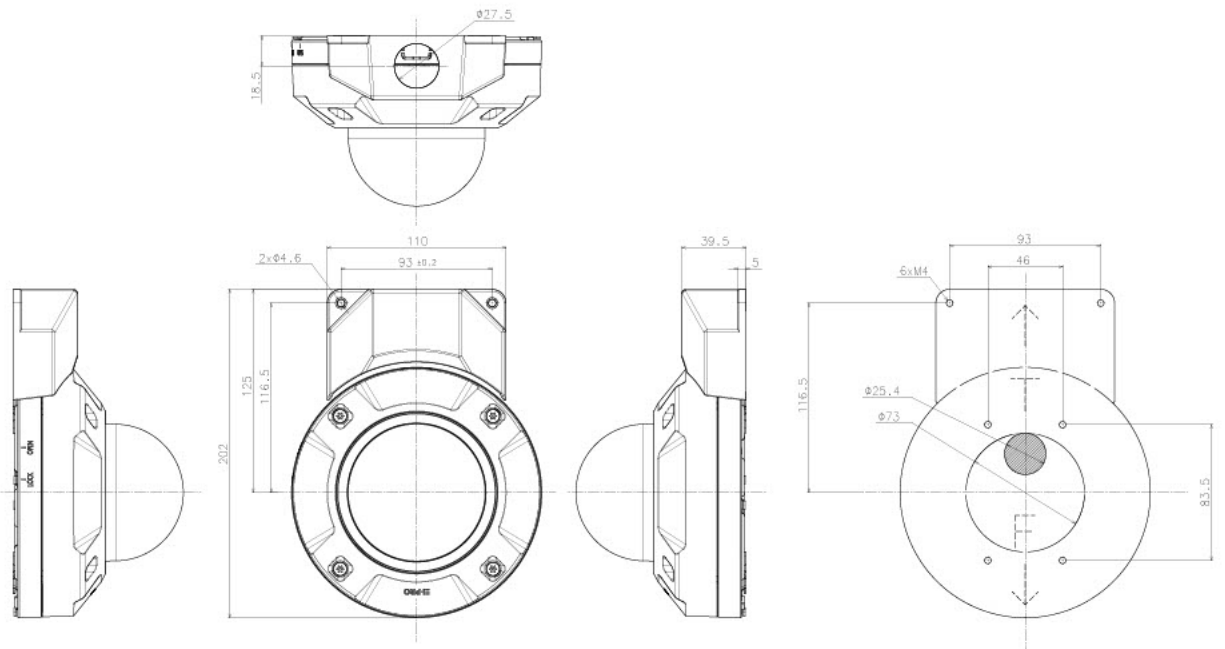

With Attachment for the conduit

Template for mounting

投影面積/Projected area
側面圖/Side-view 0.013(m ²)

WV-S2536LN

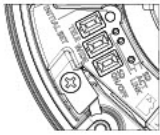
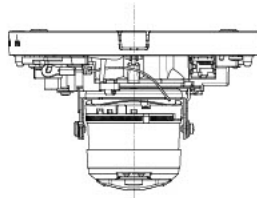

Detail B (2:1)

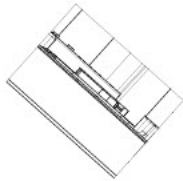
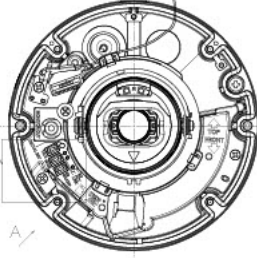
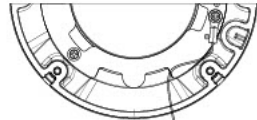

View A (2:1)

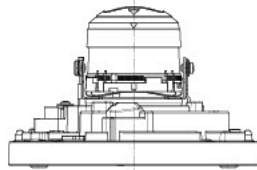

Without Enclosure

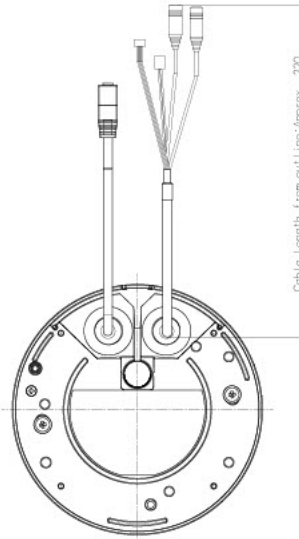

Cable Length from out Line: Approx. 220

WV-S2536LN