

WV-S15700-V2L

4K Outdoor Bullet Network Camera

S-series High resolution Network camera with AI engine



- 4K
- Intelligent Auto (with AI Engine)
- Super Dynamic 132dB
- Color night vision (0.04 to 0.06 lx)
- Smart Coding (with AI Engine)
- Built-in IR LED
- IK10 Vandal Resistant
- Built-in FIPS 140-2 Level 3 Certified Secure Element
(EdgeLock® SE050F NXP® Semiconductors)
- NDAA Compliant

SPECIFICATIONS

Camera	
Image Sensor	1/1.8 type CMOS image sensor
Scanning Area	7.68 mm (H)×4.32 mm (V) {5/16 inches (H) × 5/32 inches (V)}
Minimum Illumination	Color : 0.04 lx (30IRE, F1.5, 1/30s) Color : 0.06 lx (50IRE, F1.5, 1/30s) BW : 0.03 lx (50IRE, F1.5, 1/30s) BW : 0 lx (50IRE, F1.5,1/30s with IR LED)
White Balance	ATW1/ ATW2/ AWC
Shutter Speed	[30 fps/15 fps mode] 1/30 Fix to 1/10000 Fix [25 fps/12.5 fps mode] 1/25 Fix to 1/10000 Fix
Intelligent Auto	On / Off
Super Dynamic	On / Off, The level can be set in the range of 0 to 31.
Dynamic Range	Max. 132 dB (Super Dynamic : On, Level : 30 or more, 15fps)
Adaptive Black Stretch	The level can be set in the range of 0 to 255.
Back Light Compensation/High Light Compensation	BLC (Back light compensation) / HLC (High light compensation) / Off (only when Super dynamic / Intelligent Auto : Off)
Fog Compensation	On / Off (only when Intelligent auto / auto contrast adjust : Off)
Maximum Gain	The level can be set in the range of 0 to 11.
Color/BW (ICR)	Off / On (IR Light Off) / On (IR Light On) / Auto1 (IR Light Off) / Auto2 (IR Light On) / Auto3 (SCC)
IR LED Light	High / Middle / Low / Off, Maximum irradiation distance : 70 m {Approx. 230 ft} (30IRE) 50 m {Approx. 164 ft} (50IRE)
Digital Noise Reduction	The level can be set in the range of 0 to 255.
Video Motion Detection (VMD)	On / Off, 4 areas available
Scene Change Detection (SCD)	On / Off, 1 areas available
Audio Detection	On / Off
AI Sound Classification	Gunshot, Yell, Vehicle horn, Glass break
AI Analytics	AI Video Motion Detection, AI Privacy Guard, AI Face Detection, AI People Detection, AI Vehicle Detection, AI Non mask Detection, AI Occupancy Detection, AI Scene Change Detection For details : https://i-pro.com/products_and_solutions/en/surveillance/products/analytics-software 3rd party applications are also available. https://i-pro.com/products_and_solutions/en/surveillance/solutions/edge-ai-platform/application-list
Privacy Zone	On / Off, Up to 8 zones available
VIQS	On / Off, Up to 8 zones available
Image Rotation	0 ° / 90 ° / 180 ° / 270 °

Camera Title (OSD)	On / Off, Up to 40 characters (alphanumeric characters, marks)
Focus Adjustment	Auto focus
Lens	
Optical zoom	2.0x (Motorized zoom / Motorized focus)
Extra zoom	2.0x - 6.0x (when resolution is 1280 x 720)
Focal length	4.3 - 8.6 mm {5/32 inches - 11/32 inches}
Angular Field of View	[16 : 9 mode]*[4:3 mode] is not supported. Horizontal : 53° (TELE) - 104° (WIDE), Vertical : 30° (TELE) - 56° (WIDE)
Maximum Aperture Ratio	1 : 1.5 (WIDE) - 1 : 2.4 (TELE)
Focus range	1.0 m {39-3/8 inches} - ∞
DORI	
Detect (25ppm / 8ppf)	Wide: 60.0 m / 196.9 ft, Tele: 154.0 m / 505.4 ft
Observe (62.5ppm / 19ppf)	Wide: 24.0 m / 78.7 ft, Tele: 61.6 m / 202.1 ft
Recognize (125ppm / 38ppf)	Wide: 12.0 m / 39.4 ft, Tele: 30.8 m / 101.1 ft
Identify (250ppm / 76ppf)	Wide: 6.0 m / 19.7 ft, Tele: 15.4 m / 50.5 ft
System on Chip (SoC)	
System on Chip (SoC)	Ambarella CV22
Adjusting Angle	
Ceiling mounting	Horizontal : ±180 ° (PAN rotation part) Vertical : 0 ° to 100 ° (TILT rotation part) Yaw : -190 ° to +100 ° (YAW rotation part)
Wall mounting	Horizontal : ±100 ° (TILT rotation part)* Vertical : ±100 ° (TILT rotation part)* Yaw : -190 ° to +100 ° (YAW rotation part) * You can change between horizontal and vertical angels by adjusting the PAN rotation part.
Browser GUI	
Camera Control	Brightness, AUX On / Off
Audio	Mic (Line) Input : On / Off Volume adjustment : Low / Middle / High Audio Output : On / Off Volume adjustment : Low / Middle / High
GUI / Setup Menu Language	English, Italian, French, German, Spanish, Portuguese, Russian, Chinese, Japanese
Browser	Microsoft Edge, Firefox, Google Chrome
Network	
Network IF	10Base-T / 100Base-TX, RJ45 connector
Resolution H.265/ H.264/ JPEG (MJPEG)	[16 : 9 mode (30 fps mode)][16 : 9 mode (25 fps mode)] 3840x2160/ 2560x1440/ 1920x1080/ 1280x720/ 640x360/ 320x180
H.265/H.264	[Transmission Mode] Constant bit rate / VBR / Frame rate / Best effort [Transmission Type] Unicast port (AUTO) / Unicast port (MANUAL) / Multicast
JPEG	[Image Quality] 10 steps

Smart Coding	GOP (Group of pictures) control: Off/ Low (Variable GOP 1s-8s)/ Mid (Variable GOP 4s-16s)/ Advanced(Fixed GOP 60s w/1s key-frame)/ Frame rate control (Variable GOP 4s-16s with frame rate control) *Advanced and Frame rate control are only available with H.265. Smart VIQS: On(High)/On(Low)/Off, Smart P-picture control: On/Off
Audio Compression	G.726 (ADPCM) : 16 kbps / 32 kbps G.711 : 64 kbps AAC-LC : 64 kbps / 96 kbps / 128 kbps
Audio Transmission Mode	Off / Mic (Line) input / Audio output / Interactive (Half duplex) / Interactive (Full duplex)
Supported Protocol	IPv6 : TCP/IP, UDP/IP, HTTP, HTTPS, SSL/TLS, SMTP, DNS, NTP, SNMPv1/v2/v3, DHCPv6, RTP, MLD, ICMP, ARP, IEEE 802.1X, DiffServ, SFTP, MQTT, LLDP IPv4 : TCP/IP, UDP/IP, HTTP, HTTPS, SSL/TLS, RTSP, RTP, RTP/RTCP, SMTP, DHCP, DNS, DDNS, NTP, SNMPv1/v2/v3, UPnP, IGMP, ICMP, ARP, IEEE 802.1X, DiffServ, SRTP, SFTP, MQTT, LLDP
No. of Simultaneous Users	Up to 14 users (Depends on network conditions)
Secure	FIPS 140-2 level 3 Certified Secure Element (NXP® EdgeLock® SE050F), Device Certificate GlobalSign® pre-installed, User authentication, Host authentication, HTTPS, 802.1X Support, Data encryption
SDXC/SDHC/SD Memory Card	H.265 / H.264 recording : Manual REC / Alarm REC (Pre/Post) / Schedule REC / Backup upon network failure JPEG recording : Manual REC / Alarm REC (Pre/Post) / Backup upon network failure Compatible SDXC/SDHC/SD Memory Card : microSDXC memory card : 64 GB, 128 GB, 256 GB, 512 GB microSDHC memory card : 4 GB, 8 GB, 16 GB, 32 GB microSD memory card : 2 GB
Mobile Terminal Compatibility	iPad, iPhone(iOS 8.0 or later), Android™ terminals
ONVIF® Profile	G / M / S / T

Alarm

Alarm Source	3 terminals input, VMD alarm, Command alarm, Audio detection alarm
Alarm Actions	SDXC/SDHC/SD memory recording, E-mail notification, HTTP alarm notification Indication on browser, TCP alarm notification output

Input/Output

Monitor Output (for Adjustment)	VBS : 1.0 V [p-p] / 75 Ω, composite, Pin jack An NTSC or PAL signal can be outputted from camera
Audio input	ø3.5 mm stereo mini jack For microphone input : Recommended applicable microphone : Plug-in power type (Sensitivity of microphone : -51 dB to -38 dB (0 dB=1 V/Pa, 1 kHz)) Input impedance : Approx. 2 kΩ (unbalanced) Supply voltage : 2.5 V ±0.5 V For line input : Input level: Approx. -10 dBV
Audio Output	ø3.5 mm stereo mini jack (monaural output) Output impedance : Approx. 600 Ω (unbalanced) Output level : -20 dBV
External I/O Terminals	ALARM IN 1 (Alarm input 1/ Black & white input/ Auto time adjustment input) (x1) ALARM IN 2 (Alarm input 2/ ALARM OUT) (x1) ALARM IN 3 (Alarm input 3/ AUX OUT) (x1)

General

Safety	UL (UL62368-1), c-UL (CSA C22.2 No.62368-1), CE, IEC62368-1
--------	---

EMC	FCC (Part15 ClassA), ICES-003 ClassA, EN55032 ClassA, EN55035
Power Source and Power Consumption	DC power supply : DC12 V 1.0 A, Approx. 12.0 W PoE (IEEE802.3af compliant) Device : DC48 V 240 mA, Approx. 11.5 W (Class 0 device)
Ambient Operating Temperature	-40 °C to +60 °C (-40 °F to 140 °F) (Power On range : -30 °C to +60 °C {-22 °F to +140 °F})
Ambient Operating Humidity	10 to 100 % (no condensation)
Anti-Condensation System	Temish element + Heater + moisture absorption gel
Water and Dust Resistance	IP66, IEC60529 measuring standard compatible, Type 4X(UL50E), NEMA 4X compliant
Shock Resistance	IK10 (IEC 62262)
Dimensions	ø133 mm (W) x 133 mm (H) x 383 mm (D) {ø5-1/4 inches (W) x 5-1/4 inches (H) x 15-3/32 inches (D)}
Mass (approx.)	Approx. 2.4 kg {5.3 lbs.}
Finish	Main body : Aluminum die cast and resin, i-PRO white Outer fixing screws : Stainless steel (Corrosion-resistant treatment) Front panel : Polycarbonate resin, Clear

NOTES

Important

- Safety Precautions : Carefully read the Basic Information, Installation Guide and Operating Instructions before using this product.
- i-PRO Co., Ltd. cannot be held responsible for the performance of the network and/or other manufacturers' products used on the network.
- Masses and dimensions are approximate.
- Specifications are subject to change without notice.

Trademarks and registered trademarks

- iPad and iPhone are trademarks of Apple Inc., registered in the U.S. and other countries. - Android is a trademark of Google LLC.
- ONVIF is a trademark of ONVIF, Inc.
- All other trademarks identified herein are the property of their respective owners

©i-PRO Co., Ltd All rights reserved / November 2022

OPTIONAL ACCESSORIES

Select a compatible accessory

[Accessory Selector \(i-pro.com\)](http://i-pro.com).



WV-QPL500-W
Mount Bracket



WV-QCN500-W
Mount Bracket



WV-QCA501A
I/O Cable



WV-QCA500A
RJ45 Ethernet Cable



WV-PM500
Compact microphone
unit for surveillance
cameras

APPEARANCE

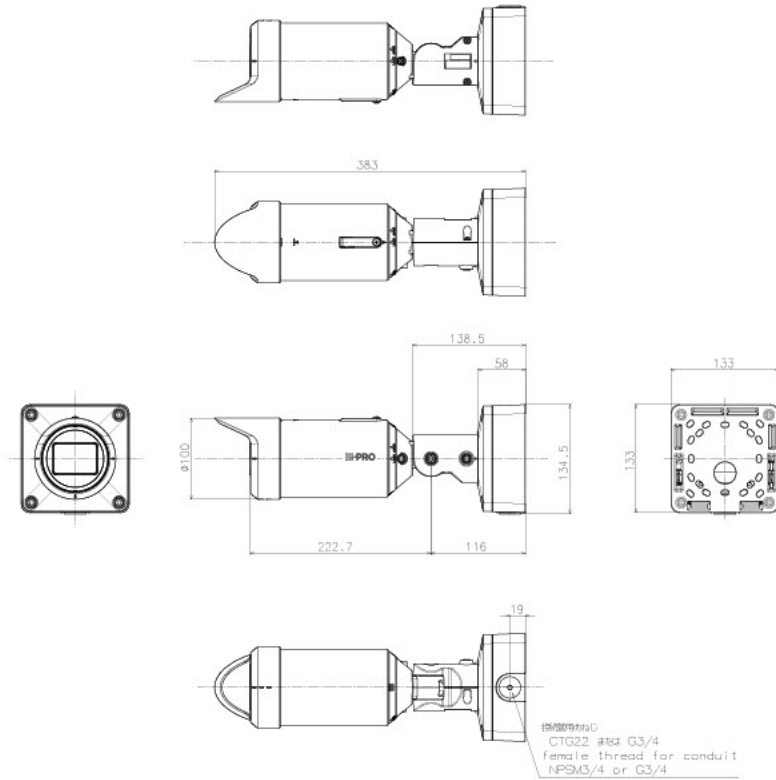

Model number	ClearSight coating	Color
WV-S15500-V3LN	Yes	i-PRO white
WV-S15500-V3L	No	i-PRO white
WV-S15500-V3LNJ	Yes	i-PRO white
WV-S15500-V3LNI	Yes	Black
WV-S15500-V3LK	Yes	i-PRO white (heavy salt damage resistance)
WV-S15600-V2L	No	i-PRO white
WV-S15600-V2LN	Yes	i-PRO white
WV-S15700-V2LN	Yes	i-PRO white
WV-S15700-V2L	No	i-PRO white
WV-S15700-V2LNJ	Yes	i-PRO white
WV-S15700-V2LK	Yes	i-PRO white (heavy salt damage resistance)
WV-S15700-V2LKI	Yes	i-PRO white (heavy salt damage resistance)

	投影面積/Projected area
平面圖/Top-view	0.033 (m ²)
側面圖/Side-view	0.030 (m ²)

Mass : Approx. 2.4 kg [5.3 lbs]

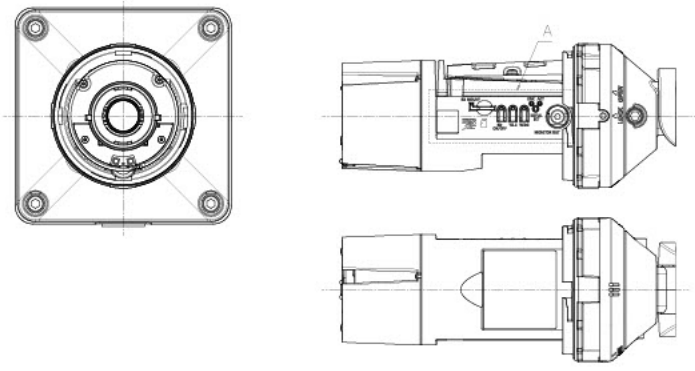
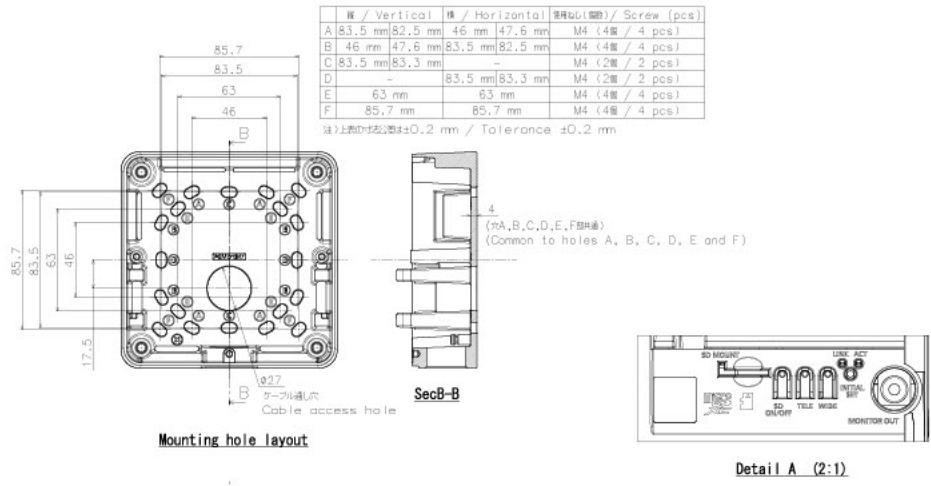

Model number	Lens type
WV-S15500-V3LN	5M
WV-S15500-V3L	
WV-S15500-V3LNJ	
WV-S15500-V3LN1	6M
WV-S15500-V3LK	
WV-S15600-V2L	
WV-S15600-V2LN	4K
WV-S15700-V2LN	
WV-S15700-V2L	
WV-S15700-V2LNJ	4K
WV-S15700-V2LK	
WV-S15700-V2LKJ	

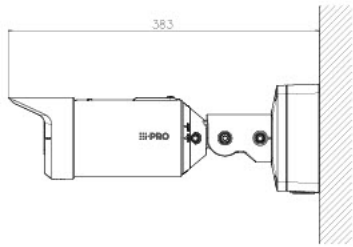

工事後の取付状態
Mounted state after construction

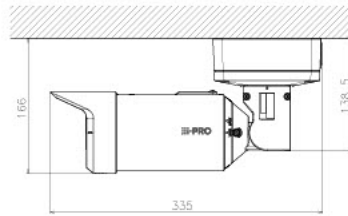
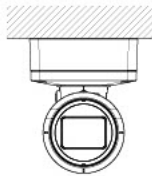

工事後の取付状態
Mounted state after construction

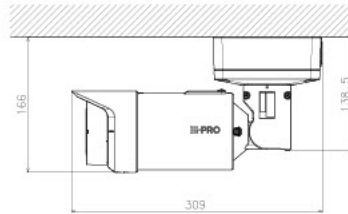
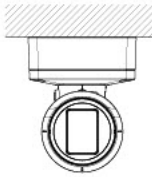
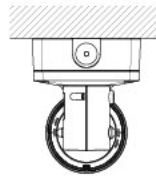

サンシェードを回転させた場合の設置状態
Installation condition for rotating the sunshade

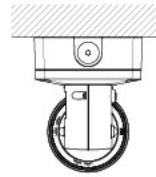

Model number
WV-S15500-V3LN
WV-S15500-V3L
WV-S15500-V3LNJ
WV-S15500-V3LN1
WV-S15500-V3LK
WV-S15600-V2L
WV-S15600-V2LN
WV-S15700-V2LN
WV-S15700-V2L
WV-S15700-V2LNJ
WV-S15700-V2LK
WV-S15700-V2LNJ