

Model number
 WV-U2132LA
 WV-U2132LAV

Mass : Approx. 350 g {0.77 lbs}

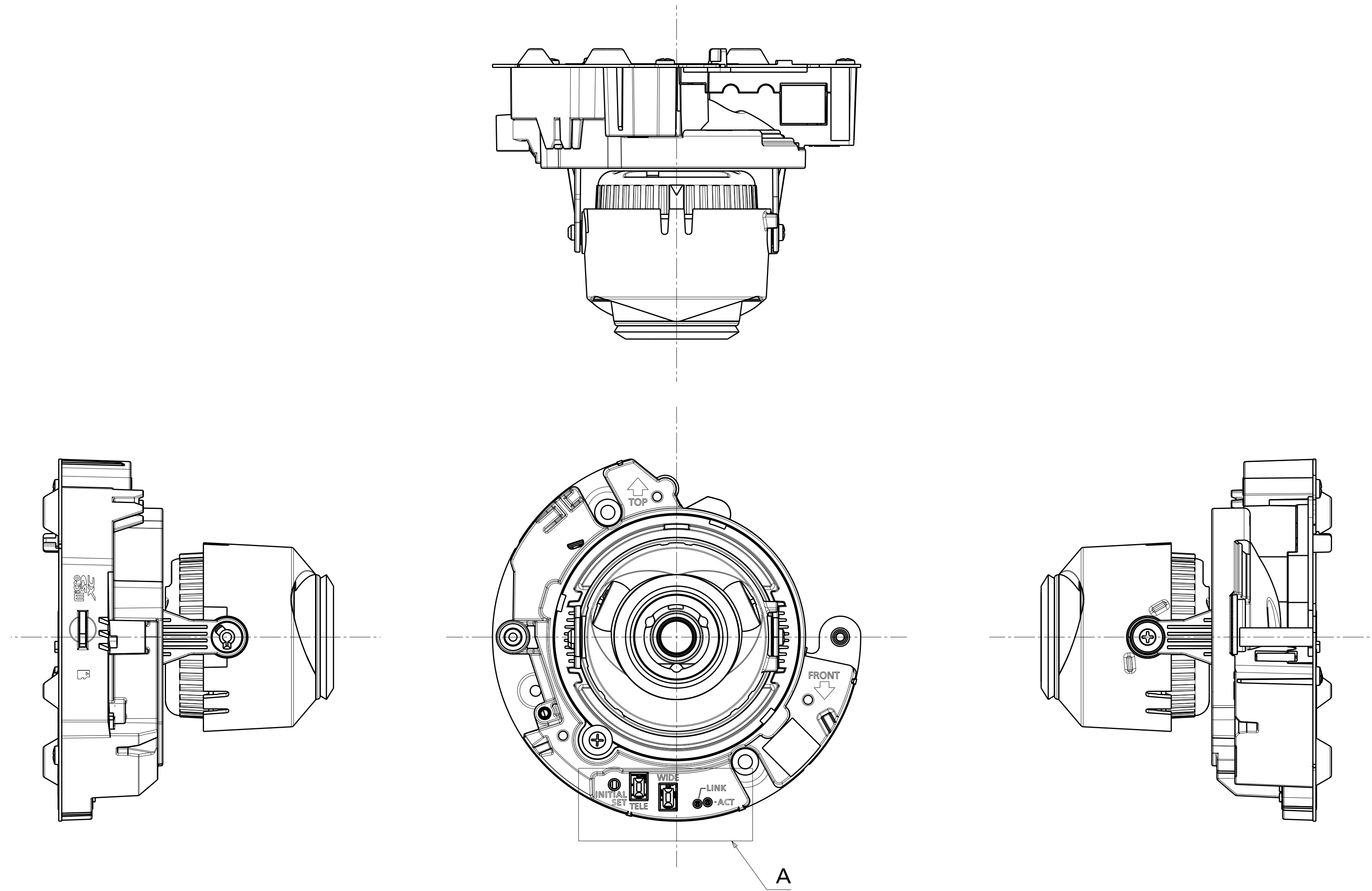

Without Enclosure

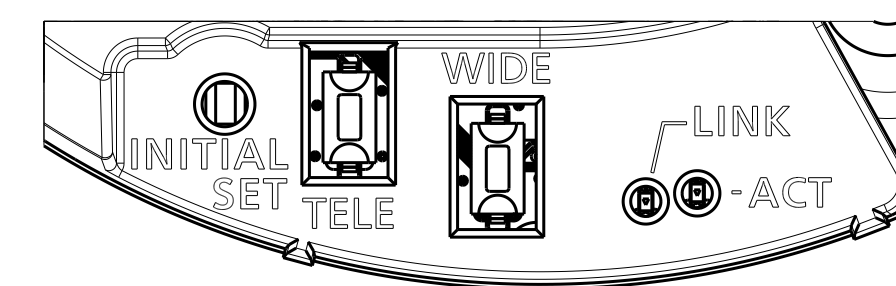

Detail A (2:1)

Model number
WV-U2132LA
WV-U2132LAV

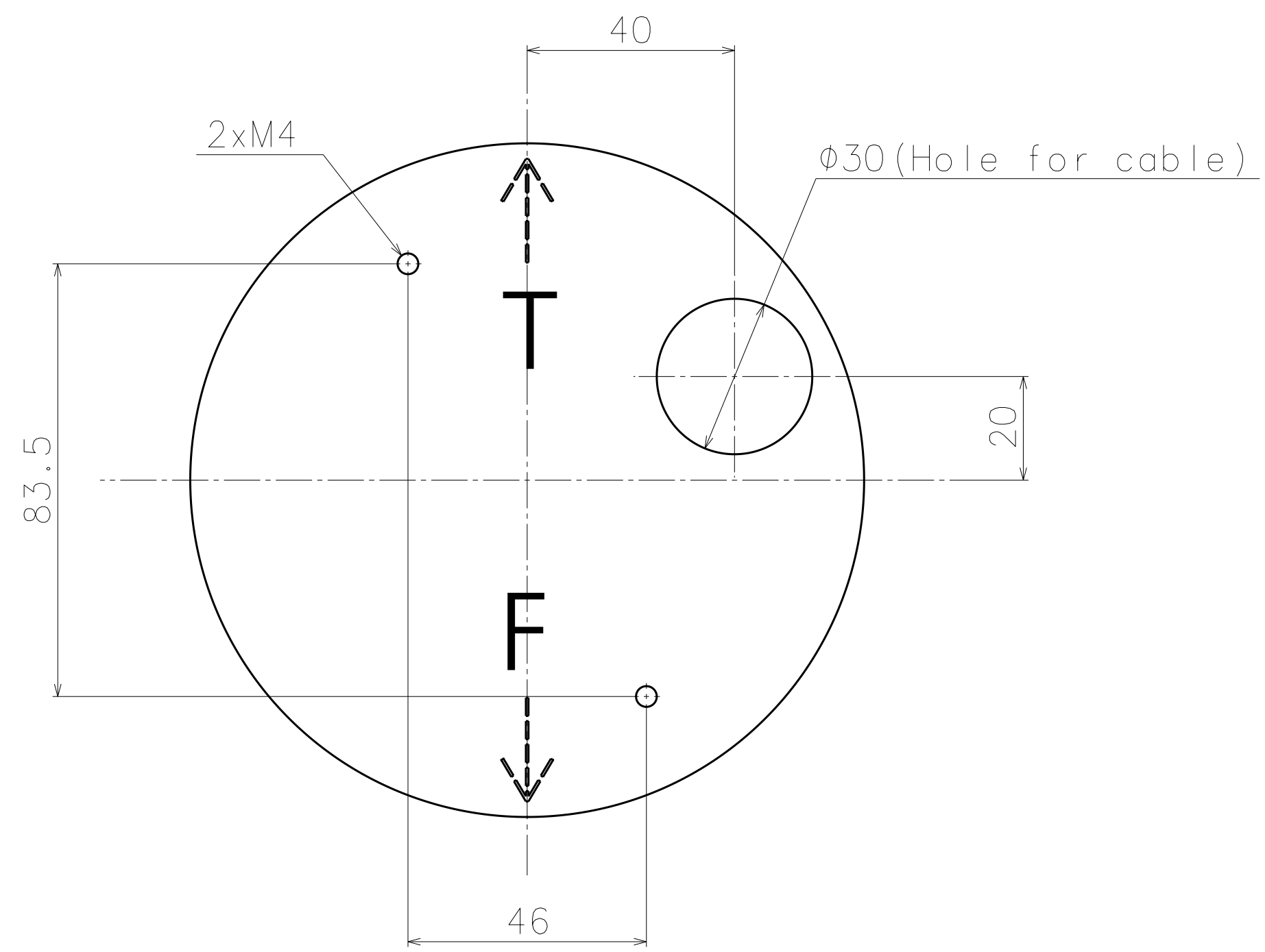

Template for mounting

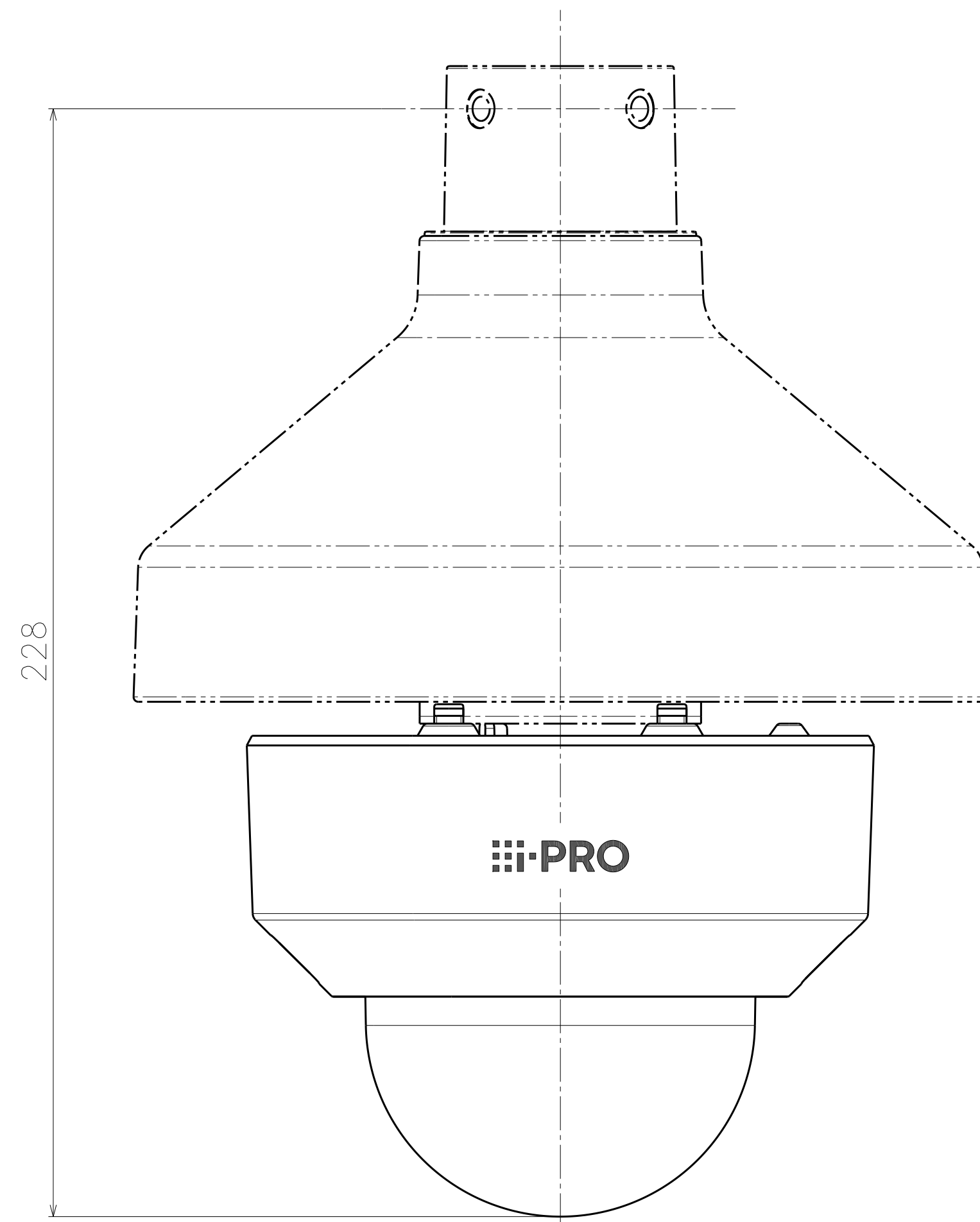

Attach to WV-QSR501-W

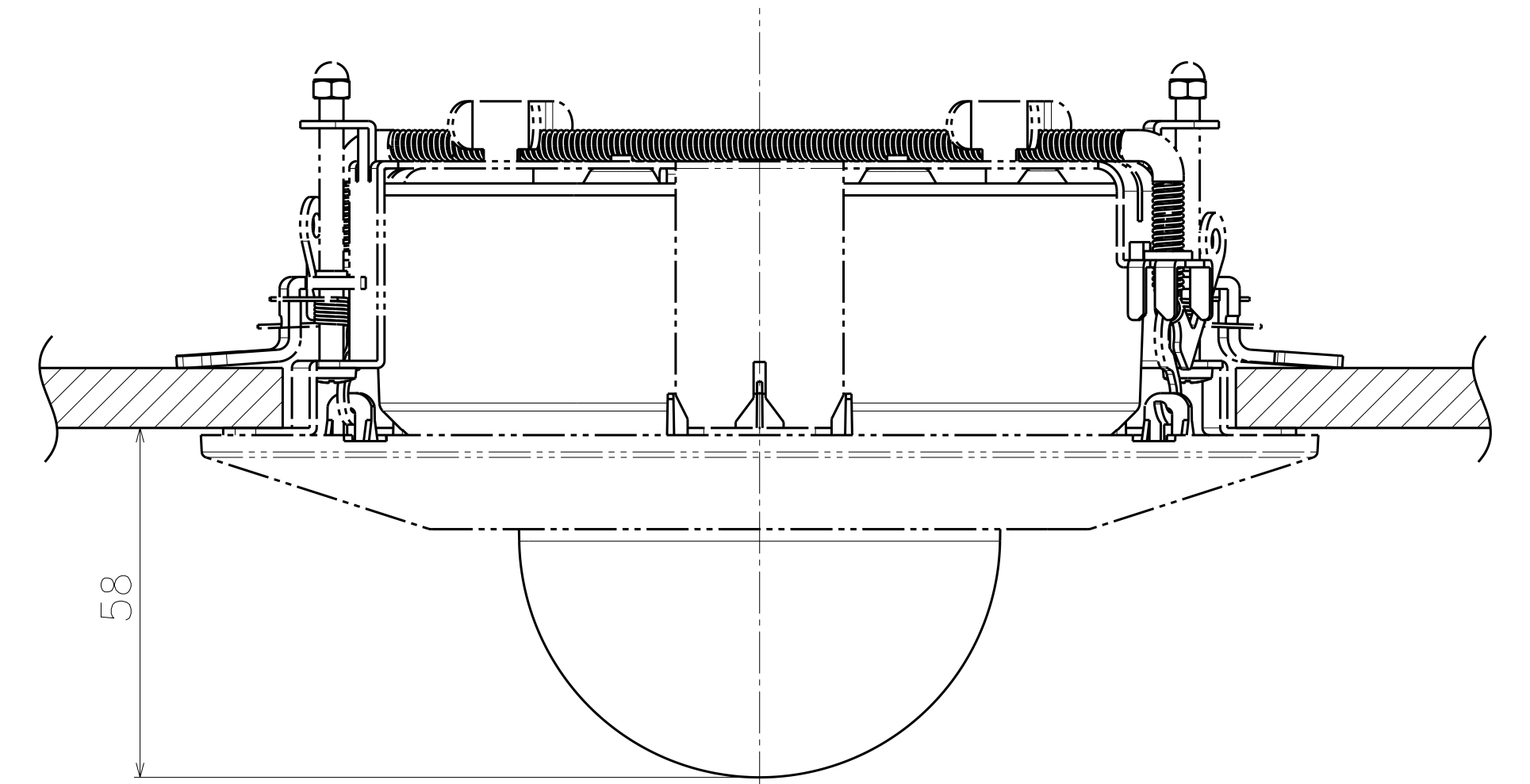

Attach to WV-QEM100-W

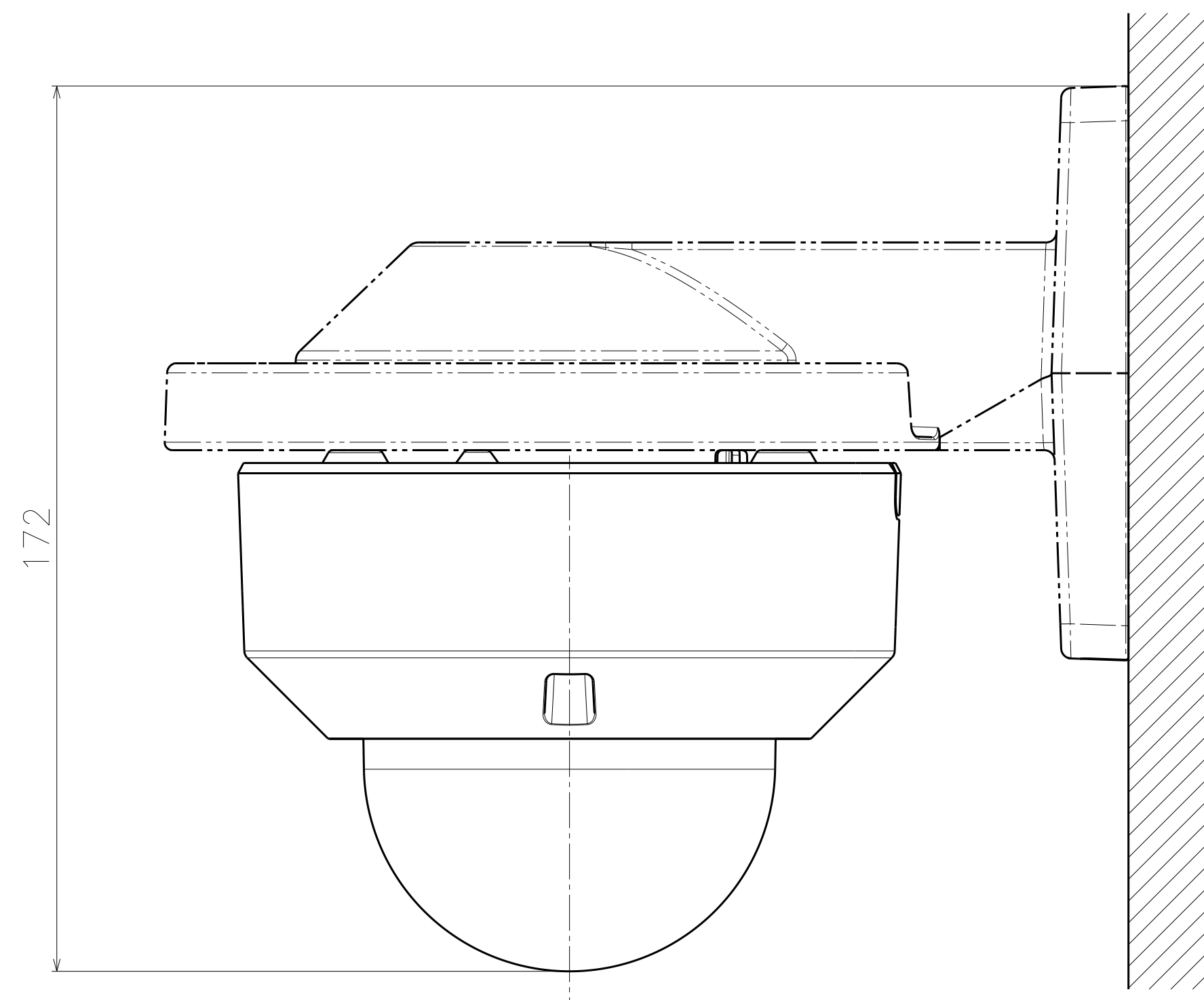

Attach to WV-QWL500-W

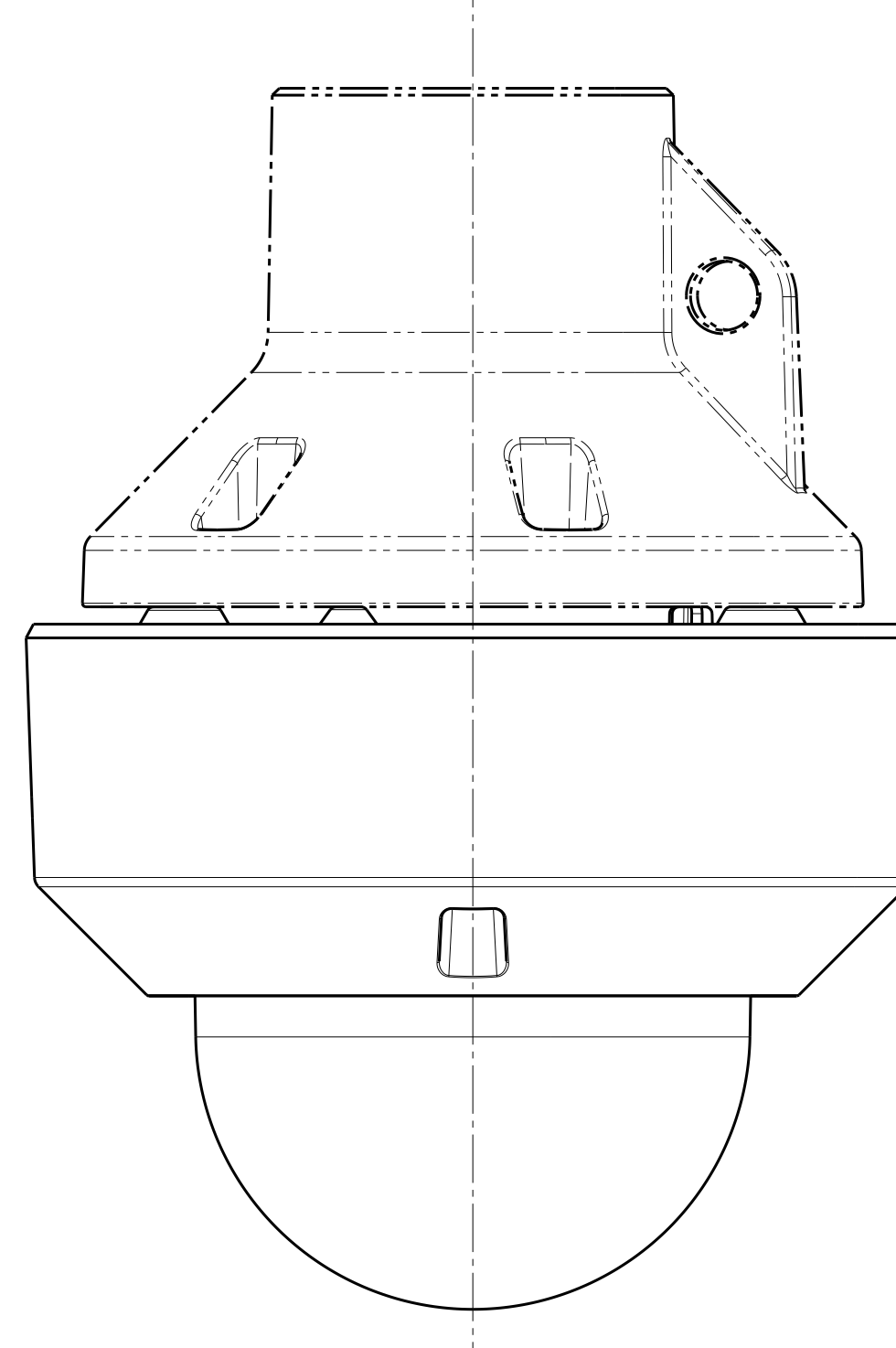

Attach to WV-QCL100-W

Model number
WV-U2132LA
WV-U2132LAV