

Mass : Approx. 350 g {0.77 lbs}

WV-U2132LA

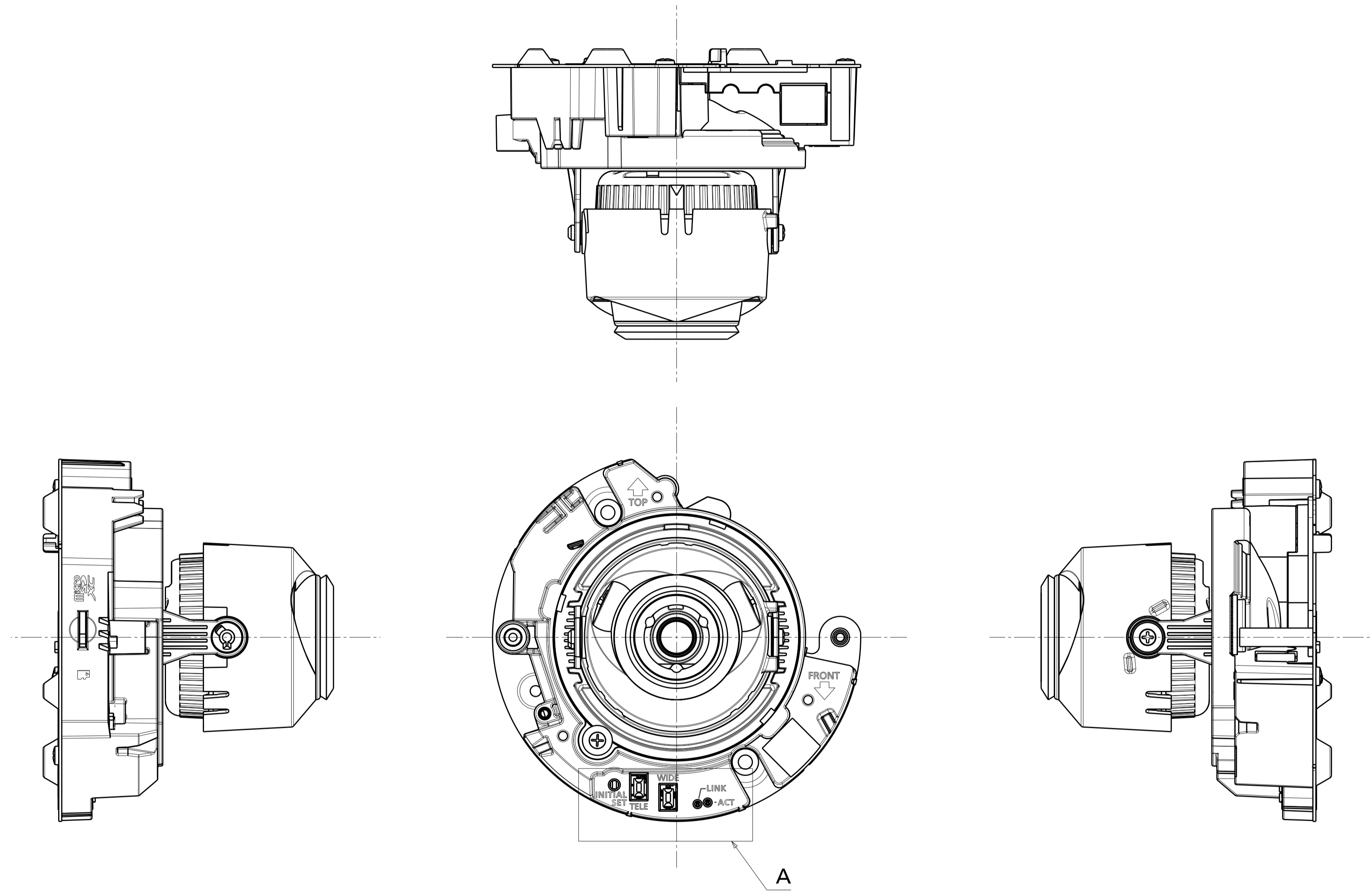

Without Enclosure

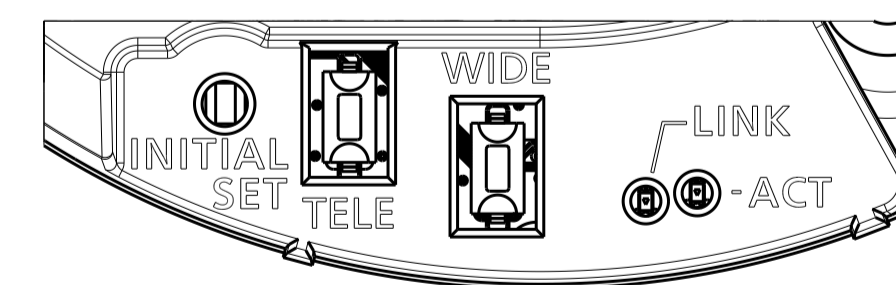

Detail A (2:1)

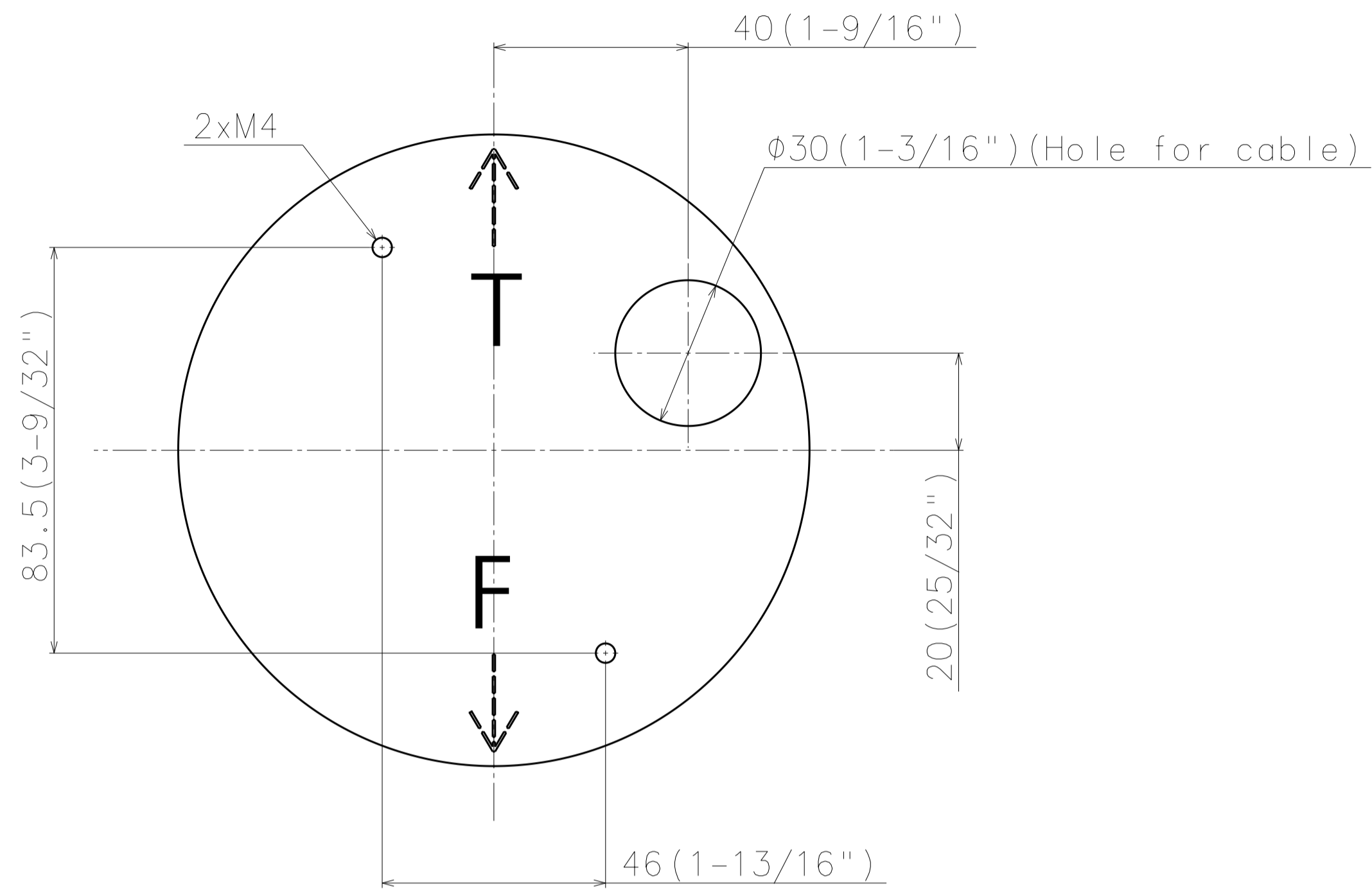

Template for mounting

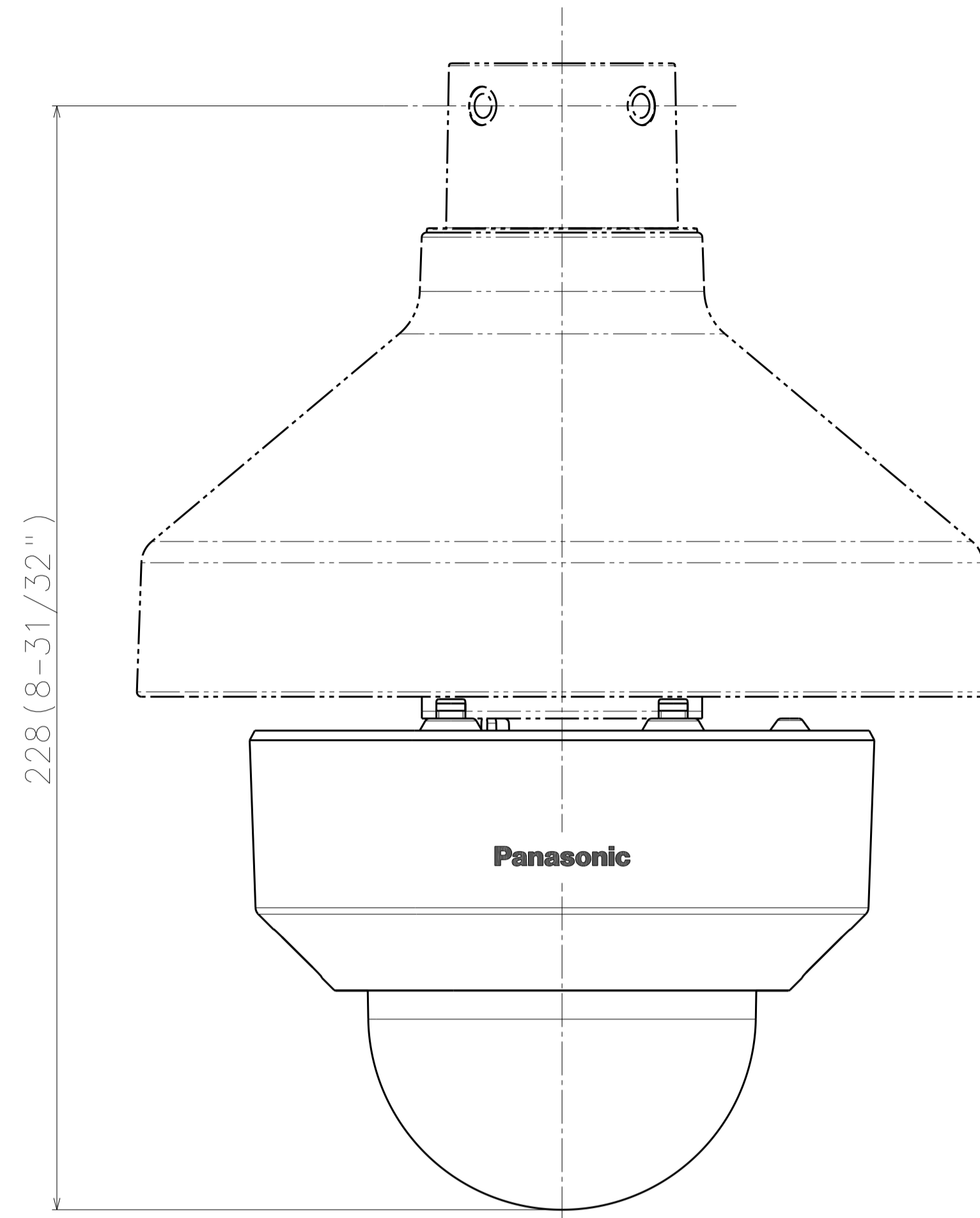

Attach to WV-QSR501-W

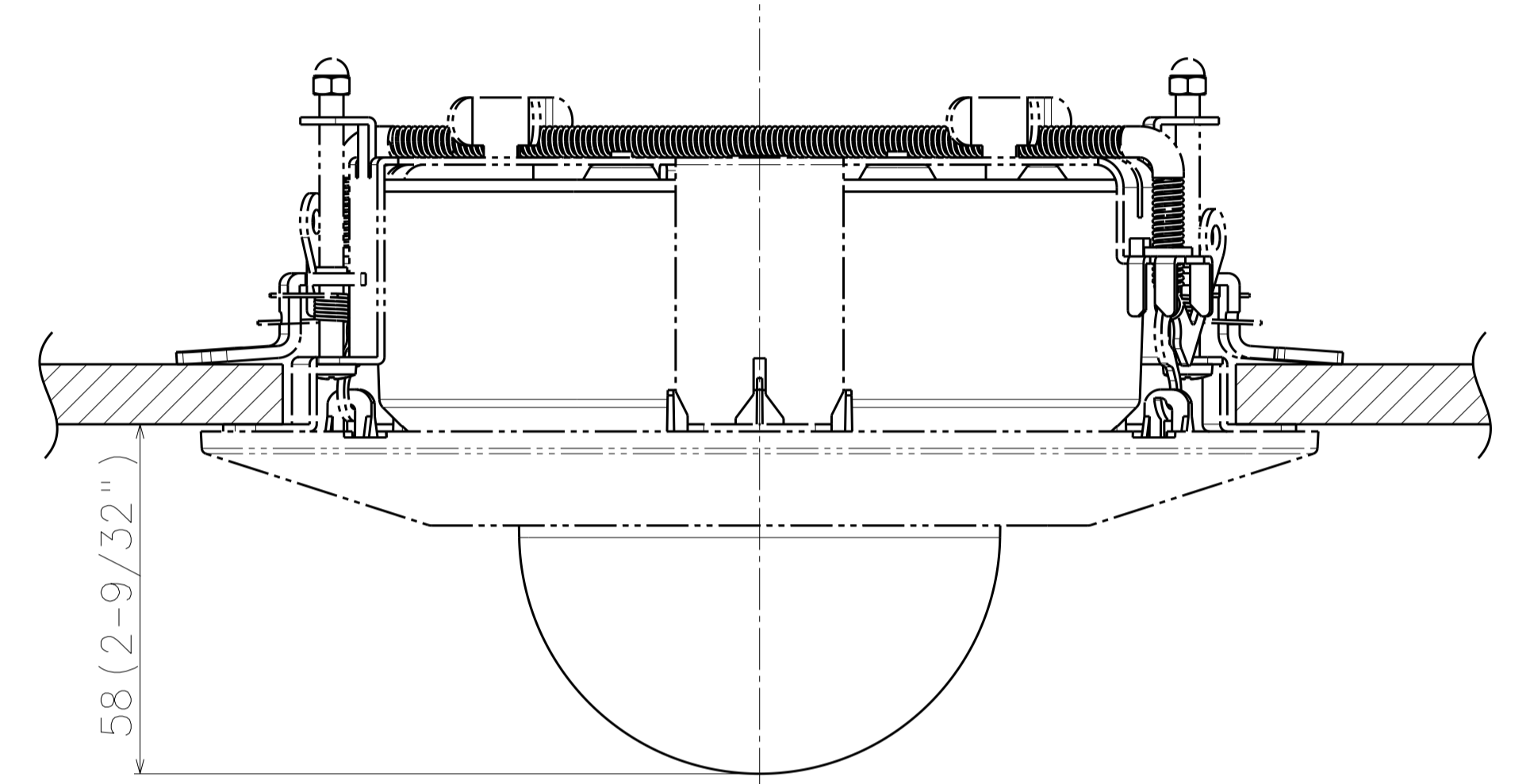

Attach to WV-QEM100-W

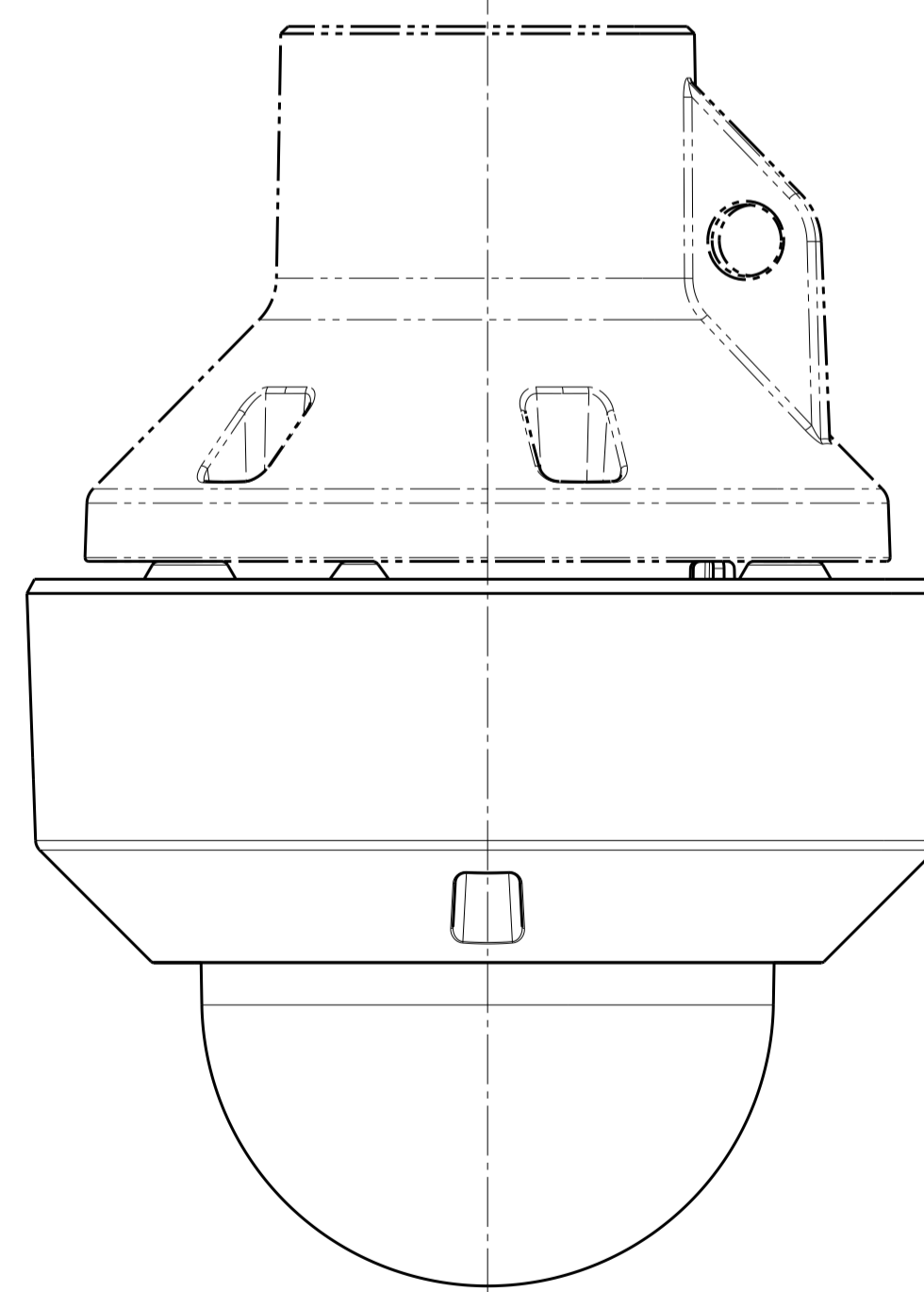

Attach to WV-QCL100-W

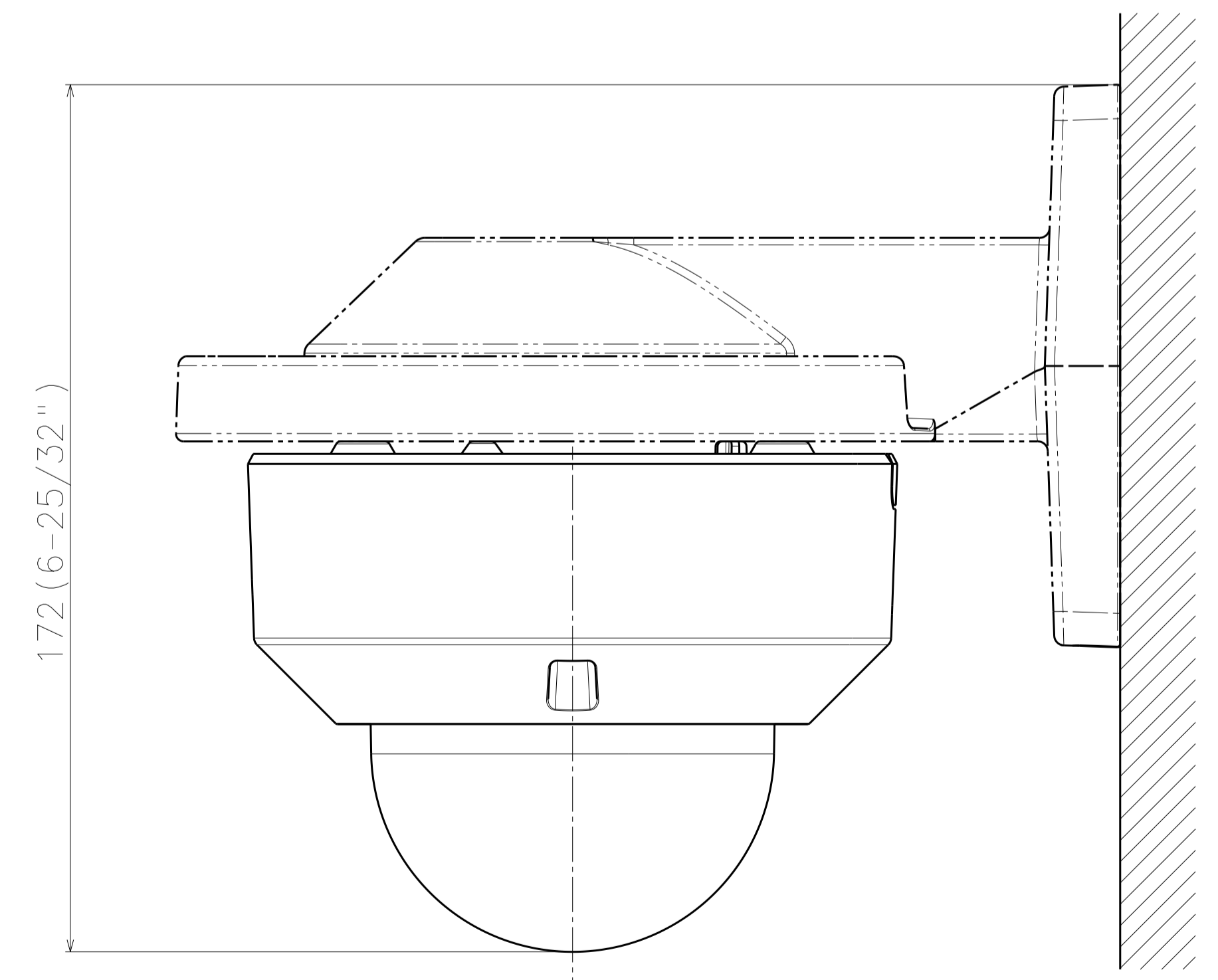

Attach to WV-QWL500-W

WV-U2132LA