

Model number
 WV-U1542LA
 WV-U1542LAV

	投影面積/Projected area
正面図/Front view	0.014 (m ²)
平面図/Top-view	0.017 (m ²)

Mass : Approx. 860 g {1.90 lbs}

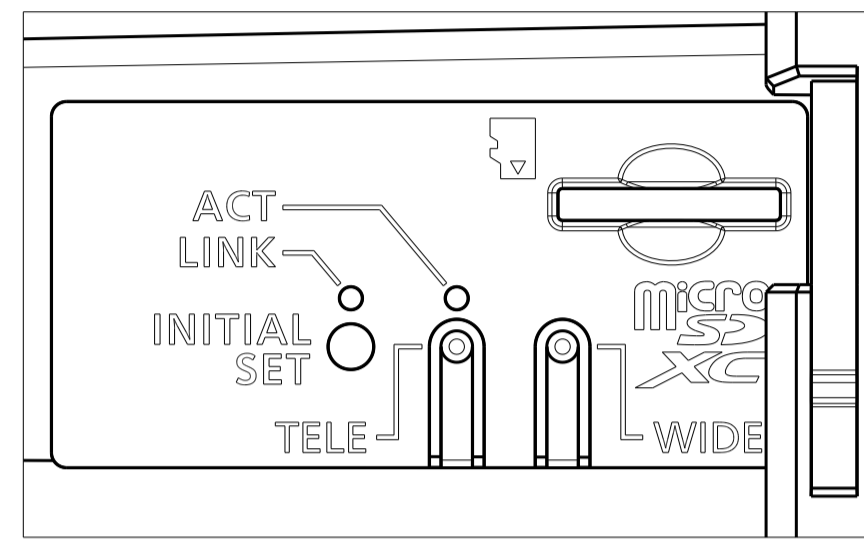

Detail A (2:1)

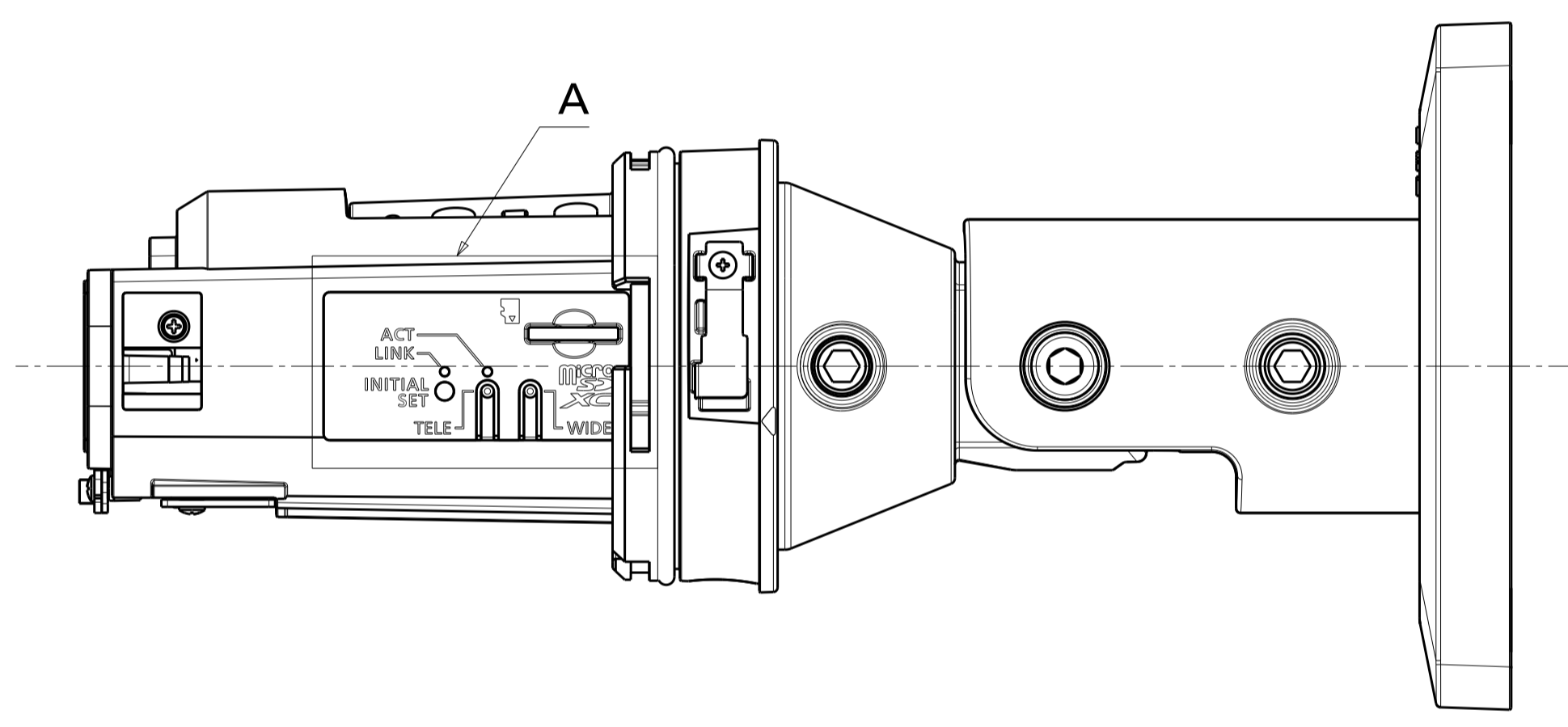
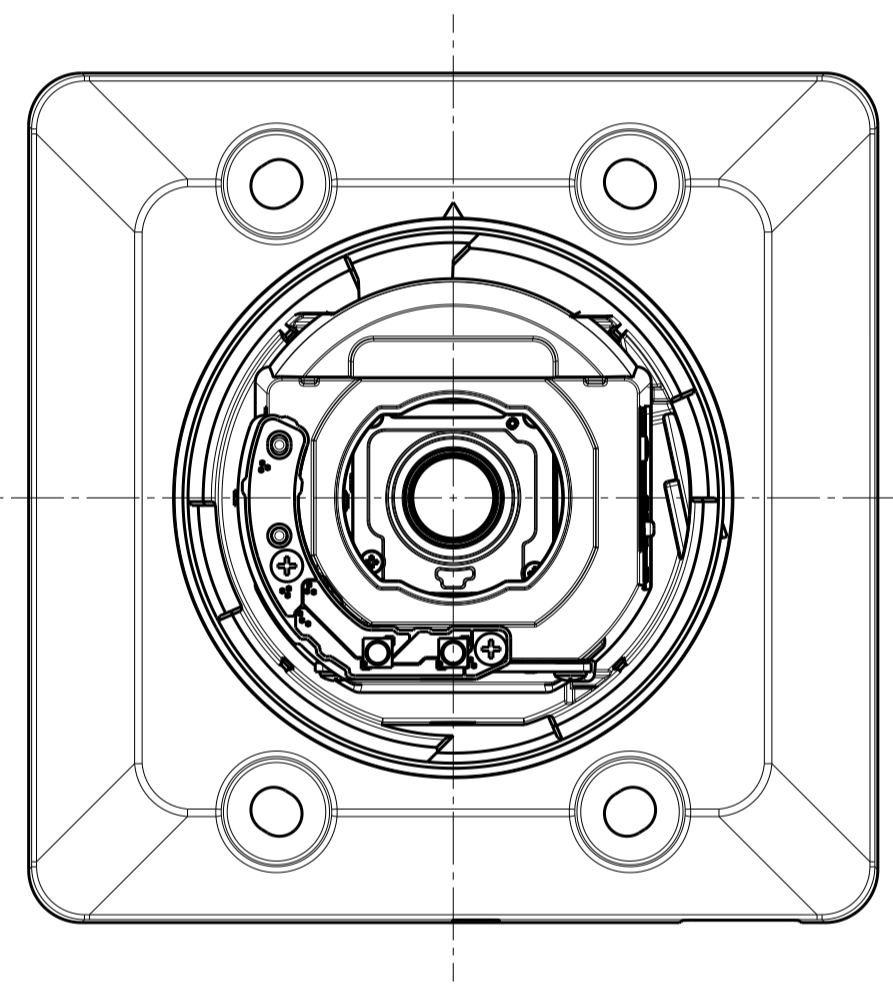

Without Enclosure

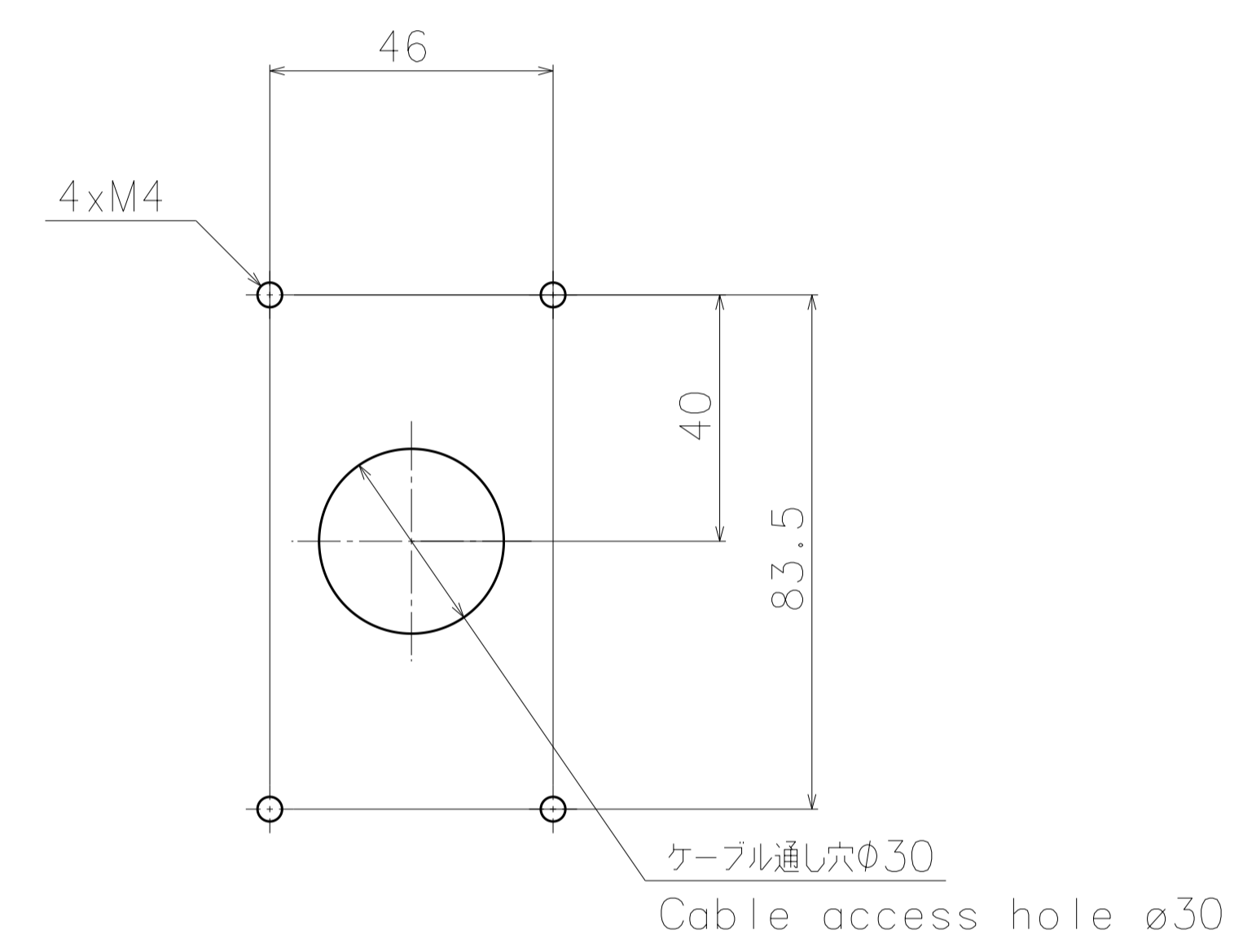

カメラ取り付け位置
Camera mounting position

Model number
WV-U1542LA
WV-U1542LAV

Attach to WV-QJB500-W

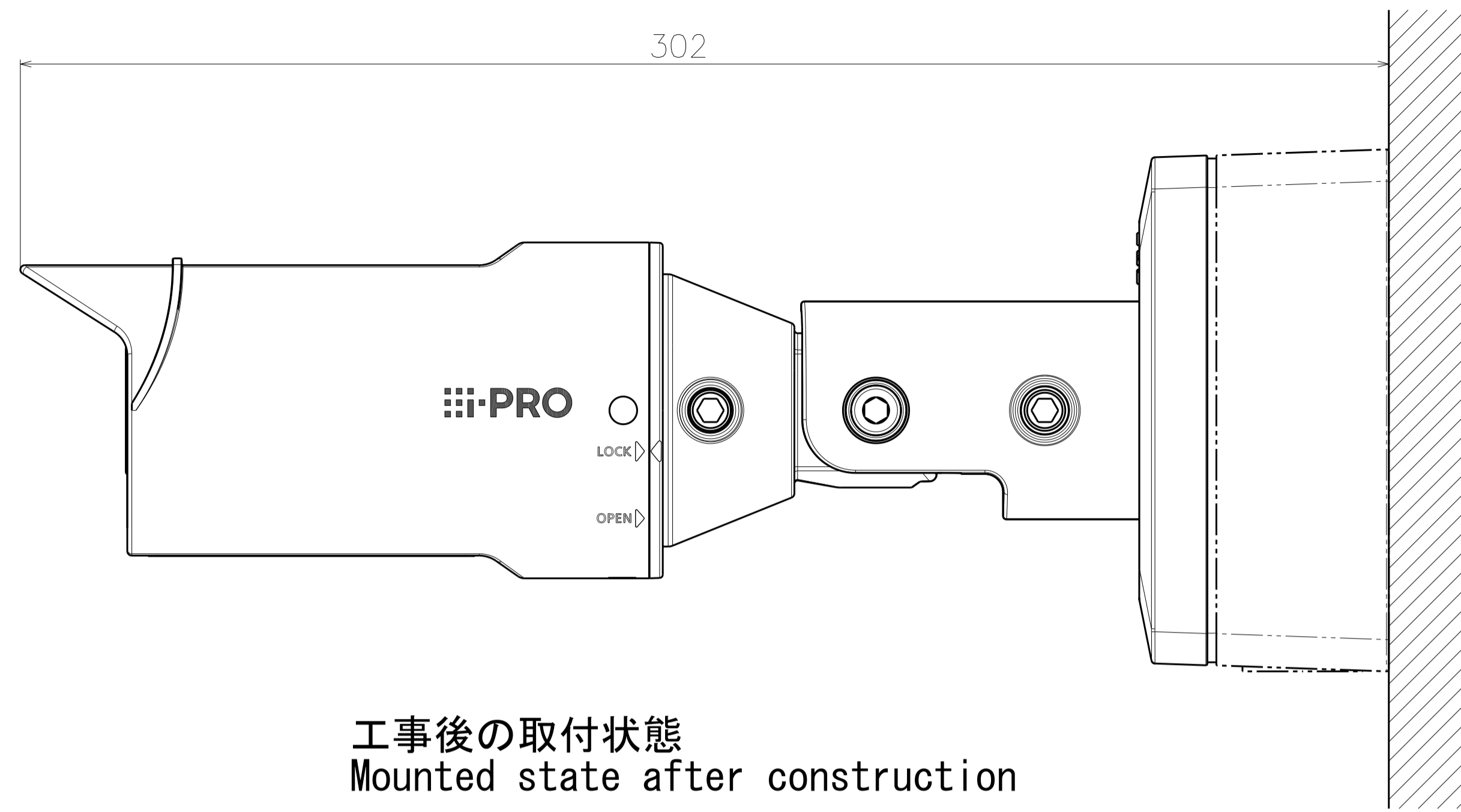

工事後の取付状態
Mounted state after construction

	投影面積/Projected area
正面図/Front view	0.019 (m ²)
平面図/Top-view	0.022 (m ²)

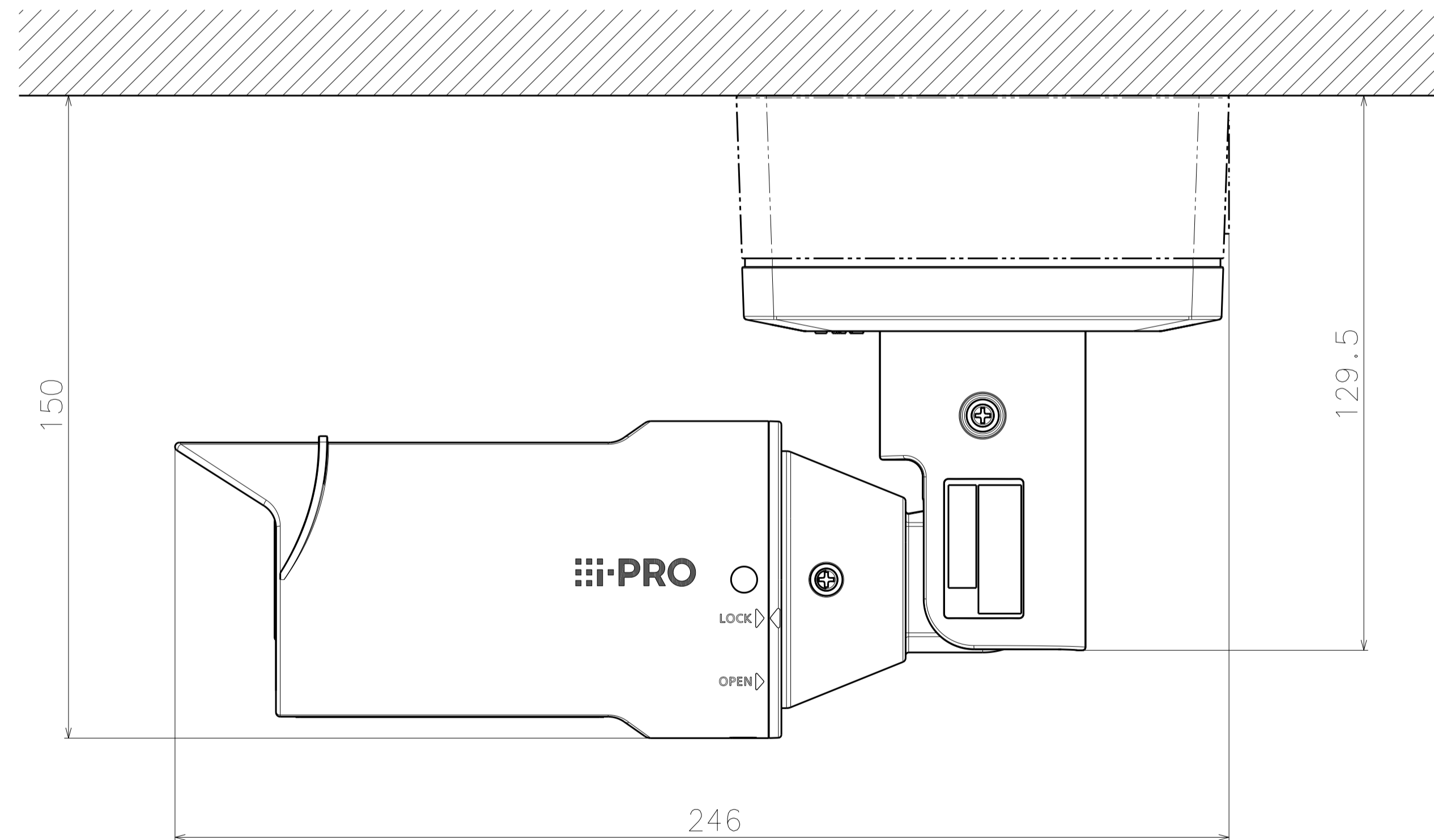
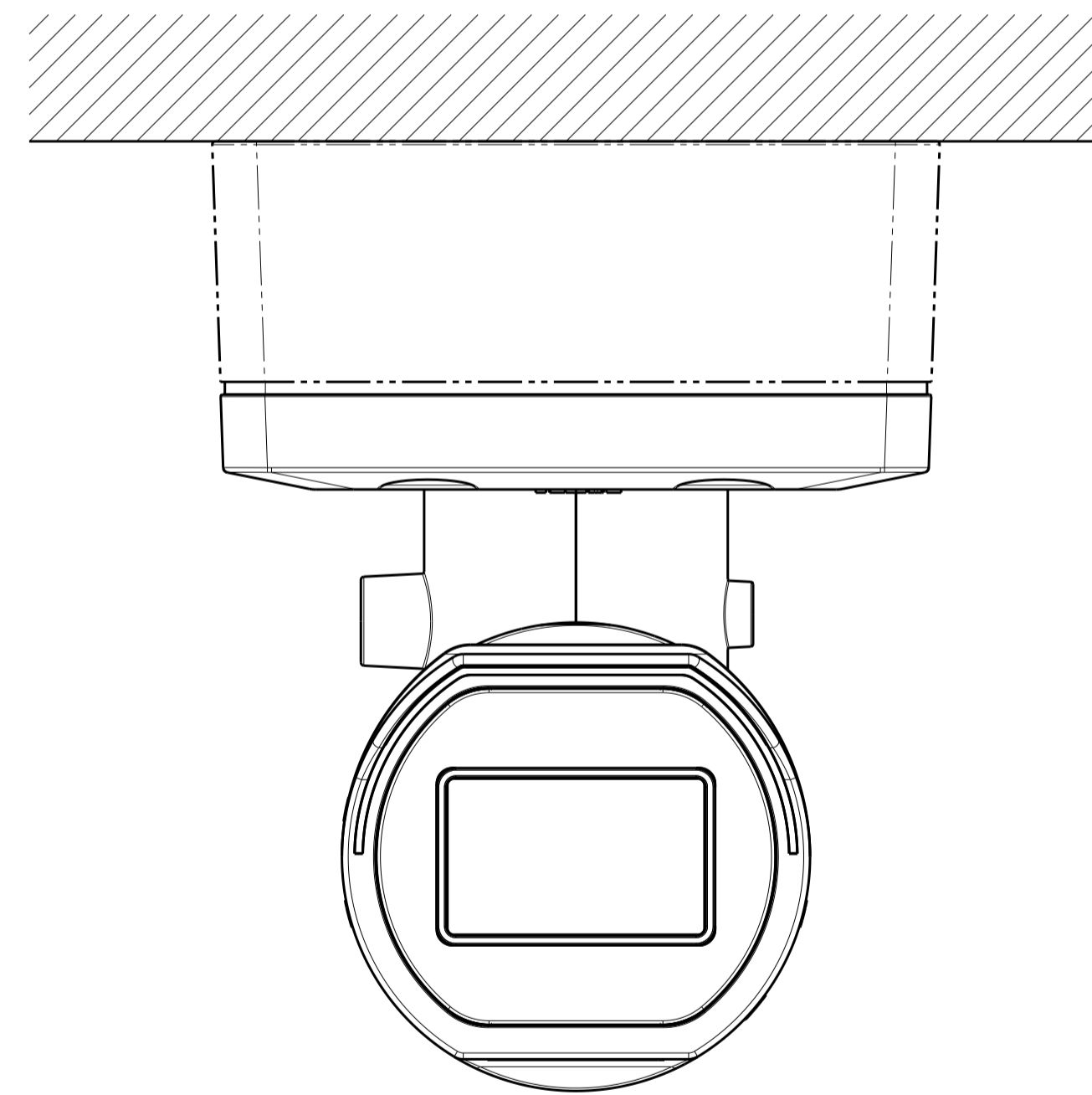

工事後の取付状態
Mounted state after construction

	投影面積/Projected area
正面図/Front view	0.019 (m ²)
側面図/Side-view	0.012 (m ²)

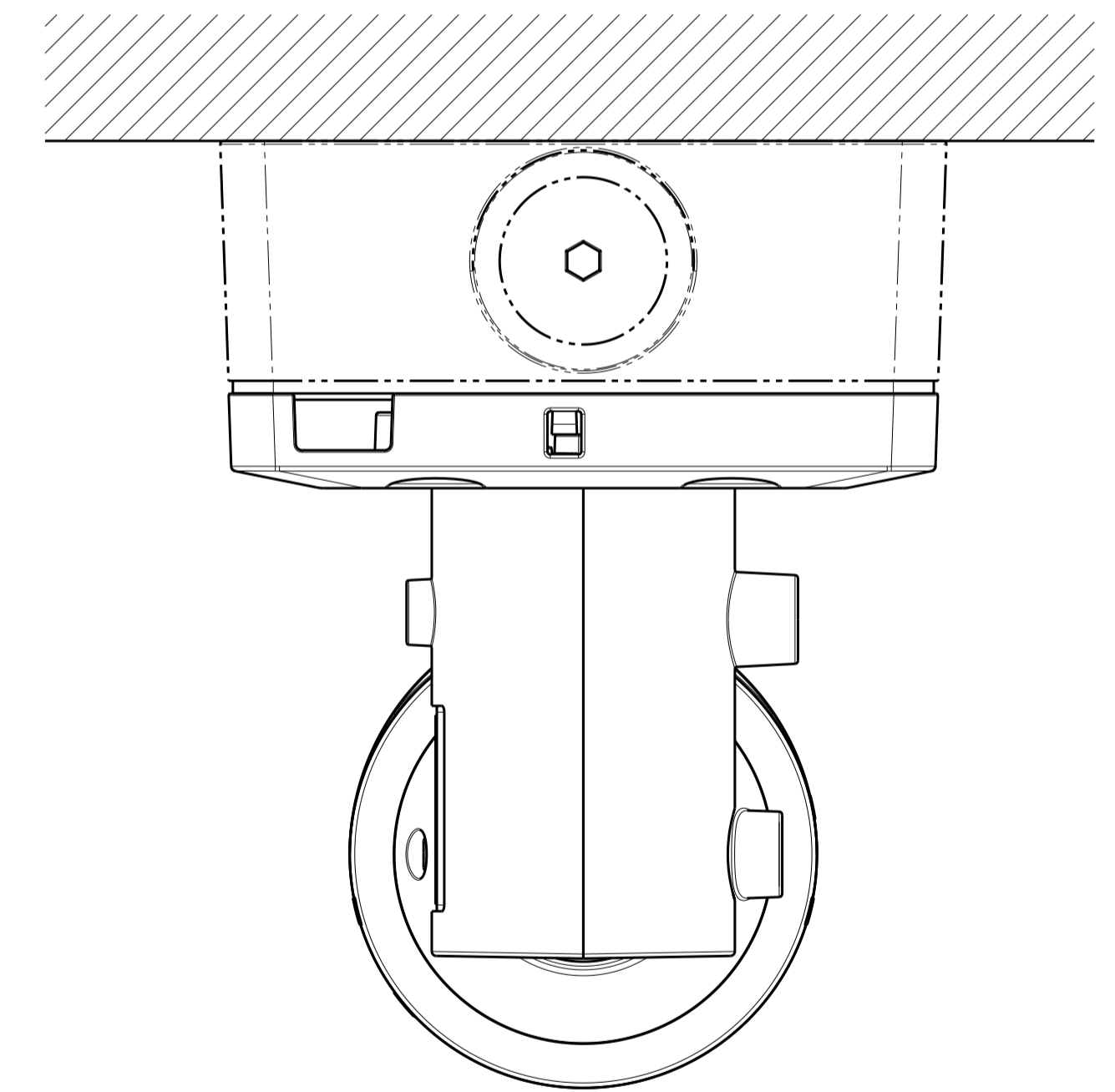

Model number
WV-U1542LA
WV-U1542LAV