

Weight : Approx. 470 g {1.04 lbs}

WV-S2135

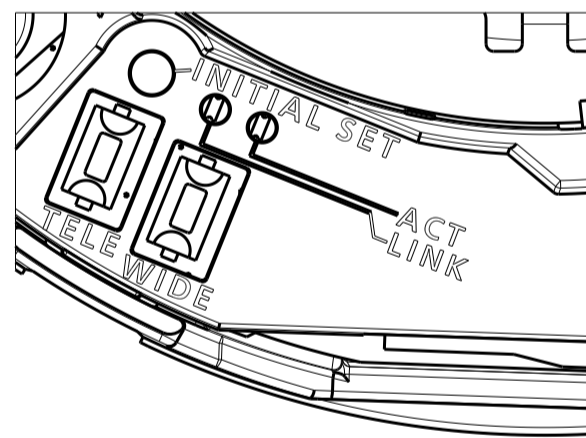

DetailA (2:1)

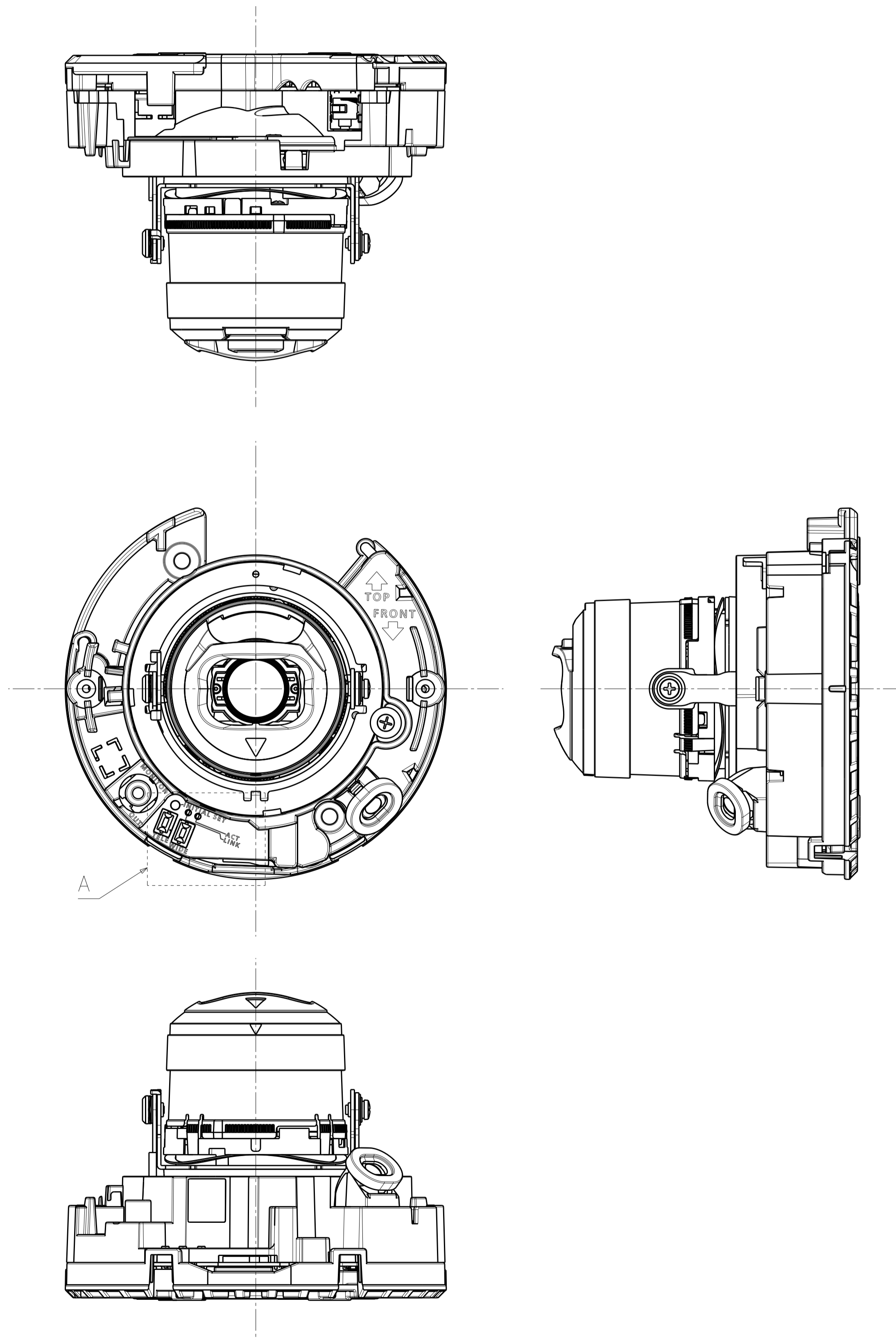

Without Enclosure

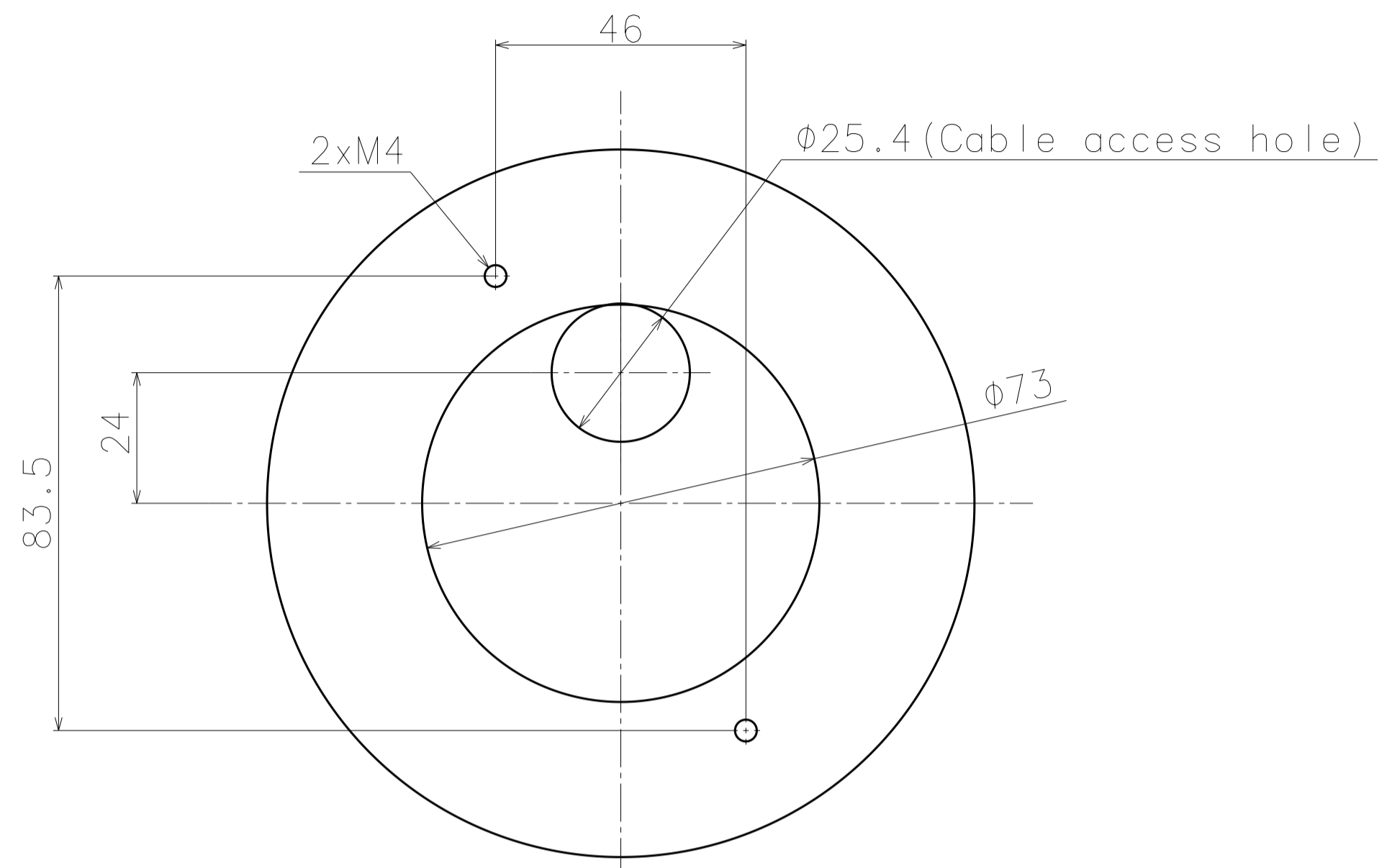

Template for mounting

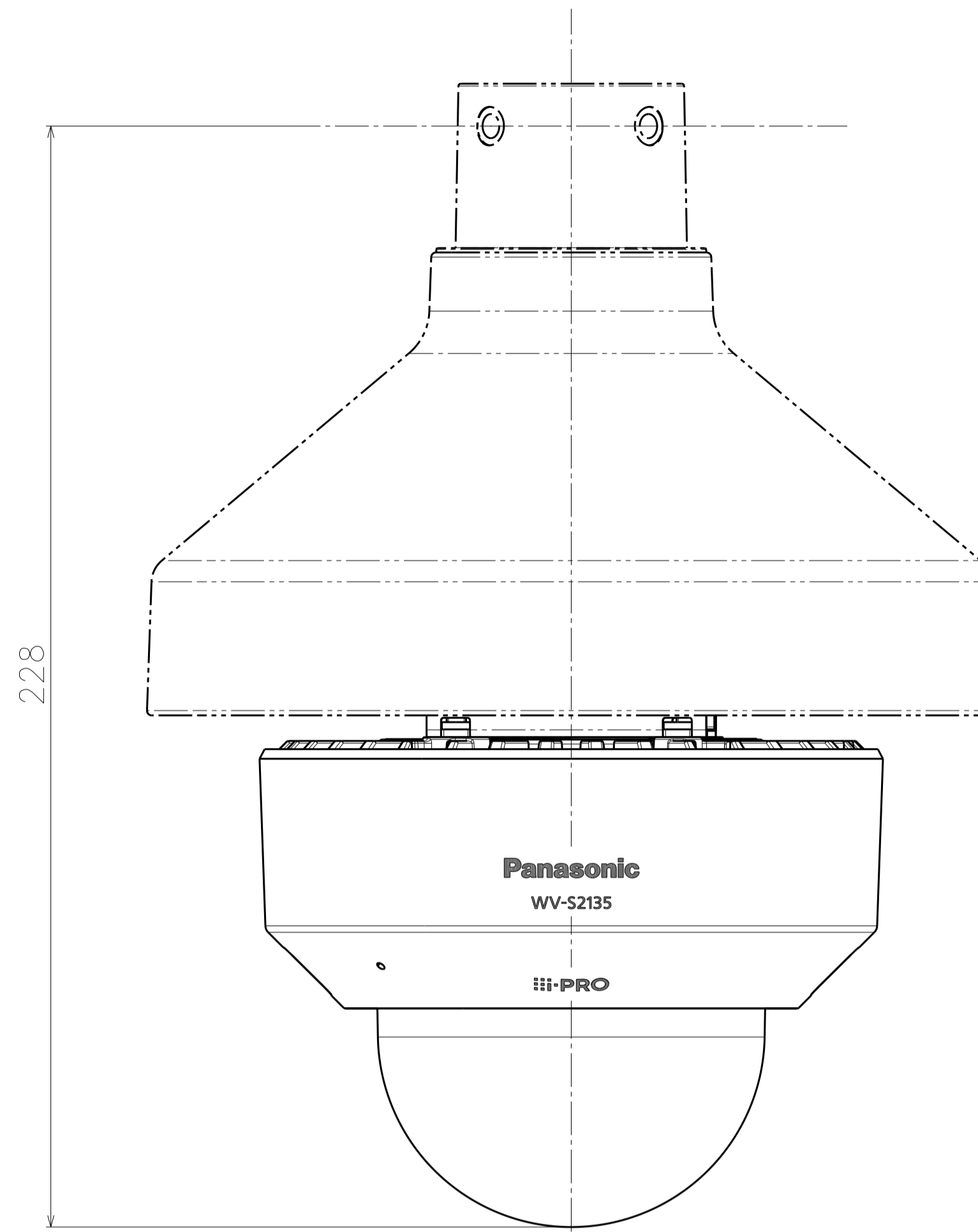

Attach to WV-QSR501-W

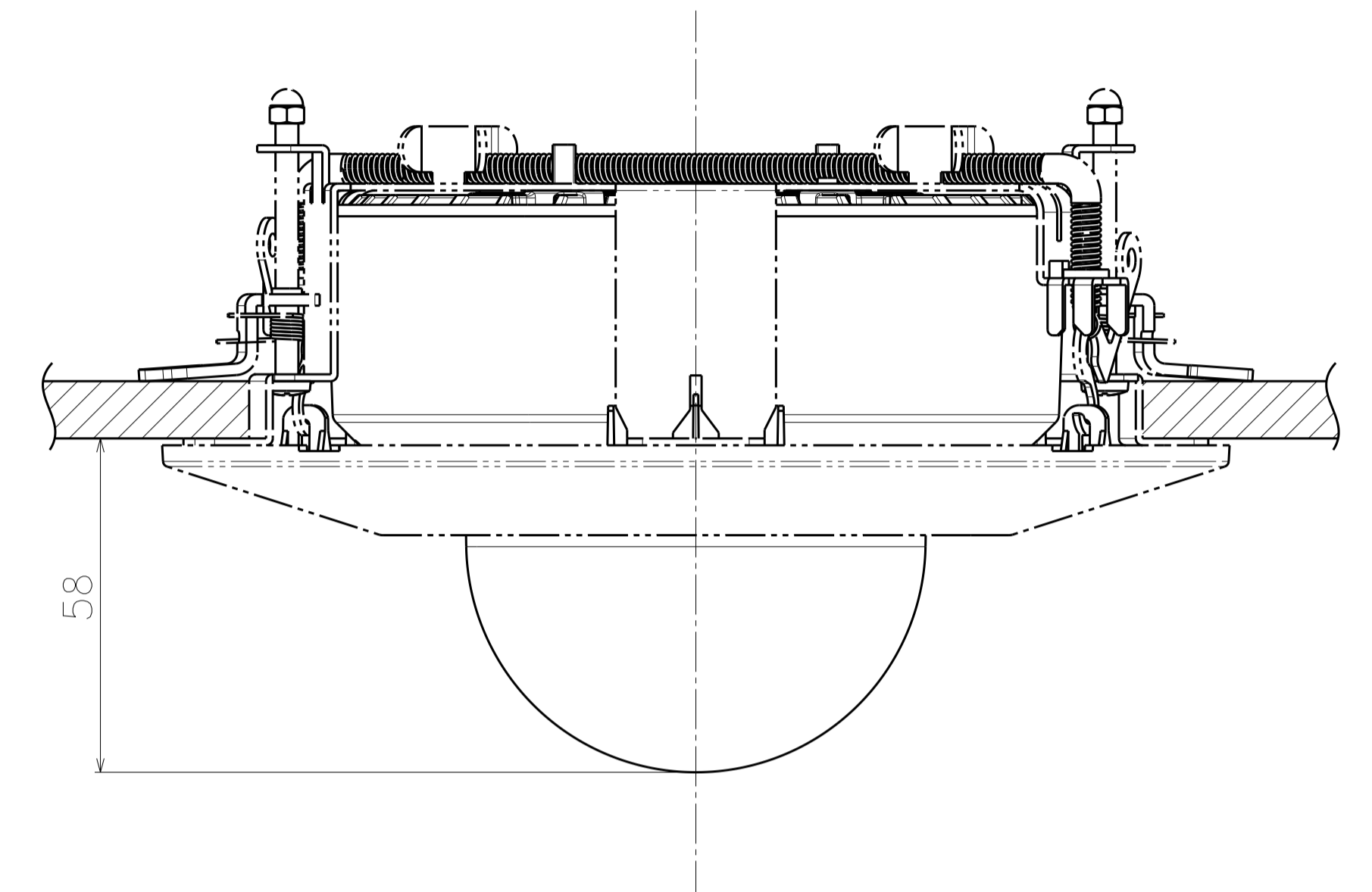

Attach to WV-QEM100-W

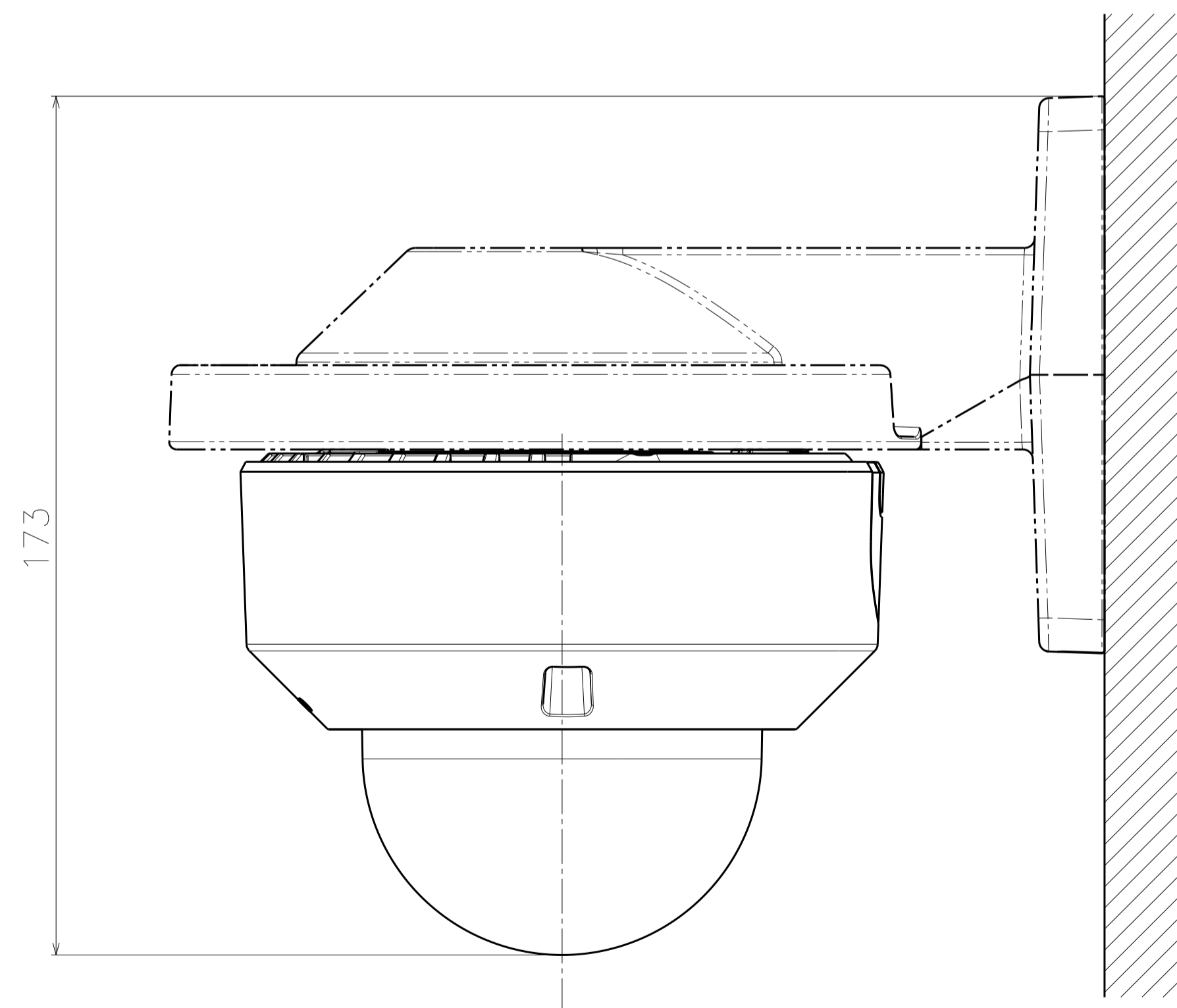

Attach to WV-QWL500-W

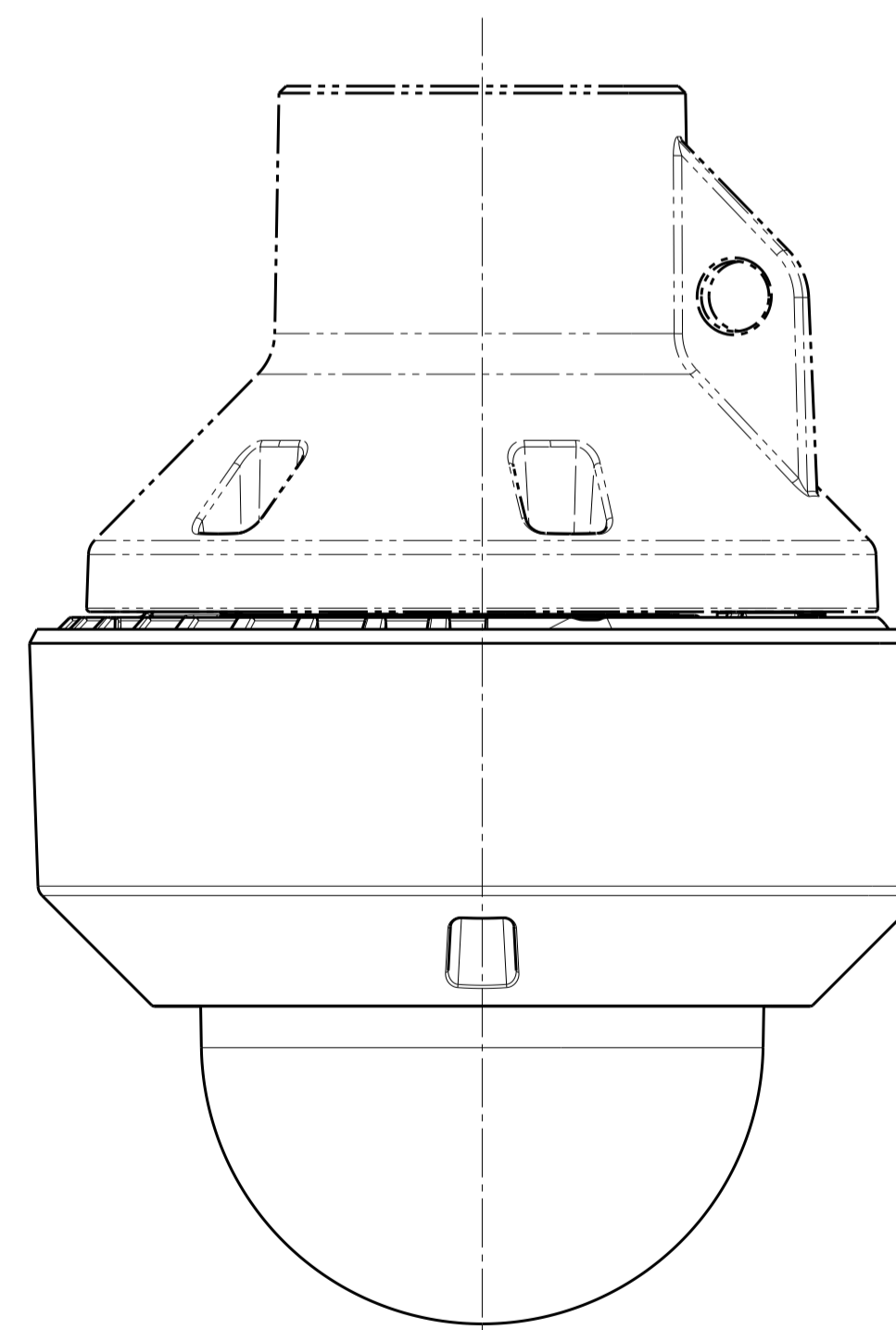

Attach to WV-QCL100-W