

## Overview

- 4 Megapixel IR
- True WDR 120dB
- 2.8mm Lens
- Built-In Mic
- H.265
- Indoor Camera





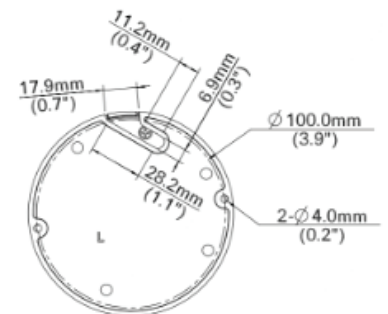
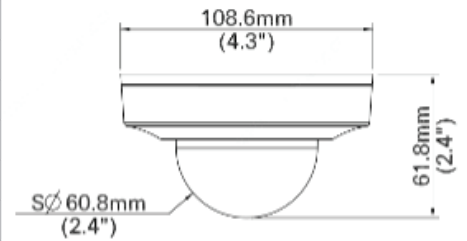

## Technical Specifications

Device	
Image Sensor:	1/2.7", 4.0 Megapixel, Progressive Scan, CMOS
Min Illumination:	Color: 0.003Lux (F1.6, AGC ON)   0Lux with IR
Shutter Time:	Auto/Manual, 1 ~ 1/100000s
Lens:	2.8mm@F1.6
WDR:	120 dB
Angle of View:	H: 101.1°, V: 55.3°, 111.1°
Angle Adjustment:	Pan: 0° ~ 348°   Tilt: -66° ~ 66°   Rotate: 0° ~ 346°
3-Axis Adjustment:	Yes
Day & Night:	IR-Cut Filter with Auto Switch (ICR)
IR Range:	Up to 30m (98ft) IR range
Compression Standard	
Video Compression:	Ultra 265, H.265, H.264, MJPEG
Video Bit Rate:	128 Kbps~16 Mbps
Tri-Stream:	Yes
Analytics:	Intrusion, Human Body Detection, Motion Detection, Tampering Alarm, Audio Detection
Image	
Max. Image Resolution:	2688 x 1520
Frame Rate:	30fps (2688 x 1520)
ROI Codec:	Up to 8 areas
Image Setting:	White Balance, Digital Noise Reduction, Smart IR, Flip, HLC, BLC, Defog



## Technical Specifications

Network	
Alarm Channels:	1 Channel In   1 Channel Out
Protocols:	IPv4, IGMP, ICMP, ARP, TCP, UDP, DHCP, RTP, RTSP, RTCP, DNS, DDNS, NTP, FTP, UPnP, HTTP, HTTPS, SMTP, SSL, QoS
Interface	
Communication Interface:	10M/100M Base-TX Ethernet
Local Storage:	Micro SD, up to 256GB
Audio:	Input: Impedance 35kΩ; Amplitude 2V [p-p] Output: Impedance 600Ω; Amplitude 2V [p-p]
General	
Safety	IEC 62368-1 EN 62368-1 UL 62368-1
EMC	FCC CFR 47 Part 15 EN 55032:2015 EN 55024:2010 EN 61000-3-2:2014 EN 61000-3-3-2013
Operating Conditions:	Temperature: -30°C ~ 55°C (-22°F ~ 131°F), Humidity: ≤95% RH (Non-Condensing)
Power Consumption:	Max 4.5W
Power Supply:	DC 12V±25%, PoE (IEEE 802.3af)
Weather Proof Rating:	–
Vandal Resistant:	–
Dimensions:	Φ109 x 62mm (Ø4.3" x 2.4")
Weight:	0.22kg (0.49lb)
Software:	Includes Video Insight VMS License
Accessories	
	<div style="display: flex; justify-content: space-around; align-items: flex-start;"> <div style="text-align: center;"> <p>M-JB-MINI</p>  </div> <div style="text-align: center;"> <p>M-WM-JB-MINI</p>  </div> <div style="text-align: center;"> <p>M-PM</p>  </div> </div> <div style="display: flex; justify-content: space-around; align-items: flex-start; margin-top: 20px;"> <div style="text-align: center;"> <p>M-Pendant-Ex</p>  </div> <div style="text-align: center;"> <p>M-Pendant</p>  </div> </div>

R071222 | Product specifications and availability are subject to change without notice.

© i-PRO Co., Ltd. All Rights Reserved. i-PRO, Viewnetcam.com, Advidia, VideoInsight, CloUDE, and Unified Digital Evidence are registered trademarks or trademarks of i-PRO Co., Ltd. or i-PRO Americas Inc. in various jurisdictions. All other trademarks are the property of their respective owners.