

Panasonic[®]

Operating Instructions

Included Installation Instructions

Extension Unit

Model No. **WV-SPN6R481**

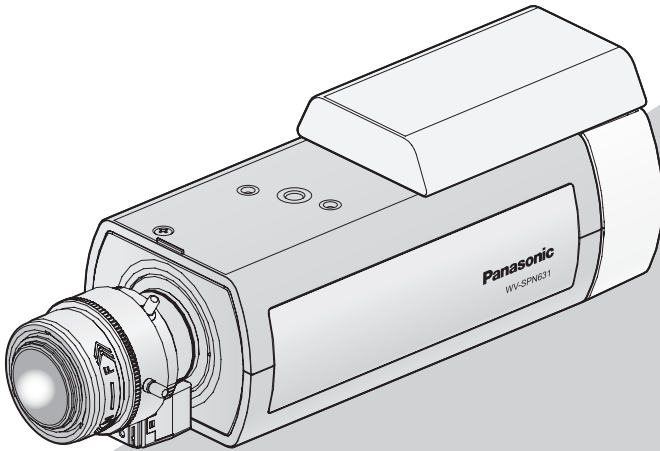

Before attempting to connect or install this product,
please read these instructions carefully and save this manual for future use.

The model number is abbreviated in some descriptions in this manual.

For Canada

CAN ICES-3(A)/NMB-3(A)

For U.S.A.

NOTE: This equipment has been tested and found to comply with the limits for a Class A digital device, pursuant to Part 15 of the FCC Rules. These limits are designed to provide reasonable protection against harmful interference when the equipment is operated in a commercial environment. This equipment generates, uses, and can radiate radio frequency energy and, if not installed and used in accordance with the instruction manual, may cause harmful interference to radio communications. Operation of this equipment in a residential area is likely to cause harmful interference in which case the user will be required to correct the interference at his own expense.

FCC Caution: To assure continued compliance, (example - use only shielded interface cables when connecting to computer or peripheral devices). Any changes or modifications not expressly approved by the party responsible for compliance could void the user's authority to operate this equipment.

For U.S.A.

The model number and serial number of this product may be found on the surface of the unit.

You should note the model number and serial number of this unit in the space provided and retain this book as a permanent record of your purchase to aid identification in the event of theft.

Model No. _____

Serial No. _____

For Europe

We declare under our sole responsibility that the product to which this declaration relates is in conformity with the standard or other normative document following the provisions of Directive 2004/108/EC.

Wir erklären in alleiniger Verantwortung, daß das Produkt, auf das sich diese Erklärung bezieht, mit der folgenden Norm oder normativen Dokument übereinstimmt. Gemäß den Bestimmungen der Richtlinie 2004/108/EC.

Nous déclarons sous notre propre responsabilité que le produit auquel se réfère la présente déclaration est conforme à la norme spécifiée ou à tout autre document normatif conformément aux dispositions de la directive 2004/108/CE.

Nosotros declaramos bajo nuestra única responsabilidad que el producto a que hace referencia esta declaración está conforme con la norma u otro documento normativo siguiendo las estipulaciones de la directiva 2004/108/CE.

Noi dichiariamo sotto nostra esclusiva responsabilità che il prodotto a cui si riferisce la presente dichiarazione risulta conforme al seguente standard o altro documento normativo conforme alle disposizioni della direttiva 2004/108/CE.

Wij verklaren als enige aansprakelijke, dat het product waarop deze verklaring betrekking heeft, voldoet aan de volgende norm of ander normatief document, overeenkomstig de bepalingen van Richtlijn 2004/108/EC.

Vi erklærer os eneansvarlige for, at dette produkt, som denne deklaration omhandler, er i overensstemmelse med standard eller andre normative dokumenter i følge bestemmelserne i direktiv 2004/108/EC.

Vi deklarerar härmed vårt fulla ansvar för att den produkt till vilken denna deklaration hänvisar är i överensstämmelse med standarddokument eller annat normativt dokument som framställs i direktiv 2004/108/EC.

Ilmoitamme yksinomaaisella vastuullamme, että tuote, jota tämä ilmoitus koskee, noudattaa seuraavaa standardia tai muuta ohjeellista asiakirjaa, jotka noudattavat direktiivin 2004/108/EC säädöksiä.

Vi erklærer oss alene ansvarlige for at produktet som denne erklæringen gjelder for, er i overensstemmelse med følgende norm eller andre normgivende dokumenter som følger bestemmelsene i direktiv 2004/108/EC.

Contents

Features..... 4
Precautions 4
Installations 5
Specifications..... 14
Standard accessories..... 14

Features

This is the RS485 Output unit for the WV-SPN6 series.
It will be referred to as RS485 Output unit from here on.

Precautions

Refer installation work to the dealer.

Installation work requires technique and experiences.

Failure to observe this may cause fire, electric shock, injury, or damage to the product.

Be sure to consult the dealer.

Turn the power off when do wiring of this product.

Failure to observe this may cause electric shock. In addition, short circuit or wrong wiring may cause fire.

The screws and bolts must be tightened to the specified torque.

Loosening of mounting screws or bolts may cause a fall of the product resulting in injury or accidents.

Stop the operation immediately when something is wrong with this product.

When smoke goes up from the product, the smell of smoke comes from the product, or the exterior of the product has deteriorated, continued use will cause a fire or fall of the product resulting in injury, or damage to the product.

In this case, turn the power off immediately and contact qualified service personnel for service.

Do not insert any foreign objects.

Fire or electrical shock may be caused if water or any foreign objects, such as metal objects, enter inside the unit.

Turn the power off immediately and contact qualified service personnel for service.

Do not attempt to disassemble or modify this product.

Failure to observe this may cause fire or electric shock.

Consult the dealer for the repair or inspections.

Correctly perform all wiring.

Short circuits in the wiring or incorrect wiring may cause fire or electrical shock.

Do not install or clean the camera, or touch this product, the power cable or the connected cables during thunder storms.

Failure to observe this may cause electric shock.

Turn the power off when cleaning this product.

Failure to observe this may cause injury.

Installations

The following mounting descriptions use model WV-SPN631 as a representative example to explain the mounting process.

Read the following descriptions together with the Installation Guide of the respective camera before attempting to mount the camera.

Step1 Remove the rear option cover fastening screw on the top of the camera, the rear option cover and the 2 screws located on the upper backside of the camera.

- 1 Remove the rear option cover fastening screw (binding head screw: M2.5 x 5 mm {1/4 inches}) on the top of the camera.
- 2 Remove the rear option cover by inserting a flat-headed object (such as a small screwdriver) into the groove on the left side (when viewed from behind) on the top of the camera body.
- 3 Remove the top 2 screws (binding head screw: M2.5 x 5 mm {1/4 inches}) from the back panel of the camera.

Note:

- Store the removed screws (binding head screw: M2.5 x 5 mm {1/4 inches}) and rear option cover in a safe location for when you choose to remove the RS485 Output unit, as they will not be used from this point onwards.

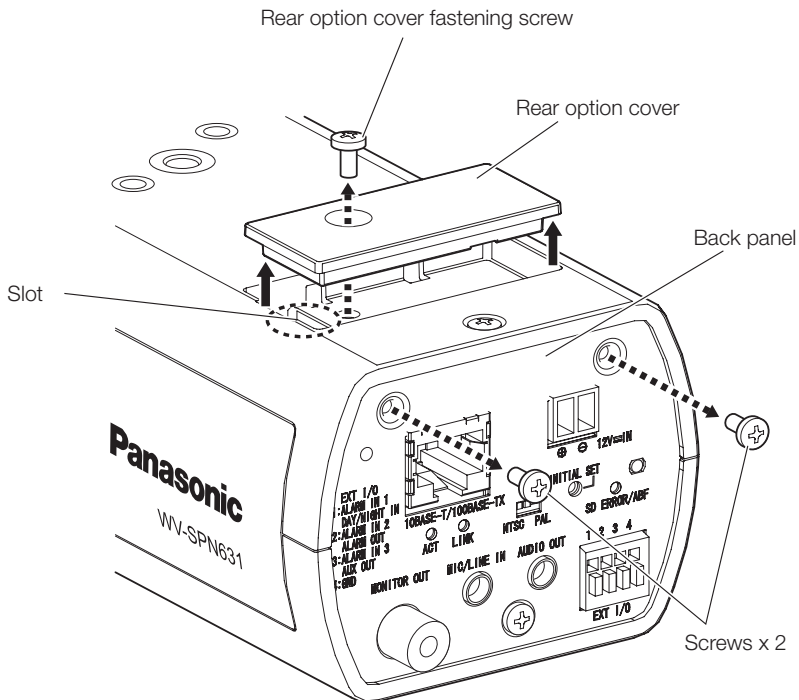

Step2

Connect the RS485 Output unit to the camera body and temporarily fasten it.

- 1 Connect the RS485 Output unit's connector (male) to the Rear option connector (female) of the camera body.

Note:

- Check that the connector is fully inserted.

- 2 After connecting the RS485 Output unit to the camera body as shown in the illustration below on the right, slide it towards the front. Insert the 2 protrusions of the RS485 Output unit into the 2 fastening holes of the camera body to temporarily fasten it.

1

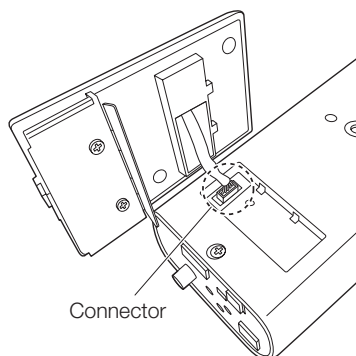

2

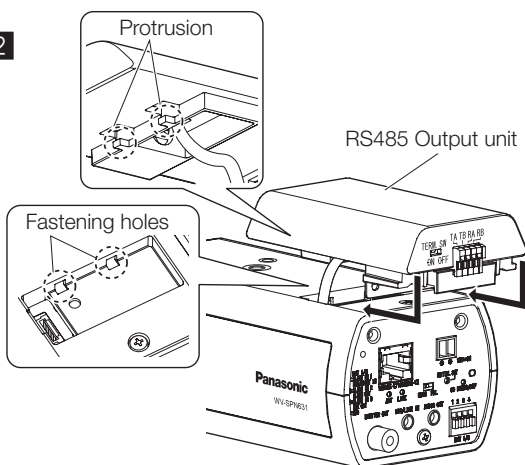

Step3

Fasten the RS485 Output unit.

- 1 Use screws A (accessory: M2.5 x 8 mm {5/16 inches}) to attach the RS485 Output unit to the rear side of the camera body. (Recommended tightening torque: 0.39 N·m {0.29 lbf·ft})

- 2 After mounting the RS485 Output unit, temporarily connect the cables to the camera body.

Refer to the Operating Instructions of the camera and the camera housing unit for more information on how to connect the cables and the wiring process.

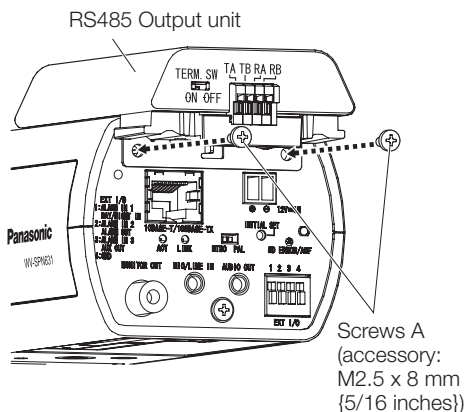

Step4

Connect the cables to the RS485 Output unit.

Connect a twisted-pair cable (locally procured) to the RS485 port.

When connecting an external device, remove 9 mm - 10 mm {11/32 inches - 13/32 inches} of the outer jacket of the cable and twist the cable core to prevent the short circuit first.

Specification of cable (wire): AWG22 - AWG28, Single core, twisted

* Check whether the stripped part of the wire is not exposed and is securely connected.

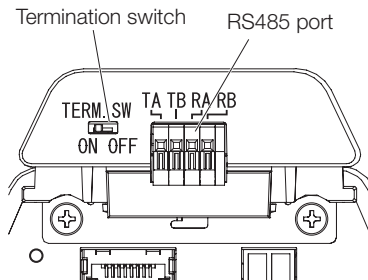

<When connecting the RS485 Output unit to a connection device one-to-one>

Turn the termination switch to [ON] when using the camera.

(The termination switch is set to [ON] at default settings.)

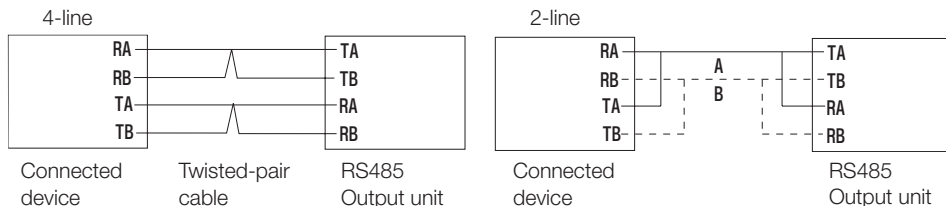

<When connecting the RS485 Output unit to the connection device with multiple daisy-chains connections>

When using the unit at the end of a daisy-chain connection

When the unit is connected in the middle of a daisy-chain connection

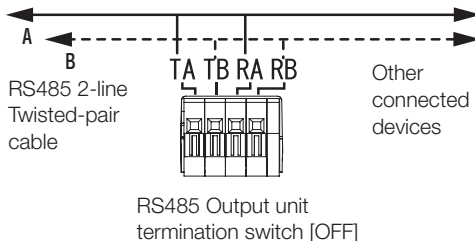
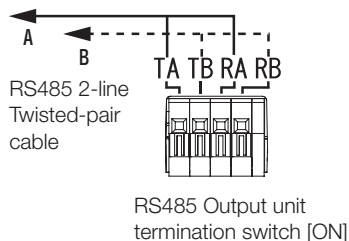

IMPORTANT:

- The RS485 port of this unit is intended for use with 4-line communications. When connecting 2-line communication devices, make connections as shown in the illustration above.
- When making connections with 2-line communications, select "2-line" in the setup menu. The configurations for the setup menu will be configured in Step5.
- Make connections so that excessive force is not applied to the twisted-pair cable when they are connected.
- If you plan on using a long twisted-pair cable stretched over a long distance, be sure to use a thick AWG22 - AWG24 cable.

Step5

After temporarily connecting the camera and PC to a network and installing the camera viewer software on the PC, perform the RS485 communication settings from the camera setup menu.

Connect the camera and PC to the same network by using a hub, or connect them directly by using a crossover cable. Temporarily connect all the systems, turn on the camera and implement the settings of the RS485.

1 Insert the provided CD-ROM with the camera into the CD-ROM drive of your PC.

- The License Agreement will be displayed. Read the Agreement and choose “I accept the term in the license agreement”, and click [OK].
- The launcher window will be displayed. If the launcher window is not displayed, double click the “CDLauncher.exe” file on the provided CD-ROM with the camera.

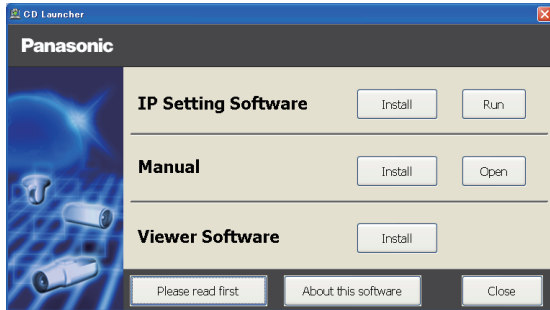

Note:

- Refer to “Using the CD-ROM” in the Operating Instructions on the provided CD-ROM with the camera for further information about CDLauncher.
 - For more information about the “System requirements for a PC” in order to connect with the camera, please refer to the “System requirements for a PC” in the Important Information.
-

2 Click the [Run] button next to [IP Setting Software].

[Panasonic IP Setting] screen will be displayed. After detecting the camera, the MAC Address/ IP address will be appeared.

- * The displayed camera information is not automatically updated. Click the [Search] button to update the information.

- 3 Select the camera you want to configure, and click [Access Camera].

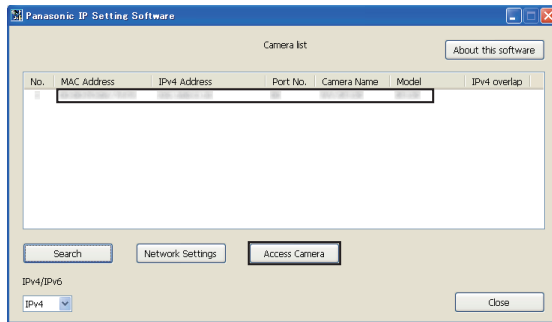

Note:

- When more than one unit is displayed in [Panasonic IP Setting Software] screen, click the unit with the same MAC address as the MAC address printed on the unit that you want to configure.
-

- 4 If the installation screen of the viewer software “Network Camera View 4S” is displayed, follow the instructions of the wizard to start the installation. (The viewer software is installed from the camera.)

- The “Live” page will be displayed.
- If you cannot install the viewer software “Network Camera View 4S” or if images are not displayed, click the [Install] button next to [Viewer Software] on the launcher window to install the software.
- When no image is displayed on the “Live” page, refer to the Operating Instructions on the provided CD-ROM with the camera.

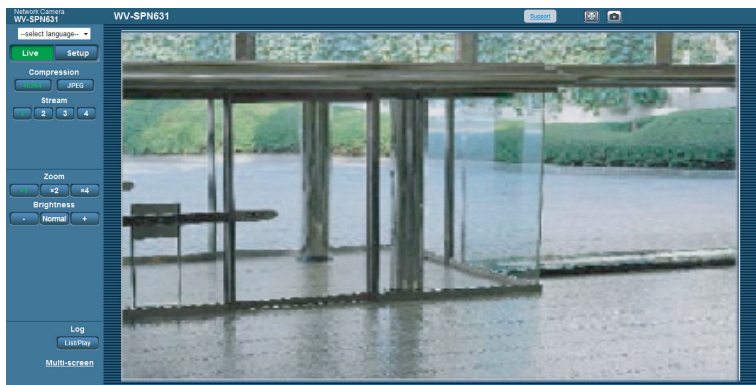

- Set your browser to compatibility view if no image is displayed. Refer to the Panasonic support website listed below for more information about configuration methods.
<http://security.panasonic.com/pss/security/support/info.html>

5 By clicking the [Setup] button on the "Live" page, the authentication dialog is displayed. Enter your user name and password, then click [OK]. The default settings are: user name [admin] and password [12345].

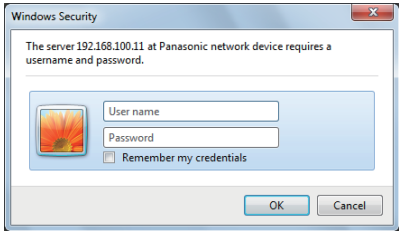

6 The basic setup screen of the camera is displayed, and the [Extension unit] button is displayed in the setup menu column on the left side of the screen.

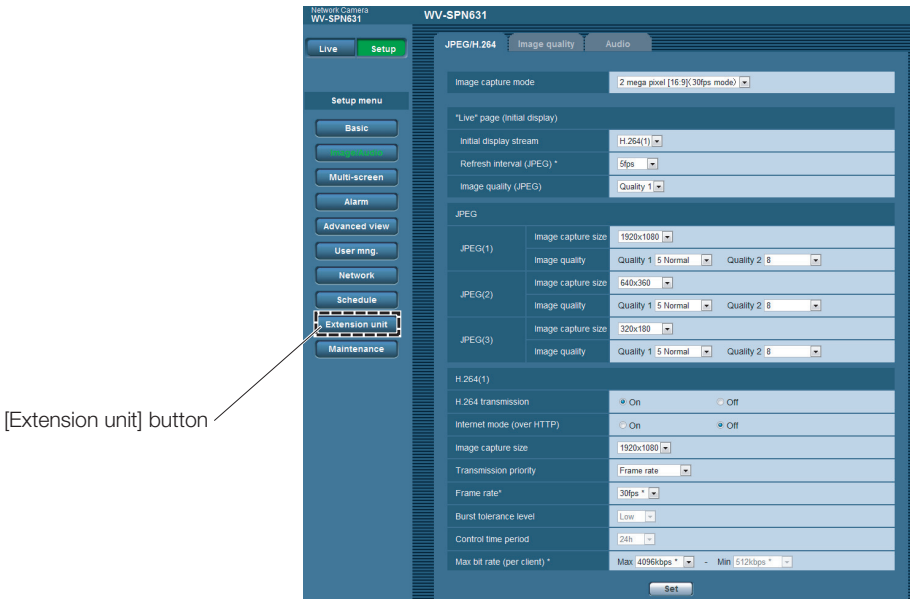

Step6

Configure the settings of the RS485 and perform an operational check.

1 Select the [Back unit] tab on the [Extension unit] page of the setup menu.

Setup items	Setup contents and defaults
Automatic detection	Control whether or not to auto detect the RS485 Output unit by selecting On/Off. Default: On
Additional function	Select an extension unit to use. This can only be done when "Automatic detection" is turned "Off".

- If "Automatic detection" is on, the RS485 Output unit is automatically detected when it is mounted and the camera is turned on.
 - * "Off" is displayed if the unit fails to correctly recognize the RS485 Output unit.
Check again that the connectors of the RS485 Output unit and the camera are properly connected and turn on the camera again.

2 Perform the steps listed below concerning RS485 communication and press the [Settings] button. (Refer to the configuration screen listed below and "RS485 Parameter List" on the next page, and perform configuration according to the settings of the camera and the RS485 communication device.)

3 Check that the connection device is operational by entering an RS485 command using a URL as shown in the example.

Input example: When inputting "http://192.168.0.10/" as the IP address of the camera and connecting to a pan/tilt head, input
"http://192.168.0.10/cgi-bin/directctrl?pan=8&rs485=on"
to check whether the PAN is operational.

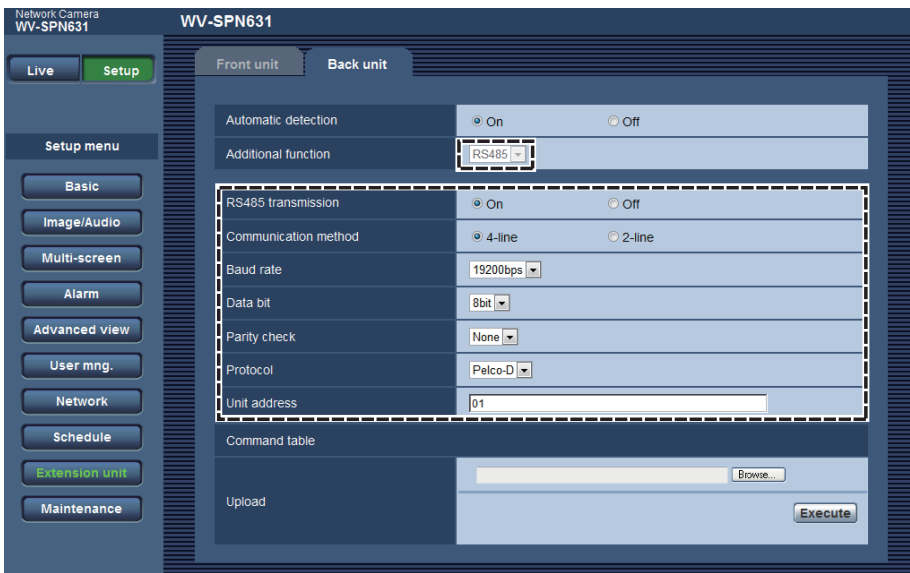

<RS485 Parameter List>

Setup items	Setup contents and defaults
RS485 transmission	Configure whether or not to control the connection devices through the camera using RS485 communication by selecting On/Off. Default: On
Communication method	The RS485's cable communication scheme can be configured to 4-line communications or 2-line communications. Default: 4-line
Baud rate	Select one of the following RS485 communication speeds. 2400 bps/ 4800 bps/ 9600 bps/ 19200 bps/ 38400 bps Default: 19200 bps
Data bit	Data bit can be set to 7 bit or 8 bit. Default: 8 bit
Parity check	Select one of the following options to configure whether or not to perform a parity check. None/ Odd/ Even Default: None
Protocol	Select a RS485 control command from one of the following controls. Pelco-D/ Pelco-P/ Custom Default: Pelco-D
Unit address	Allocate addresses for each connection device in order to send commands to a specific connection device linked over an RS485 line. Be careful that the address is not identical with another connection device's address. The setting range of the unit address varies depending on the protocol used. Usable characters include [0-9,a-z,A-Z]. Default: 01

Step7

Install the camera after mounting the cable cover.

- 1 Remove the screw (binding head screw: M2.5 x 5 mm {1/4 inches}) from the lower backside of the camera.

Note:

- Store the removed screw in a safe location for when you choose to remove the RS485 Output unit, as they will not be used from this point onwards.

- 2 Mount the camera to the ceiling or wall using the mount bracket, and connect the cables. For more information about the installation and connection methods of the camera, refer to the camera's Important Information or Installation Guide.
- 3 Fasten the cable cover to the rear side of the camera with the screws. (Recommended tightening torque: 0.39 N·m {0.29 lbf·ft})
 - Take care that no cables are caught in the cable cover.
- 4 Adjust the camera's direction, angle of view, and focus. For more information about adjustment methods, refer to the Operating Instructions of the lens or the Installation Guide of the camera.

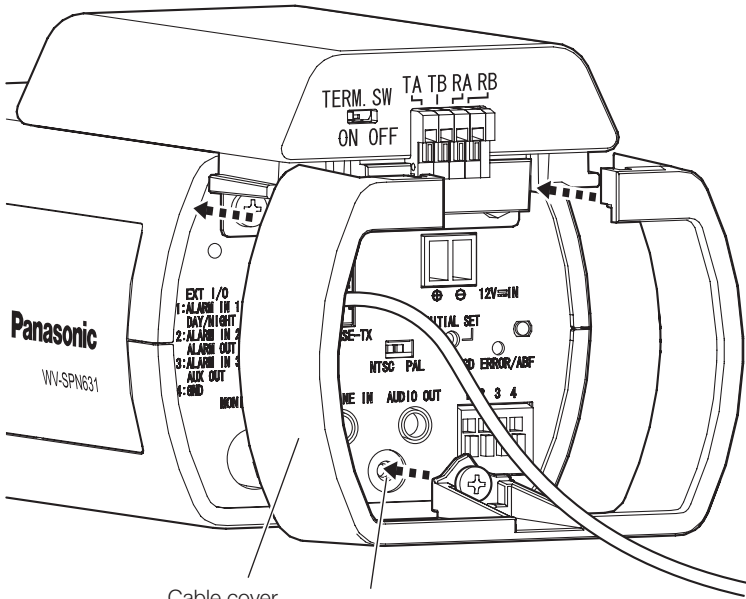

Cable cover

Screw hole on the lower backside of the camera

Specifications

Ambient operating temperature:	-10 °C to +50 °C {14 °F to 122 °F}
Ambient operating humidity:	10 % to 90 % (no condensation)
Serial port:	RS485 (For external device control)
Camera control protocol:	Pelco-D/ Pelco-P/ Custom
Dimensions:	71.0 mm (W) x 71.0 mm (H) x 89.2 mm (D) {2-13/16 inches (W) x 2-13/16 inches (H) x 3-1/2 inches (D)}
Mass:	Approx. 60 g {0.13 lbs}
Finish:	Unit (resin part): PC/ABS resin, sail white Unit (metal part): Steel, black chromate

IMPORTANT:

- When attaching this extension unit to a WV-SPN6 series camera, the outer dimensions will become bigger as shown in the illustration below.
When installing the camera in a camera housing, choose a camera housing that is sufficiently large.

■ Dimensions after installation of the RS485 Output unit

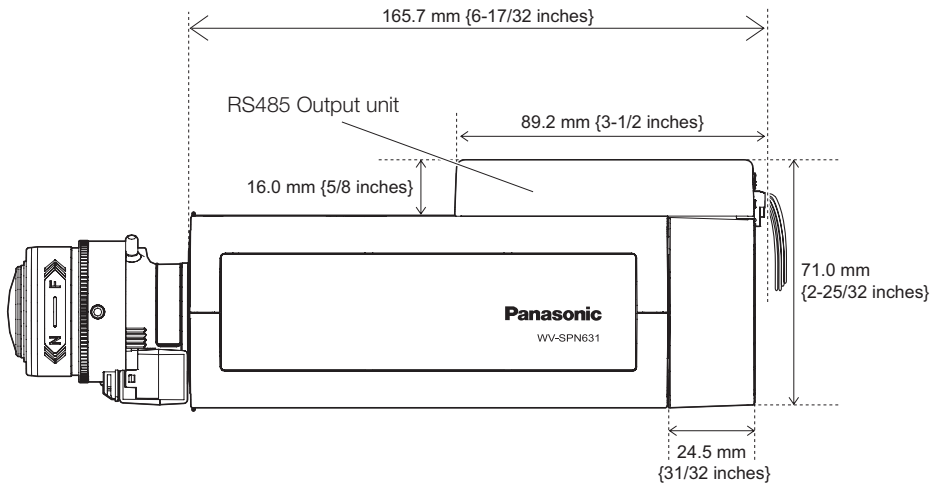

Standard accessories

Operating Instructions (this document).....	1 set
Screw A (M2.5 x 8 mm {5/16 inches}).....	3 pcs. (incl. 1 spare screw)
Cable cover	1 pc.
Warranty card	1 set

Information on Disposal for Users of Waste Electrical & Electronic Equipment (private households)



This symbol on the products and/or accompanying documents means that used electrical and electronic products should not be mixed with general household waste.

For proper treatment, recovery and recycling, please take these products to designated collection points, where they will be accepted on a free of charge basis.

Alternatively, in some countries you may be able to return your products to your local retailer upon the purchase of an equivalent new product.

Disposing of this product correctly will help to save valuable resources and prevent any potential negative effects on human health and the environment which could otherwise arise from inappropriate waste handling.

Please contact your local authority for further details of your nearest designated collection point.

Penalties may be applicable for incorrect disposal of this waste, in accordance with national legislation.

For business users in the European Union

If you wish to discard electrical and electronic equipment, please contact your dealer or supplier for further information.

Information on Disposal in other Countries outside the European Union

This symbol is only valid in the European Union.

If you wish to discard this product, please contact your local authorities or dealer and ask for the correct method of disposal.

For U.S. and Canada:

Panasonic System Communications Company of North America, Unit of Panasonic Corporation of North America

www.panasonic.com/business/
For customer support, call 1.800.528.6747
Two Riverfront Plaza, Newark, NJ 07102-5490

Panasonic Canada Inc.

5770 Ambler Drive, Mississauga,
Ontario, L4W 2T3 Canada
(905)624-5010
www.panasonic.ca

For Europe and other countries:

Panasonic Corporation

<http://www.panasonic.com>

Panasonic Corporation
Osaka, Japan

Authorised Representative in EU:

Panasonic Testing Centre
Panasonic Marketing Europe GmbH
Winsbergring 15, 22525 Hamburg, Germany

