

# Panasonic<sup>®</sup>

## Installation Guide

### Color CCTV Camera

# WV-CW594A

Model No.

Rain wash coating

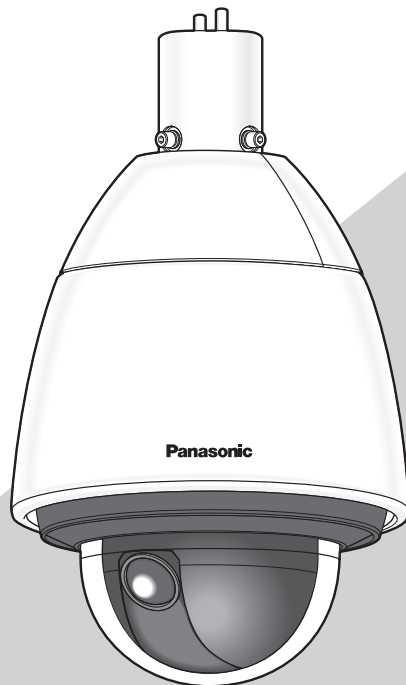

Before attempting to connect or operate this product,  
please read these instructions carefully and save this manual for future use.

The model number is abbreviated in some descriptions in this manual.

**WARNING:**

- All work related to the installation of this product should be made by qualified service personnel or system installers.
- The connections should comply with local electrical code.
- To prevent injury, this apparatus must be securely attached to the floor/wall/ceiling in accordance with the installation instructions.

UL listed model No.  
WV-CW594A

For Canada  
This Class A digital apparatus complies with Canadian ICES-003.



For U.S.A.

**NOTE:** This equipment has been tested and found to comply with the limits for a Class A digital device, pursuant to Part 15 of the FCC Rules. These limits are designed to provide reasonable protection against harmful interference when the equipment is operated in a commercial environment. This equipment generates, uses, and can radiate radio frequency energy and, if not installed and used in accordance with the instruction manual, may cause harmful interference to radio communications. Operation of this equipment in a residential area is likely to cause harmful interference in which case the user will be required to correct the interference at his own expense.

**FCC Caution:** To assure continued compliance, (example - use only shielded interface cables when connecting to computer or peripheral devices). Any changes or modifications not expressly approved by the party responsible for compliance could void the user's authority to operate this equipment.

For U.S.A.

The model number and serial number of this product may be found on the surface of the unit. You should note the model number and serial number of this unit in the space provided and retain this book as a permanent record of your purchase to aid identification in the event of theft.  
Model No. \_\_\_\_\_  
Serial No. \_\_\_\_\_

	<b>CAUTION</b> RISK OF ELECTRIC SHOCK DO NOT OPEN	
<b>CAUTION: TO REDUCE THE RISK OF ELECTRIC SHOCK, DO NOT REMOVE COVER (OR BACK). NO USER-SERVICEABLE PARTS INSIDE. REFER SERVICING TO QUALIFIED SERVICE PERSONNEL.</b>		

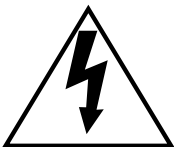

The lightning flash with arrowhead symbol, within an equilateral triangle, is intended to alert the user to the presence of uninsulated "dangerous voltage" within the product's enclosure that may be of sufficient magnitude to constitute a risk of electric shock to persons.



The exclamation point within an equilateral triangle is intended to alert the user to the presence of important operating and maintenance (servicing) instructions in the literature accompanying the appliance.

# Contents

Important safety instructions .....	4
Limitation of liability .....	5
Disclaimer of warranty .....	5
Preface .....	5
Features .....	6
About the user manuals .....	6
Trademarks and registered trademarks .....	7
Precautions .....	7
Major operating controls .....	9
Precautions for installation .....	10
DIP switch settings .....	12
■ Communication Parameters (DIP Switch 2) .....	12
■ Unit Number (DIP Switch 1) .....	13
■ RS485 Communication Parameters (DIP Switch 1) .....	15
Installation .....	16
■ Mounting the Camera .....	16
Connections .....	20
Troubleshooting .....	22
Specifications .....	26
Standard accessories .....	27

## Important safety instructions

- 1) Read these instructions.
- 2) Keep these instructions.
- 3) Heed all warnings.
- 4) Follow all instructions.
- 5) Do not block any ventilation openings. Install in accordance with the manufacturer's instructions.
- 6) Do not install near any heat sources such as radiators, heat registers, stoves, or other apparatus (including amplifiers) that produce heat.
- 7) Protect the power cord from being walked on or pinched particularly at plugs, convenience receptacles, and the point where they exit from the apparatus.
- 8) Only use attachments/accessories specified by the manufacturer.
- 9) Use only with the cart, stand, tripod, bracket, or table specified by the manufacturer, or sold with the apparatus. When a cart is used, use caution when moving the cart/apparatus combination to avoid injury from tip-over.



- 10) Refer all servicing to qualified service personnel. Servicing is required when the apparatus has been damaged in any way, such as power-supply cord or plug is damaged, liquid has been spilled or objects have fallen into the apparatus, the apparatus has been exposed to rain or moisture, does not operate normally, or has been dropped.

## Limitation of liability

THIS PUBLICATION IS PROVIDED "AS IS" WITHOUT WARRANTY OF ANY KIND, EITHER EXPRESS OR IMPLIED, INCLUDING BUT NOT LIMITED TO, THE IMPLIED WARRANTIES OF MERCHANTABILITY, FITNESS FOR ANY PARTICULAR PURPOSE, OR NON-INFRINGEMENT OF THE THIRD PARTY'S RIGHT.

THIS PUBLICATION COULD INCLUDE TECHNICAL INACCURACIES OR TYPOGRAPHICAL ERRORS. CHANGES ARE ADDED TO THE INFORMATION HEREIN, AT ANY TIME, FOR THE IMPROVEMENTS OF THIS PUBLICATION AND/OR THE CORRESPONDING PRODUCT (S).

## Disclaimer of warranty

IN NO EVENT SHALL Panasonic i-PRO Sensing Solutions Co., Ltd. BE LIABLE TO ANY PARTY OR ANY PERSON, EXCEPT FOR REPLACEMENT OR REASONABLE MAINTENANCE OF THE PRODUCT, FOR THE CASES, INCLUDING BUT NOT LIMITED TO BELOW:

- (1) ANY DAMAGE AND LOSS, INCLUDING WITHOUT LIMITATION, DIRECT OR INDIRECT, SPECIAL, CONSEQUENTIAL OR EXEMPLARY, ARISING OUT OF OR RELATING TO THE PRODUCT;
- (2) PERSONAL INJURY OR ANY DAMAGE CAUSED BY INAPPROPRIATE USE OR NEGLIGENT OPERATION OF THE USER;
- (3) UNAUTHORIZED DISASSEMBLE, REPAIR OR MODIFICATION OF THE PRODUCT BY THE USER;
- (4) INCONVENIENCE OR ANY LOSS ARISING WHEN IMAGES ARE NOT DISPLAYED, DUE TO ANY REASON OR CAUSE INCLUDING ANY FAILURE OR PROBLEM OF THE PRODUCT;
- (5) ANY PROBLEM, CONSEQUENTIAL INCONVENIENCE, OR LOSS OR DAMAGE, ARISING OUT OF THE SYSTEM COMBINED BY THE DEVICES OF THIRD PARTY;
- (6) ANY CLAIM OR ACTION FOR DAMAGES, BROUGHT BY ANY PERSON OR ORGANIZATION BEING A PHOTOGENIC SUBJECT, DUE TO VIOLATION OF PRIVACY WITH THE RESULT OF THAT SURVEILLANCE-CAMERA'S PICTURE, INCLUDING SAVED DATA, FOR SOME REASON, BECOMES PUBLIC OR IS USED FOR ANY PURPOSE;
- (7) LOSS OF REGISTERED DATA CAUSED BY ANY FAILURE.

## Preface

This color CCTV camera is a video surveillance device that incorporates a 1/4-type CCD, a 36x zoom lens, preset and pan and tilt capabilities in a dome configuration.

## Features

### Super Dynamic 6 (SUPER-D6)

SUPER-D6 can capture clear images of subjects whose illumination is extremely different.

### New DSP for high sensitivity

A new noise reduction system lowers minimum illumination to 0.5 lx in the color mode and 0.04 lx in the black-and-white mode.

### Auto night time switching to black-and-white mode

The camera can be configured to switch to the black-and-white mode automatically under low light conditions for clear images, even at night.

### Digital flip

Normally, a camera needs to stop when it points straight down during a tilt operation. With digital flip, however, the camera is able to tilt from 0° to 180° in a single motion. This makes it possible to track subjects passing directly under the camera more smoothly.

#### Digital Flip Operation

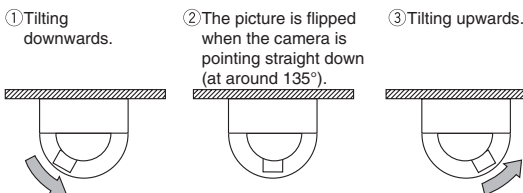

Digital flip is performed only when the system controller joystick is held downwards.

### Privacy zone function

The privacy zone function can mask specific areas of the scene from view.

### Patrol function

The patrol function can store manual camera move-

ment routines for automatic playback. For example, you can set the camera the movements of the people to be monitored, by replaying the stored parameters complicated movements are done automatically.

### Camera position memory

The system can be configured with up to 256 camera positions. A particular camera position can be selected and viewed by entering the applicable preset number on the system controller 10-key pad.

### Motion detection

The system can be configured so any motion on the monitor screen during surveillance causes output of an alarm signal.

### Internal heating fan

Prevents snow and frost from building up on the dome cover.\*1

### Dome cover with rain wash coating

The rain wash coating is a special coating applied to the surface of the dome cover that makes it hard for water droplets to adhere to the dome cover.\*2

### Waterproofing specifications

Outdoor enclosure based on IP66\*3 of IEC60529 standard.

\*1 Does not operate in environments with ambient temperatures under -50 °C {-58 °F}. In environments over -50 °C {-58 °F} defrosting may not function if wind and snow are too strong. Use it with the power on continuously to keep the temperature inside the camera over -10 °C {14 °F}.

\*2 The rain wash coating is only effective against water (rain water) and is not intended to be used to protect the surface of the dome cover from other substances such as oil.

\*3 Waterproof structure resistant to powerful jetting as classified by the International Protection code.

## About the user manuals

The operating instructions of the camera consist of 2 sets: this book and operating instructions (PDF). This book explains how to install the camera. Refer to the "Operating Instructions (PDF)" on the provided CD-ROM for descriptions of how to perform the

unit settings. Adobe® Reader® is required to read PDF. When the Adobe® Reader® is not installed on the PC, download the latest Adobe® Reader® from the Adobe web site and install it.

## Trademarks and registered trademarks

Adobe and Reader are either registered trademarks or trademarks of Adobe Systems Incorporated in the

United States and/or other countries.

## Precautions

**The following points as well as the contents of "Warning" and "Caution" shall be observed.**

### **Refer installation work to the dealer.**

Installation work requires technique and experiences. Otherwise injury, or damage to this product may result. Be sure to consult the dealer.

### **Do not insert any foreign objects.**

This could permanently damage this product. Turn the power off immediately and contact qualified service personnel for service.

### **Do not attempt to disassemble or modify this product.**

Failure to observe this may cause fire or electric shock. Consult the dealer for the repair or inspections.

### **Stop operation immediately when something is wrong with this product.**

When smoke goes up from this product or the smell of smoke comes from this product, continued use will result in fire, injury, or damage to the product. Turn the power off immediately and contact qualified service personnel for service.

### **Select an installation area that can support the total weight.**

Selecting an inappropriate installation surface may cause the product to fall down or topple over, resulting in injury. Installation work shall be started after sufficient reinforcement.

### **Periodic inspections shall be conducted.**

Rust on the metal parts or screws may cause the product to fall down resulting in injury or accidents. Consult the dealer for the inspections.

### **The measures of protection against a fall of this product shall be taken.**

Failure to observe this may cause a drop resulting in injury or accidents.

### **Do not touch the main body while this product is panning/tilting.**

Fingers may be caught up in the moving part, and that may result in injury.

### **Do not hang down from this product or use this product as a pedestal.**

Failure to observe this may cause injury or accidents.

### **Do not damage the power cable.**

Do not damage, fabricate, twist, stretch, bundle, or

forcibly bend the power cable. Do not place heavy objects. Keep away from heat sources.

Use of the damaged power cable may cause electric shock, short circuit, or fire.

Consult the dealer for repair.

### **Do not install this product on a place that is greatly influenced by wind.**

Installation on a place where the wind speed is 40 m/s or more per second may cause a fall of the product resulting in injury or accidents.

### **This product shall be installed in a vibration-free place.**

Failure to observe this may cause screws and bolts to be loosened and consequently to fall resulting in injury.

### **Install this product high enough to ensure that people don't hit their heads.**

Failure to observe this may cause a drop resulting in injury or accidents.

### **Do not strike or give a strong shock to this product.**

Failure to observe this may cause injury or fire.

### **Turn the power off when do wiring of this product.**

Failure to observe this may cause electric shock. In addition short circuit or wrong wiring may cause fire.

### **Do not use this product in an atmosphere of flammable gases.**

Failure to observe this may cause injury by explosion.

### **Avoid installing this product in locations where it is subject to damage by salt or corrosive gas.**

Otherwise the mounting fixtures will deteriorate, causing the product to fall down and leading to accidents.

### **Use the specified mount bracket.**

Failure to observe this may cause a drop resulting in injury or accidents.

### **Do not rub the edges of metal parts with your hand.**

Failure to observe this may cause injury.

### **Tighten screws and mounting fixtures to the specified torque.**

Failure to observe this may cause a drop resulting in injury or accidents.

### **[Precautions for use]**

### **This product has no power switch.**

When turning off the power, turn off a circuit breaker.

### To keep on using with stable performance

Parts of this product may deteriorate and it may shorten the lifetime of this product when using in locations subject to high temperatures and high humidity.

Do not expose this product to direct heat sources such as a heater.

### Handle this product with care.

Do not drop this product, nor apply shock or vibration to this product.

Failure to observe this may cause trouble.

### Do not touch the dome cover with your bare hands.

The rain wash coating is applied to the surface of the dome cover. Do not directly touch the surface of the dome cover or wipe it with a cloth or other product. Failure to observe this may reduce the effectiveness of the rain wash coating.

### Cleaning this product body

Be sure to turn off the power before cleaning.

- When cleaning the dome cover, wash away any dirt or other unwanted substances by pouring or spraying clean water from a hose or spray bottle. Do not wipe the dome cover with a cloth or other product. Do not use benzine, thinner, alcohol, or any other types of solvents or detergents.
- When cleaning areas other than the dome cover, do not use benzine, thinner, or any other types of solvents. Failure to observe this may cause discoloration. When using a chemical cloth for cleaning, read the caution provided with the chemical cloth product.

---

#### Important:

- The camera position may be moved inadvertently while cleaning the camera body. Restart the product or refresh the camera position (position refresh) to correct the camera position. Refer to the Operating Instructions (included in the CD-ROM) for further information.
- 

### What to do if "WARMING UP, PLEASE WAIT." appears on the display.

This message indicates that the temperature inside the camera has become extremely low.

In such a case, wait until the heater unit of the camera raises the internal temperature (for around 2 hours or more in low temperatures below -10 °C {14 °F}), and turn on the power again.

### What to do if "CAMERA TEMP. TOO COLD. POWER ON AT -30 DEG C (-22 DEG F) OR MORE." appears on the display.

The ambient temperature is too cold.

Please turn on the power under the conditions where the ambient temperature is above -30 °C {-22 °F}.

### Discoloration on the CCD color filter

When continuously shooting a bright light source such as a spotlight, the color filter of the CCD may

have deteriorated and it may cause discoloration. Even when changing the fixed shooting direction after continuously shooting a spotlight for a certain period, the discoloration may remain.

### Do not aim this product at strong light sources.

A light source such as a spot light causes a blooming (light bleeding) or a smear (vertical lines).

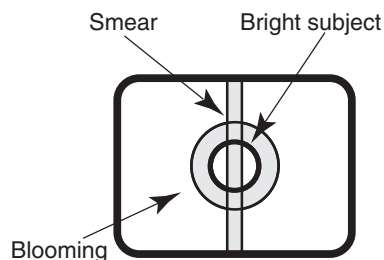

### About the self-diagnosis function

When this product malfunctions due to exogenous noise, etc. for 30 seconds or more, the product will automatically reset and will return to normal state. When the product is reset, initialization will be carried out as when the power of the product is turned on. When the product repeatedly resets, exogenous noise level around the product may be high and that may cause malfunction. Contact your dealer for instructions.

### Lens and pan/tilt head

If a lens and pan/tilt head are not performed for a long period of time, the grease coating inside these parts may become sticky. That may obstruct the parts from moving. To prevent this, move the lens or pan/tilt head periodically. Or perform position refresh periodically.

### About the position refresh function

Noise may be produced or the preset positions may become inaccurate after a long operation.

Execute the "REFRESH" operation periodically, the camera position will be corrected, and it is also recommended to clean the slip ring of the camera. Refer to the operating instructions (PDF) for further information.

### Consumable parts

The following are consumables: Replace them in accordance with their lives. Their lives vary depending on use environment and conditions.

Lens unit, slip ring: Approx. 3.7 million operations (Lifetime around 20000 hours is just an indication when using the camera at +35 °C {95 °F}.)

Cooling fan (motor): around 52000 hours

### Indication label

Refer to the indication label on the back of sunshield for the information on equipment classification and power source, etc.



## Major operating controls

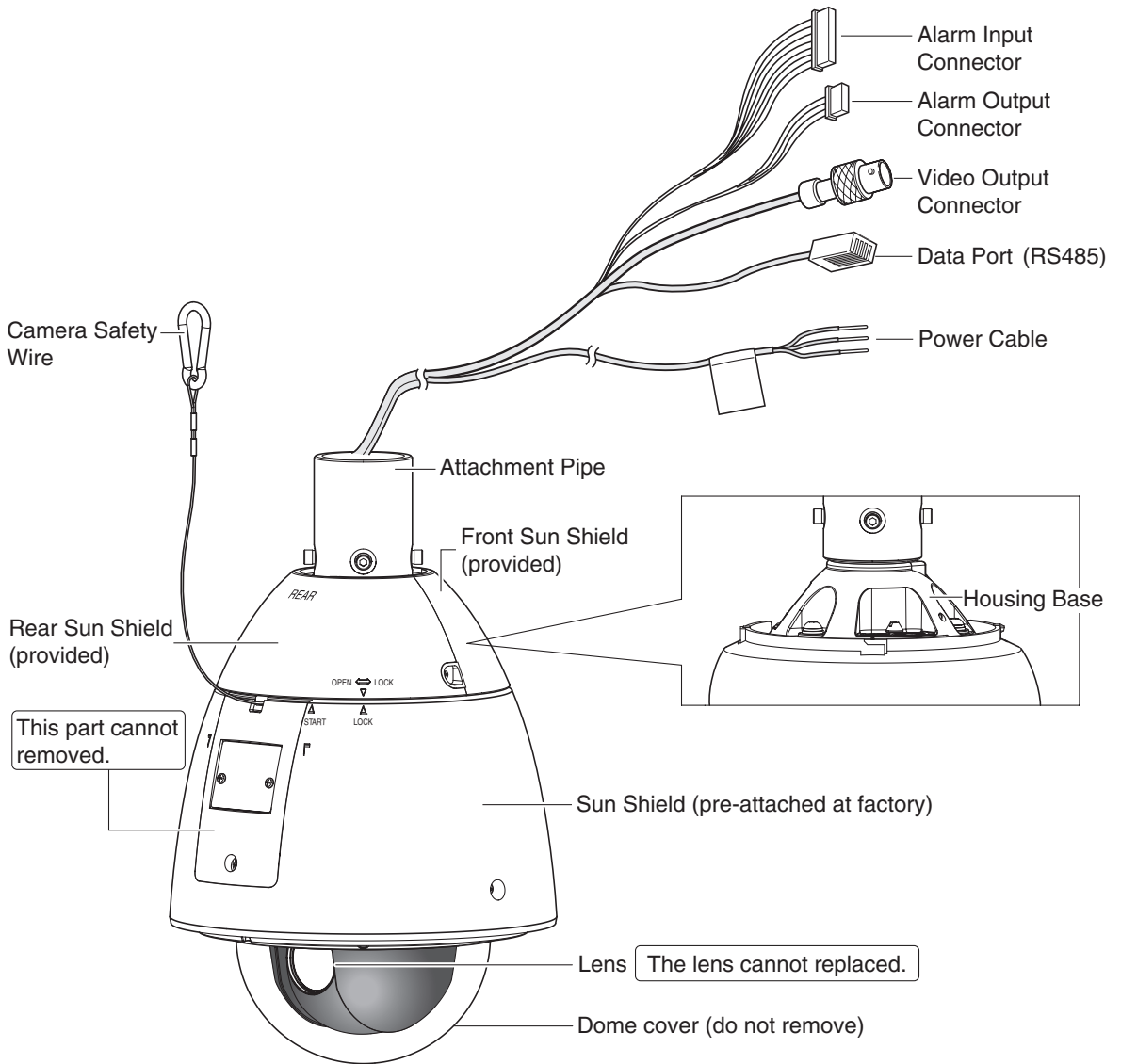

### Ensuring Trouble-free Operation

- This camera uses a "slip ring" for transmission of electrical power and signals. A dirty slip ring can cause deterioration of picture quality during panning and generation of noise. In order to ensure trouble-free camera operation, make sure that the cleaning function is turned on. Refer to the operating instructions (PDF).
- If cleaning the slip ring does not eliminate poor picture quality and noise, it could mean that the slip ring has reached the end of its service life. Contact a qualified service person or system installer to have it replaced.

## Precautions for installation

The following points as well as the contents of "Warning" and "Caution" shall be observed.

**Panasonic assumes no responsibility for injuries or property damage resulting from failures arising out of improper installation or operation inconsistent with this documentation.**

**Installation work shall be performed in accordance with the technology standard of the electric installation.**

### Note:

- Select a place that is strong enough for the installation. If you install the camera on a ceiling or wall, except for accidents caused by fault in the camera, Panasonic holds absolutely no responsibility for accidents caused by the camera falling due to unsuitable installation. Take sufficient care when installing the camera. If the installation is not strong enough, be sure to sufficiently reinforce the location and check that it is safe.
- To prevent the camera from falling, attach the safety wire to the mounting bracket or the anchor bolt before starting to install the camera to prevent it from falling.
- Always request installation work from a qualified service person or system installer. Lack of technical knowledge creates the risk of fire, electric shock, personal injury, and material damage.

### Installation Location

- Install the camera on a concrete ceiling or wall at a location that is sufficiently strong to support it.
- Bolts for mounting the ceiling mount Attachment Pipe to a ceiling or wall are not provided. You need to purchase them separately in accordance with the materials and strength of the place you are installing the camera.

**This camera is designed for use in a hanging configuration only.**

**Install the camera in a horizontal configuration, with the dome pointed downwards.**

- Ensure that the mounting surface, anchor and screws are sufficiently strong.
- Do not mount this product on a plaster board or a wooden section because they are too weak. If this product is unavoidably mounted on such a section, the section shall be sufficiently reinforced.

**Avoid installing this product in the following locations.**

- Locations where a chemical agent is used such as a swimming pool.
- Locations subject to steam and oil smoke such as a kitchen, Locations near flammable gas or vapor.
- Locations where radiation or x-ray emissions are produced.
- Locations where corrosive gas is produced, Locations where it may be damaged by briny air such as seashores.
- Locations where the temperature is not within  $-50\text{ }^{\circ}\text{C}$  to  $+50\text{ }^{\circ}\text{C}$   $\{-58\text{ }^{\circ}\text{F}$  to  $+122\text{ }^{\circ}\text{F}\}$ .
- Locations subject to vibrations (This product is not designed for on-vehicle use.)
- Locations subject to condensation as the result of severe changes in temperature (In case of installing the product in such locations, the dome cover may become foggy or condensation may be caused on the cover.)

**Avoid moist or dusty places to install this product.**

Otherwise, lifetime of the internal parts may be shortened.

**Avoid installing this product in a place with a high level of noise.**

Installation near an air conditioner, an air cleaner, a vending machine, or the like causes noise.

**Remove the Protection Cover from the dome cover after the installation is complete.**

**Be sure to remove this product if it is not in use.**

**Keep this product cable away from the lighting cable.**

Conduct the power distribution work to keep a distance of 1 m or more from the 120V AC power line. Or conduct the electric conduit work separately.

Failure to observe this may cause noise.

**Radio interference**

When this product is used near TV/radio antenna, strong electric field or magnetic field (near a motor or a transformer), images may be distorted and noise sound may be produced. In such a case, run the camera cable through specialized steel conduit tubes.

### **Take notice of humidity.**

Install this product when the humidity is low. If this product is installed during rainfall or at a high humidity, the inside may be exposed to moisture and the dome cover may become foggy.

### **Locally procure the screws**

Screws are not supplied with this product. Prepare the screws according to the material, structure, strength and other factors of the mounting area and the total weight of objects to be mounted.

### **Screw tightening**

- The screws and bolts must be tightened with an appropriate tightening torque according to the material and strength of the installation area.
- Do not use an impact driver. Failure to observe this may cause overtightening and consequently damage to the screws.
- When a screw is tightened, make the screw at a right angle to the surface. After tightening the screws or bolts, perform visual check to ensure tightening is enough and there is no backlash.

### **Heater unit**

This product is equipped with an internal heater unit for use in cold climates. The heater unit turns on automatically when the temperature inside the product drops below +10 °C {50 °F}. However, in an extremely low-temperature environment below -30 °C {-22 °F}, snow and frost may not be defrosted from the dome cover. When using this product in cold climates, take notice of the ambient and internal temperatures of the product. When this product is installed and operated in low temperatures below -10 °C {14 °F}, normal images may not be obtained immediately after startup. In such a case, wait around 2 hours or more, and turn on the power again.

### **Influence on images and their quality**

This product has no wiper unit. Under the following conditions, image quality may deteriorate or images may not be viewed properly.

#### **(1) Influence by rainfall**

Due to the wind that accompanies rainfall, images may be less viewable.

#### **(2) Influence by snowfall**

Due to the wind that accompanies snowfall, snow may fall on the dome cover. That may partially make surveillance images inviewable. (The extent of inviewability may vary depending on the amount of snowfall and the quality of snow.)

#### **(3) Influence by dust in the air or gas emission from vehicles**

Depending on the installation environment, dome cover may be dirty due to dust in the air or gas emission from vehicles. That may degrade the quality of images.

### **Check before connection**

Compatibility of devices are restricted. Before connections, check the ratings and dimensions of the devices to be used.

Contact your dealer for details.

### **Important hints to help with the installation**

A self-cleaning function is activated (PAN/TILT/ ZOOM/ FOCUS) when the camera is turned on.

# DIP switch settings

## Important:

- Before setting up the camera for a configuration where the camera's data port (RS485) is used for camera control (pan, tilt, etc.) by the system controller, the camera's DIP switches must be configured to specify the unit number and communication parameters.

If DIP switch setting is not performed, the system controller control will not be possible and camera setup will have to be performed again. Be sure to check the DIP switch settings before setting up the camera.

1. Attaching and removing the housing base  
For removing the Housing Base, refer to pages 16 to 19.

2. Set the DIP switches as the following:  
Communication parameters: Set with switch 2  
Unit number: Set with switch 1

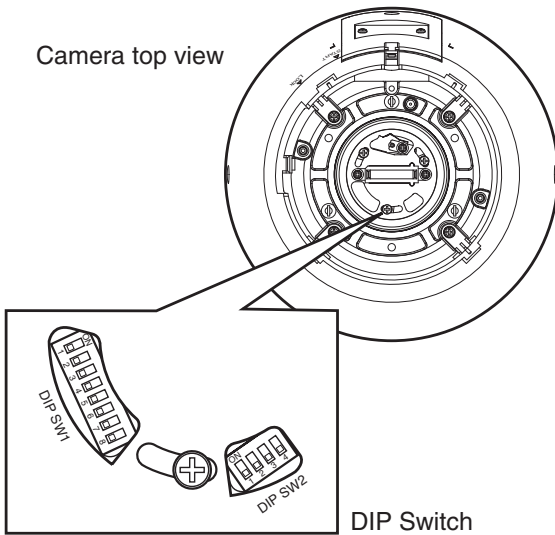

## ■ Communication Parameters (DIP Switch 2)

The factory default settings are all OFF.

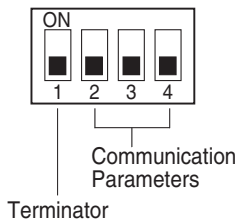

### Switch 1: Terminator (Internal Termination Resistance)

Set to ON in the following situations.

- When 1 camera is connected to this unit
- When 2 or more cameras are connected to this unit that works as a termination

### Switches 2 to 4: Communication Parameters



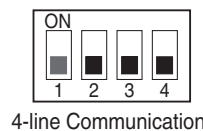







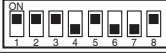
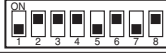
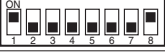
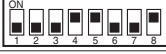

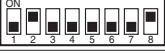
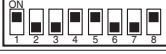
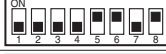
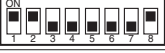
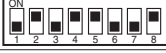
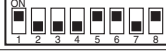









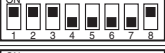
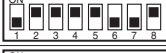
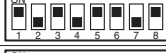

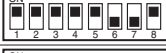
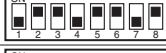
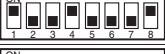
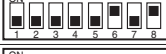
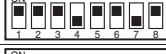
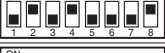

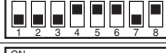

























This setting toggles between 2-line and 4-line communication. Use these switches to select the communication protocol being used.



## ■ Unit Number (DIP Switch 1)

The factory default settings of these DIP switches are all OFF. (Coaxial Multiplex System)

### Configuration for using Panasonic Protocol

DIP Switch 1	Unit Number	DIP Switch 1	Unit Number	DIP Switch 1	Unit Number
	1 ~ 96*		23		46
	1		24		47
	2		25		48
	3		26		49
	4		27		50
	5		28		51
	6		29		52
	7		30		53
	8		31		54
	9		32		55
	10		33		56
	11		34		57
	12		35		58
	13		36		59
	14		37		60
	15		38		61
	16		39		62
	17		40		63
	18		41		64
	19		42		65
	20		43		66
	21		44		67
	22		45		68

DIP Switch 1	Unit Number	DIP Switch 1	Unit Number	DIP Switch 1	Unit Number
	69		78		87
	70		79		88
	71		80		89
	72		81		90
	73		82		91
	74		83		92
	75		84		93
	76		85		94
	77		86		95

### Configuration for using Pelco protocol

DIP Switch 1	Unit Number Pelco-P	Unit Number Pelco-D	DIP Switch 1	Unit Number Pelco-P	Unit Number Pelco-D	DIP Switch 1	Unit Number Pelco-P	Unit Number Pelco-D
	1	32-254		12	11		23	22
	2	1		13	12		24	23
	3	2		14	13		25	24
	4	3		15	14		26	25
	5	4		16	15		27	26
	6	5		17	16		28	27
	7	6		18	17		29	28
	8	7		19	18		30	29
	9	8		20	19		31	30
	10	9		21	20		32	31
	11	10		22	21			

#### Important:





- When using Pelco protocol, make sure that the system works properly before use. Some functions using Pelco protocol may be restricted when this camera and the apparatuses (commercially available) compatible with Pelco protocol operate together.

#### Note:

- When using the Unit Number 1 to 96 of Panasonic Protocol and using the Unit Number 32 to 254 of Pelco-D protocol, the unit number setting needs to be configured using the RS485 SET UP menu. For details about configuring this setting, refer to the operating instructions (PDF).
- Turning on power when this setting is selected causes the RS485 SET UP menu to appear during the initialisation routine.

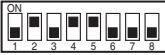
## ■ RS485 Communication Parameters (DIP Switch 1)

Configuring DIP Switch 1 as shown below resets communication parameters to their factory default settings. You can then change the settings as desired.

DIP Switch 1	Setting Description
	This setting resets communication parameters to the factory default settings.
	BAUD RATE : 19 200 bit/s, DATA BIT : 8 bit, PARITY CHECK : NONE, STOP BIT : 1 bit
	BAUD RATE : 9 600 bit/s, DATA BIT : 8 bit, PARITY CHECK : NONE, STOP BIT : 1 bit
	BAUD RATE : 4 800 bit/s, DATA BIT : 8 bit, PARITY CHECK : NONE, STOP BIT : 1 bit
	BAUD RATE : 2 400 bit/s, DATA BIT : 8 bit, PARITY CHECK : NONE, STOP BIT : 1 bit

Perform the following steps to use this setting.

- (1) Turn off the camera and use DIP Switch 1 to configure RS485 communication parameters as shown above.
- (2) Turn on the camera.  
This applies the setting you configured in step (1).
- (3) Turn off the camera, use DIP Switch 1 to set the unit number (see pages 13 and 14), and then turn the camera back on again.

# Installation

## Precautions

- Make sure that the place you are installing the camera is strong enough to support it. If it is not strong enough, then the camera may fall and hurt someone.
- The following steps of installation and connection work should be done by qualified service personnel or system installers and should conform to all local codes.
- Be sure to turn the power off before installation and connection.
- Do not install the camera near the air outlet of an air conditioner.

## ■ Mounting the Camera

### Ceiling mount

The figure shows an example of the camera mounted on a ceiling with a locally procured bracket. Refer to the instructions included with the bracket for filling gaps and holes with waterproof material.

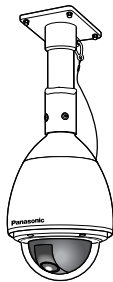

## ■ Construction

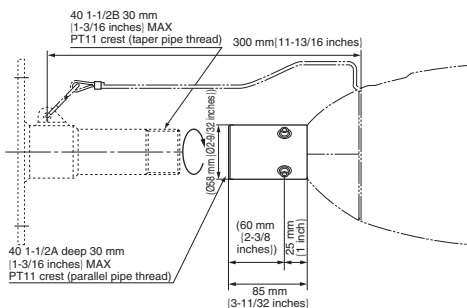

### STEP 1

Attach the camera to the housing base, and secure the camera and the housing base with the mounting screws (x3).

The screws that are removed need to be used during reassembly. Be careful to not lose them.

\* Special screw (mounting screw)

Use a hexagon wrench for the hexagon screw (M5).

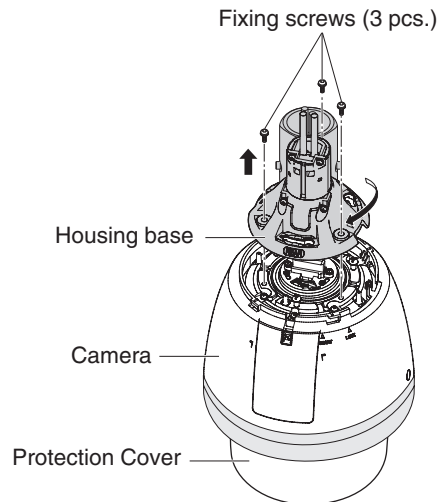

### Note:

- When removing the front and rear sun shields, perform steps 5 to 7 in the reverse order.

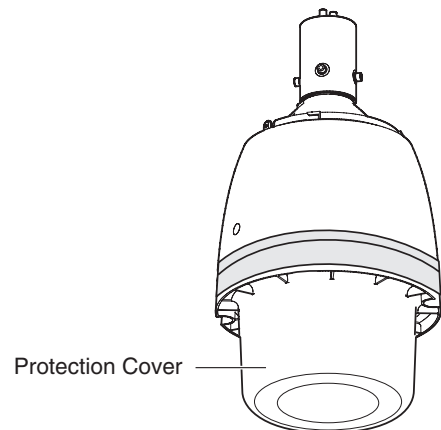

### Important:

- Remove the Protection Cover from the dome cover after the installation is complete.



## STEP 2

To separate the housing base from the camera, turn the housing base to the direction of the arrow as illustrated. (Refer to the illustration in Step 1).

## STEP 3

Remove the attachment pipe from the housing base by loosening 4 screws.

\* Special screw (mounting screw): Use a hexagon wrench for the hexagon screw (M6).

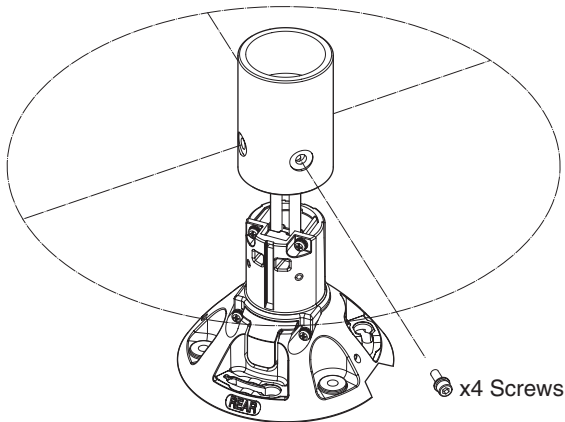

## STEP 4

(1) Fix the bracket to the installation surface using appropriate bolts, nuts or the like (not supplied).

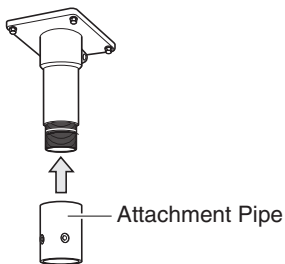

(2) Fix the attachment pipe to the bracket.

## STEP 5

Thread cables through the bracket. Connect the cables to the camera (→ page 20).

### Warning:

- Seal the cables with plastic or rubber tape to prevent it from being exposed.

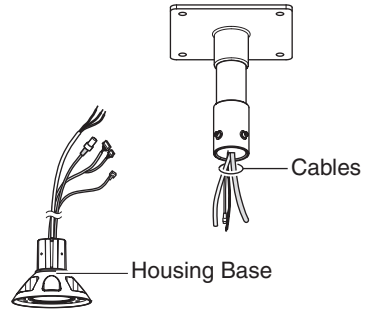

## STEP 6

Fix the housing base to the attachment pipe.

- Fasten 4 screws (the screws that were removed in step 3) making sure that "REAR" engraved on the housing base faces the wall.  
(Recommended tightening torque: 2.45 N·m (1.81 lbf·ft))
- Fill the gap between the bracket and attachment pipe with waterproof material such as silicon clay. See instructions of the bracket for details.

### Important:

- Carefully apply the sealing so that water or moisture cannot get inside. If water gets inside the camera it could cause a shock or fire. Also, if moisture gets inside the camera it could cause the dome to become foggy.

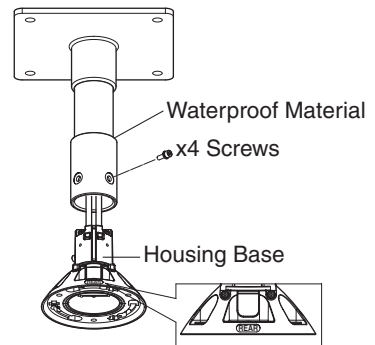

## STEP 7

(1) Check that the projection of the leaf spring on the top of the camera is at the "START" position. If the projection is not at the "START" position, turn the plate clockwise to match it to the "START" position.

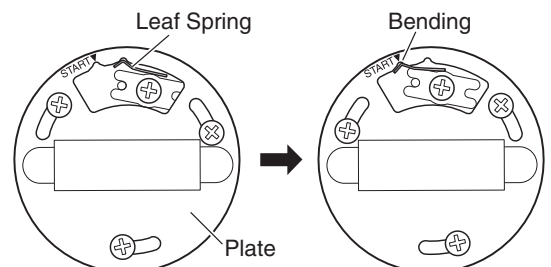

(2) Be sure to hook the camera safety wire into the bracket.

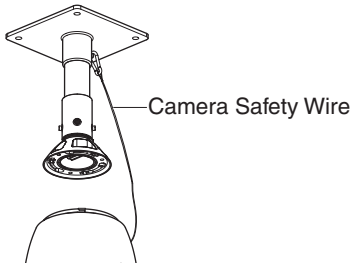

**Important:**

- Give sufficient length to the safety wire when installing.
- Fix the safety wire to a strong place, considering the weight of the camera (4.5 kg {9.92 lbs}).

(3) Install the camera to the housing mounting base. Install the camera to the housing mounting base so that the guide pin at the camera top will be directed toward "REAR" engraved on the housing mounting base. Turn the camera counter-clockwise, viewed from the bottom, to confirm that the camera is fixed. Securely tighten the screws\* that were removed when the housing mounting base was removed. (Recommended tightening torque: 2.45 N·m {1.81 lbf-ft})

\* Special screw (mounting screw)

Use a hexagon wrench for the hexagon screw (M5).

View from the top

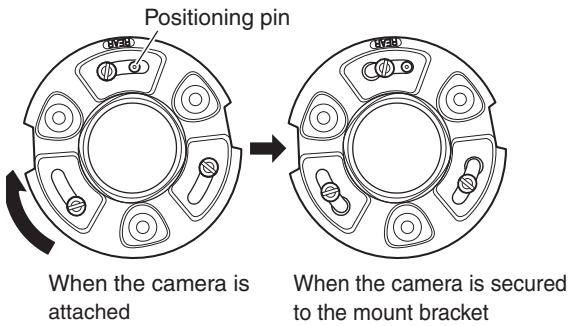

Fixing screws (3 pcs.)

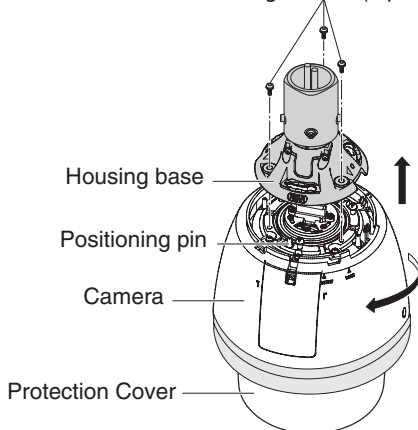

Poorly tightened screws may result in water leaking into the camera or possible fire.

**STEP 8**

Attach the front and rear sunshields (accessory) to the camera.

- (1) Put the fingers on the dents of the front and rear sunshields to detach the hooks on both sides. The sun-shield will be divided into two parts. For loss prevention, one side of the front and rear sunshields are linked together with a wire.

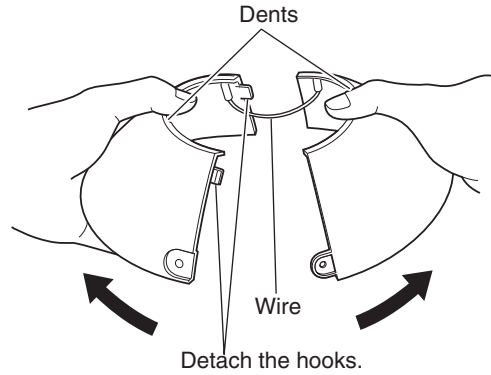

- (2) Locate the front and rear sunshields to the position that covers the housing base.

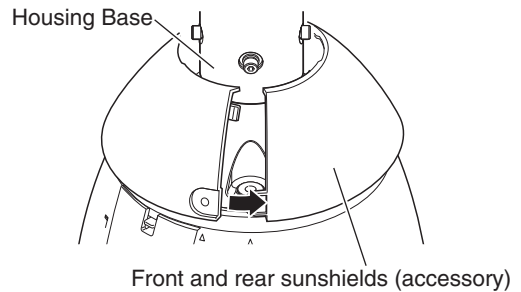

- (3) Joint both sides of front and rear sunshields. Joint the hook and dents on the linked side, and then joint the other side.

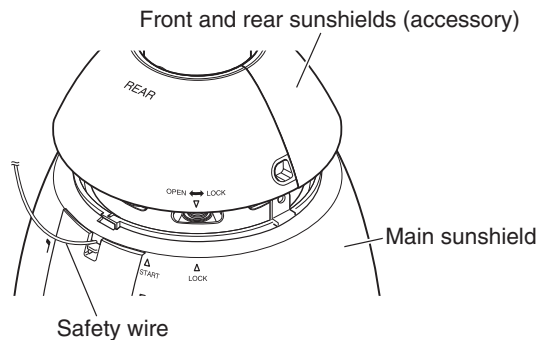

---

**Important:**

- Joint both sides of the front and rear sunshields before fitting in the main sunshield.
  - Do not trap the safety wire inside.
  - The safety wire is designed to support only the weight of the camera when the camera falls. Do not put an excessive weight that the safety wire cannot support.
- 

**STEP 9**

Fit the front and rear sunshields in the main sunshield.

- Align "▽" of the rear sunshield to "△ START" of the main sunshield. Then, turn the front and rear sunshields toward "LOCK" until a click is heard.

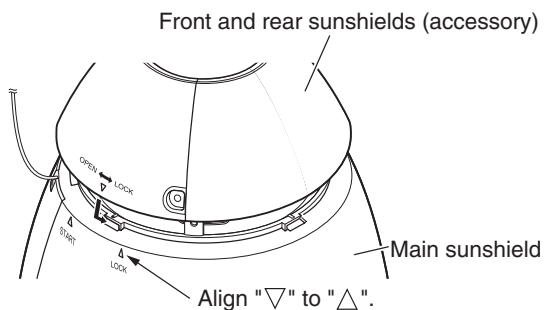
**STEP 10**

Fix the front and rear sunshields on the camera using the front/rear sunshield fixing screw (accessory). (Recommended tightening torque: 0.72 N·m {0.53 lbf·ft})

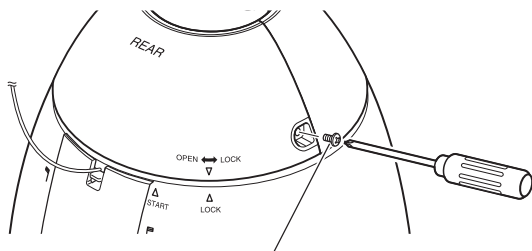

Front and rear sunshields fixing screw (accessory)

---

**Important:**

- When the power of the camera is turned on, the camera will start panning and the position will automatically be initialized.
- 

**Note:**

- When removing the front and rear sunshields, perform steps 8 to 10 in the reverse order.
- 

**STEP 11**

After the installation is completed, remove the tape wrapped around the camera while holding the Protection Cover, and then take off the Protection Cover.

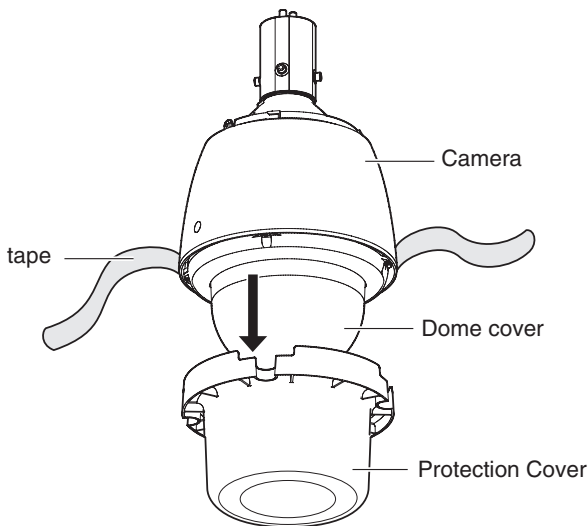

# Connections

## Cautions:

- FOR UL LISTED MODEL(S), ONLY CONNECT THIS TO 24 V AC CLASS 2 POWER SUPPLY.
- Be sure to connect the grounding lead to the GND terminal.

## Precautions

- The following connections should be made by qualified service personnel or system installers in accordance with all local codes.
- Turn off the power at the fuse box before starting the installation work, or it so could result in fire, electric shock, personal injury, and material damage.

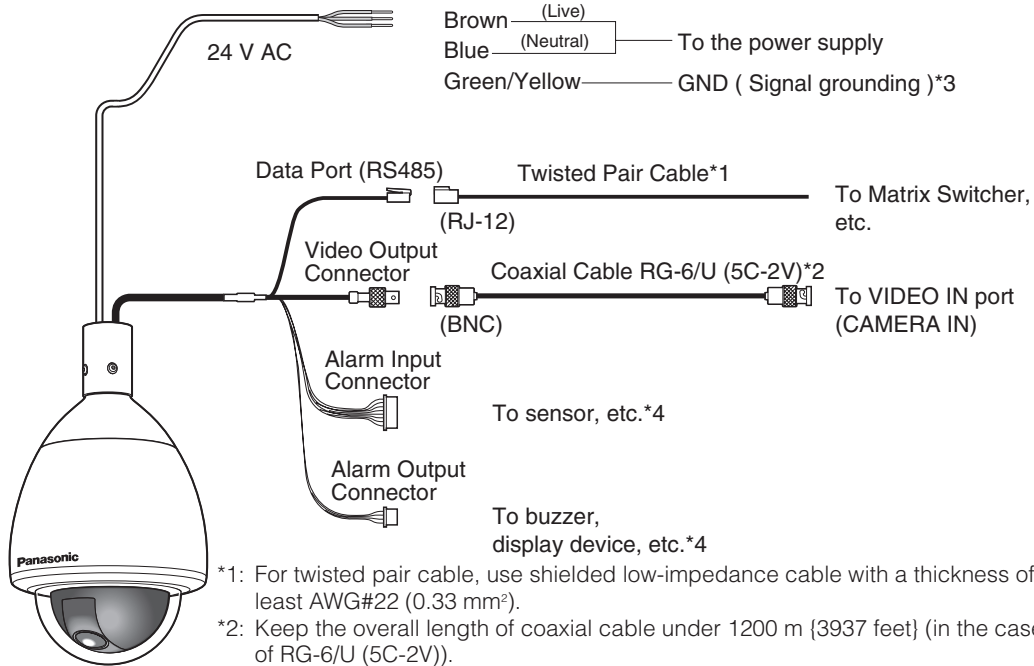

\*1: For twisted pair cable, use shielded low-impedance cable with a thickness of at least AWG#22 (0.33 mm<sup>2</sup>).

\*2: Keep the overall length of coaxial cable under 1200 m {3937 feet} (in the case of RG-6/U (5C-2V)).

\*3: Be sure to connect the grounding lead to the GND terminal.

\*4: Since a female cable is not attached, cut off the connector and connect to the twisted pair cable of the same type.

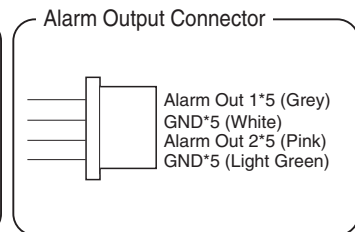
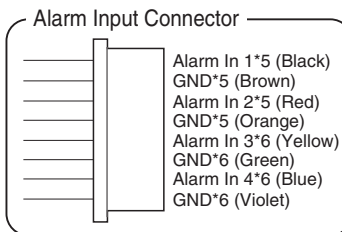
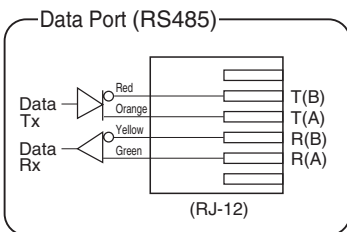

\*5: The type of twisted pair cable is AWG#28.

\*6: The type of twisted pair cable is AWG#26.

### Alarm In/Out Ratings

**Alarm In** : 5 V DC pull-up input. Drive capacity of at least 0.2 mA required.

**OFF** : 4 V to 5 V DC, or open

**ON** : 1 V DC or less, or short

**Alarm Out** : Open collector output. 16 V DC, maximum drive current: 100 mA

**OFF** : Open

**ON** : 100 mA or less

---

#### Note:

- Do not turn off camera power within 30 seconds after turning it on. Doing so can cause pan, tilt, zoom, or focus to go out of position.
- 

### • 24 V AC Power Supply Connection

Recommended wire gauge sizes for 24 V AC line

Copper wire size (AWG)	#24 (0.22 mm <sup>2</sup> )	#22 (0.33 mm <sup>2</sup> )	#20 (0.52 mm <sup>2</sup> )	#18 (0.83 mm <sup>2</sup> )	
Length of cable (approx.)	(m)	20	30	45	75
	(feet)	65	100	150	250

---

#### Important:

- The power supply of 24 V AC shall be insulated against 120 V AC power.
- 

---

#### Note:

- Can only be connected to 24 V AC power supply.
  - When using an alarm input or output connector, please connect directly (there is no dedicated cable in between).
-

# Troubleshooting

Before requesting service, check the following symptoms to see if you can solve the problem yourself. If the countermeasures described below do not correct the problem, or if the symptoms you are experiencing are not covered here, contact a quality service person or system installer.

Problem	Cause and Recommended Action	Reference Pages
<b>No picture (dark screen)</b>	<ul style="list-style-type: none"> <li>Is the camera connected correctly? Check the operating instructions that come with your system controller.</li> </ul>	<p>—</p>
	<ul style="list-style-type: none"> <li>Is the lens iris closed? Execute the iris reset from the system controller you are using.</li> </ul>	<p><b>Operating Instructions</b></p>
	<ul style="list-style-type: none"> <li>Is the camera set up for a fixed shutter speed?</li> </ul>	<p><b>Operating Instructions</b></p>
<b>White picture</b>	<ul style="list-style-type: none"> <li>Is the lens iris open?</li> </ul>	<p><b>Operating Instructions</b></p>
	<ul style="list-style-type: none"> <li>Is FIX selected for the electronic sensitivity enhancement (SENS UP) setting?</li> </ul>	<p><b>Operating Instructions</b></p>
<b>Out of focus picture</b>	<ul style="list-style-type: none"> <li>Is the dome cover or lens of the camera dirty? If so, clean them.</li> </ul>	<p><b>7</b></p>
	<ul style="list-style-type: none"> <li>Is MANUAL selected for the auto focus mode?</li> </ul>	<p><b>Operating Instructions</b></p>
	<ul style="list-style-type: none"> <li>Is the object one that is not compatible with auto focus? For such objects, focus manually.</li> </ul>	<p><b>Operating Instructions</b></p>
<b>Digital noise in the picture</b>	<ul style="list-style-type: none"> <li>The slip ring may be dirty. Do you have the cleaning function turned on?</li> </ul>	<p><b>Operating Instructions</b></p>
	<ul style="list-style-type: none"> <li>Is the camera set up correctly?</li> </ul>	<p><b>10</b></p>

Problem	Cause and Recommended Action	Reference Pages
<b>Poor picture color</b>	<ul style="list-style-type: none"> <li>• Check the white balance setting.</li> </ul>	<b>Operating Instructions</b>
	<ul style="list-style-type: none"> <li>• Use the special setup menu to adjust picture quality.</li> </ul>	<b>Operating Instructions</b>
	<ul style="list-style-type: none"> <li>• Is the dome cover or lens of the camera dirty? If so, clean them.</li> </ul>	<b>7</b>
<b>Image flicker</b>	<ul style="list-style-type: none"> <li>• If Super Dynamic 6 is turned on, turn it off.</li> </ul>	<b>Operating Instructions</b>
<b>Afterimages in the picture</b>	<ul style="list-style-type: none"> <li>• Check the DNR setting.</li> </ul>	<b>Operating Instructions</b>
<b>Black-and-white picture</b>	<ul style="list-style-type: none"> <li>• The camera has an auto black-and-white switching mode function. Check the setting of this mode.</li> </ul>	<b>Operating Instructions</b>
<b>Frequent switching between the color and the black-and-white modes</b>	<ul style="list-style-type: none"> <li>• Adjust the black-and-white mode switching level, and the duration time setting.</li> </ul>	<b>Operating Instructions</b>
<b>White specks in the picture</b>	<ul style="list-style-type: none"> <li>• Use the PIX OFF function to perform blemish compensation.</li> </ul>	<b>Operating Instructions</b>
<b>Menu does not open.</b>	<ul style="list-style-type: none"> <li>• Is the camera connected correctly? See the operating instructions that come with the system controller you are using.</li> </ul>	<b>—</b>
	<ul style="list-style-type: none"> <li>• Are camera communication settings configured correctly?</li> </ul>	<b>12-15 20</b>

Problem	Cause and Recommended Action	Reference Pages
<p><b>Black line appears in the image</b></p>	<ul style="list-style-type: none"> <li>• Whether or not the connected system unit is set as multiplex vertical driver (VD2)?</li> </ul>	<p><b>7</b></p>
<p><b>Menu settings will not change.</b></p>	<ul style="list-style-type: none"> <li>• Is the password lock function turned on?</li> </ul>	<p><b>Operating Instructions</b></p>
<p><b>I forgot the password.</b></p>	<ul style="list-style-type: none"> <li>• Contact a quality service person or system installer.</li> </ul>	<p>—</p>
<p><b>Picture does not switch to black-and-white.</b></p>	<ul style="list-style-type: none"> <li>• Switching is not performed when the ALARM IN 4 setting is BW. Check the setting.</li> </ul>	<p><b>Operating Instructions</b></p>
<p><b>Pan, tilt, zoom, or focus do not work.</b></p>	<ul style="list-style-type: none"> <li>• Is the camera connected correctly? See the operating instructions that come with the system controller you are using.</li> </ul>	<p>—</p>
	<ul style="list-style-type: none"> <li>• The camera has a pan limit function. Check the PAN LIMIT settings.</li> </ul>	<p><b>Operating Instructions</b></p>
	<ul style="list-style-type: none"> <li>• The motor or lens may be worn. Contact a quality service person or system installer.</li> </ul>	<p>—</p>
<p><b>The camera movement modes (OFF, SEQ, SORT, AUTOPAN, PATROL, AUTOTRACK) do not work.</b></p>	<ul style="list-style-type: none"> <li>• Check the self return function.</li> </ul>	<p><b>Operating Instructions</b></p>
	<ul style="list-style-type: none"> <li>• Check the ALARM IN settings.</li> </ul>	<p><b>Operating Instructions</b></p>
	<ul style="list-style-type: none"> <li>• Check the recover time setting of the motion detector.</li> </ul>	<p><b>Operating Instructions</b></p>



Problem	Cause and Recommended Action	Reference Pages
<p>The camera movement modes (OFF, SEQ, SORT, AUTOPAN, PATROL, AUTOTRACK) setting changes.</p>	<ul style="list-style-type: none"> <li>• Check the self return function.</li> </ul>	<p>Operating Instructions</p>
<p>Camera position is different from the preset position setting.</p>	<ul style="list-style-type: none"> <li>• Perform REFRESH from the special setup menu.</li> </ul>	<p>Operating Instructions</p>
<p>Picture is different from the position setting.</p>	<ul style="list-style-type: none"> <li>• Adjust the picture using the preset menu and a scene file.</li> </ul>	<p>Operating Instructions</p>
<p>Upper part of the picture is black when the camera is in a horizontal orientation.</p>	<ul style="list-style-type: none"> <li>• This is caused by the camera's internal cover. It does not indicate malfunction.</li> </ul>	<p>Operating Instructions</p>
<p>Camera suddenly starts to pan by itself.</p>	<ul style="list-style-type: none"> <li>• If the cleaning function is turned on, this is normal does not indicate malfunction. Check the CLEANING settings.</li> </ul>	<p>Operating Instructions</p>
	<ul style="list-style-type: none"> <li>• If the cleaning function is not turned on, this symptom could be due to noise.</li> </ul>	<p>7, 10</p>
<p>It is hard to see images with the camera when there are raindrops on the dome cover.</p>	<ul style="list-style-type: none"> <li>• The effectiveness of the rain wash coating may have been reduced. Refer to "Cleaning this product body" in "Precautions for use" and clean the dome cover. If the situation does not improve contact your dealer.</li> </ul>	<p>8</p>

■ Periodically check the power cable.

<p>Power cable sheathing is damaged.</p>	<ul style="list-style-type: none"> <li>• The power cable is damaged. Continued use creates the risk of electric shock and fire. Immediately unplug the power plug and contact a qualified service person or system installer for servicing.</li> </ul>
<p>Power cable becomes hot during operation.</p>	
<p>Power cable becomes warm or hot when it is bent or stretched during use.</p>	

# Specifications

## ■ General

	WV-CW594A
Power Requirements	24 V AC, 60 Hz
Power Consumption	98 W
Pick-up Device	1/4-type interline transfer CCD
Effective Pixels	976 (H) × 494 (V)
Scanning Area	3.66 mm (H) × 2.74 mm (V) {5/32 inches (H) × 3/32 inches (V)}
Signal	NTSC
Synchronization	Internal (INT), multiplexed vertical drive (VD2)
Scanning	2:1 interlace
Scanning Frequencies	Horizontal: 15.734 kHz, Vertical: 59.94 Hz
Video Output	VBS: 1.0 V [p-p]/75 Ω (BNC plug)
Resolution (Center)	Horizontal: 650 TV lines typ. (Center) Vertical : 350 TV lines minimum (Center)
Minimum Illumination	0.5 lx (color mode) 0.04 lx (black-and-white mode) SENS UP: OFF; AGC: HIGH
Dynamic Range	52 dB typ. (SUPER-D6: ON)
S/N Ratio	52 dB minimum (AGC: OFF)
Ambient Operating Temperature	-50 °C to +50 °C {-58 °F to +122 °F}; Humidity 90 % max. (non-condensation)*1
Water Resistance	IP66 protection from water jets from a nozzle (IEC60529)
Dimensions	229 mm (D) × 360 mm (H) diameter of the dome: 150 mm {9-31/32 inches (D) × 14-3/16 inches (H) diameter of the dome 5-29/32 inches}
Weight	Approx. 4.5 kg {9.92 lbs} (including front and rear sunshields)
Finish	Camera: Die cast aluminium, coated (Paint color: Natural silver) Sunshield*2: ASA resin, coated ( Paint color: Natural silver) Dome cover: Clear polycarbonate resin (Rain wash coating)

\*1 When power is on continuously (however, the camera's interior temperature is -10 °C {14°F} or higher)

\*2 Sunshield cannot be removed.

## ■ Pan and Tilt

Panning Range	360° endless
Panning Modes	Manual, auto, manual position, sequential position
Panning Speed*3	Manual: Approx. 0.065 °/s to 120 °/s 8 steps, 16 steps, 64 steps Preset: Approx. 400 °/s
Tilting Range	-5° to 185° (horizontal - vertical - horizontal)
Tilting Modes	Manual, manual position, sequential position
Tilting Speed*3	Manual: Approx. 0.065 °/s to 120 °/s 8 steps, 16 steps, 64 steps Preset: Approx. 400 °/s

\*3 Actual speed depends on type of controller being used.

## ■ Lens

Zoom Ratio	36 x (Approx. 720x with digital zoom)
Focal Length	3.3 mm to 119 mm {1/8 inches to 4-21/32 inches}
Maximum Aperture Ratio	1:1.4 (WIDE) to 4.2 (TELE)
Object Distance	2.0 m {6.6 feet}
Iris Range	F1.4 to 22, Close
Angular Field of View	Horizontal: 1.7° (TELE) to 60.2° (WIDE) Vertical: 1.3° (TELE) to 46.0° (WIDE)

## ■ Main Functions

Controller Interface	Coaxial Multiplex System, RS485
Control Functions	Pan and tilt, zoom and focus, 256 preset positions, home position, patrol
AGC	ON (LOW), ON (MID), ON (HIGH), OFF
Title (ID)	ON, OFF (Preset ID, camera ID, area title: 16 alphanumeric characters)
Zoom Limit	1x to 720x (Over 36x is digital zoom)
Password Lock	All menus
Auto Focus	MANUAL/AUTO (PAN, TILT, ZOOM linked)
Iris	ALC (Adjustable OPEN/CLOSE output target level)/MANUAL
Shutter	OFF (1/60), AUTO, 1/100, 1/250, 1/500, 1/1000, 1/2000, 1/4000, 1/10000
Electronic Sensitivity Enhancement	32X max. AUTO, 512X max. FIX
Auto Mode	OFF, SEQ, SORT, AUTOPAN, PATROL, AUTOTRACK
Auto Pan Key	SEQ, SORT, AUTOPAN, PATROL, AUTOTRACK
Digital Flip	ON/OFF
SUPER-D6	ON/OFF
VMD	OFF/Motion Det/Scene Change
Alarm Input/Output	4 inputs (ALARM IN 1 to ALARM IN 4) 2 outputs (ALARM/AUX1, BW/AUX2)
Black-and-White Mode Switching	AUTO/ON/OFF
Privacy Zone	ON/OFF (8 zone settings)
Patrol	STOP/PLAY/LEARN
Cleaning	ON/OFF
Image Hold	ON/OFF
Auto Image Stabilizer	ON/OFF
Scene Select Setting	INDOOR (L) /INDOOR (H) /OUTDOOR (L) /OUTDOOR (H)
Language Setting	Japanese, English, German, French, Italian, Spanish, Russian, Chinese, Portuguese

## Standard accessories

CD-ROM* . . . . .	1 pc.
Installation Guide (this book) . . . . .	1 pc.
*The CD-ROM contains the operating instructions (PDF).	
Warranty card . . . . .	1 pc.

The following parts are used during installation procedures.

Front and rear sunshields . . . . .	1 pc. each
Front/rear sunshield fixing screw . . . . .	2 pcs. (incl. 1 spare)
Protection Cover* . . . . .	1 pc.

\*The Protection Cover is used when sending the camera for repairs, and when moving or transporting the camera. Keep it for future use.

**Panasonic i-PRO Sensing Solutions Corporation of America**

800 Gessner Rd, Suite 700 Houston, TX 77024  
<https://www.security.us.panasonic.com/>

**Panasonic Canada Inc.**

5770 Ambler Drive, Mississauga, Ontario, L4W 2T3 Canada  
1-877-495-0580  
<https://www.panasonic.com/ca/>