

# Panasonic

## Installation Guide Color CCTV Camera

Model No: **WV-CF614E Series**  
**WV-CF344E Series**

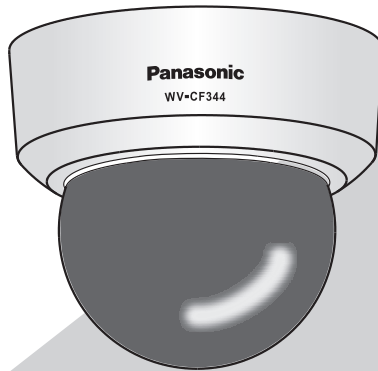

This illustration represents WV-CF344E.

This manual covers the models:WV-CF614E Series (WV-CF634E, WV-CF614E) and WV-CF344E Series (WV-CF374E, WV-CF354E, WV-CF344E).

Before attempting to connect or operate this product,  
please read these instructions carefully and save this manual for future use.

The model number is abbreviated in some descriptions in this manual.

We declare under our sole responsibility that the product to which this declaration relates is in conformity with the standard or other normative document following the provisions of Directive 2004/108/EC.

Wij verklaren als enige aansprakelijke, dat het product waarop deze verklaring betrekking heeft, voldoet aan de volgende norm of ander normatief document, overeenkomstig de bepalingen van Richtlijn 2004/108/EC.

Vi erklærer os eneansvarlige for, at dette produkt, som denne deklaration omhandler, er i overensstemmelse med standard eller andre normative dokumenter i følge bestemmelserne i direktiv 2004/108/EC.

Vi deklarerar härmed vårt fulla ansvar för att den produkt till vilken denna deklaration hänvisar är i överensstämmelse med standarddokument eller annat normativt dokument som framställs i direktiv 2004/108/EC.

Ilmoitamme yksinomaisella vastuullamme, että tuote, jota tämä ilmoitus koskee, noudattaa seuraavaa standardia tai muuta ohjeellista asiakirjaa, jotka noudattavat direktiivin 2004/108/EC säädöksiä.

Vi erklærer oss alene ansvarlige for at produktet som denne erklæringen gjelder for, er i overensstemmelse med følgende norm eller andre normgivende dokumenter som følger bestemmelsene i direktiv 2004/108/EC.

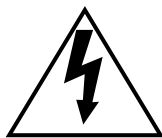
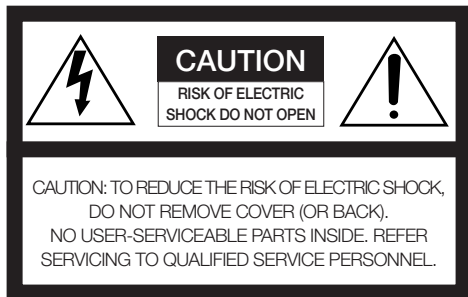

The lightning flash with arrowhead symbol, within an equilateral triangle, is intended to alert the user to the presence of uninsulated "dangerous voltage" within the product's enclosure that may be of sufficient magnitude to constitute a risk of electric shock to persons.







The exclamation point within an equilateral triangle is intended to alert the user to the presence of important operating and maintenance (servicing) instructions in the literature accompanying the appliance.

#### **WARNING:**

- To prevent fire or electric shock hazard, do not expose this apparatus to rain or moisture.
- The apparatus should not be exposed to dripping or splashing and that no objects filled with liquids, such as vases, should be placed on the apparatus.
- All work related to the installation of this product should be made by qualified service personnel or system installers.
- To prevent injury, this apparatus must be securely attached to the floor/wall/ceiling in accordance with the installation instructions.
- The installation shall be carried out in accordance with all applicable installation rules.
- This product has no power switch. When turning off the power, turn off a Power Supply or remove a power cable.
- The connections should comply with local electrical code.

# Contents

Important safety instructions.....	4
Limitation of liability.....	5
Disclaimer of warranty.....	5
Preface.....	6
About notations.....	6
Features.....	6
About the user manuals.....	7
Trademarks and registered trademarks.....	7
Precautions.....	8
Precautions for installation.....	10
Major operating controls and their functions.....	12
Preparations.....	13
Remove the dome cover.....	13
About the side cable access hole.....	14
Installation method of camera.....	14
Connections.....	15
Installation.....	17
Adjustment.....	18
Attaching the dome cover.....	22
Setup menu.....	24
List of setup menu.....	24
Basic operation.....	25
Screen transition diagram  .....	27
Screen transition diagram  .....	28
Screen transition diagram  .....	29
Screen transition diagram  .....	30
Screen transition diagram  .....	31
Troubleshooting.....	32
Specifications.....	33
Standard accessories.....	34

# Important safety instructions

- 1) Read these instructions.
- 2) Keep these instructions.
- 3) Heed all warnings.
- 4) Follow all instructions.
- 5) Do not use this apparatus near water.
- 6) Clean only with dry cloth.
- 7) Do not block any ventilation openings. Install in accordance with the manufacturer's instructions.
- 8) Do not install near any heat sources such as radiators, heat registers, stoves, or other apparatus (including amplifiers) that produce heat.
- 9) Protect the power cord from being walked on or pinched particularly at plugs, convenience receptacles, and the point where they exit from the apparatus.
- 10) Only use attachments/accessories specified by the manufacturer.
- 11) Use only with the cart, stand, tripod, bracket, or table specified by the manufacturer, or sold with the apparatus. When a cart is used, use caution when moving the cart/ apparatus combination to avoid injury from tip-over.



- 12) Refer all servicing to qualified service personnel. Servicing is required when the apparatus has been damaged in any way, such as power-supply cord or plug is damaged, liquid has been spilled or objects have fallen into the apparatus, the apparatus has been exposed to rain or moisture, does not operate normally, or has been dropped.

## Limitation of liability

THIS PUBLICATION IS PROVIDED "AS IS" WITHOUT WARRANTY OF ANY KIND, EITHER EXPRESS OR IMPLIED, INCLUDING BUT NOT LIMITED TO, THE IMPLIED WARRANTIES OF MERCHANTABILITY, FITNESS FOR ANY PARTICULAR PURPOSE, OR NON-INFRINGEMENT OF THE THIRD PARTY'S RIGHT.

THIS PUBLICATION COULD INCLUDE TECHNICAL INACCURACIES OR TYPOGRAPHICAL ERRORS. CHANGES ARE ADDED TO THE INFORMATION HEREIN, AT ANY TIME, FOR THE IMPROVEMENTS OF THIS PUBLICATION AND/OR THE CORRESPONDING PRODUCT (S).

## Disclaimer of warranty

IN NO EVENT SHALL Panasonic i-PRO Sensing Solutions Co., Ltd. BE LIABLE TO ANY PARTY OR ANY PERSON, EXCEPT FOR REPLACEMENT OR REASONABLE MAINTENANCE OF THE PRODUCT, FOR THE CASES, INCLUDING BUT NOT LIMITED TO BELOW:

- (1) ANY DAMAGE AND LOSS, INCLUDING WITHOUT LIMITATION, DIRECT OR INDIRECT, SPECIAL, CONSEQUENTIAL OR EXEMPLARY, ARISING OUT OF OR RELATING TO THE PRODUCT;
- (2) PERSONAL INJURY OR ANY DAMAGE CAUSED BY INAPPROPRIATE USE OR NEGLIGENT OPERATION OF THE USER;
- (3) UNAUTHORIZED DISASSEMBLE, REPAIR OR MODIFICATION OF THE PRODUCT BY THE USER;
- (4) INCONVENIENCE OR ANY LOSS ARISING WHEN IMAGES ARE NOT DISPLAYED, DUE TO ANY REASON OR CAUSE INCLUDING ANY FAILURE OR PROBLEM OF THE PRODUCT;
- (5) ANY PROBLEM, CONSEQUENTIAL INCONVENIENCE, OR LOSS OR DAMAGE, ARISING OUT OF THE SYSTEM COMBINED BY THE DEVICES OF THIRD PARTY;
- (6) ANY CLAIM OR ACTION FOR DAMAGES, BROUGHT BY ANY PERSON OR ORGANIZATION BEING A PHOTOGENIC SUBJECT, DUE TO VIOLATION OF PRIVACY WITH THE RESULT OF THAT SURVEILLANCE-CAMERA'S PICTURE, INCLUDING SAVED DATA, FOR SOME REASON, BECOMES PUBLIC OR IS USED FOR ANY PURPOSE.

# Preface

This product is a 1/3-type CCD color CCTV camera. Connection of this product to a video monitor allows users to use this product as a monitoring camera.

- WV-CF634E: with super dynamic 6 function, color / black-and-white mode switch function and focus adjustment function
- WV-CF614E: with super dynamic 6 function, easy black-and-white mode switch function and focus adjustment function
- WV-CF374E: with color / black-and-white mode switch function
- WV-CF354E: with easy black-and-white mode switch function and focus adjustment function
- WV-CF344E: with easy black-and-white mode switch function

## About notations

The following notations are used when describing the functions limited for specific models. The functions without the notations are supported by all models.

- CF634**: The functions with this notation are available when using the model WV-CF634E.
- CF614**: The functions with this notation are available when using the model WV-CF614E.
- CF374**: The functions with this notation are available when using the model WV-CF374E.
- CF354**: The functions with this notation are available when using the model WV-CF354E.
- CF344**: The functions with this notation are available when using the model WV-CF344E.

## Features

### Introduction of newly developed high-resolution CCD

The introduction of the newly developed CCD with 976 horizontal pixels has led to a horizontal resolution of as high as 650 TV lines.

### Super Dynamic 6 (SUPER-D6) **CF634** **CF614**

For photographic subjects which contain high contrast between the bright and dark areas, light compensation on the pixel level will result in more natural-looking images.

### High sensitivity achieved because of noise reduction function

Sensitivity at the following minimum illuminations has been accomplished for color images because of the introduction of low noise circuit design (Lens (built-in): F1.3):

- 0.08 lx (color), 0.008 lx (black-and-white) **CF634** **CF374**
- 0.08 lx (color), 0.05 lx (black-and-white) **CF614** **CF354** **CF344**

### **Day/Night conversion function equipped**

No setup change is required at night because the image automatically changes from the color mode to the black-and-white mode at low illuminance.

Bright images can be captured even at night because of automatic switching of IR filters at low illuminance.

### **Focus adjustment function equipped**

Auto focus is achieved at installation of the camera or through menu operation.

### **Motion detection function (VMD) equipped**

The motion of an object is detectable. The acts of covering the camera with a cloth, a cap or other acts and changing the camera direction during surveillance can be detected.

---

#### **Note:**

- The VMD function is not the dedicated function to prevent thefts, fires, etc. We are not responsible for any accidents or damages caused by applying the function for the above purposes.
- 

## **About the user manuals**

The operating instructions of the camera consist of 2 sets: this book and operating instructions (PDF).

This book explains how to install the camera.

Refer to the "Operation Instructions (PDF)" on the provided CD-ROM for descriptions of how to perform the unit settings. Adobe® Reader® is required to read PDF. When the Adobe® Reader® is not installed on the PC, download the latest Adobe® Reader® from the Adobe web site and install it.

## **Trademarks and registered trademarks**

Adobe, Acrobat Reader and Reader are either registered trademarks or trademarks of Adobe Systems Incorporated in the United States and/or other countries.

# Precautions

## **Refer installation work to the dealer.**

Installation work requires technique and experiences. Otherwise injury or damage to this product may result.

Be sure to consult the dealer.

## **Do not insert any foreign objects.**

This could permanently damage this product.

Turn the power off immediately and contact qualified service personnel for service.

## **Do not attempt to disassemble or modify this product.**

Failure to observe this may cause fire or electric shock.

Consult the dealer for the repair or inspections.

## **Stop operation immediately when something is wrong with this product.**

When smoke goes up from this product or the smell of smoke comes from this product, continued use will result in fire, injury, or damage to the product.

Turn the power off immediately and contact qualified service personnel for service.

## **Select an installation area that can support the total weight.**

Selecting an inappropriate installation surface may cause the product to fall down or topple over, resulting in injury.

Installation work shall be started after sufficient reinforcement.

## **Periodic inspections shall be conducted.**

Rust on the metal parts or screws may cause the product to fall down resulting in injury or accidents.

Consult the dealer for the inspections.

## **This product shall be installed in a vibration-free place.**

Failure to observe this may cause screws and bolts to be loosened and consequently to fall

resulting in injury.

## **Install this product in a location high enough to avoid people and objects from bumping the product.**

Failure to observe this may cause a drop resulting in injury or accidents.

## **Do not strike or give a strong shock to this product.**

Failure to observe this may cause injury or fire.

## **Turn the power off when do wiring of this product.**

Failure to observe this may cause electric shock. A short circuit or wrong wiring may cause fire.

## **Do not use this product in an atmosphere of flammable gases.**

Failure to observe this may cause injury by explosion.

## **Avoid installing this product in locations where it is subject to damage by salt or corrosive gas.**

Otherwise the mounting fixtures will deteriorate, causing the product to fall down and leading to accidents.

## **Tighten screws and mounting fixtures to the specified torque.**

Failure to observe this may cause a drop resulting in injury or accidents.

## **[Precautions for use]**

### **This product is designed to be used indoors.**

This product is not operable outdoors.

### **This product has no power switch.**

When turning off the power, turn off a circuit breaker.



### **To keep on using with stable performance**

Parts of this product may deteriorate and it may shorten the lifetime of this product when using in locations subject to high temperatures and high humidity. (Recommended operating temperature: +35 °C or lower)

Do not expose this product to direct heat sources such as a heater.

### **Handle this product with care.**

Do not drop this product, nor apply shock or vibration to this product.

Failure to observe this may cause trouble.

### **Do not touch the dome cover with your bare hands.**

A dirty dome cover causes deterioration of picture quality.

### **Noise on monitor**

This product is equipped with a super sensitive CCD. Therefore, noise may appear on the monitor. This phenomenon is not trouble.

### **Discoloration on the CCD color filter**

When continuously shooting a bright light source such as a spotlight, the color filter of the CCD may have deteriorated and it may cause discoloration. Even when changing the fixed shooting direction after continuously shooting a spotlight for a certain period, the discoloration may remain.

### **Do not aim this product at strong light sources.**

A light source such as a spot light causes a blooming (light bleeding) or a smear (vertical lines).

### **Cleaning this product body**

Turn the power off when cleaning this product. Do not use strong abrasive detergent when cleaning this product. Otherwise, it may cause discoloration.

### **Synchronous mode setting**

Image synchronous mode of this camera indicates internal synchronization (INT) only. Set the multiplexed vertical drive (VD2) as OFF when the camera is connected to the system controller of the company.

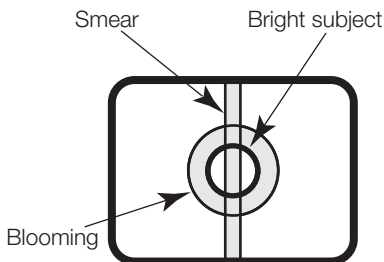

# Precautions for installation

**Panasonic assumes no responsibility for injuries or property damage resulting from failures arising out of improper installation or operation inconsistent with this documentation.**

**This product is designed to be used indoors.**

This product is not operable outdoors. Do not expose the product to direct sunlight for hours and do not install the product near a heater or an air conditioner. Otherwise, it may cause deformation, discoloration and malfunction. Keep the product away from water and moisture.

## **Installing place**

Contact your dealer for assistance if you are unsure of an appropriate place in your particular environment.

- Make sure that the installation area is strong enough to hold the product, such as a concrete ceiling.
- Install the camera in the foundation area of the architecture or where sufficient strength is assured.
- If a ceiling board such as plaster board is too weak to support the total weight, the area shall be sufficiently reinforced.

**Avoid installing this product in the following locations.**

- Location where it may get wet from rain or water splash.
- Locations where a chemical agent is used such as a swimming pool.
- Locations subject to steam and oil smoke such as a kitchen.
- Locations near flammable gas or vapor.
- Locations where radiation or x-ray emissions are produced.
- Locations where corrosive gas is produced, Locations where it may be damaged by briny air such as seashores.

- Locations where the temperature is not within  $-10\text{ }^{\circ}\text{C}$  to  $+50\text{ }^{\circ}\text{C}$ .
- Locations subject to vibrations (This product is not designed for on-vehicle use.)
- Locations subject to condensation as the result of severe changes in temperature (In case of installing the product in such locations, the dome cover may become foggy or condensation may be caused on the cover.)

**Avoid moist or dusty places to install this system.**

Otherwise, lifetime of the internal parts may be shortened.

**Avoid installing this product in a place with a high level of noise.**

Installation near an air conditioner, an air cleaner, a vending machine, or the like causes noise.

**Avoid installing and connecting during a lightning storm. Otherwise, an electric shock or fire may be caused.**

**Be sure to remove this product if it is not in use.**

**Do not damage the power plug or cable.**

**Keep the camera cable away from the lighting cable.**

Failure to observe this may cause noise.

## **Radio interference**

When the camera is used near TV/radio antenna, strong electric field or magnetic field (near a motor or a transformer), images may be distorted and noise sound may be produced. In such a case, run the camera cable through specialized steel conduit tubes.

### **Locally procure the screws**

Screws are not supplied with this product. Prepare the screws according to the material, structure, strength and other factors of the mounting area and the total weight of objects to be mounted.

### **Screw tightening**

- The screws and bolts must be tightened with an appropriate tightening torque according to the material and strength of the installation area.
- Do not use an impact driver. Failure to observe this may cause overtightening and consequently damage to the screws.
- When a screw is tightened, make the screw at a right angle to the surface. After tightening the screws or bolts, perform visual check to ensure tightening is enough and there is no backlash.

# Major operating controls and their functions

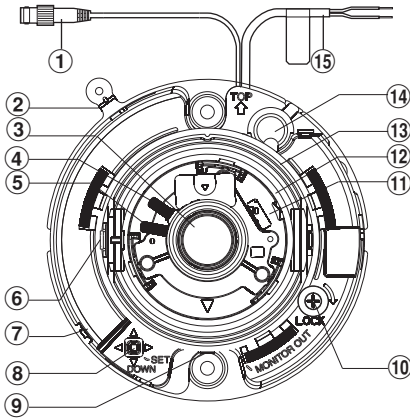

## ① Video output connector

Transmits composite video signals.

## ② Mark

This mark is used when the dome cover is installed.

## ③ Lens

## ④ Focus knob (with lock function) CF374 CF344

Locks the focus position after focus adjustment.

## ⑤ Zoom knob (with lock function)

Locks the zoom position after zoom adjustment.

## ⑥ Tilting lock screw

Fixes the tilting position.

## ⑦ AF button [AF] CF634 CF614 CF354

☞ page 21.

## ⑧ Setup button [SET]

Press the [SET] button once and the "FOCUS ADJUSTMENT" screen will be displayed. CF374 CF344

Hold down the [SET] button for more than 2 seconds and the setup menu will be displayed.

- [LEFT] / [RIGHT]: Press the [RIGHT] or [LEFT] button to move to the right or left in the menu, or change the displayed values.
- [UP] / [DOWN]: Press the [UP] or [DOWN] button to move up or down in the menu.

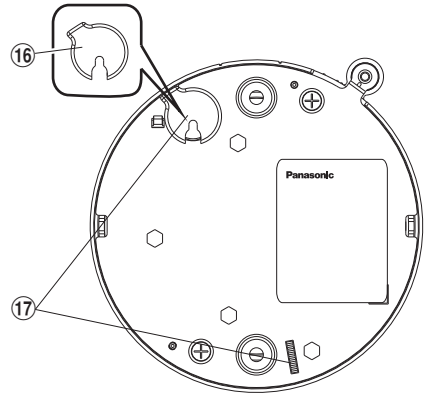

(This illustration represents WV-CF344E.)

- [SET]: Press this button in the menu to confirm the selected value or function. In addition, this button is used to open submenus.

## ⑨ Adjustment monitor output jack

Connect the adjustment monitor (small LCD monitor, etc.) to the adjustment monitor output jack to adjust the camera angle.

## ⑩ Panning table lock screw [LOCK]

Locks the panning position after adjustment.

## ⑪ Azimuth adjuster

Adjusts the azimuth angle of the camera.

## ⑫ Tilting table

Adjusts the tilting position of the camera.

## ⑬ Panning table

Adjusts the panning position of the camera.

## ⑭ Cable access hole

## ⑮ Power cord

Supplies 24 V AC or 12 V DC from an external power source.

## ⑯ Dust guard cap

A rubber cap which prevent dust go into the camera through the cable access hole.

## ⑰ Fingerplate

This is where to put your fingers when removing the dome cover.

# Preparations

When installing the camera on a wall or ceiling, there are three methods as specified below.

- Use the one-gang junction box
- Installing the camera directly on a wall or ceiling
- Using the optional ceiling mount bracket WV-Q174E (for embedded installation on a ceiling)

## Important:

- Procure 2 screws (M4) to secure the camera to a wall or ceiling according to the material of the installation area. Do not use wood screws and nails. For mounting a camera on a concrete wall or ceiling, use an anchor bolt (M4) for securing.  
(Recommended tightening torque M4: 1.6 N·m)
- Required pull-out strength of a single screw/bolt is 196 N or more.
- If a ceiling board such as plaster board is too weak to support the total weight, the installation area shall be sufficiently reinforced.
- The protection sheet attached to the dome section should be peeled off after installation.

The mounting conditions of the camera are described as follows:

Installation place	Applicable mount bracket	Recommended screw	Number of screw	Minimum pull-out strength (per 1 pc.)
Ceiling / wall	One-gang junction box (locally procured)	M4	2 pcs.	196 N
Ceiling / wall	(Direct mounting)	M4	2 pcs.	196 N
Ceiling	WV-Q174E (approx. 310 g)	-	-	*1

\*1 Make sure that the installed mount bracket can support more than 5 times of the weight of the camera.

## Remove the dome cover

- ① Peel off the protection sheet from the dome cover. Don't remove completely as this protects the dome during installation.
- ② Loosen the dome cover fixing screw.
- ③ Adjust the mark on this unit to [ ] on the dome cover, and turn the dome cover counterclockwise to remove it.

### Note:

- The clear dome cover and the inner dome are joined into a single unit. Therefore, never try to remove them.

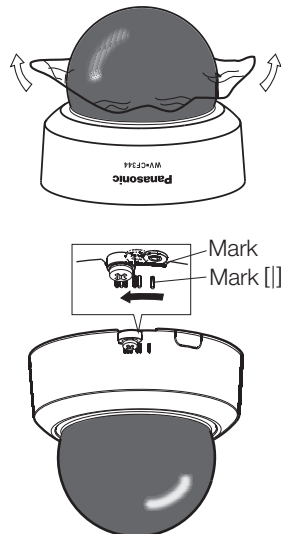

## ■ About the side cable access hole

If you choose not to drill hole in the wall or ceiling, but to wire the camera with the cable exposed, cut the cable access hole on the side of the dome cover to provide a cable entry.

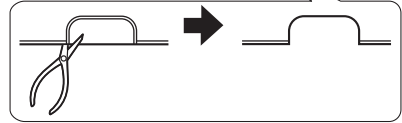
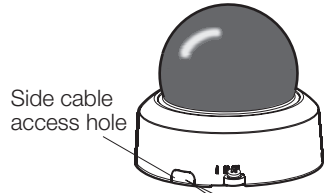

### Precautions when wiring from the side:

- Remove the dust guard cap. Run the cable through the cable access hole and bend it inward, then reinstall the dust guard cap.
- Move the cable to one side as shown.
- Be careful not to pinch the cable with the dome cover.

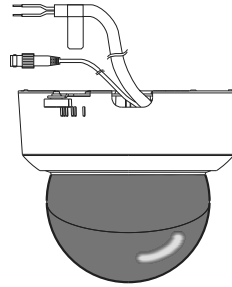
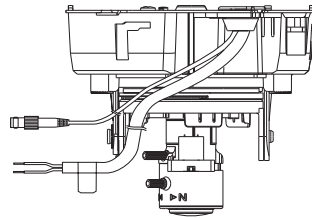

## ■ Installation method of camera

### Using a gang junction box (locally procured)

When using a gang junction box (101.6 mm x 60.3 mm), procure one locally that meets the dimensions in the figure.

Next locally procure 2 camera-mounting screws suitable for the installation surface and structure of the wall/ceiling or gang junction box.

- ① Attach the gang junction box to the wall or ceiling.
- ② Attach the camera to the gang junction box with the 2 screws (locally procured).
- ③ Tighten all mounting screws.

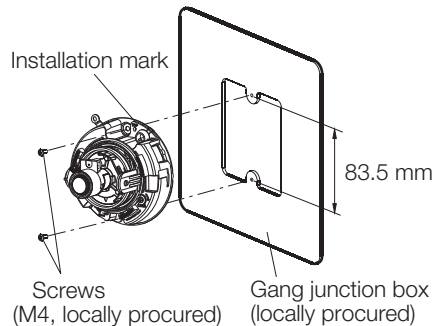

## Installing the camera directly on a wall or ceiling

Affix the installation template label (accessory) to the ceiling or wall, and use a pen to mark the positions of the screws and cable mounting hole in the ceiling or wall.

Remove the installation template label, and attach the camera with 2 screws (M4, locally procured).

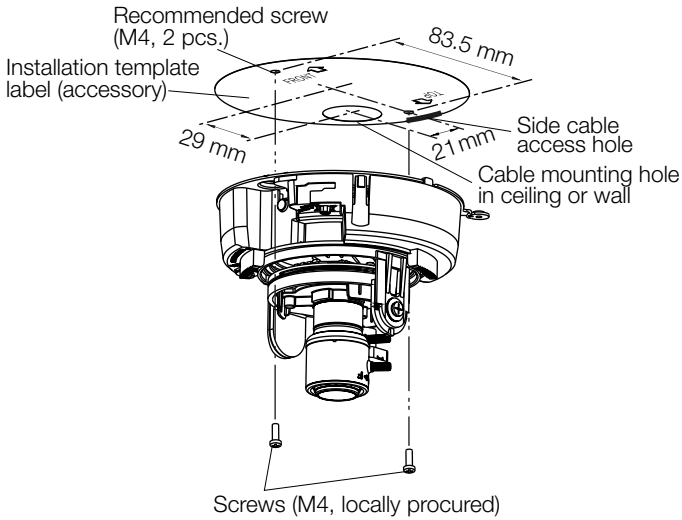

## Connections

### Connect the video output

#### Important:

- Be sure to turn off the power of each device before connecting.
- Be sure to secure the coaxial cable connectors.

Connect a coaxial cable (locally procured) to the video output connector.

### Connect the power supply

Connect the two-color conductor cable of the camera to the power supply. The colors and functions of the conductors are shown below.

Color	12 V DC	24 V AC
Brown	Positive	Live
Blue	Negative	Neutral

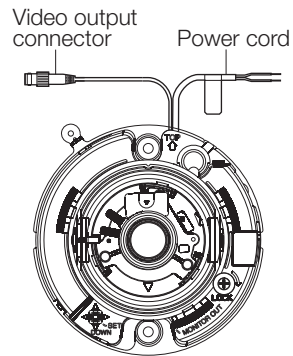

---

**Important:**

- The power supply of 24 V AC/12 V DC shall be insulated against 220 to 240 V AC.
  - The power supply is automatically switchover either 24 V AC or 12 V DC. No setting is required with this camera.
- 

**Connection of power cord**

When connecting the power cord, use connectors that are designed for the power cord, and be careful not to let the power cord fall off.

In addition, waterproofing work is needed at the joint, e.g., wrapping waterproof tape around the joint.

**Cable length and wire gauge****24 V AC**

The recommended cable length and wire gauge are shown in the table for reference. The voltage supplied to the power terminals of the camera should be within 19.5 V AC and 28 V AC.

The recommended wire size for 24 V AC power cord is shown below:

Copper wire size (AWG)		#24 (0.205 mm <sup>2</sup> )	#22 (0.325 mm <sup>2</sup> )	#20 (0.519 mm <sup>2</sup> )	#18 (0.833 mm <sup>2</sup> )	#16 (1.307 mm <sup>2</sup> )
Length (approx.)	(m)	20	30	45	75	120

**12 V DC**

Calculation of the relation among the cable length, resistance, and power supply.

The voltage supplied to the camera shall be between 10.8 V DC and 16 V DC.

$$10.8 \text{ V DC} \leq V_A - 2 (R \times I \times L) \leq 16 \text{ V DC}$$

L : Cable length (m)

R : Resistance of copper wire ( $\Omega$ /m)

V<sub>A</sub> : DC output voltage of power supply unit

I : DC current consumption (A)

See specifications.

Resistance of copper wire [at 20 °C]

Copper wire size (AWG)	#24 (0.205 mm <sup>2</sup> )	#22 (0.325 mm <sup>2</sup> )	#20 (0.519 mm <sup>2</sup> )	#18 (0.833 mm <sup>2</sup> )	#16 (1.307 mm <sup>2</sup> )
Resistance $\Omega$ /m	0.083	0.052	0.033	0.020	0.013



# Installation

## Installation of camera

Turn off the power of all related devices before installation.

- 1 Remove the dome cover.
- 2 Connect all cables.  
If necessary, bind the cable with cable tie (locally procured).
- 3 Install the camera (The illustration below shows installation using a gang junction box (locally procured) ).  
Mount the camera with 2 screws (M4, locally procured).

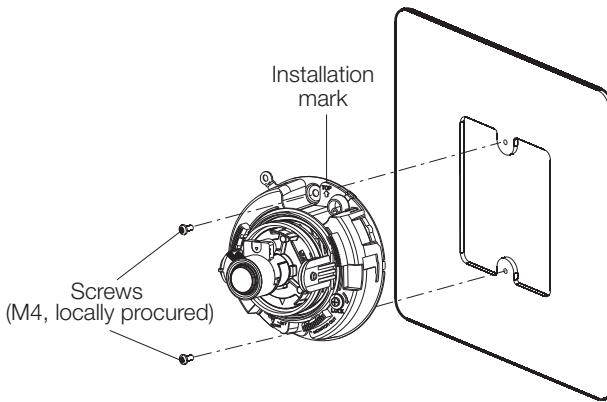

---

### Important:

- Be sure to avoid twisting the cables when tightening the screws.
- 

### Note:

- When attached to the ceiling:  
Install the camera with its front (Model number indication face) facing the direction opposite to the “↑TOP” arrow of the installation mark (“↑FRONT” direction of the installation template label in the accessories).
  - When attached to the wall:  
Install the camera with the “↑TOP” arrow of the installation mark facing upward.
-

# Adjustment

- 1 Connect the  $\varnothing 3.5$  mm miniature plug (mono channel) to the adjustment monitor output jack.

---

## Important:

- This video output is intended for confirmation of view angle, etc. during installation or repair service, and not for recording or monitoring.
- 

## Note:

- Video cannot be output through the video output cable after connecting the adjustment monitor.
- 

- 2 Pan, tilt and azimuth adjustment

---

## Important:

- When adjusting pan, tilt or azimuth, do not hold the lens of the camera.
- 

### ① Adjustment of panning position

Loosen the panning table lock screw and rotate the table to determine the panning position (adjustable range:  $350^\circ$ ).

- The panning position can be adjusted between  $+180^\circ$  (clockwise) and  $-170^\circ$  (counter-clockwise).
  - After the panning position is determined, fix the panning table with the panning table lock screw.
- (Recommended torque: 0.39 N·m)

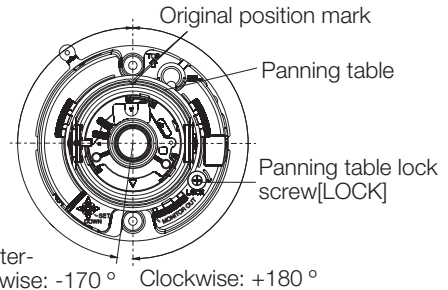

### ② Adjustment of tilting position

Turn the tilting table to adjust the tilting position of the camera. (adjustable range:  $\pm 90^\circ$ )

- The view angle can be adjusted as the camera uses vari-focal lens.
  - Tighten the tilting lock screw after adjustment.
- (Recommended torque: 0.59 N·m)

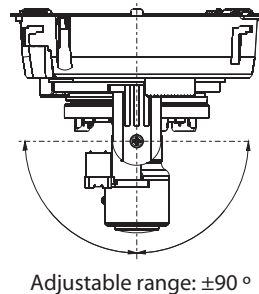

### ③ Adjustment of azimuth

Adjust the azimuth by rotating the azimuth adjuster. (adjustable range:  $\pm 100^\circ$ )

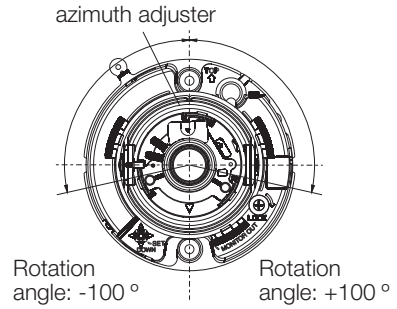

---

#### Note:

- Adjust azimuth so that the image top mark is facing "Δ" to display the image properly rather than upside-down.

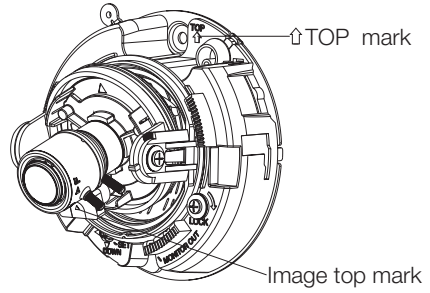
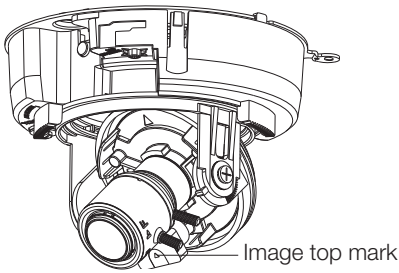

### 3 Zoom and focus adjustment

Perform the zoom and focus adjustments at the same time as pan and tilt adjustments (Step 2).

#### Note:

- If the camera is used in near-horizontal position, the shadow of the dome cover may appear in the image.

#### <Adjustment on WV-CF344E, WV-CF374E>

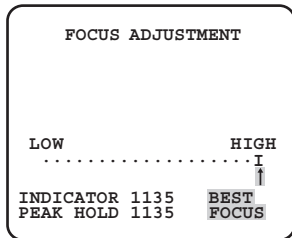
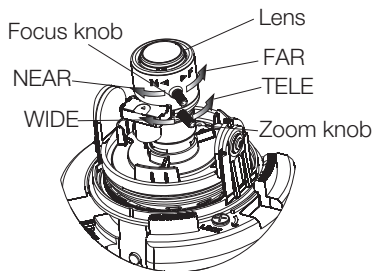

- ① Loosen the zoom knob and focus knob. Select photographic subject and choose proper view angle through zooming. Adjust the zoom and focus rings to make the image clear (approximate adjustment).

#### Note:

- The focus may not be adjusted smoothly when the zoom ring is extremely close to the end of W direction (T direction). At this time, slightly adjust the zoom ring towards the T direction (W direction), and then adjust the focus.

- ② Tighten the zoom knob.
- ③ Press the [SET] button.  
→ The "FOCUS ADJUSTMENT" screen will appear.  
The focus assist function will be activated to perform the optimum adjustment.
- ④ When the focus ring is positioned near the best focus position, the position will automatically be memorized as the "PEAK HOLD" position (the higher the value is, the closer it is to the focus point).
- ⑤ When the focus ring is moved, the current focus position will be indicated on "INDICATOR".  
Adjust the focus position so that the indicator value goes close to the "PEAK HOLD" position.
- ⑥ When the indicator value goes to the best focus position, "BEST FOCUS" will be displayed in reverse at the lower right corner of the screen.
- ⑦ Press the [SET] button again to close the "FOCUS ADJUSTMENT" menu. (No operation for 3 minutes also closes the menu.)

#### Important:

- If the view angle changes during adjustment, press the [SET] button to close the "FOCUS ADJUSTMENT" screen (once the view angle changes, the "PEAKHOLD" and "INDICATOR" values will also change), and repeat from step ④ after the view angle is fixed.

---

**Important:**

- When shooting in the following place or following subjects, press the [SET] button again to close the “FOCUS ADJUSTMENT” screen, or adjust to the best focus position while viewing the image.
  - Frequently moving subject
  - Subject with large illuminance change
  - Subject with low illuminance
  - Too bright or reflective subject
  - Subject through a window
  - Place where the lens easily becomes dirty
  - Subject with less contrast such as white wall
  - Subject with remarkable depth
  - Subject with heavy flicker
  - Subject with horizontally parallel lines such as a shutter
- 

**<Adjustment on WV-CF634E, WV-CF614E, WV-CF354E>**

- ① Loosen the zoom knob and adjust to the best view angle between TELE and WIDE.
- 

**Note:**

- The focus may not be adjusted smoothly when the zoom adjustment ring is extremely close to the end of W direction (T direction). At this time, slightly adjust the zoom adjustment ring towards the T direction (W direction), and then adjust the focus.
- 

- ② Tighten the zoom knob.
  - ③ Rotate the front of the lens, and adjust to the best view angle between NEAR and FAR.
  - ④ Press the [AF] button on the side of the camera, which will automatically focus.
- 

**Note:**

- The AF function is not available over the entire focus range. Be sure to perform approximate adjustment of the view angle before manual focusing, and then press the [AF] button to enable the AF function.
  - For the following subjects, select ELC control method, and then manually adjust the focus.
    - Fast-moving subject
    - Subject with significant illuminance change
    - Subject with low illuminance (such as high beam light)
    - Too bright or reflective subject
    - Subject behind a window
    - Less contrasty subject (such as white wall)
    - Subject with remarkable depth
    - Subject with flicker
    - Subject with parallel lines (such as a shutter)
    - Blurred or dirty spherical cover
-

# Attaching the dome cover

- 1** Align the mark with [I] on the dome cover, and then install the dome cover.

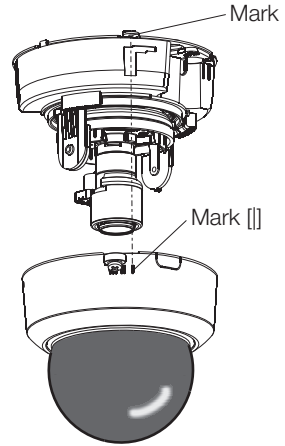

- 2** Adjust the orientation of the dome cover.

Turn the enclosure clockwise so that the mark aligns with [II].

Turn the dome cover to the left or right while viewing the monitor so that the light is not blocked.

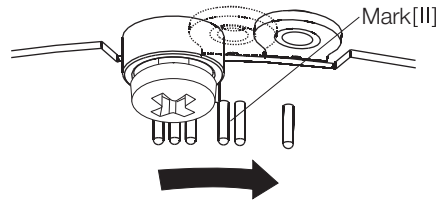

---

## Important:

- Be sure to align the mark with [II] when adjusting the dome cover. Do not apply excessive force, or you may cause damage.
- 

- 3** Turn the dome cover clockwise so that the mark aligns with [III].

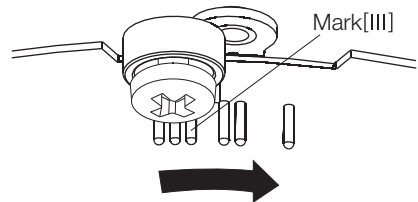

- 4** Fix the dome cover and camera body with the dome cover fixing screw (M3).  
(Recommended torque: 0.59 N·m)

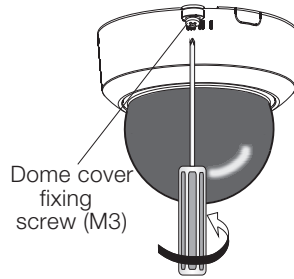

- 5** After finishing the installation, completely peel off the protection sheet that had been retained on the camera.



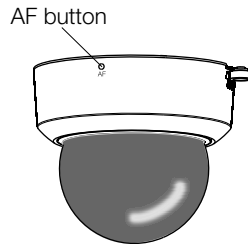

- 6** Press the [AF] button again to adjust the focus. **CF634** **CF614** **CF354**  
For more information, refer to page 21.



# Setup menu

Performing each setting item in the setup menu should be completed in advance to use this unit. Perform the settings for each item in accordance with the conditions of the camera shooting area.

## List of setup menu

Setup item	Description
<b>CAMERA ID</b>	This item specifies the camera title. The camera title that indicates the camera location and other information about the camera is created with alphanumeric characters and symbol, and then displayed on the screen.
<b>CAMERA</b>	Performs the camera operation settings.
SCENE 1/ SCENE 2	Selects a scene file. It is possible to register and save the settings as a scene file in case that it is necessary to change the settings such as when shooting at night.
ALC/ELC	Selects the method of controlling the quantity of light in accordance with the lens to be used.
SHUTTER	Specifies the electronic shutter speed.
AGC	Specifies gain adjustment.
SENS UP	Specifies electronic sensitivity enhancement.
WHITE BAL	Specifies white balance adjustment.
DNR	Selects the level of the digital noise reduction function.
D&N (IR/ELE)	Performs each setting regarding the black-and-white mode such as switching between color and black-and-white images.
VMD	Performs settings regarding VMD (Video Motion Detection)
<b>SYSTEM</b>	Performs the settings regarding the camera system such as synchronization and privacy zone.
SYNC	Only INT method can be used; VD2 synchronization cannot be used.
PRIVACY ZONE	Hides undesired portions in the camera shooting area.
STABILIZER	Decides whether or not to enable the image stabilizer.
EL-ZOOM	Switches the electronic zoom on and off.
UPSIDE-DOWN	Flips the camera images vertically or horizontally.
LDC	Adjusts the lens distortion correction to convert the image so that it matches the square monitor.
FOCUS 	Selects the adjustment method and fine adjustment method for focus.
<b>BACK-FOCUS</b>  	Selects the adjustment method and fine adjustment method for back focus.
<b>SPECIAL</b>	
CHROMA GAIN	Adjusts the chroma level (color density).
AP GAIN	Adjusts the aperture level.
PEDESTAL	Adjusts the pedestal (brightness) level.
DISPLAY  	Performs the image display setting.
PIX OFF	Corrects image defects such as flaws.
CAMERA RESET	Restores the settings in the setup menu to the default settings.
SER.NO.	Displays the serial number of this product.
<b>LANGUAGE</b>	Selects a language to be used in the setup menu.



# Basic operation

The operations in the setup menu are performed with the operation buttons after calling up the setup menu on the connected video monitor.

The description below explains how to operate the setup menu basically.

Screenshots of WV-CF354E are shown as an example.

## Screenshot 1

Hold down the [SET] button for about 2 seconds to call up the top screen of the setup menu.

```
MODEL   WV-CF354
CAMERA ID   OFF
CAMERA }
SYSTEM }
SPECIAL }
LANGUAGE }

END   SETUP  DISABIE
```

## Step 1

Press the [UP] or [DOWN] button to move the cursor to "END".

## Step 2

Press the [RIGHT] button to move the cursor to "SETUP", and press the [SET] button to change the setup mode from "DISABLE" to "ENABLE".

## Screenshot 2

The setup mode changes to "ENABLE", and the setup menu becomes ready to be set.

```
MODEL   WV-CF354
CAMERA ID   OFF
CAMERA }
SYSTEM }
SPECIAL }
LANGUAGE }

END   SETUP  ENABLE
```

## Step 3

Move the cursor to the item to be set, and press the [SET] button.

### Screenshot 3

The selected setup screen in the setup menu appears on the screen.

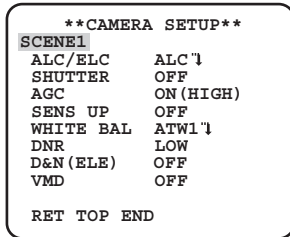

---

#### Note:

- If the top screen of the setup menu is called up with the operation buttons, the setup mode is always "DISABLE" to prevent operation errors.  
To perform settings in the setup menu, change the setup mode to "ENABLE".
  - The cursor is a reversely highlighted part.
- 

### Step 4

Perform the settings for each item.

- **Selection of setting item:**  
Press the [UP] or [DOWN] button to move the cursor.
- **Change of settings:**  
Press the [RIGHT] or [LEFT] button.
- **Display of advanced setup screen:**  
Press the [SET] button when "↵" is attached to the target setting item.
- **Return to previous setup screen:**  
Move the cursor to "RET" and press the [SET] button.
- **Return to the top screen:**  
Move the cursor to "TOP" and press the [SET] button, to display the top screen of the setup menu.

### Step 5

Move the cursor to "END" and press the [SET] button to return to the camera image screen, or wait about 5 minutes and the setup menu will automatically close.

# Screen transition diagram CF634

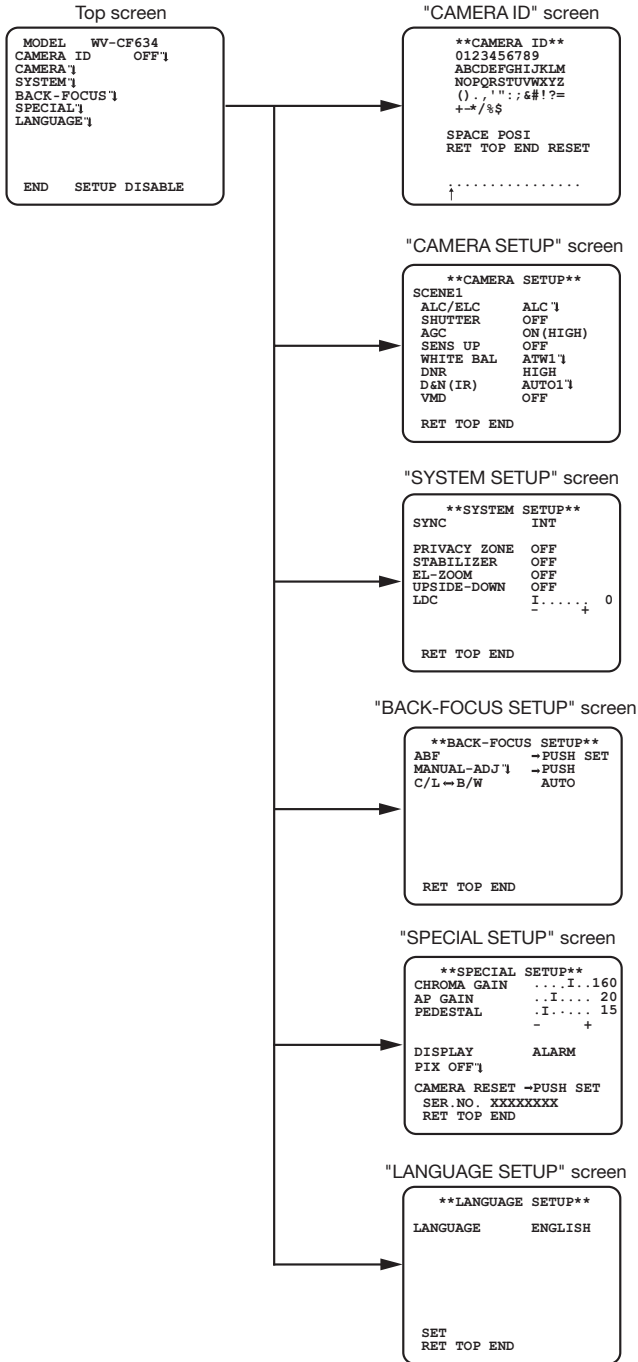

# Screen transition diagram CF614

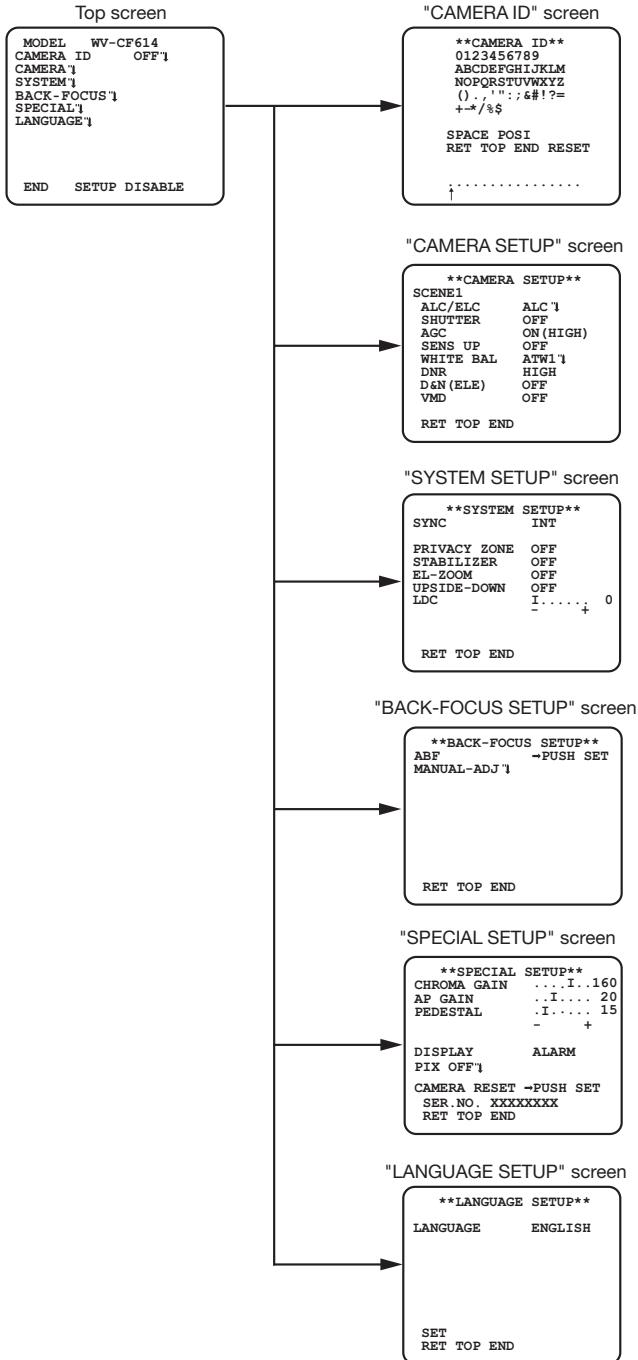

# Screen transition diagram CF374

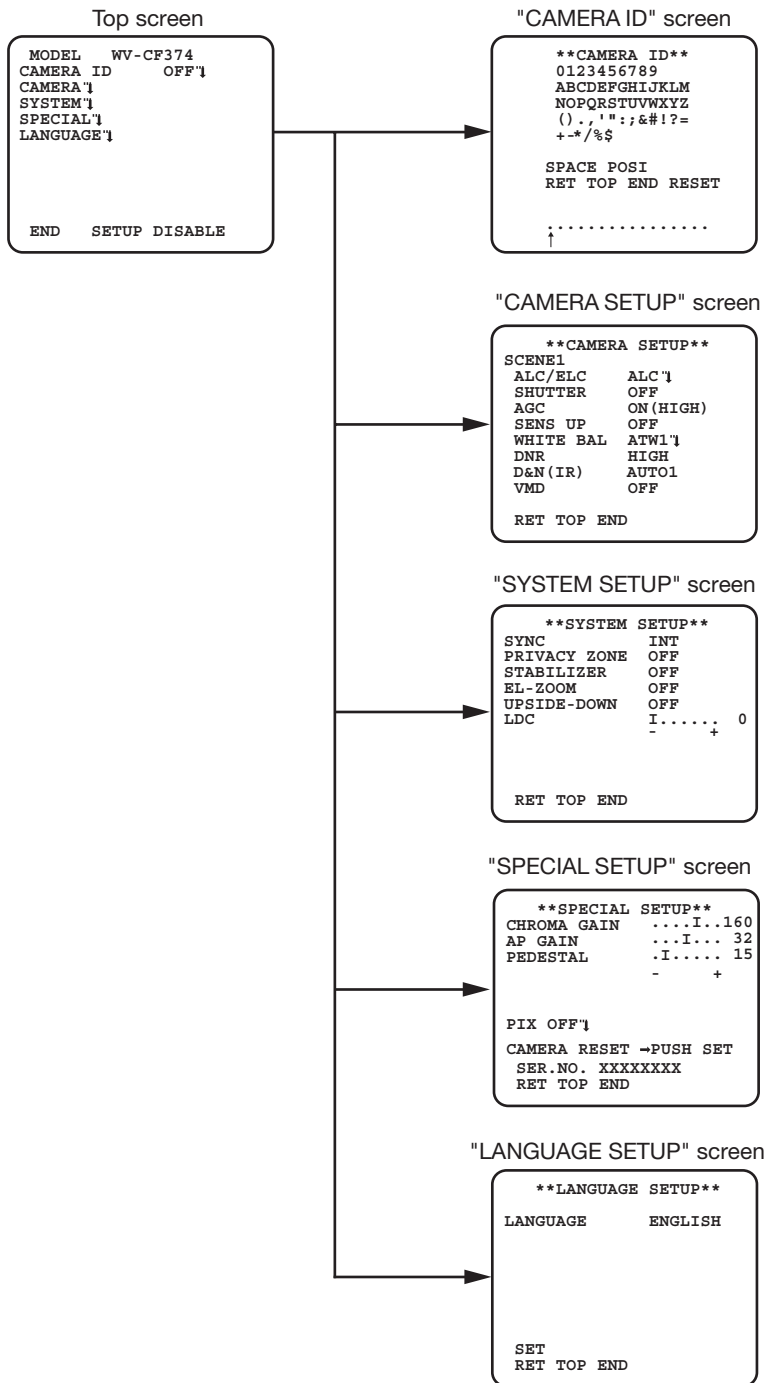

# Screen transition diagram CF354

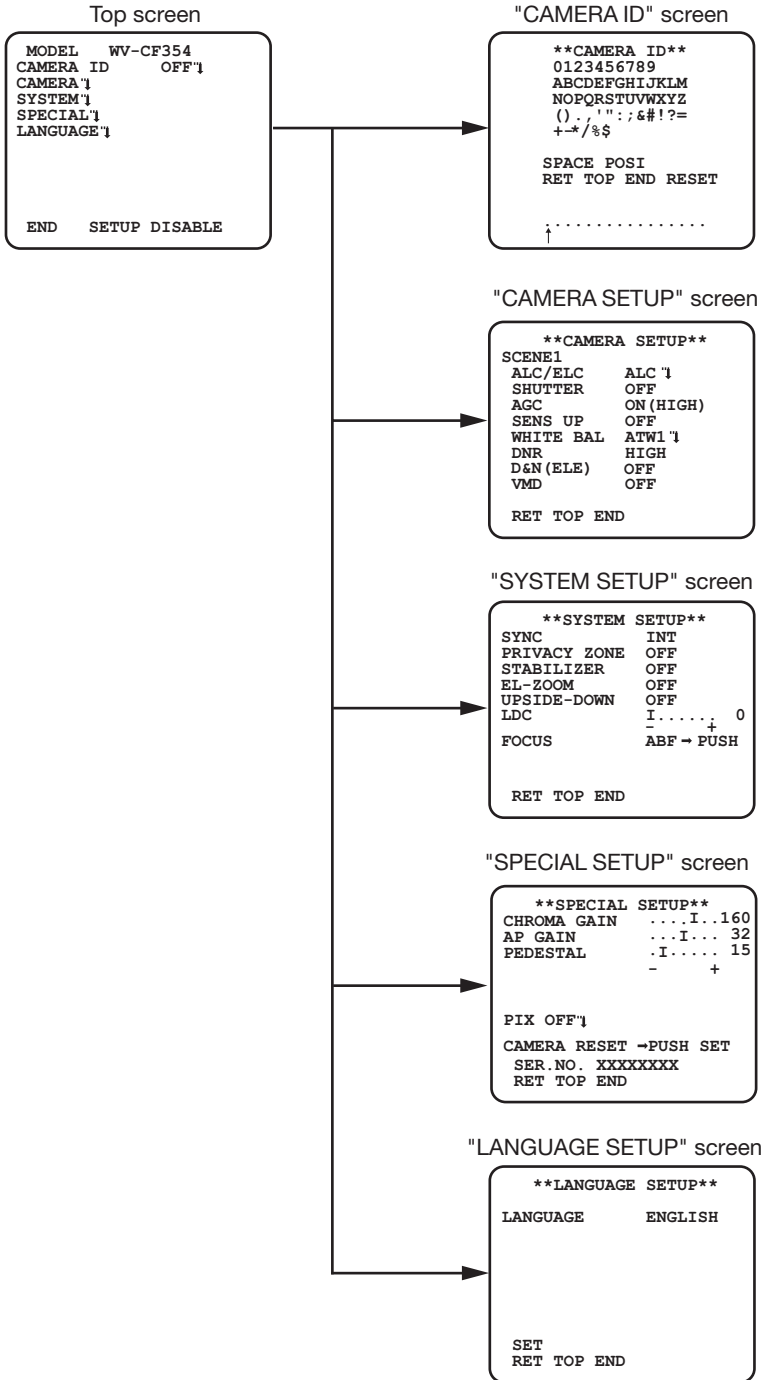

# Screen transition diagram CF344

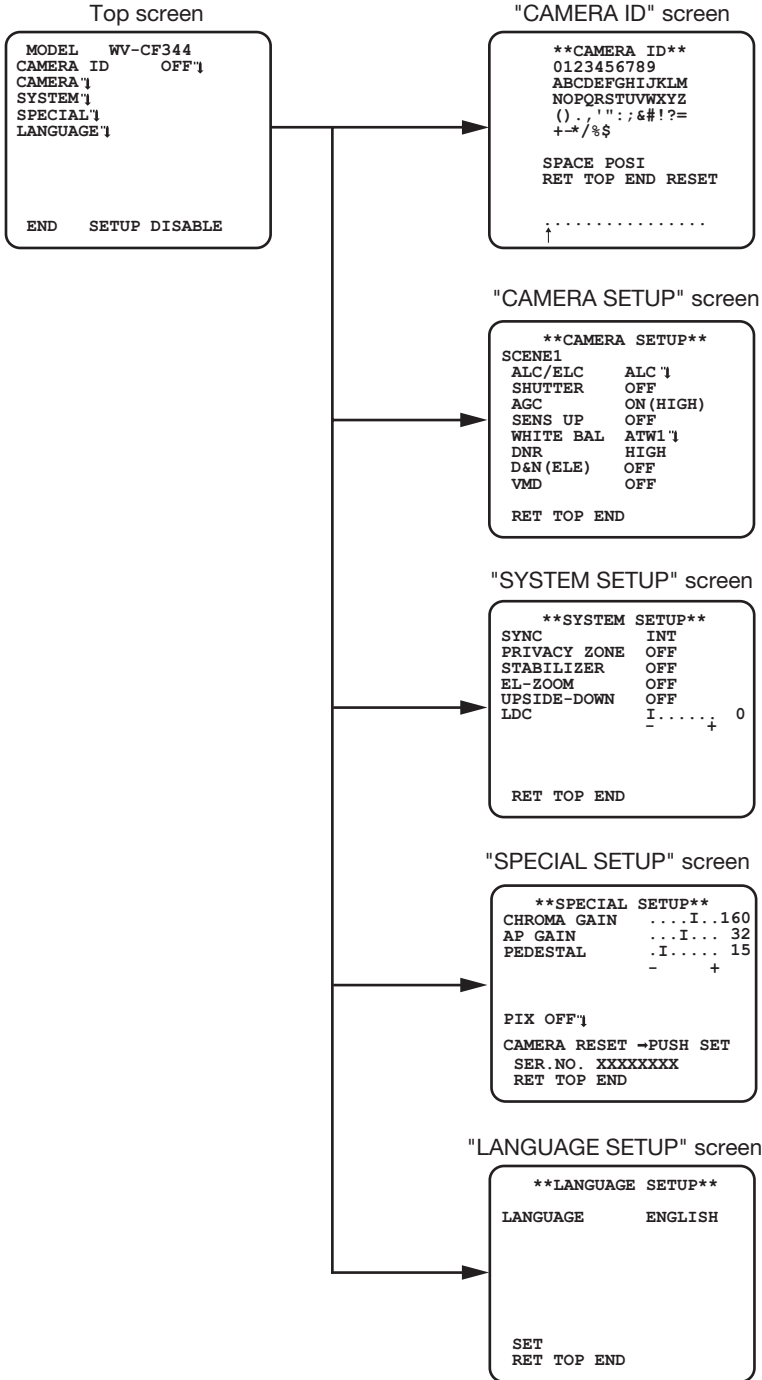

# Troubleshooting















Before asking for repairs, confirm the causes with the following table.

Contact your dealer if a problem cannot be solved even after checking and trying the solution in the table or a problem is not described below.

Symptom	Cause/solution	Reference page
No image displayed	<ul style="list-style-type: none"> <li>Are the power cord and coaxial cable connected appropriately? → Check whether the connection is appropriately established.</li> </ul>	15-16
	<ul style="list-style-type: none"> <li>Is the adjustment monitor connected? → Confirm whether the monitor is connected.</li> </ul>	18
	<ul style="list-style-type: none"> <li>Is the monitor brightness appropriately adjusted, or is the contrast appropriately adjusted? → Check whether the monitor settings are appropriate.</li> </ul>	-
	<ul style="list-style-type: none"> <li>Is the cushioning material in the spherical cover removed? → Confirm whether the cushioning material has been removed.</li> </ul>	-
Blurred image	<ul style="list-style-type: none"> <li>Is the spherical cover dirty or damaged? → Verify the state of the spherical cover.</li> </ul>	-
	<ul style="list-style-type: none"> <li>Is the focus adjusted correctly? → Check if the focus is adjusted correctly.</li> </ul>	20-21
	<ul style="list-style-type: none"> <li>Is the lens of the camera soiled with dirt or dust? → Check whether the lens of the camera is clean.</li> </ul>	-
Black line in image	<ul style="list-style-type: none"> <li>Is the connected system controller set to multiplexed vertical drive (VD2)? → Check whether the connected system controller is set correctly.</li> </ul>	9
Damaged power cord sheathing	<ul style="list-style-type: none"> <li>The power cord or connector is damaged. Continuous use of the damaged cord or connector may cause electric shock or fire. Turn off the power supply immediately and request repair from your dealer.</li> </ul>	-
Heated portion of power line consisting of power cord and connector during use		
The temperature of power cord rises or falls when the power cord is bent or stretched during use		



# Specifications

	WV-CF634E WV-CF374E	WV-CF614E WV-CF354E	WV-CF344E
Power source	24 V AC 50/60 Hz, 12 V DC		
Power consumption	24 V AC: 2.5 W, 12 V DC: 220 mA   24 V AC: 2.1 W, 12 V DC: 180 mA   		
Image sensor	1/3-type interline transfer CCD		
Effective pixels	976 (H)×582 (V)		
Scanning area	4.8 mm (H)×3.6 mm (V)		
Scanning system	2:1 interlace		
Scanning line	625 lines		
Horizontal scanning frequency	15.625 kHz		
Vertical scanning frequency	50.00 Hz		
Synchronization	Internal (INT)		
Horizontal resolution	650 TV lines		
Vertical resolution	400 TV lines		
Video output	1.0 V [p-p] PAL composite video signal 75 Ω		
Signal-to-noise ratio	52 dB (AGC OFF)		
Dynamic range	80 dB typ. (Super Dynamic 6 ON)  		
Minimum illumination	0.08 lx (color mode)		
	0.008 lx (black-and-white mode)	0.05 lx (black-and-white mode)	
Lens	3.6x vari-focal lens		
Focal length	2.8 mm to 10.0 mm		
Aperture ratio	F1.3 (WIDE)to F3.1 (TELE)	F1.3 (WIDE)to F3.0 (TELE)	F1.3 (WIDE)to F3.1 (TELE)
View angle	WIDE (H×V) 100.8°×73.8° TELE (H×V) 27.6°×20.7°	WIDE (H×V) 100.3°×73.4° TELE (H×V) 27.8°×20.9°	WIDE (H×V) 100.3°×73.5° TELE (H×V) 27.6°×20.7°
Adjustable angle range	Pan: +180 ° to -170 ° Tilt: ±90 ° Azimuth: ±100 °		
Ambient operating temperature	-10 °C to +50 °C		
Ambient operating humidity	Less than 90 %		
Dimensions	ø108 mm × 94 mm (H)		
Mass	320 g		
Camera title	English letter, numbers and symbols: up to 16 characters.		
Light control mode setting	ALC/ALC+/ELC		
Super Dynamic	ON/OFF  		
Back light compensation	ON/OFF   		
Auto black stretch (ABS)	ON/OFF   		
Shutter speed	OFF (1/50), 1/120, 1/250, 1/500, 1/1000, 1/2000, 1/4000, 1/10000, 1/120000 (s)		
Auto gain control	ON (HIGH, MID, LOW)/OFF		
Sensitivity up	OFF/AUTO (×2, ×4, ×6, ×10, ×16, ×32) /FIX (×2, ×4, ×6, ×10, ×16, ×32, ×64, ×128, ×256, ×512)		

	WV-CF634E WV-CF374E	WV-CF614E WV-CF354E	WV-CF344E
White balance	ATW1/ATW2/AWC		
Digital noise reduction	LOW/HIGH		
Day&Night (IR)	AUTO1/AUTO2/ON/OFF <small>CF634</small> <small>CF374</small>		
Day&Night (Electric)	AUTO/OFF <small>CF614</small> <small>CF354</small> <small>CF344</small>		
Video motion detection	OFF/MOTION DETECTION /SCENE CHANGE		
Number of scene file	2		
Privacy zone	ON (1)/ON (2)/OFF		
Image stabilizer	ON/OFF		
Electronic zoom	ON (up to 2x)/OFF		
Upside-down	ON/OFF		
Lens distortion correction	0 to 255		
Focus <small>CF354</small>	ABF/MANUAL		
Back-focus setup <small>CF634</small> <small>CF614</small>	ABF/MANUAL		

※ Values of mass and dimensions are approximate. The specification is subject to change without notice.

## Standard accessories

CD-ROM\* ..... 1 pc.

Installation Guide(this book) ..... 1 pc.

\*The CD-ROM contains the operating installations and installation guide (PDF).

The following is used during installation procedures:

Installation template label..... 1 pc.

## Information on Disposal for Users of Waste Electrical & Electronic Equipment (private households)



This symbol on the products and/or accompanying documents means that used electrical and electronic products should not be mixed with general household waste.

For proper treatment, recovery and recycling, please take these products to designated collection points, where they will be accepted on a free of charge basis.

Alternatively, in some countries you may be able to return your products to your local retailer upon the purchase of an equivalent new product.

Disposing of this product correctly will help to save valuable resources and prevent any potential negative effects on human health and the environment which could otherwise arise from inappropriate waste handling. Please contact your local authority for further details of your nearest designated collection point.

Penalties may be applicable for incorrect disposal of this waste, in accordance with national legislation.

## For business users in the European Union

If you wish to discard electrical and electronic equipment, please contact your dealer or supplier for further information.

## Information on Disposal in other Countries outside the European Union

This symbol is only valid in the European Union. If you wish to discard this product, please contact your local authorities or dealer and ask for the correct method of disposal.

## **Panasonic Corporation**

<http://www.panasonic.com>

Panasonic i-PRO Sensing Solutions Co., Ltd.  
Fukuoka, Japan

Authorised Representative in EU:

Panasonic Testing Centre  
Panasonic Marketing Europe GmbH  
Winsbergring 15, 22525 Hamburg, Germany

© Panasonic i-PRO Sensing Solutions Co., Ltd. 2019

sC1211-5109 PGQX1143UA Printed in China