

# Panasonic

## Installation Guide

Color CCTV Camera

Model No.

**WV-CS580/G**

**WV-CS584E**



Before attempting to connect or operate this product,  
please read these instructions carefully and save this manual for future use.

The model number is abbreviated in some descriptions in this manual.

We declare under our sole responsibility that the product to which this declaration relates is in conformity with the standards or other normative documents following the provisions of Directives 2006/95/EC and 2004/108/EC.

Wir erklären in alleiniger Verantwortung, daß das Produkt, auf das sich diese Erklärung bezieht, mit den folgernden Normen oder normativen Dokumenten übereinstimmt. Gemäß den Bestimmungen der Richtlinie 2006/95/EC und 2004/108/EC.

Nous déclarons sous notre propre responsabilité que le produit auquel se réfère la présente déclaration est conforme aux normes spécifiées ou à tout autre document normatif conformément aux dispositions des directives 2006/95/CE et 2004/108/CE.

Nosotros declaramos bajo nuestra única responsabilidad que el producto a que hace referencia esta declaración está conforme con las normas u otros documentos normativos siguiendo las estipulaciones de las directivas 2006/95/CE y 2004/108/CE.

Noi dichiariamo sotto nostra esclusiva responsabilità che il prodotto a cui si riferisce la presente dichiarazione risulta conforme ai seguenti standard o altri documenti normativi conformi alle disposizioni delle direttive 2006/95/CE e 2004/108/CE.

#### WARNING:

- This apparatus must be earthed.
- Apparatus shall be connected to a mains socket outlet with a protective earthing connection.
- The mains plug or an appliance coupler shall remain readily operable.
- To prevent fire or electric shock hazard, do not expose this apparatus to rain or moisture.
- The apparatus should not be exposed to dripping or splashing and that no objects filled with liquids, such as vases, should be placed on the apparatus.
- All work related to the installation of this product should be made by qualified service personnel or system installers.
- For PERMANENTLY CONNECTED APPARATUS provided neither with an all-pole MAINS SWITCH nor an all-all pole circuit breaker, the installation shall be carried out in accordance with all applicable installation rules.
- The connections should comply with local electrical code.
- To prevent injury, this apparatus must be securely attached to the floor/wall/ceiling in accordance with the installation instructions.



#### CAUTION

RISK OF ELECTRIC SHOCK DO NOT OPEN



CAUTION: TO REDUCE THE RISK OF ELECTRIC SHOCK,  
DO NOT REMOVE COVER (OR BACK).  
NO USER-SERVICEABLE PARTS INSIDE.  
REFER SERVICING TO QUALIFIED SERVICE PERSONNEL.

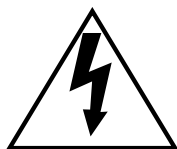

The lightning flash with arrowhead symbol, within an equilateral triangle, is intended to alert the user to the presence of uninsulated "dangerous voltage" within the product's enclosure that may be of sufficient magnitude to constitute a risk of electric shock to persons.



The exclamation point within an equilateral triangle is intended to alert the user to the presence of important operating and maintenance (servicing) instructions in the literature accompanying the appliance.

Turn the power off at the mains to disconnect the main power for all unit.

Wij verklaren als enige aansprakelijke, dat het product waarop deze verklaring betrekking heeft, voldoet aan de volgende normen of andere normatieve documenten, overeenkomstig de bepalingen van Richtlijnen 2006/95/EC en 2004/108/EC.

Vi erklærer os eneansvarlige for, at dette produkt, som denne deklaration omhandler, er i overensstemmelse med standarder eller andre normative dokumenter i følge bestemmelserne i direktivene 2006/95/EC og 2004/108/EC.

Vi deklarerar härmed vårt fulla ansvar för att den produkt till vilken denna deklaration hänvisar är i överensstämmelse med de standarder eller andra normativa dokument som framställs i direktiv nr 2006/95/EC och 2004/108/EC.

Ilmoitamme yksinomaisella vastuullamme, että tuote, jota tämä ilmoitus koskee, noudattaa seuraavia standardeja tai muita ohjeellisia asiakirjoja, jotka noudattavat direktiivien 2006/95/EC ja 2004/108/EC säädöksiä.

Vi erklærer oss alene ansvarlige for at produktet som denne erklæringen gjelder for, er i overensstemmelse med følgende normer eller andre normgivende dokumenter som følger bestemmelsene i direktivene 2006/95/EC og 2004/108/EC.

#### CAUTION:

- An ALL-POLE MAINS SWITCH with a contact separation of at least 3 mm in each pole shall be incorporated in the electrical installation of the building.

#### FOR YOUR SAFETY PLEASE READ THE FOLLOWING TEXT CAREFULLY.

**WARNING: This apparatus must be earthed.**

#### IMPORTANT

The wires in this mains lead are coloured in accordance with the following code.

Green-and-yellow:	Earth
Blue:	Neutral
Brown:	Live

As the colours of the wire in the mains lead of this appliance may not correspond with the coloured markings identifying the terminals in your plug, proceed as follows.

The wire which is coloured **green-and-yellow** must be connected to the terminal in the plug which is marked with the letter **E** or by the earth symbol  $\perp$  or coloured **green** or **green-and-yellow**.

The wire which is coloured **blue** must be connected to the terminal in the plug which is marked with the letter **N** or coloured **black**.

The wire which is coloured **brown** must be connected to the terminal in the plug which is marked with the letter **L** or coloured **red**.

# Contents

Important safety instructions	4
Limitation of liability	5
Disclaimer of warranty	5
Preface	5
Features	6
About the user manuals	6
Trademarks and registered trademarks	6
Precautions	7
Precautions for installation	9
Major operating controls	11
DIP switch settings	12
■ Communication Parameters (DIP Switch 2)	12
■ Unit Number (DIP Switch 1)	13
■ RS485 Communication Parameters (DIP Switch 1)	15
Camera Installation	16
■ Preparing the Camera and Decorative Cover for Side Cable Exit	17
■ Installing the Camera	17
Uninstalling the Camera	19
■ Removing the Decorative Cover	19
■ Uninstalling the Camera	19
Connections	20
Troubleshooting	22
Specifications	26
Standard accessories	27
Optional accessories	27

## Important safety instructions

- 1) Read these instructions.
- 2) Keep these instructions.
- 3) Heed all warnings.
- 4) Follow all instructions.
- 5) Do not use this apparatus near water.
- 6) Clean only with dry cloth.
- 7) Do not block any ventilation openings. Install in accordance with the manufacturer's instructions.
- 8) Do not install near any heat sources such as radiators, heat registers, stoves, or other apparatus (including amplifiers) that produce heat.
- 9) Do not defeat the safety purpose of the polarized or grounding-type plug. A polarized plug has two blades with one wider than the other. A grounding type plug has two blades and a third grounding prong. The wide blade or the third prong are provided for your safety. If the provided plug does not fit into your outlet, consult an electrician for replacement of the obsolete outlet.
- 10) Protect the power cord from being walked on or pinched particularly at plugs, convenience receptacles, and the point where they exit from the apparatus.
- 11) Only use attachments/accessories specified by the manufacturer.
- 12) Use only with the cart, stand, tripod, bracket, or table specified by the manufacturer, or sold with the apparatus. When a cart is used, use caution when moving the cart/apparatus combination to avoid injury from tip-over.



- 13) Unplug this apparatus during lightning storms or when unused for long periods of time.
- 14) Refer all servicing to qualified service personnel. Servicing is required when the apparatus has been damaged in any way, such as power-supply cord or plug is damaged, liquid has been spilled or objects have fallen into the apparatus, the apparatus has been exposed to rain or moisture, does not operate normally, or has been dropped.

## Limitation of liability

THIS PUBLICATION IS PROVIDED "AS IS" WITHOUT WARRANTY OF ANY KIND, EITHER EXPRESS OR IMPLIED, INCLUDING BUT NOT LIMITED TO, THE IMPLIED WARRANTIES OF MERCHANTABILITY, FITNESS FOR ANY PARTICULAR PURPOSE, OR NON-INFRINGEMENT OF THE THIRD PARTY'S RIGHT.

THIS PUBLICATION COULD INCLUDE TECHNICAL INACCURACIES OR TYPOGRAPHICAL ERRORS. CHANGES ARE ADDED TO THE INFORMATION HEREIN, AT ANY TIME, FOR THE IMPROVEMENTS OF THIS PUBLICATION AND/OR THE CORRESPONDING PRODUCT (S).

## Disclaimer of warranty

IN NO EVENT SHALL Panasonic System Networks Co., Ltd. BE LIABLE TO ANY PARTY OR ANY PERSON, EXCEPT FOR REPLACEMENT OR REASONABLE MAINTENANCE OF THE PRODUCT, FOR THE CASES, INCLUDING BUT NOT LIMITED TO BELOW:

- (1) ANY DAMAGE AND LOSS, INCLUDING WITHOUT LIMITATION, DIRECT OR INDIRECT, SPECIAL, CONSEQUENTIAL OR EXEMPLARY, ARISING OUT OF OR RELATING TO THE PRODUCT;
- (2) PERSONAL INJURY OR ANY DAMAGE CAUSED BY INAPPROPRIATE USE OR NEGLIGENT OPERATION OF THE USER;
- (3) UNAUTHORIZED DISASSEMBLE, REPAIR OR MODIFICATION OF THE PRODUCT BY THE USER;
- (4) INCONVENIENCE OR ANY LOSS ARISING WHEN IMAGES ARE NOT DISPLAYED, DUE TO ANY REASON OR CAUSE INCLUDING ANY FAILURE OR PROBLEM OF THE PRODUCT;
- (5) ANY PROBLEM, CONSEQUENTIAL INCONVENIENCE, OR LOSS OR DAMAGE, ARISING OUT OF THE SYSTEM COMBINED BY THE DEVICES OF THIRD PARTY;
- (6) ANY CLAIM OR ACTION FOR DAMAGES, BROUGHT BY ANY PERSON OR ORGANIZATION BEING A PHOTOGENIC SUBJECT, DUE TO VIOLATION OF PRIVACY WITH THE RESULT OF THAT SURVEILLANCE-CAMERA'S PICTURE, INCLUDING SAVED DATA, FOR SOME REASON, BECOMES PUBLIC OR IS USED FOR ANY PURPOSE;
- (7) LOSS OF REGISTERED DATA CAUSED BY ANY FAILURE.

## Preface

This color CCTV camera is a video surveillance device that incorporates a 1/4-type CCD, a 36x zoom lens, preset and pan and tilt capabilities in a dome configuration.

## Features

### Super Dynamic 6 (SUPER-D6)

SUPER-D6 can capture clear images of subjects whose illumination is extremely different.

### New DSP for high sensitivity

A new noise reduction system lowers minimum illuminance to 0.5 lx in the color mode and 0.04 lx in the black-and-white mode.

### Auto night time switching to black-and-white mode

The camera can be configured to switch to the black-and-white mode automatically under low light conditions for clear images, even at night.

### Digital flip

Normally, a camera needs to stop when it points straight down during a tilt operation. With digital flip, however, the camera is able to tilt from 0° to 180° in a single motion. This makes it possible to track subjects passing directly under the camera more smoothly.

#### Digital Flip Operation

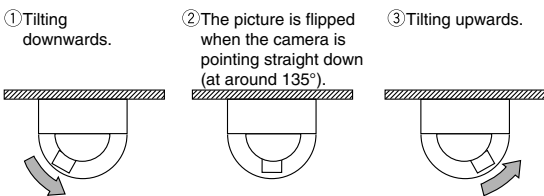

Digital flip is performed only when the system controller joystick is held downwards.

### Privacy zone function

The privacy zone function can mask specific areas of the scene from view.

### Patrol function

The patrol function can store manual camera movement routines for automatic playback. For example, you can set the camera the movements of the people to be monitored, by replaying the stored parameters complicated movements are done automatically.

### Camera position memory

The system can be configured with up to 256 camera positions. A particular camera position can be selected and viewed by entering the applicable preset number on the system controller 10-key pad.

### Motion detection

The system can be configured so any motion on the monitor screen during surveillance causes output of an alarm signal.

## About the user manuals

The operating instructions of the camera consist of 2 sets: this book and operating instructions (PDF). This book explains how to install the camera. Refer to the "Operating Instructions (PDF)" on the provided CD-ROM for descriptions of how to perform the

unit settings. Adobe® Reader® is required to read PDF. When the Adobe® Reader® is not installed on the PC, download the latest Adobe® Reader® from the Adobe web site and install it.

## Trademarks and registered trademarks

Adobe and Reader are either registered trademarks or trademarks of Adobe Systems Incorporated in the United States and/or other countries.

## Precautions

**The following points as well as the contents of "Warning" and "Caution" shall be observed.**

**Refer installation work to the dealer.**

Installation work requires technique and experiences. Otherwise injury, or damage to this product may result. Be sure to consult the dealer.

**Do not insert any foreign objects.**

This could permanently damage this product. Turn the power off immediately and contact qualified service personnel for service.

**Do not attempt to disassemble or modify this product.**

Failure to observe this may cause fire or electric shock. Consult the dealer for the repair or inspections.

**Stop operation immediately when something is wrong with this product.**

When smoke goes up from this product or the smell of smoke comes from this product, continued use will result in fire, injury, or damage to the product. Turn the power off immediately and contact qualified service personnel for service.

**Select an installation area that can support the total weight.**

Selecting an inappropriate installation surface may cause the product to fall down or topple over, resulting in injury. Installation work shall be started after sufficient reinforcement.

**Periodic inspections shall be conducted.**

Rust on the metal parts or screws may cause the product to fall down resulting in injury or accidents. Consult the dealer for the inspections.

**The measures of protection against a fall of this product shall be taken.**

Failure to observe this may cause a drop resulting in injury or accidents.

**Do not touch the main body while this product is panning/tilting.**

Fingers may be caught up in the moving part, and that may result in injury.

**Do not damage the power cable.**

Do not damage, fabricate, twist, stretch, bundle, or forcibly bend the power cable. Do not place heavy objects. Keep away from heat sources. Use of the damaged power cable may cause electric shock, short circuit, or fire. Consult the dealer for repair.

**This product shall be installed in a vibration-free place.**

Failure to observe this may cause screws and bolts to be loosened and consequently to fall resulting in injury.

**Install this product high enough to ensure that people don't hit their heads.**

Failure to observe this may cause a drop resulting in injury or accidents.

**Do not strike or give a strong shock to this product.**

Failure to observe this may cause injury or fire.

**Turn the power off when do wiring of this product.**

Failure to observe this may cause electric shock. In addition, short circuit or wrong wiring may cause fire.

**Do not use this product in an atmosphere of flammable gases.**

Failure to observe this may cause injury by explosion.

**Avoid installing this product in locations where it is subject to damage by salt or corrosive gas.**

Otherwise the mounting fixtures will deteriorate, causing the product to fall down and leading to accidents.

**Use the specified mount bracket.**

Failure to observe this may cause a drop resulting in injury or accidents.

**Do not rub the edges of metal parts with your hand.**

Failure to observe this may cause injury.

**Tighten screws and mounting fixtures to the specified torque.**

Failure to observe this may cause a drop resulting in injury or accidents.

## [Precautions for use]

### **This product has no power switch.**

When turning off the power, turn off a circuit breaker.

### **To keep on using with stable performance**

Parts of this product may deteriorate and it may shorten the lifetime of this product when using in locations subject to high temperatures and high humidity.

Do not expose this product to direct heat sources such as a heater.

### **Handle this product with care.**

Do not drop this product, nor apply shock or vibration to this product.

Failure to observe this may cause trouble.

### **Do not touch the dome cover with your bare hands.**

A dirty dome cover causes deterioration of picture quality.

### **Discoloration on the CCD color filter**

When continuously shooting a bright light source such as a spotlight, the color filter of the CCD may have deteriorated and it may cause discoloration. Even when changing the fixed shooting direction after continuously shooting a spotlight for a certain period, the discoloration may remain.

### **Do not aim this product at strong light sources.**

A light source such as a spot light causes a blooming (light bleeding) or a smear (vertical lines).

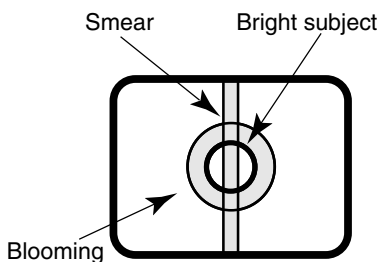

### **Cleaning this product body**

Turn the power off when cleaning this product. Do not use strong abrasive detergent when cleaning this product. Otherwise, it may cause discoloration.

## **About the self-diagnosis function**

When this product malfunctions due to exogenous noise, etc. for 30 seconds or more, the product will automatically reset and will return to normal state. When the product is reset, initialization will be carried out as when the power of the product is turned on. When the product repeatedly resets, exogenous noise level around the product may be high and that may cause malfunction. Contact your dealer for instructions.

### **Lens and pan/tilt head**

If a lens and pan/tilt head are not performed for a long period of time, the grease coating inside these parts may become sticky. That may obstruct the parts from moving. To prevent this, move the lens or pan/tilt head periodically. Or perform position refresh periodically.

### **About the position refresh function**

Noise may be produced or the preset positions may become inaccurate after a long operation.

Execute the "REFRESH" operation periodically, the camera position will be corrected, and it is also recommended to clean the slip ring of the camera. Refer to the operating instructions (PDF) for further information.

### **Consumable parts**

The following are consumables: Replace them in accordance with their lives. Their lives vary depending on use environment and conditions.

Lens unit, slip ring: Approx. 3.7 million operations (Lifetime around 20000 hours is just an indication when using the camera at +35 °C.)

### **Synchronous mode setting**

Image synchronous mode of this camera indicates internal synchronization (INT) only. Set the multiplex vertical driver (VD2) as OFF when the camera is connected to the system controller of the company.



## Precautions for installation

The following points as well as the contents of "Warning" and "Caution" shall be observed.

**Panasonic assumes no responsibility for injuries or property damage resulting from failures arising out of improper installation or operation inconsistent with this documentation.**

**Installation work shall be performed in accordance with the technology standard of the electric installation.**

### Camera Installation Location

- Install the camera on a ceiling (concrete, etc.) at a location that is sufficiently strong to support it.
- When installing the camera on a ceiling of insufficient strength (like a drop ceiling), use the optionally available WV-Q105 Direct Attachment Ceiling Mounting Bracket or the WV-Q126 Embedded Ceiling Mount Bracket.
- For ceiling mounting, use the optionally available WV-Q117 Ceiling Mount Bracket.
- For wall mounting, use the optionally available WV-Q118 Wall Mount Bracket.

**This product is an indoor camera. It is not designed for outdoor use.**

**This product is designed for use in a hanging configuration only. Using it in an upright or inclined configuration can cause malfunction and shorten the life of the camera.**

**Install this product in a horizontal configuration, with the dome pointed downwards.**

**Avoid installing this product in the following locations.**

- Areas directly exposed to rain and water
- Near a swimming pool or other areas where chemicals are used
- Food preparation areas and other locations where there are large amounts of steam vapour and oil, in flammable atmospheres, other special environments
- Areas where radiation, X-rays, strong electric waves, or magnetism is generated
- At sea, in coastal areas, or in areas where corrosive gas is being generated
- Areas outside of the allowable ambient operating temperature range (-10 °C to +50 °C)
- In a motor vehicle, on a boat, or other areas subject to strong vibration (This camera is not designed for use in a vehicle.)
- Near an air conditioner outlet, near a door that opens up to the outdoors, or any other area subjected to temperature extremes (Such conditions can cause clouding and condensation formation on the dome cover.)

**When wiring this product, its cables (power, video output, RS485, alarm in, alarm out) can exit out the side or the top of this product.**

- When using the top cable exit configuration, drill a hole in the ceiling to allow passage of the cables. (See step 3 on page 17.)
- When using the side cable exit configuration, prepare the cut-out in the die cast case and decorative cover. (See "Preparing the Camera and Decorative Cover for Side Cable Exit" on page 17.)

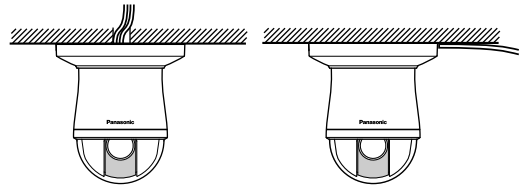

**Avoid installing this product in a place with a high level of noise.**

Installation near an air conditioner, an air cleaner, a vending machine, or the like causes noise.

**Remove the cover film from the dome section of the dome cover after the installation is complete.**

**Be sure to remove this product if it is not in use.**

**Keep this product cable away from the lighting cable.**

Conduct the power distribution work to keep a distance of 1 m or more from the 220 V - 240 V power line. Or conduct the electric conduit work separately. Failure to observe this may cause noise.

### Radio interference

When this product is used near TV/radio antenna, strong electric field or magnetic field (near a motor or a transformer), images may be distorted and noise sound may be produced. In such a case, run the camera cable through specialized steel conduit tubes.

### Locally procure the screws

Screws are not supplied with this product. Prepare the screws according to the material, structure, strength and other factors of the mounting area and the total weight of objects to be mounted.

### Beware of high humidity.

If the camera is installed when humidity is very high, moisture may collect in the camera and cause the dome to become foggy. If the dome becomes foggy, remove it when the humidity is low and eliminate the moisture inside the camera, and then replace the dome.

## Screw tightening

- The screws and bolts must be tightened with an appropriate tightening torque according to the material and strength of the installation area.
- Do not use an impact driver. Failure to observe this may cause overtightening and consequently damage to the screws.
- When a screw is tightened, make the screw at a right angle to the surface. After tightening the screws or bolts, perform visual check to ensure tightening is enough and there is no backlash.

## When the screw is not needed, it should be removed and stored in an appropriate location.

---

### Note:

- If needed, please complete grounding before connecting the power plug. Likewise, the power plug should be unplugged before ending the grounding.
  - The camera does not have a power switch. The camera will turn on automatically when the power cord is attached to the main lead. After starting, the self-cleaning function will be automatically activated, as will the pan, tilt, zoom and focus actions.
- 

## Check before connection

Compatibility of devices are restricted. Before connections, check the ratings and dimensions of the devices to be used.

Contact your dealer for details.

## Important hints to help with the installation

A self-cleaning function is activated (PAN/TILT/ ZOOM/ FOCUS) when this product is turned on.

## Heat radiation

The surface of this product radiates heat. Ventilation holes should be provided when installing the camera in an enclosed ceiling or confined location where heat can build up.

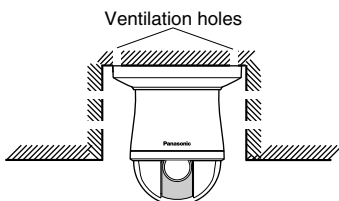

## Major operating controls

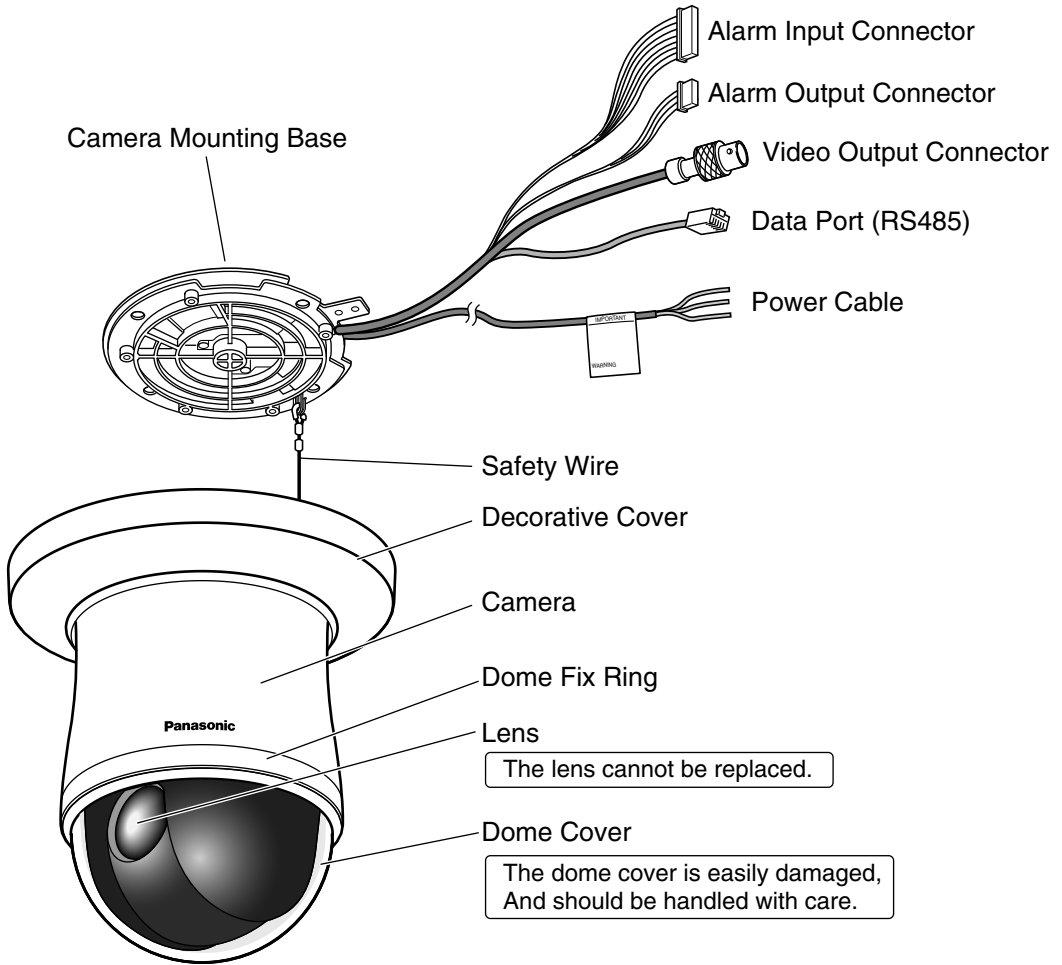

# DIP switch settings

## Important:

- Before setting up the camera for a configuration where the camera's RS485 data port is used for camera control (pan, tilt, etc.) by the system controller, the camera's DIP switches must be configured to specify the unit number and communication parameters.

If DIP switch setting is not performed, the system controller control will not be possible and camera setup will have to be performed again. Be sure to check the DIP switch settings before setting up the camera.

In a configuration where the camera's RS485 data port is used for camera control (pan, tilt, etc.) by the system controller, the camera's DIP switches must be configured to specify the unit number and communication parameters. The camera mounting base needs to be removed to access the DIP switches. See steps 1 and 2 on page 19 for information about how to remove the camera mounting base.

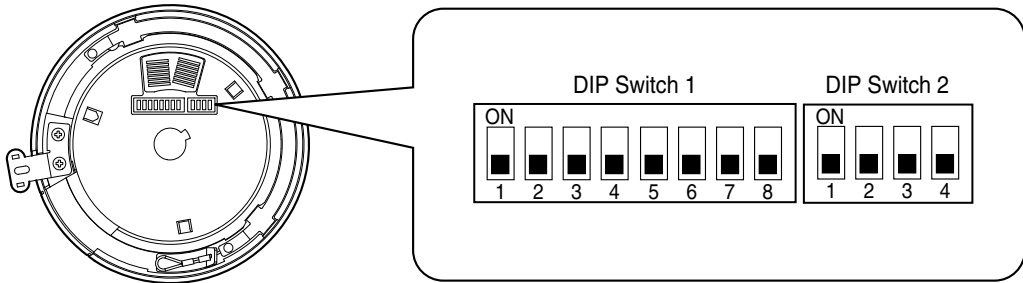

## ■ Communication Parameters (DIP Switch 2)

The factory default settings are all OFF.

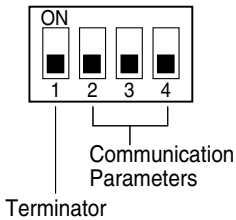

### Switch 1: Terminator (Internal Termination Resistance)

Set to ON in the following situations.

- When 1 camera is connected to this unit
- When 2 or more cameras are connected to this unit that works as a termination

### Switches 2 to 4: Communication Parameters

This setting toggles between 2-line and 4-line communication. Use these switches to select the communication protocol being used.

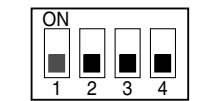

4-line Communication

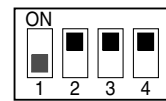



































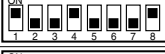
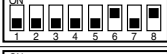
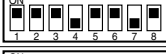



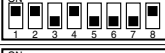
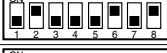



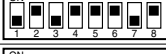





















2-line Communication

## ■ Unit Number (DIP Switch 1)

The factory default settings of these DIP switches are all OFF. (Coaxial Multiplex System)

### Configuration for using Panasonic Protocol

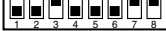
DIP Switch 1	Unit Number	DIP Switch 1	Unit Number	DIP Switch 1	Unit Number
	1 ~ 96 *		23		46
	1		24		47
	2		25		48
	3		26		49
	4		27		50
	5		28		51
	6		29		52
	7		30		53
	8		31		54
	9		32		55
	10		33		56
	11		34		57
	12		35		58
	13		36		59
	14		37		60
	15		38		61
	16		39		62
	17		40		63
	18		41		64
	19		42		65
	20		43		66
	21		44		67
	22		45		68

DIP Switch 1	Unit Number	DIP Switch 1	Unit Number	DIP Switch 1	Unit Number
	69		78		87
	70		79		88
	71		80		89
	72		81		90
	73		82		91
	74		83		92
	75		84		93
	76		85		94
	77		86		95

### Configuration for using Pelco protocol

DIP Switch 1	Unit Number Pelco-P	Unit Number Pelco-D	DIP Switch 1	Unit Number Pelco-P	Unit Number Pelco-D	DIP Switch 1	Unit Number Pelco-P	Unit Number Pelco-D
	1	32-96		12	11		23	22
	2	1		13	12		24	23
	3	2		14	13		25	24
	4	3		15	14		26	25
	5	4		16	15		27	26
	6	5		17	16		28	27
	7	6		18	17		29	28
	8	7		19	18		30	29
	9	8		20	19		31	30
	10	9		21	20		32	31
	11	10		22	21			

### [RS485 SETUP] Menu

```

** RS485 SETUP **
UNIT NUMBER   P1 D32
SUB ADDRESS   ---P
BAUD RATE     19200
DATA BIT      8
PARITY CHECK   NONE
STOP BIT      1
XON/XOFF     NOT USE
WAIT TIME     OFF
ALARM DATA   AUTO2
DELAY TIME    OFF
RET TOP

```

Using a joystick, etc., set the unit number (32 to 96).  
(The illustration shows that the unit number is set to 32.)

---

**Important:**





- When using Pelco protocol, make sure that the system works properly before use. Some functions using Pelco protocol may be restricted when this camera and the apparatuses (commercially available) compatible with Pelco protocol operate together.
- 

**Note:**

- When using the Unit Number 1 to 96 of Panasonic Protocol and using the Unit Number 32 to 96 of Pelco-D protocol, the unit number setting needs to be configured using the RS485 SET UP menu. For details about configuring this setting, refer to the operating instructions (PDF).
  - Turning on power when this setting is selected causes the RS485 SET UP menu to appear during the initialisation routine.
- 

## ■ RS485 Communication Parameters (DIP Switch 1)

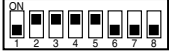
Configuring DIP Switch 1 as shown below resets communication parameters to their factory default settings. You can then change the settings as desired.

DIP Switch 1	Setting Description
	This setting resets communication parameters to the factory default settings.
	BAUD RATE : 19 200 bit/s, DATA BIT : 8 bit, PARITY CHECK : NONE, STOP BIT : 1 bit
	BAUD RATE : 9 600 bit/s, DATA BIT : 8 bit, PARITY CHECK : NONE, STOP BIT : 1 bit
	BAUD RATE : 4 800 bit/s, DATA BIT : 8 bit, PARITY CHECK : NONE, STOP BIT : 1 bit
	BAUD RATE : 2 400 bit/s, DATA BIT : 8 bit, PARITY CHECK : NONE, STOP BIT : 1 bit

Perform the following steps to use this setting.

- (1) Turn off the camera and use DIP Switch 1 to configure RS485 communication parameters as shown above.
- (2) Turn on the camera.  
This applies the setting you configured in step (1).
- (3) Turn off the camera, use DIP Switch 1 to set the unit number (see pages 13 and 14), and then turn the camera back on again.

# Camera Installation

When installing the camera on a wall or a ceiling, please read the important notice below.

**Important:**

- Procure 4 screws (M4) to secure the camera to a wall or a ceiling according to the material of the installation area. In this case, wood screws and nails should not be used. For mounting a camera on a concrete wall, use an anchor bolt (for M4) or an AY plug bolt (M4) for securing. (Recommended tightening torque: 1.6 N·m)
- Required pull-out capacity of a single screw/bolt is 196 N or more.
- If a ceiling board such as plaster board is too weak to support the total weight, the area shall be sufficiently reinforced or the Ceiling Mount Bracket for the camera, WV-Q105 (option), must be used.

The mounting conditions of the camera are described as follows:

Installation place	Applicable mount bracket	Recommended screw	Number of screw	Minimum pull-out strength (per 1 pc.)
Ceiling	(Direct mounting)	M4	4 pcs.	196 N
Ceiling	WV-Q105 (approx. 150 g)	–	–	*1
Ceiling	WV-Q126 (approx. 1200 g)	M4	4 pcs.	*1
Ceiling	WV-Q117 (approx. 720 g)	M4	4 pcs.	*1
Wall	WV-Q118 (approx. 650 g)	M4	4 pcs.	*1

\*1 Make sure that the installed mount bracket can support more than 5 times of the weight of the camera.

**<When using the optional mount bracket WV-Q105>**

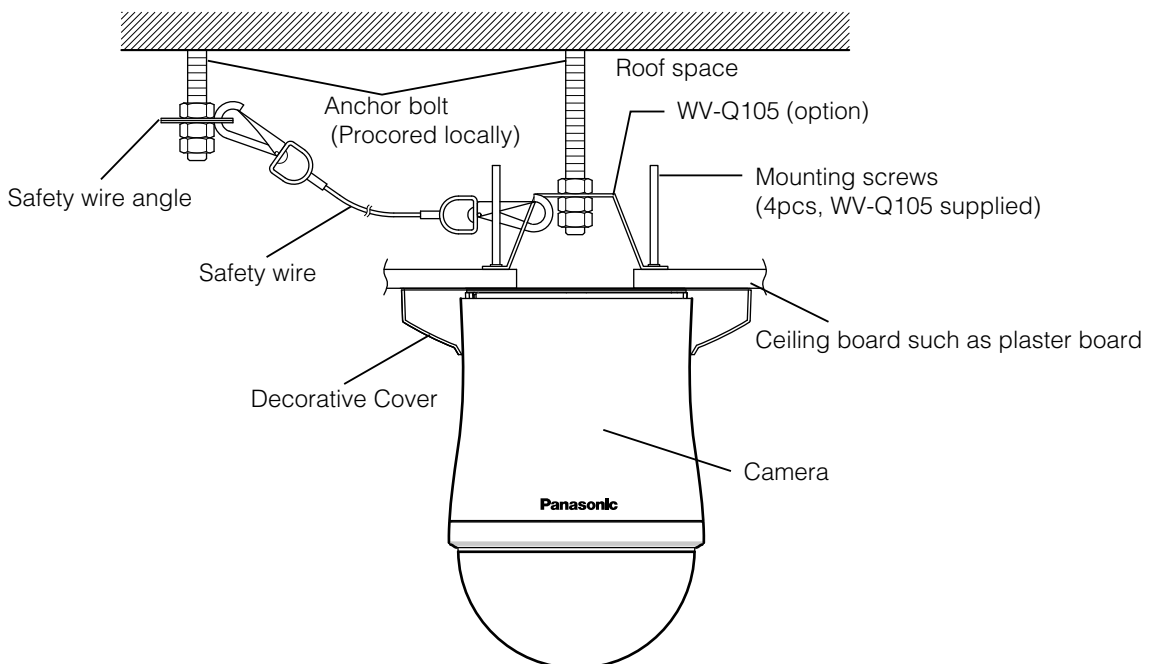



## ■ Preparing the Camera and Decorative Cover for Side Cable Exit

The camera and decorative cover should be prepared as shown below when mounting the camera on a ceiling or wall with its cables (power, video output, RS485, alarm in, alarm out) exiting from the side.

Perform this task when using Ceiling Mount Bracket WV-Q126, or Wall Mount Bracket WV-Q118.

The camera mounting base needs to be removed in order to prepare the camera. See steps 1 and 2 below for information about how to remove the camera mounting base.

- \* Prevent the dome cover from being scratched by placing it on a soft cloth while you are working.

Preparing the Camera Case\*

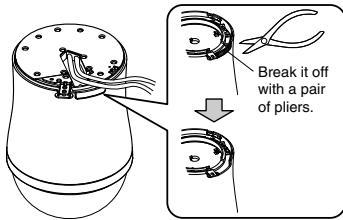

Preparing the Decorative Cover

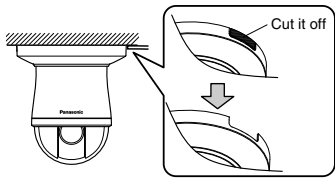

### Important:

- When using Ceiling Mount Bracket WV-Q126 (option), or Wall Mount Bracket WV-Q118 (option), cut only the camera case. Do not use decorative covers on these mount brackets.

## ■ Installing the Camera

- Select an installation location that is strong enough to withstand the total weight of the camera. Installing the camera at a location that is too weak can cause it to fall.
- Remove the dome protective sheet after the installation work is complete.
- If you are using an optional bracket to install the camera, install the bracket in accordance with the instructions that come with it.

1. Remove the fixing screw (M3 × 6) that secures the camera to the camera mounting base. Put the screw in a place where it will not become lost.

### Note:

- If the camera mounting base is hard to be removed, after loosening the screw, press upwards on the camera and then remove it.

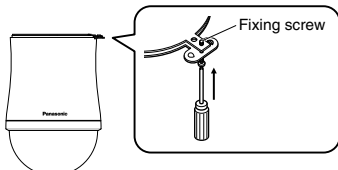

2. Rotate the camera mounting base unit in the direction indicated by the arrow and remove it.

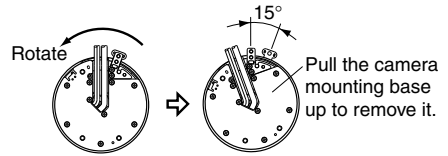

3. Using the camera mounting base as a template, mark the locations of the four mounting holes on the ceiling. If you are using the top cable exit configuration, mark the location of the cable hole on the ceiling and drill the hole.

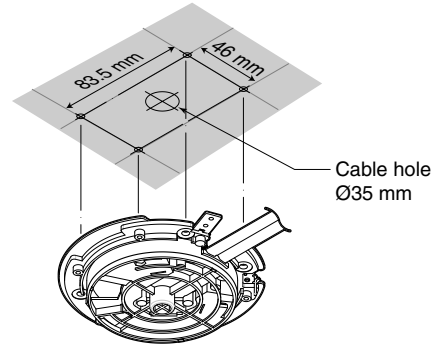

For the direction of the camera mounting base, please refer to the following figure.

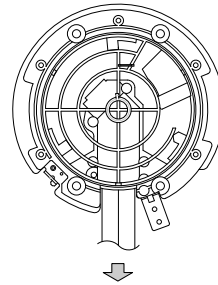

The direction of the front of the camera

4. Affix the camera mounting base onto the ceiling. Use screws (M4) at the locations you marked above to secure the camera mounting base to the ceiling. If you do not plan to install the camera right away, affix the dust protect sheet to the camera mounting base to keep dust off of it.

### Important:

- Screws: locally procured.

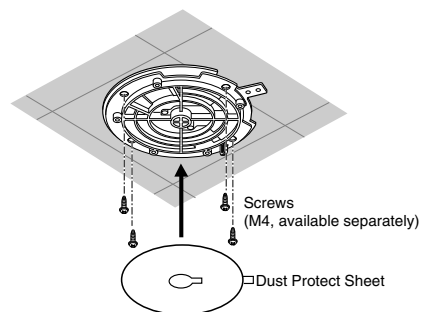

5. Connect the cables.  
Please refer to page 20 for the details of connections.
6. Attach the safety wire for securing the camera to the camera mounting base.  
Pull on the safety wire to make sure its ring is securely connected to the camera mounting base hook.  
If the dust protect sheet that comes with the camera is affixed to the camera mounting base, remove it before performing the above step.

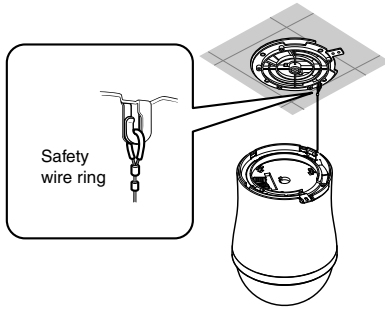

**Note:**

- The safety wire is designed to allow the camera to hang from it. Do not apply force greater than the weight of the camera to the wire.

7. Install the camera onto the camera mounting base.  
Aligning with the camera mounting base, press down on the camera as far as it will go and rotate in the direction indicated by the arrow.

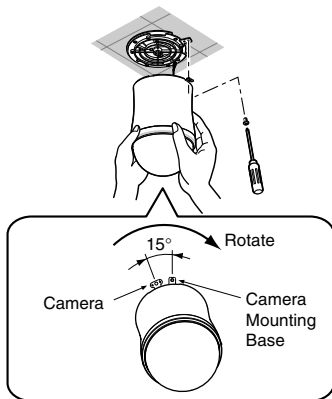

**Note:**

- To prevent damage, please do not rotate while holding the dome cover.

8. Use the fixing screw you removed in step 1 to secure the camera to the camera mounting base.

**Important:**

- Recommended tightening torque: 0.68 N · m.

9. Check the installation.
- Is the camera is level and installed securely?
  - Is the camera free of looseness?
  - Does the fixed part of the camera remain in place when you try to rotate it?

10. Separate the two parts of the decorative cover (comes with camera).  
Press upwards on the decorative cover at the points marked  (indicated by the arrows, in the illustration below) to unhook the two parts from each other.

- \* When removing the decorative cover, the direction to press (➡) is shown on the side of the decorative cover.

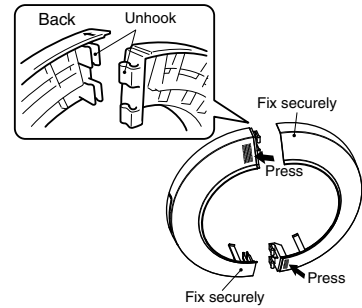

**Caution:**

- Pressing up on the wrong side of the decorative cover can damage it.

11. Put the two pieces of the decorative cover on the left and right side of the camera, and hook them together.

Align the hooks and press the piece indicated by the arrow in the illustration below into the other piece.

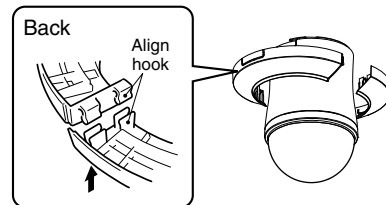

12. Slide the decorative cover up to the ceiling.

- In the case of a top cable exit configuration, slide the decorative cover straight up and press it firmly against the ceiling.
- In the case of a side cable exit configuration, align the cut-out in the decorative cover with the cables as you slide it up, and press it firmly against the ceiling.

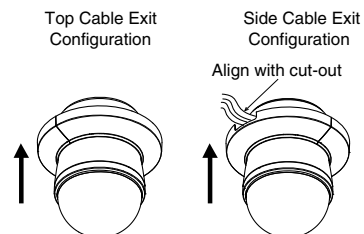

**Caution:**

- Please securely fix the 4 hooks inside the decorative cover onto the camera.

# Uninstalling the Camera



## Caution:

- Make sure you perform the steps below carefully and exactly when uninstalling the camera and decorative cover. Failure to do so creates the risk of damage to the camera.

3. Remove the safety wire from the camera mounting base.

## ■ Removing the Decorative Cover

Note that you need to separate the two parts of the decorative cover in order to remove it.

1. Unhook the two parts of the decorative cover.  
Press upwards on the decorative cover at the points marked  (indicated by the arrows, in the illustration below) to unhook the two parts from each other.  
\* When removing the decorative cover, the direction to press (  ) is shown on the side of the decorative cover.

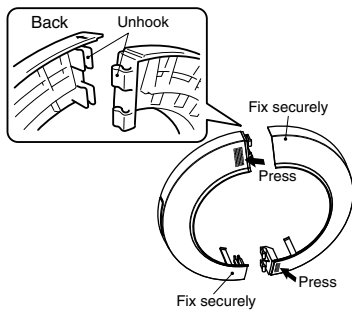

## ■ Uninstalling the Camera

The camera and its base unit are secured by screws. This configuration provides double anchoring, and you should use the following procedure to uninstall the camera.

1. Remove the fixing screw that secures the camera to the camera mounting base.  
Put the screw in a place where it will not become lost.
2. Remove the camera from the camera mounting base.  
Rotate the camera in the direction indicated by the arrow and remove it.

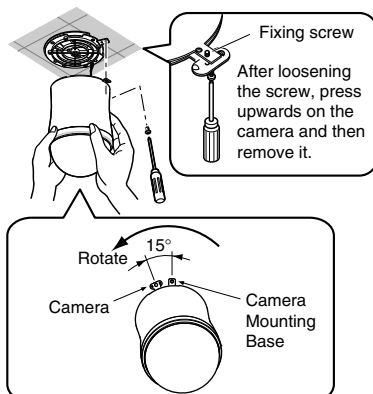

# Connections

## Precautions

- The following connections should be made by qualified service personnel or system installers in accordance with all local codes.
- See the reverse side of the cover page for main lead connection.
- Turn off the power at the fuse box before starting the installation work, or it so could result in fire, electric shock, personal injury, and material damage.

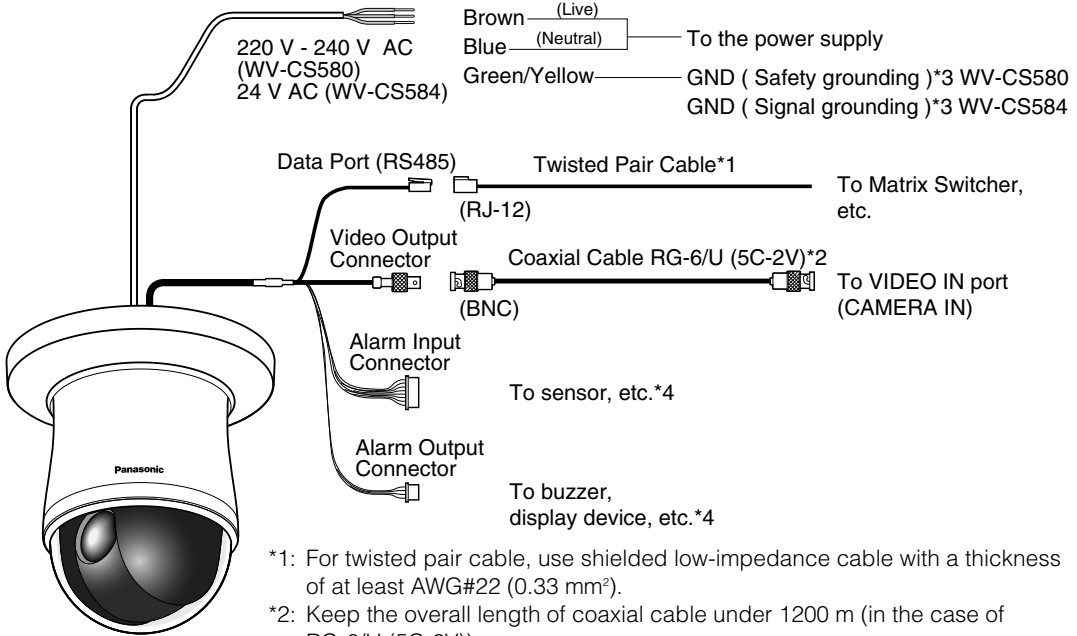

- \*1: For twisted pair cable, use shielded low-impedance cable with a thickness of at least AWG#22 (0.33 mm<sup>2</sup>).
- \*2: Keep the overall length of coaxial cable under 1200 m (in the case of RG-6/U (5C-2V)).
- \*3: Be sure to connect the grounding cable to ground.
- \*4: Since a female cable is not attached, cut off the connector and connect to the twisted pair cable of the same type.

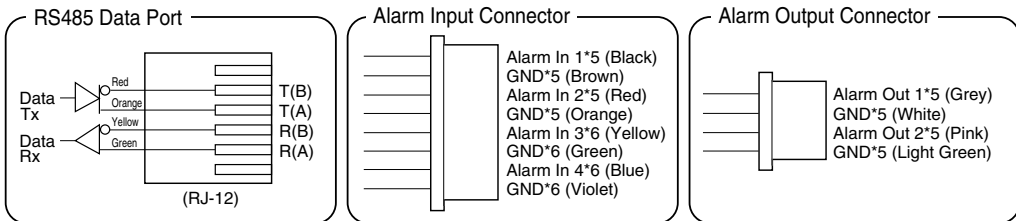

- \*5: The type of twisted pair cable is AWG#28.
- \*6: The type of twisted pair cable is AWG#26.

**Alarm In/Out Ratings**

**Alarm In :** 5 V DC pull-up input. Drive capacity of at least 0.2 mA required.

**OFF :** 4 V to 5 V , or open

**ON :** 1 V DC or less, or short

**Alarm Out :** Open collector output. 16 V DC, maximum drive current: 100 mA

**OFF :** Open

**ON :** 100 mA or less

**Note:**

- Do not turn off camera power within 30 seconds after turning it on. Doing so can cause pan, tilt, zoom, or focus to go out of position.

**• 24 V AC Power Supply Connection**

Recommended wire gauge sizes for 24 V AC line

Copper wire size (AWG)		#24 (0.22mm <sup>2</sup> )	#22 (0.33mm <sup>2</sup> )	#20 (0.52mm <sup>2</sup> )	#18 (0.83mm <sup>2</sup> )
Length of cable (approx.)	(m)	20	30	45	75

**Important:**

- The power supply of 24 V AC shall be insulated against 220 to 240 V AC.

**Note:**

- Can only be connected to 24 V AC power supply.
- When using an alarm input or output connector, please connect directly (there is no dedicated cable in between).

# Troubleshooting

Before requesting service, check the following symptoms to see if you can solve the problem yourself. If the countermeasures described below do not correct the problem, or if the symptoms you are experiencing are not covered here, contact a quality service person or system installer.

Problem	Cause and Recommended Action	Reference Pages
No picture (dark screen)	<ul style="list-style-type: none"> <li>Is the camera connected correctly? Check the operating instructions that come with your system controller.</li> </ul>	—
	<ul style="list-style-type: none"> <li>Is the lens iris closed? Execute the iris reset from the system controller you are using.</li> </ul>	Operating Instructions
	<ul style="list-style-type: none"> <li>Is the camera set up for a fixed shutter speed?</li> </ul>	Operating Instructions
White picture	<ul style="list-style-type: none"> <li>Is the lens iris open?</li> </ul>	Operating Instructions
	<ul style="list-style-type: none"> <li>Is FIX selected for the electronic sensitivity enhancement (SENS UP) setting?</li> </ul>	Operating Instructions
Out of focus picture	<ul style="list-style-type: none"> <li>Is the dome cover or lens of the camera dirty? If so, clean them.</li> </ul>	7
	<ul style="list-style-type: none"> <li>Is MANUAL selected for the auto focus mode?</li> </ul>	Operating Instructions
	<ul style="list-style-type: none"> <li>Is the object one that is not compatible with auto focus? For such objects, focus manually.</li> </ul>	Operating Instructions
Digital noise in the picture	<ul style="list-style-type: none"> <li>The slip ring may be dirty. Do you have the cleaning function turned on?</li> </ul>	Operating Instructions
	<ul style="list-style-type: none"> <li>Is the camera set up correctly?</li> </ul>	9

Problem	Cause and Recommended Action	Reference Pages
<b>Poor picture color</b>	<ul style="list-style-type: none"> <li>• Check the white balance setting.</li> </ul>	<b>Operating Instructions</b>
	<ul style="list-style-type: none"> <li>• Use the special setup menu to adjust picture quality.</li> </ul>	<b>Operating Instructions</b>
	<ul style="list-style-type: none"> <li>• Is the dome cover or lens of the camera dirty? If so, clean them.</li> </ul>	<b>7</b>
<b>Image flicker</b>	<ul style="list-style-type: none"> <li>• If Super Dynamic 6 is turned on, turn it off.</li> </ul>	<b>Operating Instructions</b>
<b>Afterimages in the picture</b>	<ul style="list-style-type: none"> <li>• Check the DNR setting.</li> </ul>	<b>Operating Instructions</b>
<b>Black-and-white picture</b>	<ul style="list-style-type: none"> <li>• The camera has an auto black-and-white switching mode function. Check the setting of this mode.</li> </ul>	<b>Operating Instructions</b>
<b>Frequent switching between the color and the black-and-white modes</b>	<ul style="list-style-type: none"> <li>• Adjust the black-and-white mode switching level, and the duration time setting.</li> </ul>	<b>Operating Instructions</b>
<b>White specks in the picture</b>	<ul style="list-style-type: none"> <li>• Use the PIX OFF function to perform blemish compensation.</li> </ul>	<b>Operating Instructions</b>
<b>Menu does not open.</b>	<ul style="list-style-type: none"> <li>• Is the camera connected correctly? See the operating instructions that come with the system controller you are using.</li> </ul>	<b>—</b>
	<ul style="list-style-type: none"> <li>• Are camera communication settings configured correctly?</li> </ul>	<b>12-15 20</b>

Problem	Cause and Recommended Action	Reference Pages
<p><b>Black line appears in the image</b></p>	<ul style="list-style-type: none"> <li>• Whether or not the connected system controller is set as multiplex vertical driver (VD2)?</li> </ul>	<p>7</p>
<p><b>Menu settings will not change.</b></p>	<ul style="list-style-type: none"> <li>• Is the password lock function turned on?</li> </ul>	<p><b>Operating Instructions</b></p>
<p><b>I forgot the password.</b></p>	<ul style="list-style-type: none"> <li>• Contact a quality service person or system installer.</li> </ul>	<p>—</p>
<p><b>Picture does not switch to black-and-white.</b></p>	<ul style="list-style-type: none"> <li>• Switching is not performed when the ALARM IN 4 setting is BW. Check the setting.</li> </ul>	<p><b>Operating Instructions</b></p>
<p><b>Pan, tilt, zoom, or focus do not work.</b></p>	<ul style="list-style-type: none"> <li>• Is the camera connected correctly? See the operating instructions that come with the system controller you are using.</li> </ul>	<p>—</p>
	<ul style="list-style-type: none"> <li>• The camera has a pan limit function. Check the PAN LIMIT settings.</li> </ul>	<p><b>Operating Instructions</b></p>
	<ul style="list-style-type: none"> <li>• The motor or lens may be worn. Contact a quality service person or system installer.</li> </ul>	<p>—</p>
<p><b>The camera movement modes (OFF, SEQ, SORT, AUTOPAN, PATROL, AUTOTRACK) do not work.</b></p>	<ul style="list-style-type: none"> <li>• Check the self return function.</li> </ul>	<p><b>Operating Instructions</b></p>
	<ul style="list-style-type: none"> <li>• Check the ALARM IN settings.</li> </ul>	<p><b>Operating Instructions</b></p>
	<ul style="list-style-type: none"> <li>• Check the recover time setting of the motion detector.</li> </ul>	<p><b>Operating Instructions</b></p>



Problem	Cause and Recommended Action	Reference Pages
<p>The camera movement modes (OFF, SEQ, SORT, AUTOPAN, PATROL, AUTOTRACK) setting changes.</p>	<ul style="list-style-type: none"> <li>• Check the self return function.</li> </ul>	<p>Operating Instructions</p>
<p>Camera position is different from the preset position setting.</p>	<ul style="list-style-type: none"> <li>• Perform REFRESH from the special setup menu.</li> </ul>	<p>Operating Instructions</p>
<p>Picture is different from the position setting.</p>	<ul style="list-style-type: none"> <li>• Adjust the picture using the preset menu and a scene file.</li> </ul>	<p>Operating Instructions</p>
<p>Upper part of the picture is black when the camera is in a horizontal orientation.</p>	<ul style="list-style-type: none"> <li>• This is caused by the camera's internal cover. It does not indicate malfunction.</li> </ul>	<p>Operating Instructions</p>
<p>Camera suddenly starts to pan by itself.</p>	<ul style="list-style-type: none"> <li>• If the cleaning function is turned on, this is normal does not indicate malfunction. Check the CLEANING settings.</li> </ul>	<p>Operating Instructions</p>
	<ul style="list-style-type: none"> <li>• If the cleaning function is not turned on, this symptom could be due to noise.</li> </ul>	<p>7, 9</p>

● Periodically check the power cord.

<p>Power cord sheathing is damaged.</p>	<ul style="list-style-type: none"> <li>• The power cord is damaged. Continued use creates the risk of electric shock and fire. Immediately unplug the power plug and contact a qualified service person or system installer for servicing.</li> </ul>
<p>Power cord becomes hot during operation.</p>	
<p>Power cord becomes warm or hot when it is bent or stretched during use.</p>	

# Specifications

## ● General

	WV-CS580	WV-CS584
Power Requirements	220 V - 240 V AC, 50 Hz	24 V AC, 50 Hz
Power Consumption	4.6 W	4.3 W
Pick-up Device	1/4-type interline transfer CCD	
Effective Pixels	976 (H) × 582 (V)	
Scanning Area	3.66 mm (H) × 2.73 mm (V)	
Signal	PAL	
Synchronization	Internal (INT)	
Scanning	2:1 interlace	
Scanning Frequencies	Horizontal: 15.625 kHz, Vertical: 50.00 Hz	
Video Output	VBS: 1.0 V [p-p]/75 Ω (BNC plug)	
Resolution (Center)	Horizontal: 650 TV lines typ. (Center) Vertical : 400 TV lines minimum (Center)	
Minimum Illumination	0.5 lx (color mode) 0.04 lx (black-and-white mode) When using smoke dome cover (option): 0.9 lx (color mode) 0.08 lx (black-and-white mode) SENS UP: OFF; AGC: HIGH	
Dynamic Range	54 dB typ. (SUPER-D6: ON)	
S/N Ratio	52 dB minimum (AGC: OFF)	
Ambient Operating Temperature	-10 °C to +50 °C; Humidity 90 % max. (non-condensation)	
Dimensions	185 mm (D) × 202 mm (H) (including Decorative Cover)	
Mass	Approx. 1.7 kg (including Decorative Cover)	
Finish	Camera: ABS + PC resin, coated (Paint color: Fine Silver) Dome: Clear acrylic resin	

## ● Pan and Tilt

Panning Range	360° endless
Panning Modes	Manual, auto, manual position, sequential position
Panning Speed	Manual: Approx. 0.065 °/s to 120 °/s 8 steps, 16 steps, 64 steps Preset: Approx. 400 °/s
Tilting Range	-5° to 185° (horizontal - vertical - horizontal)
Tilting Modes	Manual, manual position, sequential position
Tilting Speed*1	Manual: Approx. 0.065 °/s to 120 °/s 8 steps, 16 steps, 64 steps Preset: Approx. 400 °/s

\*1 Actual speed depends on type of controller being used.

## ● Lens

Zoom Ratio	36x (Approx. 720x with digital zoom)
Focal Length	3.3 mm to 119 mm
Maximum Aperture Ratio	1:1.4 (WIDE) to 4.2 (TELE)
Object Distance	1.8 m
Iris Range	F1.4 to 22, Close
Angular Field of View	Horizontal: 1.7° (TELE) to 60.2° (WIDE) Vertical: 1.3° (TELE) to 46.0° (WIDE)

## ● Main Functions

Controller Interface	Coaxial Multiplex System, RS485
Control Functions	Pan and tilt, zoom and focus, 256 preset positions, home position, patrol
AGC	ON (LOW), ON (MID), ON (HIGH), OFF
Title (ID)	ON, OFF (Preset ID, camera ID, area title: 16 alphanumeric characters)
Zoom Speed	around 6.0 seconds (TELE to WIDE) in manual mode
Zoom Limit	1x to 720x (Over 36x is digital zoom)
Password Lock	All menus
Auto Focus	MANUAL/AUTO (PAN, TILT, ZOOM linked)
Iris	ALC (Adjustable OPEN/CLOSE output target level)/MANUAL
Shutter	OFF (1/50), AUTO, 1/120, 1/250, 1/500, 1/1000, 1/2000, 1/4000, 1/10000
Electronic Sensitivity Enhancement	32X max. AUTO, 512X max. FIX
Auto Mode	OFF, SEQ, SORT, AUTOPAN, PATROL, AUTOTRACK
Auto Pan Key	SEQ, SORT, AUTOPAN, PATROL, AUTOTRACK
Digital Flip	ON/OFF
SUPER-D6	ON/OFF
VMD	OFF/MOTION DET/SCENE CHANGE
Alarm Input/Output	4 inputs (ALARM IN 1 to ALARM IN 4) 2 outputs (ALARM/AUX1, BW/AUX2)
Black-and-white Mode Switching	AUTO/ON/OFF
Privacy Zone	ON/OFF (8 zone settings)
Patrol	STOP/PLAY/LEARN
Cleaning	ON/OFF
Image Hold	ON/OFF
Auto Image Stabilizer	ON/OFF
Scene Select Setting	INDOOR (L) /INDOOR (H) /OUTDOOR (L) /OUTDOOR (H)
Language Setting	Japanese, English, German, French, Italian, Spanish, Russian, Chinese

\* Weight and dimensions indicated are approximate.

## Standard accessories

CD-ROM* . . . . .	1 pc.
Installation Guide (this book) . . . . .	1 pc.

\*The CD-ROM contains the operating instructions (PDF).

The following parts are used during installation procedures.

Decorative Cover . . . . .	1 pc.
Dust Protect Sheet . . . . .	1 pc.

## Optional accessories

Ceiling Mount Bracket	WV-Q105
Ceiling Mount Bracket	WV-Q126
Ceiling Mount Bracket	WV-Q117
Wall Mount Bracket	WV-Q118
Dome Cover (approx. 50% transparency, smoked type)	WV-CS4S

## **Information on Disposal for Users of Waste Electrical & Electronic Equipment (private households)**

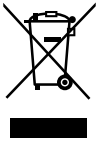

This symbol on the products and/or accompanying documents means that used electrical and electronic products should not be mixed with general household waste.

For proper treatment, recovery and recycling, please take these products to designated collection points, where they will be accepted on a free of charge basis. Alternatively, in some countries you may be able to return your products to your local retailer upon the purchase of an equivalent new product.

Disposing of this product correctly will help to save valuable resources and prevent any potential negative effects on human health and the environment which could otherwise arise from inappropriate waste handling. Please contact your local authority for further details of your nearest designated collection point. Penalties may be applicable for incorrect disposal of this waste, in accordance with national legislation.

### **For business users in the European Union**

If you wish to discard electrical and electronic equipment, please contact your dealer or supplier for further information.

### **Information on Disposal in other Countries outside the European Union**

This symbol is only valid in the European Union.

If you wish to discard this product, please contact your local authorities or dealer and ask for the correct method of disposal.







**Panasonic Corporation**

<http://panasonic.net>

Importer's name and address to follow EU rules:

Panasonic Testing Centre  
Panasonic Marketing Europe GmbH  
Winsbergring 15, 22525 Hamburg F.R.Germany