

i-PRO NVR

CGI Command Interface

WJ-NX400 Series/WJ-NX300 Series /
WJ-NX200 Series /WJ-NX100 Series /
WJ-NU300 Series /WJ-NU301 Series /
WJ-NU201 Series /WJ-NU101 Series

Version 1.0R1

Dec.15, 2022

1. OVERVIEW	5
1.1. TARGET MODELS.....	5
1.2. COMPRESSION METHODS AND PROTOCOLS	5
1.3. BASIC PERFORMANCE	6
1.4. BASIC FUNCTIONS	7
1.5. DISCLAIMER	8
2. LIVE STREAMING.....	9
2.1. LIVE H.264 / H.265 WITH RTP	9
2.1.1. <i>Control sequence for Live streaming with RTP.....</i>	<i>9</i>
2.1.1.1. Live H.264/H.265/Audio	9
2.1.2. <i>Command format.....</i>	<i>10</i>
2.1.2.1. Recorder Control command (Setup Live).....	10
2.1.2.2. Start/Stop command for Live streaming.....	10
2.2. LIVE H.264 / H.265 WITH HTTP/HTTPS.....	11
2.2.1. <i>Control sequence for Live streaming with HTTP/HTTPS.....</i>	<i>11</i>
2.2.1.1. Live H.264/H.265/Audio	11
2.2.2. <i>Command format.....</i>	<i>12</i>
2.2.2.1. Recorder Control command (Setup Live).....	12
2.2.2.2. Start/Stop command for Live streaming.....	12
2.3. DATA FORMAT	13
2.3.1. <i>Live H.264 with RTP.....</i>	<i>13</i>
2.3.2. <i>Live H.265 with RTP.....</i>	<i>14</i>
2.3.3. <i>Live H.264 with HTTP/HTTPS</i>	<i>15</i>
2.3.4. <i>Live H.265 with HTTP/HTTPS</i>	<i>15</i>
2.3.5. <i>Live Audio with RTP.....</i>	<i>16</i>
2.3.6. <i>Live Audio with HTTP/HTTPS.....</i>	<i>17</i>
3. PLAYBACK.....	18
3.1. CONTROL SEQUENCE FOR PLAYBACK	18
3.1.1. <i>Playback start.....</i>	<i>18</i>
3.1.2. <i>Reverse</i>	<i>19</i>
3.1.3. <i>Pause</i>	<i>20</i>
3.1.4. <i>Next image / Previous image.....</i>	<i>21</i>
3.1.5. <i>Playback by specifying time and date</i>	<i>22</i>

3.1.6.	<i>Fast forward</i>	23
3.1.7.	<i>Playback stop</i>	24
3.2.	COMMAND FORMAT	25
3.2.1.	<i>Playback Video Request command</i>	25
3.2.2.	<i>Playback Audio Request command</i>	25
3.2.3.	<i>Recorder Control command (Camera channel to playback)</i>	26
3.2.4.	<i>Recorder Control command (Playback start)</i>	26
3.2.5.	<i>Recorder Control command (Reverse playback start)</i>	27
3.2.6.	<i>Recorder Control command (Pause)</i>	28
3.2.7.	<i>Recorder Control command (Next image / Previous image)</i>	29
3.2.8.	<i>Recorder Control command (Playback by specifying time and date)</i>	30
3.2.9.	<i>Recorder Control command (Fast forward / Fast reverse)</i>	31
3.2.10.	<i>Recorder Control command (Playback stop)</i>	32
3.3.	DATA FORMAT	33
3.3.1.	<i>Playback video</i>	33
3.3.1.1.	Data format for H.264	34
3.3.1.2.	Data format for H.265	36
3.3.2.	<i>Playback audio</i>	38
3.3.2.1.	Data format for G.711 / G.726	38
3.3.2.2.	Data format for AAC-LC	39
4.	4. OTHER SEQUENCES / COMMANDS	41
4.1.	UID ISSUANCE (LOGIN) / DESTRUCTION (LOGOUT)	41
4.1.1.	<i>Sequence / Command for UID Issuance (Login)</i>	41
4.1.2.	<i>Sequence / Command for UID Destruction (Logout)</i>	42
4.2.	KEEP ALIVE	42
5.	ADDITIONAL INFORMATION	43
5.1.	RECORDER INFORMATION ID	43
5.1.1.	<i>ID List</i>	43
5.1.2.	<i>Data structure</i>	44
6.	RECORDER INFORMATION	50
6.1.	LOG INFORMATION	50
6.1.1.	<i>Get Error Log-list</i>	50
6.2.	HDD INFORMATION	51
6.2.1.	<i>Get HDD capacity / Remain capacity / Recording period</i>	51

Revision

Version	Date	Note
1.0R1	Dec.15, 2022	First Edition

With regard to the contents of this document.

- Unauthorized reprinting of part or the whole of the contents of this document is strictly forbidden.
- i-PRO Co., Ltd. reserves the right, at its discretion, to change, modify, add, or remove portions of the contents of this document at any time.

1. Overview

This document is the command interface specification for i-PRO Network Disk Recorder (hereinafter referred to as “NVR”).

1.1. Target models

MODEL 1

WJ-NX400 series, WJ-NX300 series, WJ-NX200 series, WJ-NX100 series
Firmware Version v5.10 or later

MODEL 2

WJ-NU300 series, WJ-NU301 series, WJ-NU201 series, WJ-NU101 series
Firmware Version v1.00 or later

1.2. Compression methods and protocols

Live streaming H.264/H.265/Audio

- CGI control RTP unicast
- CGI control RTP over HTTP/HTTPS unicast

Playback streaming H.264/H.265/Audio

- CGI control HTTP/HTTPS unicast

The target device supports HTTP and HTTPS. For information on switching between HTTP and HTTPS and obtaining the TSL version and root certificate, refer to the instruction manual of the target device.

The supported compression methods (Video/Audio) may differ depending on the target device. For details, refer to the instruction manual of the equipment.

Target model	Video	Audio	HTTP/HTTPS
MODEL 1	H.264/H.265	AAC-LC, G.711, G.726	HTTPS, HTTP or HTTPS *Default(HTTP or HTTPS)
MODEL 2	H.264/H.265	AAC-LC, G.711	HTTPS, HTTP or HTTPS *Default(HTTPS)

* This document does not describe JPEG.

1.3. Basic performance

- Some commands require a UID. UID lifetime is 90 seconds. After obtaining the UID, send the command with the UID before the lifetime expires. Sending a command with a UID reset its lifetime to 90 seconds.
- Up to 16 UIDs can be issued at the same time. If the UID limit is exceeded, the UID with lower priority or first issued UIDs will be invalid.
- Up to 16 live streaming can be distributed using the same UID, but two or more streaming with the same camera number cannot be distributed using the same UID. If you need two or more live streaming with the same camera number, use a different UID.
- Up to 16 playback streaming can be distributed using the same UID, but two or more playback with the same camera number cannot be distributed using the same UID. If you need two or more playback streaming with the same camera number, use a different UID.
- Excessive access may degrade product performance. Send commands at intervals (at least 3 seconds) so as not to affect the performance of the product.
- Excessive streaming or playback may degrade product performance. Therefore, perform streaming or playback so as not to affect the product performance.
- Please refer to the product information such as the instruction manual of the target device for the maximum number of streaming.

1.4. Basic functions

This is the chapter number that explains the basic functions of live streaming and Playback Control.

Functions	Chapters
Login/Logout	
Obtaining a User ID(UID)	4.1
Live streaming	
Generating live video streams (RTP)	2.1, 2.3.1, 2.3.2, 2.3.5, 4.1, 4.2
Generating live video streams (HTTP/HTTPS)	2.2, 2.3.3, 2.3.4, 2.3.6, 4.1, 4.2
Playback streaming (HTTP/HTTPS)	
Starting/Stopping Playback	3.1.1, 3.1.7, 3.2.1, 3.2.2, 3.2.3, 3.2.4, 3.2.10, 3.3.1, 3.3.2, 4.1, 4.2
Starting playback specifying date and time	3.1.5, 3.2.1, 3.2.2, 3.2.3, 3.2.8, 3.3.1, 3.3.2, 4.1, 4.2
Playback pause / Next image / Previous image	3.1.3, 3.1.4, 3.2.1, 3.2.2, 3.2.3, 3.2.6, 3.2.7, 3.3.1, 3.3.2, 4.1, 4.2

1.5. Disclaimer

- This document provides a command interface for the network disk recorder manufactured by i-PRO Corporation. The usage examples described such as sequences are intended to describe usage methods, and are not created for the purpose of actual surveillance system.
- In not event shall i-PRO Co., Ltd. be liable to any party or any person, for the cases, including but not limited to below;
 - [1] Any damage and loss, including without limitation, direct or indirect, special, sequential or exemplary, arising out of or relating to this specification;
 - [2] Personal injury or any damage caused by inappropriate use or neglect operation of the user;
 - [3] Any problems, consequential inconvenience, or loss or damage, arising out of the usage in a method not described in this specification;
 - [4] Any claim or action for damages, brought by any person or organization being a photogenic subject, due to violation of privacy with the result of that surveillance camera's picture, including saved data, for some reason, becomes public or is used for the purpose other than surveillance;
 - [5] Any claim or action for damages due to leakage of video data, audio data, authentication information (user name, password) or any information by a third party with malicious intent such as unauthorized access from the network.

2. Live streaming

2.1. Live H.264 / H.265 with RTP

2.1.1. Control sequence for Live streaming with RTP

2.1.1.1. Live H.264/H.265/Audio

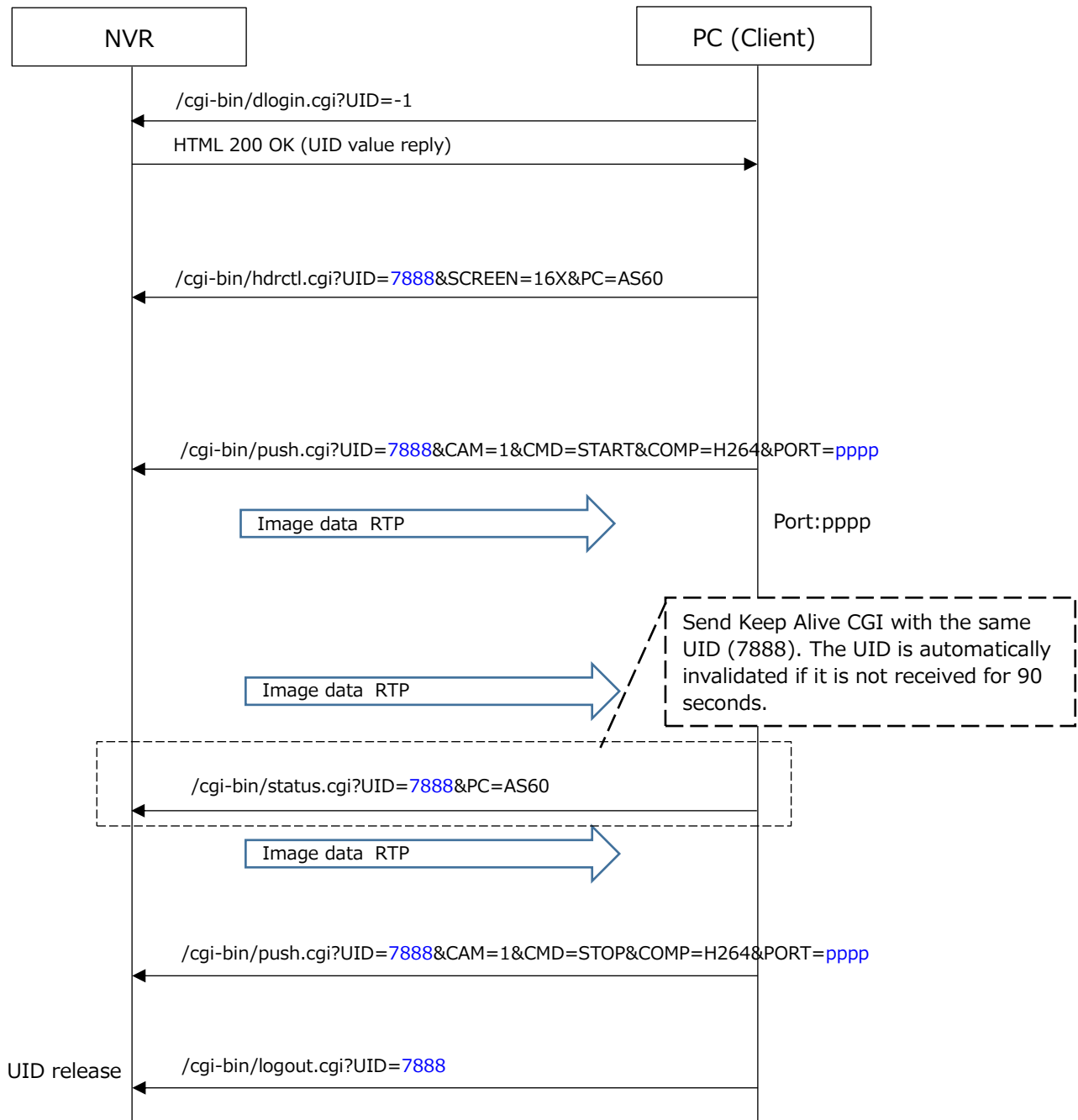

2.1.2. Command format

2.1.2.1. Recorder Control command (Setup Live)

[URL]

/cgi-bin/hdrctl.cgi?UID=<value>&SCREEN=<value>&PC=AS60

[Method] GET

Parameter name	Value	Comments
UID	(Numeric)	Issued User ID
SCREEN	16X	Fixed value
PC	AS60	Fixed value

2.1.2.2. Start/Stop command for Live streaming

[URL]

/cgi-bin/push.cgi?UID=<value>&CAM=<value>&CMD=<value>&COMP=<value>&PORT=<value>

[Method] GET

Parameter name	Value	Comments
UID	(Numeric)	Issued User ID
CAM	(Numeric)	Camera number *Camera number registered in the NVR.
CMD	START STOP	Command START: Start live streaming STOP: Stop live streaming
COMP	H264 H265 AUDIO	Data format H264: H.264 video H265: H265 video AUDIO: Audio *Audio-only stream transmission is not available. Send a command with video parameter before sending a command with audio parameter.
PORT	(Numeric)	Receiving port number

2.2. Live H.264 / H.265 with HTTP/HTTPS

2.2.1. Control sequence for Live streaming with HTTP/HTTPS

2.2.1.1. Live H.264/H.265/Audio

Example HTTP streaming

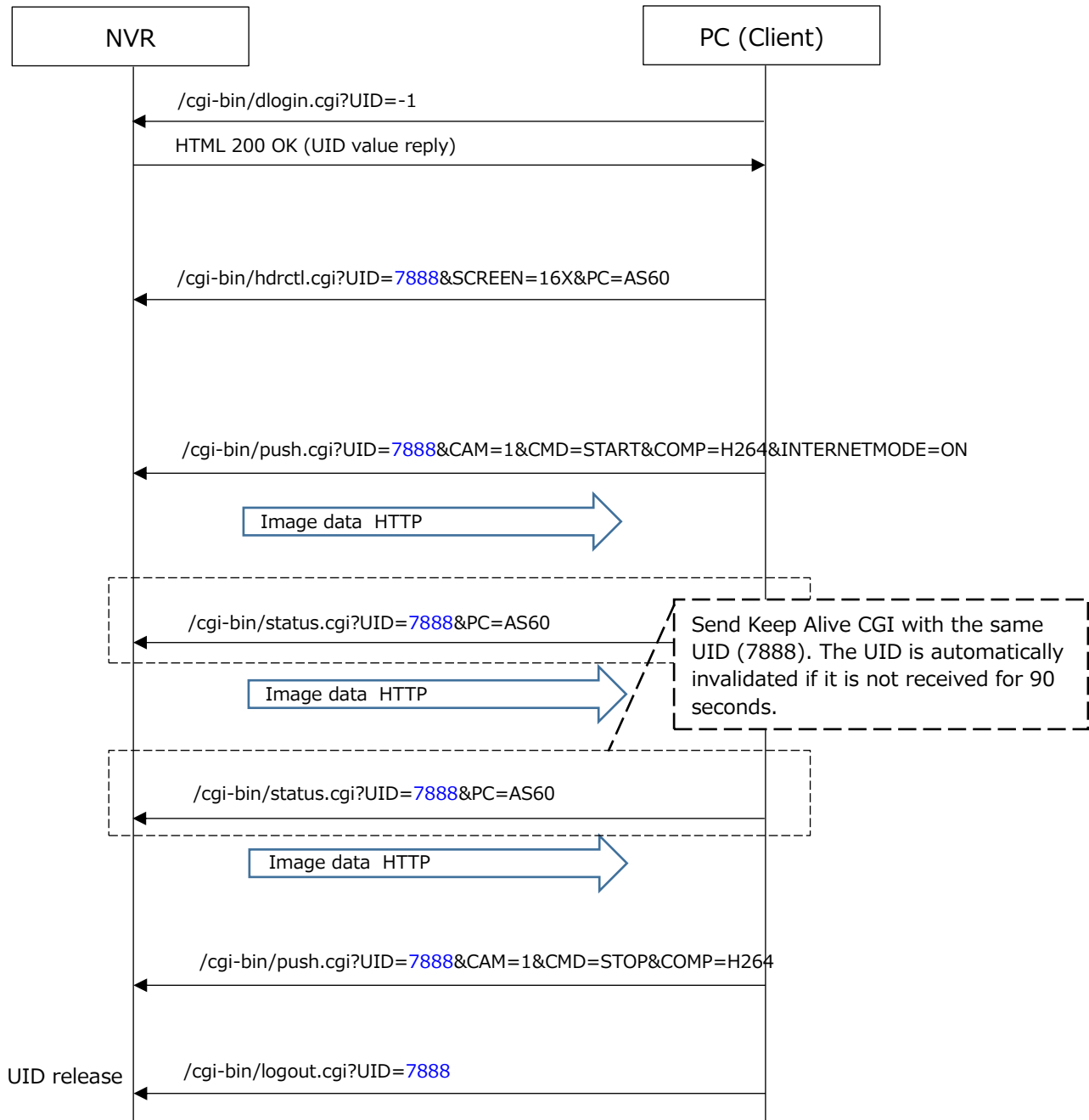

2.2.2. Command format

2.2.2.1. Recorder Control command (Setup Live)

The Recorder Control command is the same as the command for live with RTP.

2.2.2.2. Start/Stop command for Live streaming

[URL]

/cgi-bin/push.cgi?

UID=<value>&CAM=<value>&CMD=<value>&COMP=<value>&INTERNETMODE=<value>

[Method] GET

Parameter name	Value	Comments
UID	(Numeric)	Issued User ID
CAM	(Numeric)	Camera number *Camera number registered in the NVR.
CMD	START STOP	Command START: Start live streaming STOP: Stop live streaming
COMP	H264 H265 AUDIO	Data format H264: H.264 video H265: H265 video AUDIO: Audio *Audio-only stream transmission is not available. Send a command with video parameter before sending a command with audio parameter.
INTERNETMODE	ON	Fixed value

2.3. Data format

2.3.1. Live H.264 with RTP

(1) H.264 data format and RTP packets.

The relationship between H.264 ES data and RTP packets is shown below.

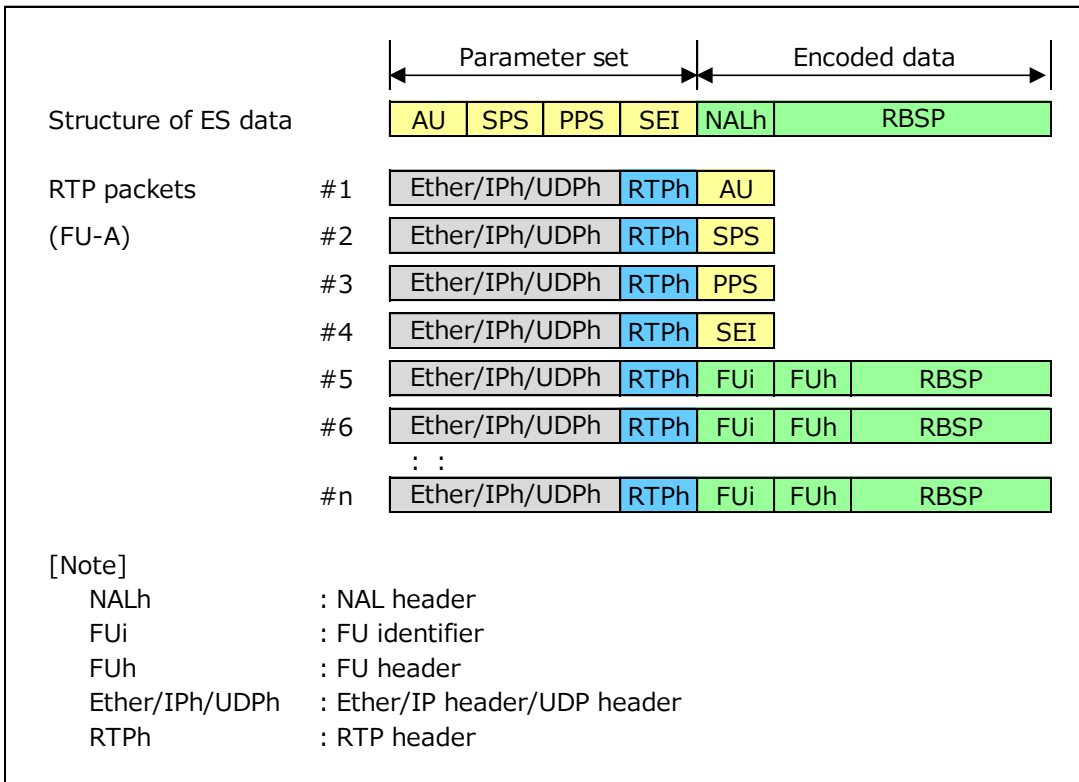

The figure above describes an IDR picture. For P pictures, SPS is not included. The contents of the parameter set and encoded data (FU: Fragmentation unit, RBSP, etc.) depend on the camera's specifications.

(2) RTP header format

The RTP header format for H.264 RTP transmission is shown below. RTP headers may contain header extensions. The header extension area contains Camera channel information(0x0004), Time and Date information(0x0007), etc. See the Additional information section below for details.

0	V	P	X	CC	M	PT	Sequence number
4	Timestamp						
8	SSRC (Synchronization Source Identifire)						
12	Defined by profile					Extension length	
16	Additional Information (1)						
	: : : :						
	Additional Information (n)						

Parameter	length (Bit)	Values and comments
V (Version)	2	2 (fixed)
P (Padding)	1	0 (fixed)
X (Extension)	1	0: false, 1:true
CC (CSRC Count)	4	0 (fixed)
M (Marker)	1	In case of the last RTP packet of a picture, this value is set to 1.
PT (Payload Type)	7	98:H.264, 101:H.265
Sequence number	16	The value in which one increment is done in each RTP packet is set. An initial value is generated at random.
Timestamp	32	Time stamp
SSRC	32	Follow the specification
CSRC	0	Unused
Defined by profile	16	0 (fixed)
Extension length	16	Length of the Header Extension (Unit of 32bit word)
Additional Information		

2.3.2. Live H.265 with RTP

(1) H.266 data format and RTP packets

The relationship between H.265 ES data and RTP packet structure is the same as that of H.264. The contents of the parameter set and encoded data (FU: Fragmentation unit, RBSP, tile, etc.) depend on the camera's specifications.

(2) RTP header format

The RTP header format for H.265 RTP transmission is the same as for H.264.

2.3.3. Live H.264 with HTTP/HTTPS

The video packet structure for H.264 HTTP/HTTPS stream transmission is a structure for distributing ES data including RTP headers and parameter sets for RTP stream transmission in HTTP/HTTPS multipart.

http multipart	--myboundary[CR][LF]
	Content-type: application/octet-stream[CR][LF]
	Content-Length: *****[CR][LF]
Video data	ES (Video data)
http multipart	--myboundary[CR][LF]
	Content-type: application/octet-stream[CR][LF]
	Content-Length: *****[CR][LF]

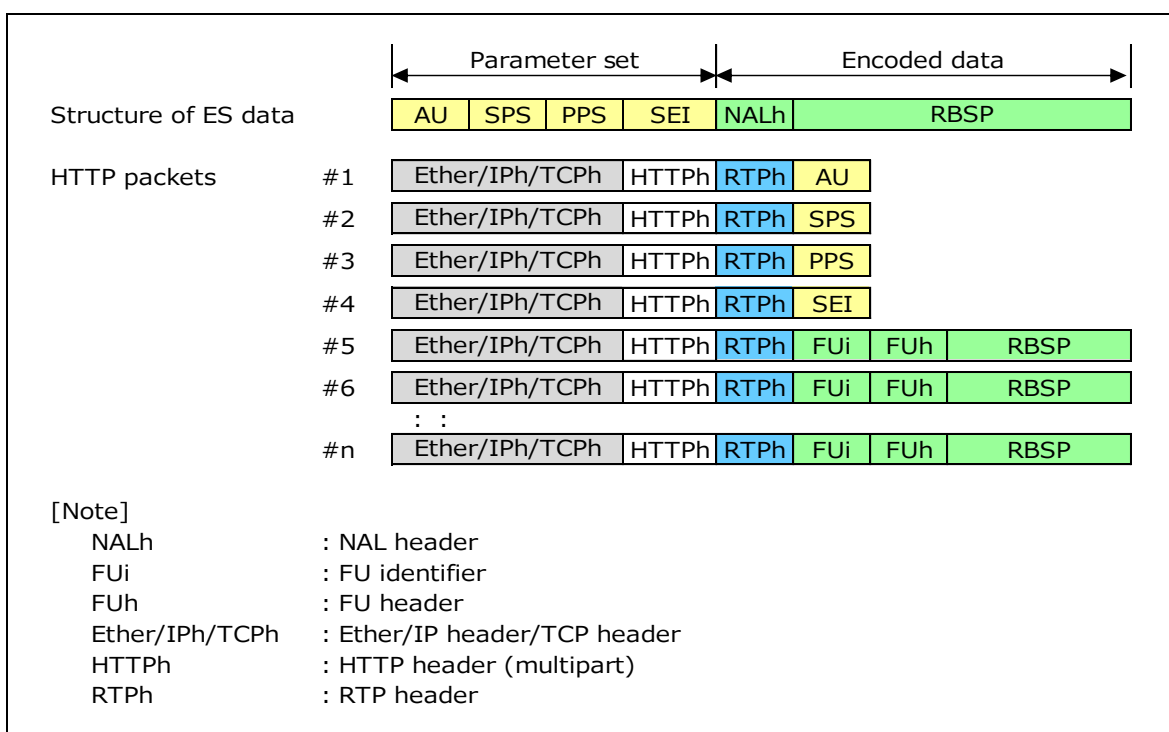

The figure above describes an IDR picture. For P pictures, SPS is not included. The contents of the parameter set and encoded data (FU, RBSP, etc.) depend on the camera's specifications. RTP headers may contain header extensions. The header extension area contains Camera channel information(0x0004), Time and Date information(0x0007), etc. See the Additional information section below for details.

2.3.4. Live H.265 with HTTP/HTTPS

The H.265 video packet structure for HTTP (HTTPS) is the same as the H.264 structure.

2.3.5. Live Audio with RTP

The structure of an audio packet depends on the audio compression method.

(1) G.711/G.726

Send the audio data (ES) after sending the RTP header.

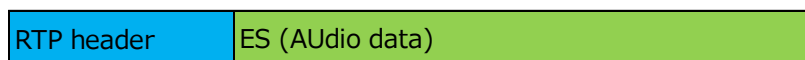

(2) AAC-LC

Send the audio data (ES) after sending the RTP header.

AU header (4 bytes) is allocated between RTP header and audio data (ES).

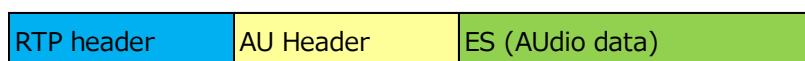

(3) RTP header format

RTP header format for audio stream transmission is shown below. RTP headers may contain header extensions. The header extension area contains Time and Date information(0x0011), etc. See the Additional information section below for details.

Byte	0				8			16			24
	2	1	1	4	1	7	8		8		
0	V	P	X	CC	M	PT		Sequence number			
4	Timestamp										
8	SSRC (Synchronization Source Identifire)										
12	Defined by profile						Extension length				
16	Additional Information (1)										
	: : : :										
	Additional Information (n)										

Parameter	length (Bit)	Values and comments
V (Version)	2	2 (fixed)
P (Padding)	1	0 (fixed)
X (Extension)	1	0: false, 1:true
CC (CSRC Count)	4	0 (fixed)
M (Marker)	1	In case of the last RTP packet of a picture, this value is set to 1.
PT (Payload Type)	7	97: Audio data
Sequence number	16	The value in which one increment is done in each RTP packet is set. An initial value is generated at random.
Timestamp	32	Time stamp
SSRC	32	Follow the specification
CSRC	0	Unused
Defined by profile	16	0 (fixed)
Extension length	16	Length of the Header Extension (Unit of 32bit word)
Additional Information		

2.3.6. Live Audio with HTTP/HTTPS

(1) Audio data format

Audio packets for HTTP/HTTPS are transmitted in HTTP/HTTPS multipart in the following data format.

- In the case of AAC-LC, ES data with 0x00 (1 Byte) added to the beginning is transmitted, excluding the RTP and AU headers.
- For other than AAC-LC, ES data with 0x00 (1 Byte) added to the beginning is transmitted, excluding the RTP header.

The following Audio data contains the same audio data (ES) as RTP transmission.

http multipart	--myboundary[CR][LF]	
	Content-Type: audio/48kaac-lc[CR][LF]	
	Content-Length: *****[CR][LF]	
Audio data	0x00	ES (Audio data)
http multipart	--myboundary[CR][LF]	
	Content-Type: audio/48kaac-lc[CR][LF]	
	Content-Length: *****[CR][LF]	

* Content-Type for G.726 is "audio/g.726-32k".

3. Playback

3.1. Control sequence for Playback

3.1.1. Playback start

Example HTTP streaming

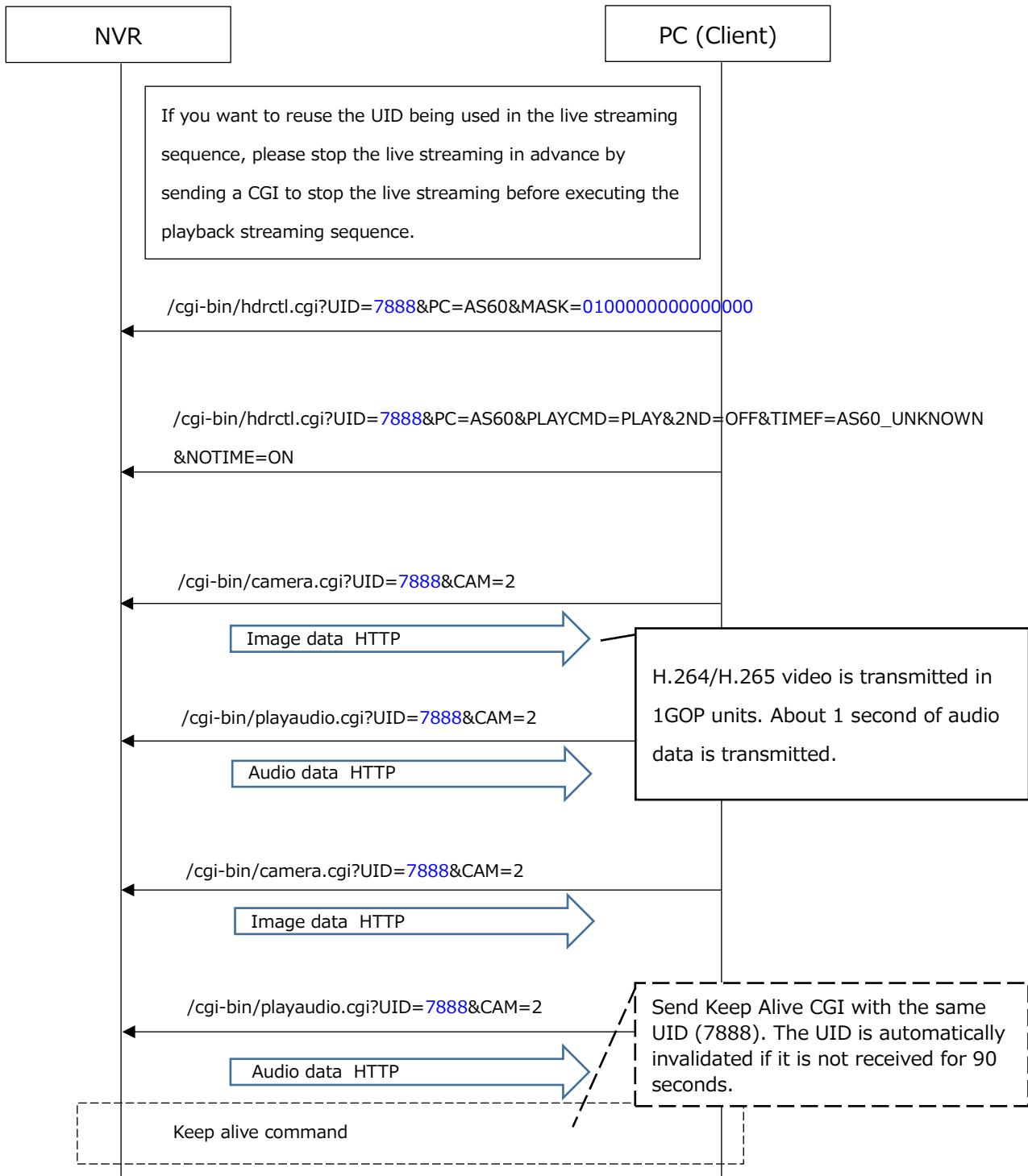

3.1.2. Reverse

Example HTTP streaming

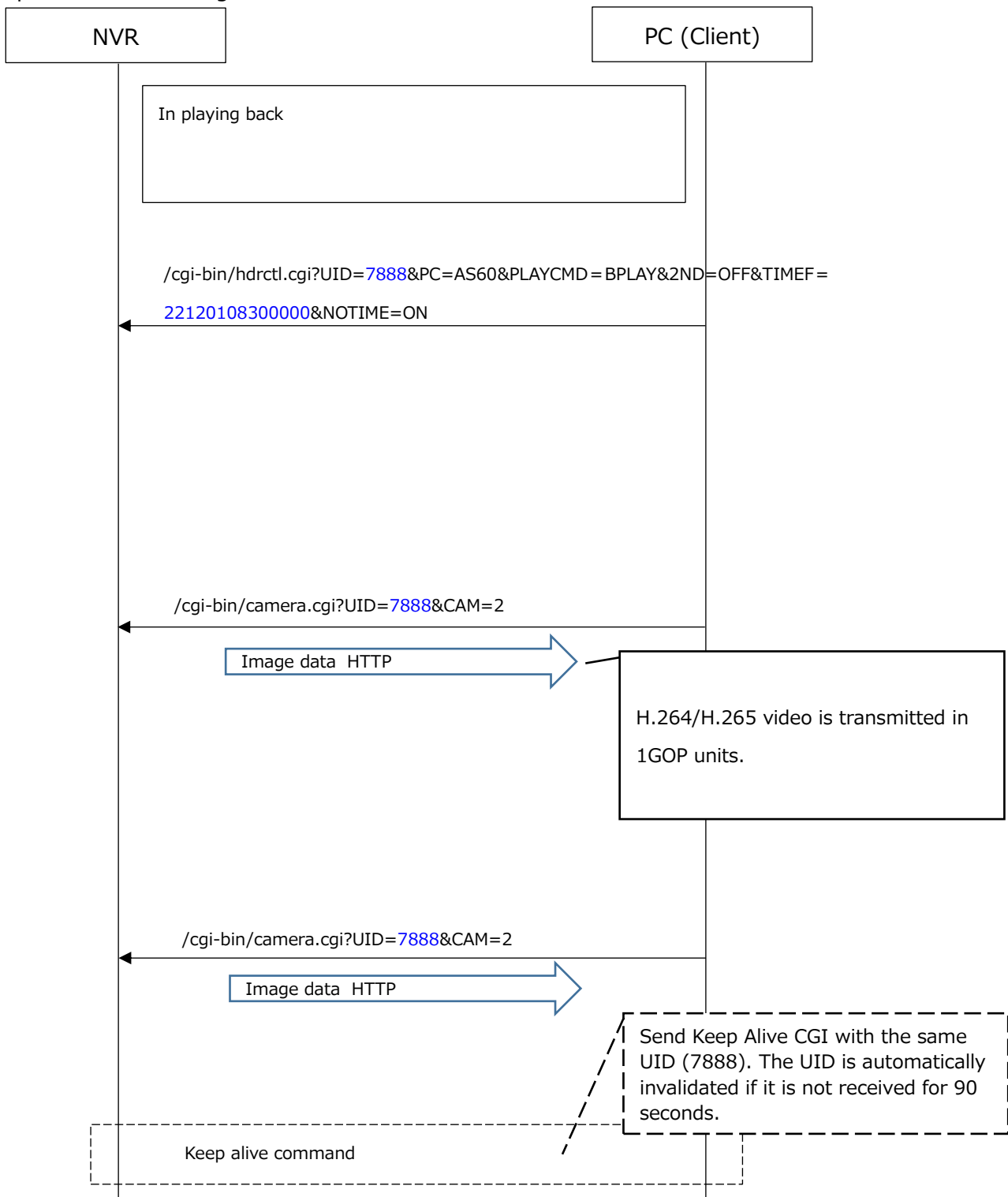

3.1.3. Pause

Example HTTP streaming

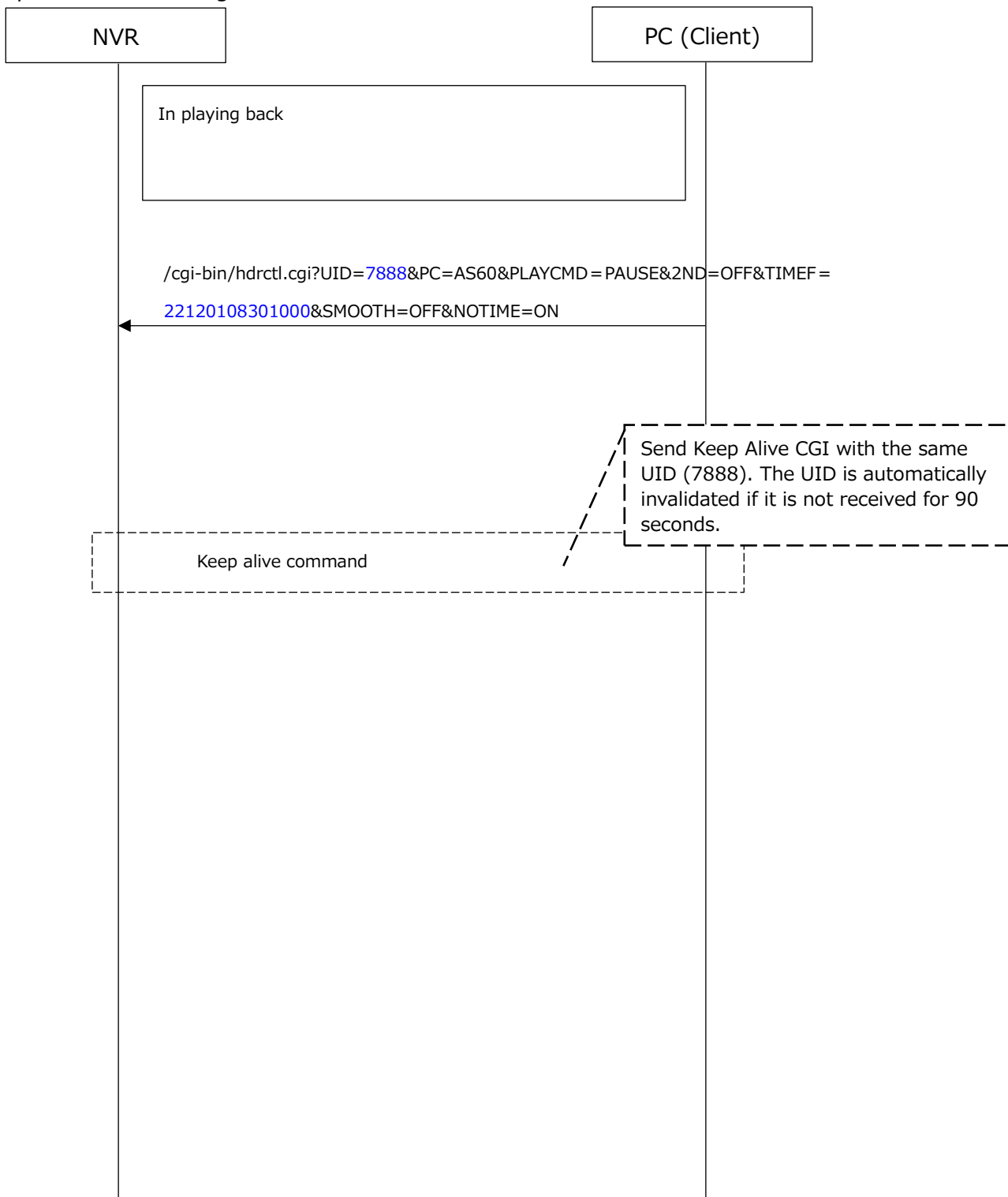

3.1.5. Playback by specifying time and date

Example HTTP streaming

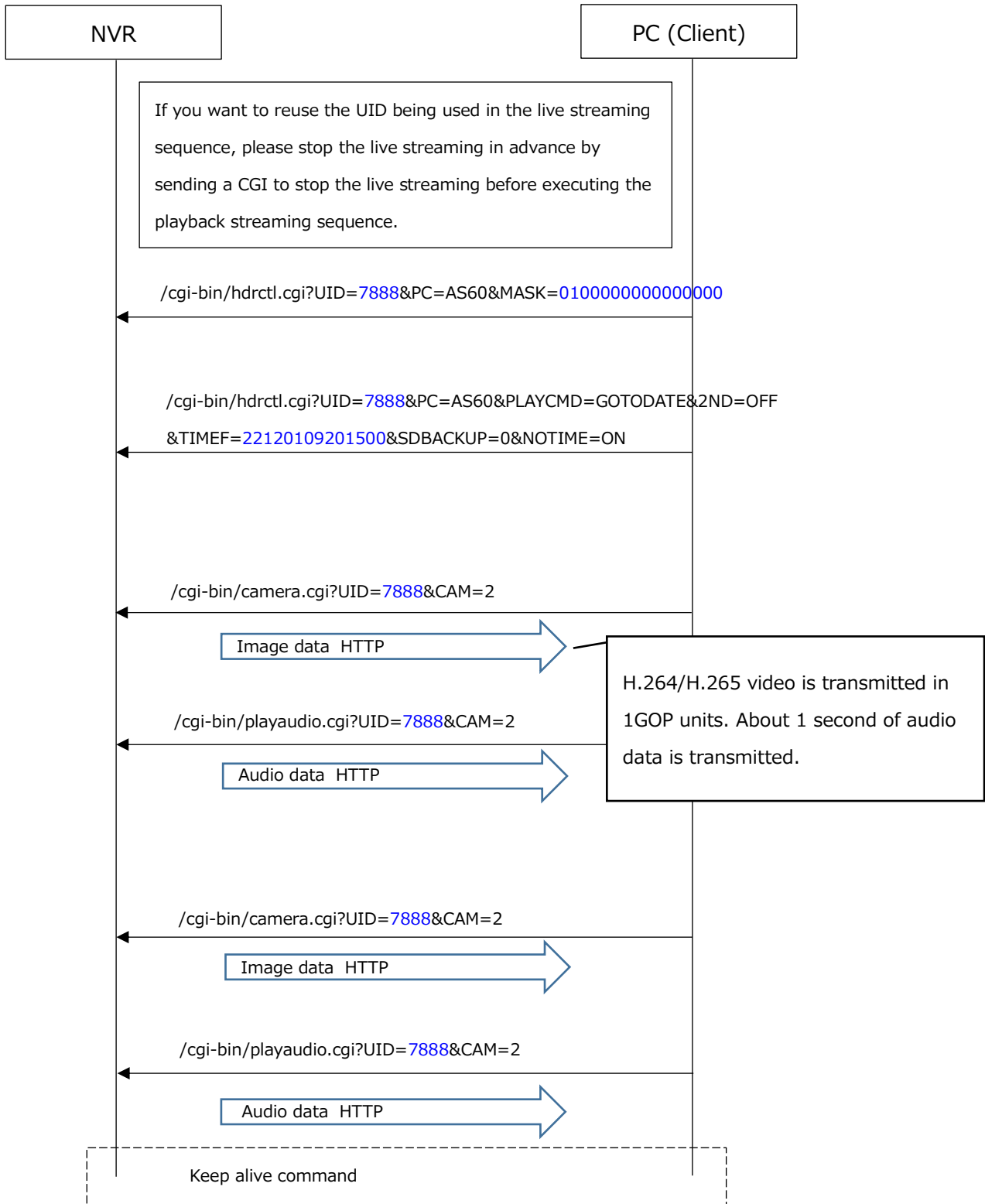

3.1.6. Fast forward

Example HTTP streaming

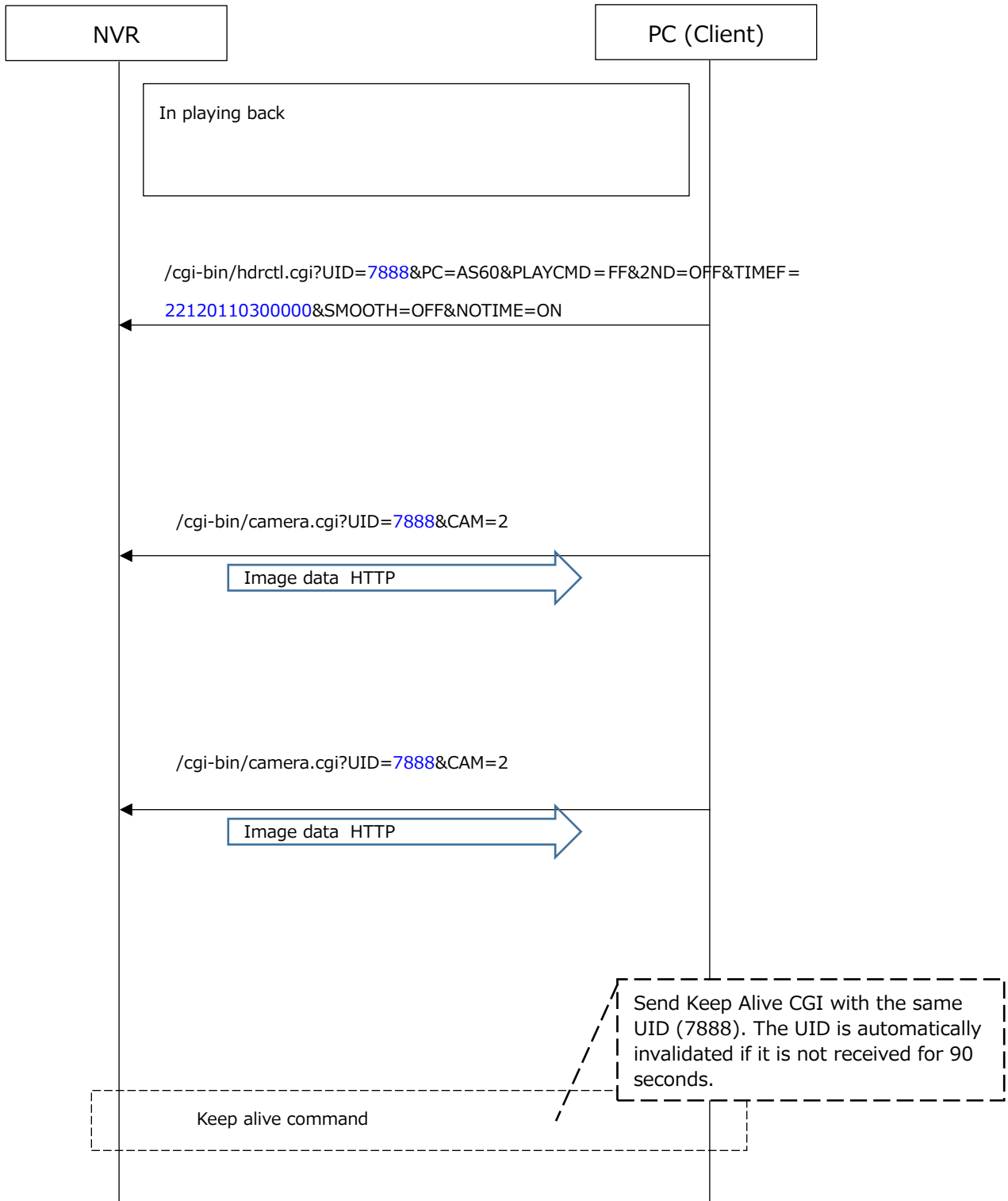

3.1.7. Playback stop

Example HTTP streaming

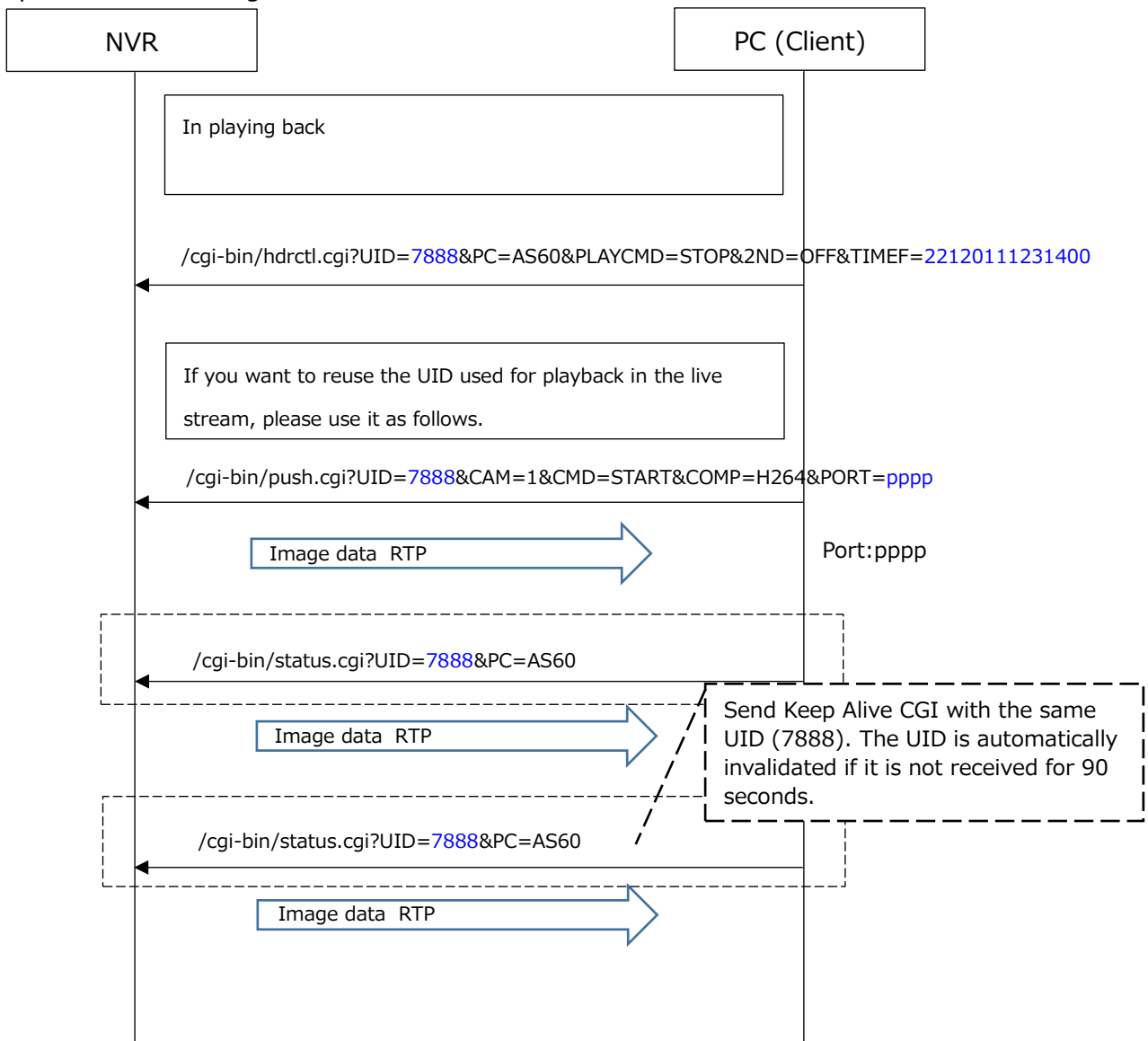

3.2. Command format

3.2.1. Playback Video Request command

[URL]

/cgi-bin/camera.cgi?UID=<value>&CAM=<value>

[Method] GET

Parameter name	Value	Comments
UID	(Numeric)	Issued User ID
CAM	(Numeric)	Camera channel number *Camera number registered in the NVR.
NOTE: H.264/H.265 video is transmitted as 1 GOP of data. The start time of GOP is near the date and time specified in the TIMEF parameter of the previously sent Recorder Control command (hdrctl.cgi).		

3.2.2. Playback Audio Request command

[URL]

/cgi-bin/playaudio.cgi?UID=<value>&CAM=<value>

[Method] GET

Parameter name	Value	Comments
UID	(Numeric)	Issued User ID
CAM	(Numeric)	Camera channel number *Camera number registered in the NVR.
NOTE: About 1 second of audio data is transmitted.		

3.2.3. Recorder Control command (Camera channel to playback)

[URL]

/cgi-bin/hdrctl.cgi?UID=<value>&PC=AS60&MASK=<value>

[Method] GET

Parameter name	Value	Comments
UID	(Numeric)	Issued User ID
PC	AS60	Fixed value
MASK	(Numeric) *The number of digits is the number of supported cameras by NVR.	Specify camera channel to playback 1: Camera channel to playback 0: Camera channel not to playback Example When playing back a camera with CAM NUMBER 2 using 16 cameras 0100000000000000 * Camera number 1 on the left
<p>NOTE: Send this command first before playback starts. If changing the camera number to playback, send it every time. Reference: 3.1.1. Playback start</p>		

3.2.4. Recorder Control command (Playback start)

[URL]

/cgi-bin/hdrctl.cgi?UID=<value>&PC=AS60&PLAYCMD=PLAY&2ND=OFF&TIMEF=AS60_UNKNOWN
&NOTIME=ON

[Method] GET

Parameter name	Value	Comments
UID	(Numeric)	Issued User ID
PC	AS60	Fixed value
PLAYCMD	PLAY	Recorder Control PLAY: Start playback
2ND	OFF	Fixed value
TIMEF	AS60_UNKNOWN	Fixed value
NOTIME	ON	Fixed value
<p>NOTE: Send this command to start playback. Reference: 3.1.1. Playback start</p>		

3.2.5. Recorder Control command (Reverse playback start)

[URL]

/cgi-bin/hdrctl.cgi?UID=<value>&PC=AS60&PLAYCMD=BPLAY&2ND=OFF&TIMEF=yymmddhhmmssff&NOTIME=ON

[Method] GET

Parameter name	Value	Comments
UID	(Numeric)	Issued User ID
PC	AS60	Fixed value
PLAYCMD	BPLAY	Recorder Control BPLAY: Start reverse playback
2ND	OFF	Fixed value
TIMEF	Year, month, day, hour, minute, second, 10 millisecond	Specified time and date yy:Year(22:2022,23:2023,,,35:2035) mm:Month(1,2,,,12) dd:Day(1,2,,,31) hh:Hour(0,1,,,23) mm:Minute(0,1,,,59) ss:Second(0,1,,,59) ff: 10 Millisecond (00 Fixed value) *Specify UTC time for TIMEF.
NOTIME	ON	Fixed value
<p>NOTE:</p> <p>H.264 and H.265 playback video are obtained in units of GOPs using the "Playback Video Request command (camera.cgi)". After sending the above Recorder Control command (Reverse playback start)", if you send the "Playback Video Request command (camera.cgi)", you can obtain the GOP data one before in time order.</p> <p>Reference: 3.1.2. Reverse</p>		

3.2.6. Recorder Control command (Pause)

[URL]

/cgi-bin/hdrctl.cgi?UID=<value>&PC=AS60&PLAYCMD=PAUSE&2ND=OFF&TIMEF=yymmddhhmmssff&SMOOTH=OFF&NOTIME=ON

[Method] GET

Parameter name	Value	Comments
UID	(Numeric)	Issued User ID
PC	AS60	Fixed value
PLAYCMD	PAUSE	Recorder Control PAUSE: Pause playback
2ND	OFF	Fixed value
TIMEF	Year, month, day, hour, minute, second, 10 millisecond	Specified time and date *Specify the time and date of the displayed video yy:Year(22:2022,23:2023,,,35:2035) mm:Month(1,2,,,12) dd:Day(1,2,,,31) hh:Hour(0,1,,,23) mm:Minute(0,1,,,59) ss:Second(0,1,,,59) ff: 10 Millisecond (00 Fixed value) *Specify UTC time for TIMEF.
SMOOTH	OFF	Fixed value
NOTIME	ON	Fixed value
NOTE: Send this command to pause playback Reference: 3.1.3. Pause		

3.2.7. Recorder Control command (Next image / Previous image)

[URL]

/cgi-bin/hdrctl.cgi?UID=<value>&PC=AS60&PLAYCMD=NEXTFRAME&2ND=OFF&TIMEF=yymmddhhmmssff&NOTIME=ON

[Method] GET

Parameter name	Value	Comments
UID	(Numeric)	Issued User ID
PC	AS60	Fixed value
PLAYCMD	NEXTFRAME PREVFRAME	Recorder Control NEXTFRAME: Next image PREVFRAME: Previous image
2ND	OFF	Fixed value
TIMEF	Year, month, day, hour, minute, second, 10 millisecond	Specified time and date *Specify the time and date of the displayed video yy:Year(22:2022,23:2023,,,35:2035) mm:Month(1,2,,,12) dd:Day(1,2,,,31) hh:Hour(0,1,,,23) mm:Minute(0,1,,,59) ss:Second(0,1,,,59) ff: 10 Millisecond (00,01,,99) 10msec units *Specify UTC time for TIMEF.
NOTIME	ON	Fixed value

NOTE:

H.264 and H.265 playback images are obtained in units of GOPs using the "Playback Video Request command (camera.cgi)". One GOP contains multiple images. In frame-by-frame processing, the images in the obtained GOP are displayed one by one. When there are no more images to display in the GOP, request the next GOP with the "Playback Video Request command (camera.cgi)" command. Images in GOP are arranged in the order of recording. For reverse frame-by-frame playback, rearrange the decoded video in the display order as necessary.

Reference: 3.1.4. Next image / Previous image

3.2.8. Recorder Control command (Playback by specifying time and date)

[URL]

/cgi-bin/hdrctl.cgi?UID=<value>&PC=AS60&PLAYCMD=GOTODATE&2ND=OFF&TIMEF=yymmddhhmmssff
&SDBACKUP=0&NOTIME=ON

[Method] GET

Parameter name	Value	Comments
UID	(Numeric)	Issued User ID
PC	AS60	Fixed value
PLAYCMD	GOTODATE	Recorder Control GOTODATE: Start playback (Time & Date)
2ND	OFF	Fixed value
TIMEF	Year, month, day, hour, minute, second, 10 millisecond	Time and date for playback yy:Year(22:2022,23:2023,,,35:2035) mm:Month(1,2,,,12) dd:Day(1,2,,,31) hh:Hour(0,1,,,23) mm:Minute(0,1,,,59) ss:Second(0,1,,,59) ff: 10 Millisecond (00 Fixed value) *Specify UTC time for TIMEF.
SDBACKUP	0	Fixed value
NOTIME	ON	Fixed value
NOTE: Send this command to start playback (Time and Date). Reference: 3.1.5. Playback by specifying time and date		

3.2.9. Recorder Control command (Fast forward / Fast reverse)

[URL]

/cgi-bin/hdrctl.cgi?UID=<value>&PC=AS60&PLAYCMD=FF&2ND=OFF&TIMEF=
 yymmddhhmmssff&SMOOTH=OFF&NOTIME=ON

[Method] GET

Parameter name	Value	Comments
UID	(Numeric)	Issued User ID
PC	AS60	Fixed value
PLAYCMD	FF REW	Recorder Control FF: Fast forward REW: Fast reverse
2ND	OFF	Fixed value
TIMEF	Year, month, day, hour, minute, second, 10 millisecond	Specified time and date *Specify the time and date of the displayed video yy:Year(22:2022,23:2023,,,35:2035) mm:Month(1,2,,,12) dd:Day(1,2,,,31) hh:Hour(0,1,,,23) mm:Minute(0,1,,,59) ss:Second(0,1,,,59) ff: 10 Millisecond (00 Fixed value) *Specify UTC time for TIMEF.
SMOOTH	OFF	Fixed value
NOTIME	ON	Fixed value
<p>NOTE: Sending this command repeatedly increases the playback speed. As a result, the GOP obtained by the Playback Video Request command (camera.cgi) becomes discontinuous in terms of time. Reference: 3.1.6. Fast forward</p>		

3.2.10. Recorder Control command (Playback stop)

[URL]

/cgi-bin/hdrctl.cgi?UID=<value>&PC=AS60&PLAYCMD=STOP&2ND=OFF&TIMEF=yymmddhhmmssff

[Method] GET

Parameter name	Value	Comments
UID	(Numeric)	Issued User ID
PC	AS60	Fixed value
PLAYCMD	STOP	Recorder Control STOP: Stop playback
2ND	OFF	Fixed value
TIMEF	Year, month, day, hour, minute, second, 10 millisecond	Specified time and date yy:Year(22:2022,23:2023,,,35:2035) mm:Month(1,2,,,12) dd:Day(1,2,,,31) hh:Hour(0,1,,,23) mm:Minute(0,1,,,59) ss:Second(0,1,,,59) ff: 10 Millisecond (00 Fixed value) *Specify UTC time for TIMEF.

NOTE:

Reference: 3.1.7. Playback stop

3.3. Data format

3.3.1. Playback video

Playback video is transmitted by HTTP/HTTPS in units of 1 GOP of H.264 or H.265.

http	HTTP/1.1 200 OK[CR][LF]
	Connection: Keep-Alive[CR][LF]
	Cache-Control: no-cache[CR][LF]
	Content-type: application/octet-stream[CR][LF]
	Content-Length: *****[CR][LF][CR][LF]
Video data	Video data format (Refer to below)

3.3.1.1. Data format for H.264

Items	Size [Byte]	Data		Comments
Chunk ID header	4	0xFF15	Length	Recorder information *1 generated by NVR.
Recorder info.	4	<i>Rec info. ID[1]</i>	<i>Length[1]</i>	
	Length[1] -4	<i>Data[1]</i>		
	-	: : : : : :		
	4	<i>Rec info. ID[m]</i>	<i>Length[m]</i>	
	Length[m] -4	<i>Data[m]</i>		
Camera info.	4	<i>Cam info. ID[1]</i>	<i>Length[1]</i>	Camera information *2 generated by camera.
	Length[1] -4	<i>Data[1]</i>		
	-	: : : : : :		
	4	<i>Cam info. ID[n]</i>	<i>Length[n]</i>	
	Length[n] -4	<i>Data[n]</i>		
Reserved	12	-		
Stream ID header	4	0xFF06	Length=0x0044	
GOP information	32	<i>Data</i>		GOP information *3
PIC information	32	<i>Data</i>		PIC information *4
Packet ID header	4	0xFF05	Num. of Padding	Num of bytes of "Zero padding"
	4	Length		
Reserved	16	-		
Video data *5	4	0x00	0x000001	Start code
	-	AUD		
	4	0x00	0x000001	Start code
	-	SPS		
	4	0x00	0x000001	Start code
	-	PPS		
	4	0x00	0x000001	Start code
	-	SEI		
	4	0x00	0x000001	Start code
	-	IDR, P		
		Zero padding area		For 4Byte alignment
Camera info. Packet ID header ... Video data ...				
Camera info. Packet ID header ... Video data				
Padding		Padding data		For 4K Byte alignment

*1) Recorder information: Additional information generated by the NVR.

The content differs depending on the model and operation.

See the Additional information section below.

*2) Camera information: Additional information generated by i-PRO cameras.

Depending on the video, this information may not be available.

*3) GOP information:

Items	Size [Byte]	Data				Comments
GOP information	16	Reserved				
	4	Time & date (End)				*3-1
	4	10msec	TZ Hour	TZ Minute	TZ info	*3-2
	4	Time & date (Start)				*3-3
	4	10msec	TZ Hour	TZ Minute	TZ info	*3-4

*3-1) Time & date (End): GOP end time (Seconds since the Unix epoch)

*3-2) Supplementary information for Time & date (End)

10msec: 10 millisecond units

TZ Hour, TZ Minute: Hour and minute values for time zone information

TZ info: (1Byte)

Bit 7	6	5	4	3	2	1	0
Time zone sign 0: +, 1: -	Summer time 0: OUT, 1: IN	Reserved					

*3-3) Time & date (Start): GOP start time (Seconds since the Unix epoch)

*3-4) Supplementary information for Time & date (Start)

10msec: 10 millisecond units

TZ Hour, TZ Minute: Hour and minute values for time zone information

TZ info: (1Byte)

Bit 7	6	5	4	3	2	1	0
Time zone sign 0: +, 1: -	Summer time 0: OUT, 1: IN	Reserved					

*4) PIC information:

Items	Size [Byte]	Data				Comments
PIC information	16	Reserved				
	4	Time & date				*4-1
	4	10msec	Reserved			*4-2
	8	Reserved				

*4-1) Time & date: Image time (Seconds since the Unix epoch)

*4-2) 10msec: 10 millisecond units

*5) Divided FU data are combined and stored. Parameter sets (AUD, SPS, PPS, SEI, etc.) are stored according to H.264. Each data is combined by a start code. The data end is aligned (4 bytes) with the number of 0x00 data specified by Num. of Padding.

3.3.1.2. Data format for H.265

The structure for H.265 is basically the same as the structure for H.264 except for storing each ID value and tile structures. Value of Chunk ID is 0xFF16.

Items	Size [Byte]	Data		Comments
Chunk ID header	4	0xFF16	Length	
Recorder info.	4	<i>Rec info. ID[1]</i>	<i>Length[1]</i>	Recorder information *1 generated by NVR.
	<i>Length[1]</i> -4	<i>Data[1]</i>		
	-	: : : : : :		
	4	<i>Rec info. ID[m]</i>	<i>Length[m]</i>	
Camera info.	4	<i>Cam info. ID[1]</i>	<i>Length[1]</i>	Camera information *2 generated by camera.
	<i>Length[1]</i> -4	<i>Data[1]</i>		
	-	: : : : : :		
	4	<i>Cam info. ID[n]</i>	<i>Length[n]</i>	
Camera info.	<i>Length[n]</i> -4	<i>Data[n]</i>		
	-	: : : : : :		
	4	<i>Cam info. ID[n]</i>	<i>Length[n]</i>	
	<i>Length[n]</i> -4	<i>Data[n]</i>		
Reserved	12	-		
Stream ID header	4	0xFF06	Length=0x0044	
GOP information	32	Data		GOP information *3
PIC information	32	Data		PIC information *4
Packet ID header	4	0xFF05	Num. of Padding	Num of bytes of "Zero padding"
	4	Length		
Reserved	16	-		
Video data *5	4	0x00	0x000001	Start code
	-	AUD		
	4	0x00	0x000001	Start code
	-	SPS		
	4	0x00	0x000001	Start code
	-	PPS		
	4	0x00	0x000001	Start code
	-	SEI		
	4	0x00	0x000001	Start code
	-	1st tile of IDR, P		
	4	0x00	0x000001	
	-	2nd tile of IDR, P		
	4	0x00	0x000001	
	-	Nth tile of IDR, P		
		Zero padding area		For 4Byte alignment
Camera info. Packet ID header ...Video data ...				
Camera info. Packet ID header ...Video data				
Padding		Padding data		For 4K Byte alignment

- *1) Recorder information: Additional information generated by the NVR.
The content differs depending on the model and operation.
See the Additional information section below.
- *2) Camera information: Additional information generated by i-PRO cameras.
Depending on the video, this information may not be available.
- *3) GOP information: The structure is basically the same as the structure for H.264.
- *4) PIC information: The structure is basically the same as the structure for H.264.
- *5) Divided FU data are combined and stored. Parameter sets (AUD, SPS, PPS, SEI, etc.) are stored according to H.264. Each data, including tile data, is combined by a start code. The data end is aligned (4 bytes) with the number of 0x00 data specified by Num. of Padding.

3.3.2. Playback audio

Playback audio is transmitted by HTTP/HTTPS in units of about 1 second of data.

http	HTTP/1.1 200 OK[CR][LF]
	Connection: Keep-Alive[CR][LF]
	Cache-Control: no-cache[CR][LF]
	Content-type: application/octet-stream[CR][LF]
	Content-Length: *****[CR][LF][CR][LF]
Video data	Audio data format (Refer to below)

3.3.2.1. Data format for G.711 / G.726

Items	Size [Byte]	Data				Comments
Audio header 0xFF03 (G711,G726)	4	0xFF03	Cam.Ch.			Cam.Ch = Camera number
	4	Audio data size				
	0					(Omitted)
	4	Time & date (Start)				*1
	4	Reserved	TZ Hour	TZ Minute	TZ info	*1
	4	Time & date (End)				*2
	4	Reserved				
	4	TZ sign	TZ Hour	TZ Minute	SMR Time	*2
	4	Codec	Reserved			*3
	4	Reserved				
	28	Reserved				
Audio data		0x00	Audio data (about 1 sec)			*4
Padding		padding data				For 4K Byte alignment

*1) Start time information of stored audio data

Time & date (Start): Start time (Seconds since the Unix epoch)

TZ Hour, TZ Minute: Hour and minute values for time zone information

TZ info: (1Byte)

Bit 7	6	5	4	3	2	1	0
Time zone sign 0: +, 1: -	Summer time 0: OUT, 1: IN	Reserved					

*2) End time information of stored audio data

Time & date (End): End time (Seconds since the Unix epoch)

TZ sign, TZ Hour, TZ Minute: Hour and minute values for time zone information

SMR Time (Summer time): 0x00: OUT, 0x01: IN

*3) Codec type

0x00: G.726, 0x01: G.711

*4) Audio data

If 0x00 is attached to the first 1 byte, discard 0x00 as unnecessary data.

3.3.2.2. Data format for AAC-LC

Items	Size [Byte]	Data	Comments
Audio header 0xFF13 (AAC-LC)	4	0xFF13 Cam.Ch.	Cam.Ch = Camera number
	4	Audio data size	
	4	0xFF12 Length	Length=0x003C
	4	Time & date (Start)	*1
	4	Reserved TZ Hour TZ Minute TZ info	*1
	4	Time & date (End)	*2
	4	Reserved	
	4	TZ sign TZ Hour TZ Minute SMR Time	*2
	4	Reserved	
	4	Reserved	
	28	Reserved	
Audio data		Audio data for AAC-LC (about 1 sec)	*3
Padding		padding data	For 4K Byte alignment

*1) Start time information of stored audio data

Time & date (Start): Start time (Seconds since the Unix epoch)

TZ Hour, TZ Minute: Hour and minute values for time zone information

TZ info: (1Byte)

Bit 7	6	5	4	3	2	1	0
Time zone sign 0: +, 1: -	Summer time 0: OUT, 1: IN	Reserved					

*2) End time information of stored audio data

Time & date (End): End time (Seconds since the Unix epoch)

TZ sign, TZ Hour, TZ Minute: Hour and minute values for time zone information

SMR Time (Summer time): 0x00: OUT, 0x01: IN

*3) Audio data for AAC-LC

Items	Size [Byte]	Data		Comments			
Audio data	4	0xFF14	Length	*4			
	4	Padding size	AU info		↑ ↓		
		0x00					
	-	Audio data (1024 sample)					
		Zero padding area					
	4	0xFF14	Length				
	4	Padding size	AU info				
		0x00					
	-	Audio data (1024 sample)					
		Zero padding area					
		:	:	:		:	:
4	0xFF14	Length					
4	Padding size	AU info					
	0x00						
-	Audio data (1024 sample)						
	Zero padding area						

*4) Audio data

0xFF04: Header ID for area storing AAC-LC data

Padding size: Number of padding data stored in Zero padding area

AU info: Presence of AU header

0x00: Without AU header

0x01: With AU header

Audio data: It stores 1024 sample data. If 0x00 is attached to the first 1 byte, discard 0x00 as unnecessary data.

Zero padding area: Area to store padding data for 4-byte alignment

4. 4. Other sequences / commands

4.1. UID Issuance (Login) / Destruction (Logout)

4.1.1. Sequence / Command for UID Issuance (Login)

Get UID (login)

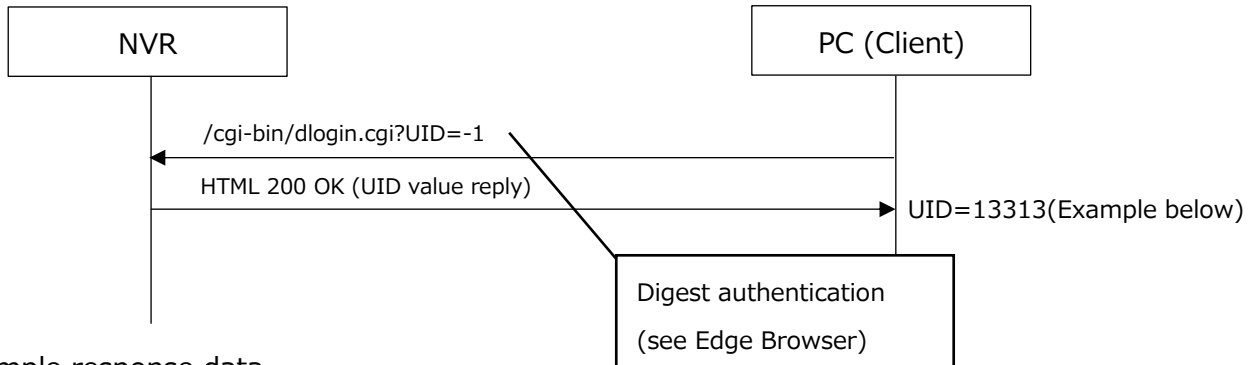

Example response data

```

<html>[CR] [LF]
<head>[CR] [LF]
<meta http-equiv="X-UA-Compatible" content="IE=edge">[CR] [LF]
<meta http-equiv="Content-Type" content="text/html; charset=UTF-8">[CR] [LF]
<meta http-equiv="Content-Script-Type" content="text/javascript">[CR] [LF]
<meta http-equiv="Pragma" content="no-cache">[CR] [LF]
<link rel="stylesheet" type="text/css" href="../rec_common_mlt.css">[CR] [LF]
<title>Network Disk Recorder WJ-NX400</title>[CR] [LF]
<script language="JavaScript" src="../setup_mlt.js"></script>[CR] [LF]
</head>[CR] [LF]
<body leftmargin="0" topmargin="0" marginwidth="0" marginheight="0" oncontextmenu="return false">[CR] [LF]
<script type="text/javascript">[CR] [LF]
<!--[CR] [LF]
¥tif("J" == "G") [CR] [LF]
¥t{[CR] [LF]
¥t¥tdocument.title = "Network Disk Recorder WJ-NX400";[CR] [LF]
¥t}[CR] [LF]
¥telse[CR] [LF]
¥t{[CR] [LF]
¥t¥tdocument.title = "Network Disk Recorder WJ-NX400";[CR] [LF]
¥t}[CR] [LF]
[CR] [LF]
¥tthis.location.href = ". /hdrctl.cgi?UID=13313&HTML=camindex.html"+ RetTempParam();[CR] [LF]
//-->[CR] [LF]
</script>[CR] [LF]
</body>[CR] [LF]
</html>[CR] [LF]
    
```

[URL]

</cgi-bin/dlogin.cgi?UID=-1>

[Method] GET

Parameter name	Value	Comments
UID	-1	Fixed value

4.1.2. Sequence / Command for UID Destruction (Logout)

Release UID (logout)

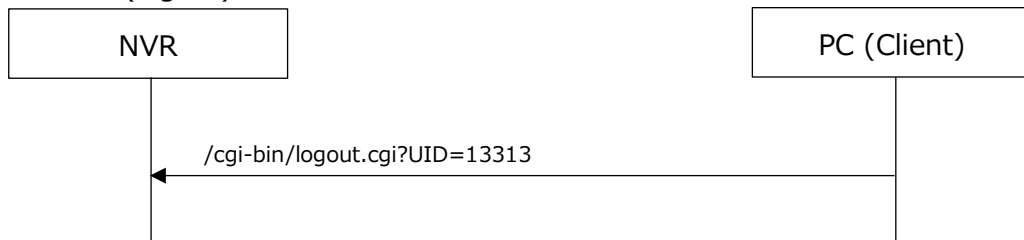

[URL]

[/cgi-bin/logout.cgi?UID=<value>](#)

[Method] GET

Parameter name	Value	Comments
UID	(Numeric)	Issued User ID

4.2. Keep Alive

[URL]

[/cgi-bin/status.cgi?UID=<value>&PC=AS60](#)

[Method] GET

Parameter name	Value	Comments
UID	(Numeric)	Issued User ID
PC	AS60	Fixed value

For sequences, see Live/playback related sequences.

5. Additional information

5.1. Recorder information ID

5.1.1. ID List

Rec info. ID	Items	Data	LV	PB
0x0004	Camera channel info.	Camera number registered in NVR	✓	✓
0x0005	Compression method info.	Compression method for video		✓
0x0006	Data size info.	Data size for video		✓
0x0007	Time and Date info.	Time and Date recorded in NVR (Seconds since the Unix epoch)	✓	✓
0x0008	Number of frame info.	Number of frame in video		✓
0x0009	Framerate info.	Framerate settings in NVR		✓
0x000A	Frame time info.	Supplementary information (in units of 10 milliseconds) for "Time and Date info.(0x0007)"		✓
0x000B	Reserved ID	–		✓
0x000C	Presence of image data info.	Indicating exist or not exist of image data in the video data area		✓
0x000D	Status info.	Operational status information	✓	✓
0x0011	Time and Date info. (Cam.)	Time and Date generated by camera (Seconds since the Unix epoch)	✓ A	
0x0012	Frame time info. (Cam.)	Supplementary information (in units of 10 milliseconds) for "Time and Date info.(0x0011)"	✓ A	
0x0027	Start Code info.	Identifier for whether H.264 and H.265 NAL units have Start Code		✓
0x0028	Long-term reference P info.	Identifier for P-picture of Long-term reference P		✓
0x0029	IDR show/hide information for long-term reference P	Auxiliary information for determining whether to display an IDR picture for a stream containing a long-term reference P. (When long-term reference P video is played back with a specified time		✓

		and date, if the time of an IDR picture is earlier than the specified time, this IDR picture does not need to be displayed after decoding.)		
--	--	---	--	--

*LV=Live, PB=Playback, A=AUDIO only

5.1.2. Data structure

Camera channel information

Parameter name	Size [Byte]	Values
Rec info. ID	2	0x0004: (Fixed value)
Length	2	0x0008: (Fixed value)
Data	2	Camera number registered in NVR 0x00nn: nn is hexadecimal.
Reserved	2	0x0000: (Fixed value)

Compression method information

Parameter name	Size [Byte]	Values
Rec info. ID	2	0x0005: (Fixed value)
Length	2	0x0008: (Fixed value)
Data	2	Compression method for video 0x0003: H.264, 0x0004: H.265
Reserved	2	0x0000: (Fixed value)

Data size information

Parameter name	Size [Byte]	Values
Rec info. ID	2	0x0006: (Fixed value)
Length	2	0x0008: (Fixed value)
Data	4	Data size 0xnxxx: xxxx is hexadecimal.

Time and Date information

Parameter name	Size [Byte]	Values
Rec info. ID	2	0x0007: (Fixed value)
Length	2	0x000C: (Fixed value)
Data	4	Time and Date recorded in NVR (Seconds since the Unix epoch)
	1	Time zone direction 0x00: Time zone (+), 0x01: Time zone (-)
	1	Hours (0-23) 0x00: 0, 0x01: 1,,,0x17: 23
	1	Minutes (0-59) 0x00: 0, 0x01: 1,,,0x3b: 59
	1	Summer time (OUT/IN) 0x00: OUT, 0x01: IN

Number of frame information

Parameter name	Size [Byte]	Values
Rec info. ID	2	0x0008: (Fixed value)
Length	2	0x0008: (Fixed value)
Data	2	Number of frame in video 0xnxxx: nxxx is hexadecimal.
Reserved	2	0x0000: (Fixed value)

Framerate information

Parameter name	Size [Byte]	Values
Rec info. ID	2	0x0009: (Fixed value)
Length	2	0x0008: (Fixed value)
Data	2	Framerate value for recording (setup value) [ips] 10 x Image/second
Reserved	2	0x0000: (Fixed value)

Frame time information (Supplementary information for ID 0x0007)

Parameter name	Size [Byte]	Values
Rec info. ID	2	0x000A: (Fixed value)
Length	2	0x0008: (Fixed value)
Data	2	Time information (in units of 10 milliseconds) 0x00: 0 [msec] 0x01: 10 [msec] : : : 0x63: 990 [msec]
Reserved	2	0x0000: (Fixed value)

Reserved ID

Parameter name	Size [Byte]	Values
Rec info. ID	2	0x000B: (Fixed value)
Length	2	0x000C: (Fixed value)
Data	8	Reserved information

Presence of image data information

Parameter name	Size [Byte]	Values
Rec info. ID	2	0x000C: (Fixed value)
Length	2	0x0008: (Fixed value)
Data	2	Indicating exist or not exist of image data in the video data area 0x0001: exist (Fixed value) 0x0000: not exist
Reserved	2	0x0000: (Fixed value)

Status information

Parameter name	Size [Byte]	Values
Rec info. ID	2	0x000D: (Fixed value)
Length	2	0x0008: (Fixed value)
Data	1	Operational status information 0x00: Undefined, 0x01: Live, 0x02: Playback, 0x03: Reverse playback, 0x04: Fast Forward, 0x05: Fast Reverse, 0x06: Pause, 0x07: Next image, 0x08: Previous image, 0x41: In downloading, 0x42: Download completed
	1	Speed of Fast forward / Reverse 0x00: Undefined, 0x01: STEP1,,, 0x08: STEP8
Reserved	2	0x0000: (Fixed value)

Time and Date information (Cam.)

Parameter name	Size [Byte]	Values
Rec info. ID	2	0x0011: (Fixed value)
Length	2	0x000C: (Fixed value)
Data	8	*Same format as Rec info.ID=0x0007

Frame time information (Cam.) (Supplementary information for ID 0x0011)

Parameter name	Size [Byte]	Values
Rec info. ID	2	0x0012: (Fixed value)
Length	2	0x0008: (Fixed value)
Data	2	*Same format as Rec info.ID=0x000A
Reserved	2	0x0000: (Fixed value)

Start code information

Parameter name	Size [Byte]	Values
Rec info. ID	2	0x0027: (Fixed value)
Length	2	0x0008: (Fixed value)
Data	2	Identifier for whether H.264 and H.265 NAL units have Start Code 0x0000: Without Start Code 0x0001: With Start Code (Fixed value)
Reserved	2	0x0000: (Fixed value)

Long-term reference P information

Parameter name	Size [Byte]	Values
Rec info. ID	2	0x0028: (Fixed value)
Length	2	0x0008: (Fixed value)
Data	2	Identifier for P-picture of Long-term reference P 0x0000: Other than below 0x0010: A stream corresponding to the Long-term reference P. AND this GOP does not contain Long-term reference P. 0x0011: A stream corresponding to the Long-term reference P. AND this GOP contains Long-term reference P.
Reserved	2	0x0000: (Fixed value)

* If you always display from IDR, this information does not need consideration.

IDR show/hide information for long-term reference P

Parameter name	Size [Byte]	Values
Rec info. ID	2	0x0029: (Fixed value)
Length	2	0x0008: (Fixed value)
Data	2	Identifier for IDR show/hide of long-term reference P 0x0000: Other than below (Streams that do not include IDR or do not support Long-term reference P, etc.)

		0x0001: IDR to display 0x0002: IDR not to display
Reserved	2	0x0000: (Fixed value)

* Auxiliary information for determining whether to display an IDR picture for a stream containing a long-term reference P. (When long-term reference P video is played back with a specified time and date, if the time of an IDR picture is earlier than the specified time, this IDR picture does not need to be displayed after decoding.)

* If you always display from IDR, this information does not need consideration.

6. Recorder information

6.1. Log information

6.1.1. Get Error Log-list

[URL]

[/cgi-bin/loglist.cgi?UID=<value>&KIND=<value>&HTML=<value>](#)

[Method] GET

Parameter name	Value	Comments
UID	(Numeric)	Issued User ID
KIND	ERR	Fixed value
HTML	as_errorlog.html	Fixed value

Ex. [/cgi-bin/loglist.cgi?UID=7888&KIND=ERR&HTML=as_errorlog.html](#)

[Response]

Items	Value	Comments
FILENAME	as_errorlog.html	Error log information
ERROR_LOG_NO	(Numeric)	Number of Log (Max.1000)
ERROR_LOG	"mmm", "YYYY/M M/DD HH:MM:SS", "x", " yy..y", "z", * Repeat above for number of logs	Log contents mmm: Log number(001-1000) YYYY/MM/DD HH:MM:SS: Time & Date (local time) x: Summertime information (0:OUT, 1:IN) yy..y: Kind of error information(*) z: Time zone(GMT±hh:mm)

* Refer to the Operating Instructions manual of the product for the contents of the error.

[Response example]

```

HTTP/1.1 200 OK[CR][LF]
Connection: Keep-Alive[CR][LF]
Cache-Control: no-cache[CR][LF]
Content-type: text/html[CR][LF]
Content-Length: ****[CR][LF][CR][LF]
FILENAME=as_errorlog.html[CR][LF]
ERROR_LOG_NO=2[CR][LF]
ERROR_LOG="001","2021/11/14 14:10:00","0","CAM 3 COMMUNICATION ERROR","GMT+03:00","002"
,"2021/11/14 14:48:00","0","CAM 3 COMMUNICATION RECOVERED","GMT+03:00"[CR][LF][CR][LF]

```

6.2. HDD information

6.2.1. Get HDD capacity / Remain capacity / Recording period

[URL]

/cgi-bin//cgi-bin/recordedtime.cgi

[Method] GET

[Response]

Items	Value	Comments
Disk	Disk No.	MAIN-n, EXTm-n n:1-9 HDD slot number m:1-5 Extension unit number
Capacity	ccccGB	cccc: HDD capacity [GB]
Remain capacity	rrrrGB	rrrr: HDD remaining capacity [GB]
Recorded time range	YYYY/MM/DD,X, HH:MM:SS,yy/m m/dd,x,hh:mm:s s	Recording period YYYY/MM/DD HH:MM:SS: Oldest time & date (local time) in HDD X: summertime information (0:OUT, 1:IN) yyyy/mm/dd hh:mm:ss: Latest time & date (local time) in HDD x: summertime information (0:OUT, 1:IN)

* Repeat above for number of HDDs. The number of HDDs varies depending on the model.

[Response example]

```
HTTP/1.1 200 OK[CR][LF]
Content-type: text/plain[CR][LF]
Connection: Keep-Alive[CR][LF]
Content-Length: ****[CR][LF][CR][LF]
Recording information[CR][LF][CR][LF]
Disk,Capacity,Remain capacity,Recorded time range[CR][LF]
MAIN-1,4001GB(R),1529GB,2021/11/14,0,13:00:00,2021/12/24,0,15:30:12[CR][LF]
MAIN-2,4001GB,3710GB,,,,,, [CR][LF]
MAIN-3,4001GB,3710GB,,,,,, [CR][LF]
MAIN-4,4001GB,3710GB,,,,,, [CR][LF]
MAIN-5,,,,,, [CR][LF]
.. ..
MAIN-9,,,,,, [CR][LF]
EXT1-1,,,,,, [CR][LF]
EXT1-2,,,,,, [CR][LF]
.. ..
EXT5-8,,,,,, [CR][LF]
EXT5-9,,,,,, [CR][LF]
```