

# WV-S4576LM

12MP Sensor IR In-vehicle 360 Fisheye Network Camera with AI engine

**Edge AI 360-degree fisheye camera that provides video surveillance without any blind spots and business intelligence.**



- 12MP Sensor
- 2992x2992 pixel fisheye images up to 30fps
- Intelligent Auto (with AI Engine)
- Smart Coding (with AI Engine)
- ABF (Auto Back Focus)
- IP66, IK10, 50J compliant, Anti-Condensation System
- Built-in IR LED
- NDAA Compliant



# SPECIFICATIONS

Camera	
Image Sensor	Approx. 1/2 type 12MP CMOS image sensor
Minimum Illumination	Color : 0.3 lx BW : 0.04 lx (F1.9, Maximum shutter : Off (1/30 s), AGC : 11) BW : 0 lx (F1.9, Maximum shutter : Off (1/30 s), AGC : 11, when the IR LED is lit) Color : 0.02 lx BW : 0.003 lx (F1.9, Maximum shutter : max. 16/30s, AGC : 11)
Intelligent Auto	On / Off
Maximum Shutter	max. 16/30s to Max. 1/10000s
Super Dynamic	On / Off, The level can be set in the range of 0 to 31.
Dynamic Range	Max.84 dB (Wide Dynamic Range : On, level : 31)
Image Settings	Gain (AGC), White balance
Image Compensation	Adaptive black stretch, Back light compensation (BLC), Fog compensation, High light compensation (HLC), Digital noise reduction
Color/BW (ICR)	Off / On (IR Light Off) / On (IR Light On) / Auto1 (IR Light Off) / Auto2 (IR Light On) / Auto3 (SCC)
IR LED Light	High* / Middle / Low / Off *Maximum irradiation distance : 14 m{Approx. 45 ft}(30IRE), 10 m {Approx. 33 ft} (Mounting height : Approx. 3 m, Peripheral intensity control : On)
Video Motion Detection (VMD)	On / Off, 4 areas available
Scene Change Detection (SCD)	On / Off, 1 areas available
Audio Detection	On / Off
AI Sound Classification	Gunshot, Yell, Vehicle horn, Glass break
AI Analytics	AI-VMD/AI People Counting for 360-degree fisheye camera, AI Privacy Guard for 360-degree fisheye camera, AI Scene Change Detection, AI Scene Change Detection  For details <a href="https://i-pro.com/global/en/surveillance/products/i-pro-ai-application">https://i-pro.com/global/en/surveillance/products/i-pro-ai-application</a> 3rd party applications are also available. <a href="https://i-pro.com/global/en/surveillance/i-pro-application-platform/application-list">https://i-pro.com/global/en/surveillance/i-pro-application-platform/application-list</a>
Privacy Zone	On / Off, Up to 8 zones available
Camera Title (OSD)	On / Off, Up to 20 characters (alphanumeric characters, marks)
Fixing angle adjustment	-5°, 0°, +5°
Lens	
Zoom Ratio	1x
Digital (Electronic) Zoom	Choose from 3 levels of x1, x2, x4
Focal Length	1.4 mm {1/16 inches}

Maximum Aperture Ratio	1:1.9
Focus Range	0.5 m {19-11/16 inches} - ∞
Angular Field of View	Horizontal : 183° Vertical : 183°

## DORI

Distance to the object in the center of the image	Detect (25 ppm / 8 ppf) : 29.9m / 98.2ft Observe (62.5 ppm / 19 ppf) : 12.0m / 39.3ft Recognize (125 ppm / 38 ppf) : 6.0m / 19.6ft Identify (250 ppm / 76 ppf) : 3.0m / 9.8ft
Coverage radius when mounted at a height of 3 m (10 ft)	Detect (25 ppm / 8 ppf) : 56.1m / 184.2ft Observe (62.5 ppm / 19 ppf) : 20.6m / 67.6ft Recognize (125 ppm / 38 ppf) : 8.4m / 27.6ft Identify (250 ppm / 76 ppf) : 0.3m / 0.9ft

## Browser GUI

Camera Control	Brightness, AUX On / Off
Audio	Mic (Line) Input : On / Off Volume adjustment : Low / Middle / High Audio Output : On / Off Volume adjustment : Low / Middle / High
GUI / Setup Menu Language	English, Italian, French, German, Spanish, Portuguese, Russian, Chinese, Japanese

## Network

Network IF	10Base-T / 100Base-TX, M12 connector
Resolution <Ceiling> <Wall>	<ul style="list-style-type: none"> <li>•Fisheye mode (max. 30 fps/25 fps) 2992×2992 / 2192×2192 / 1280×1280 / 640×640 / 320×320</li> <li>•Quad PTZ mode (max. 15 fps/12.5 fps), Single PTZ mode (max. 15 fps/12.5 fps) 2560×1920 / 2048×1536 / 1600×1200 / 1280×960 / 800×600 / VGA / QVGA</li> </ul>
Resolution <Ceiling>	<ul style="list-style-type: none"> <li>•Double Panorama mode (max. 15 fps/12.5 fps) 2560×1440 / 1920×1080 / 1280×720 / 640×360 / 320×180</li> <li>•Fisheye + Double Panorama mode (max. 15 fps/12.5 fps) (Fisheye) 2992×2992 / 2192×2192 / 1280×1280 / 640×640 / 320×320 (Double Panorama) 1280×720 / 640×360 / 320×180</li> <li>•Fisheye + Quad PTZ mode (max. 15 fps/12.5 fps) (Fisheye) 2992×2992 / 2192×2192 / 1280×1280 / 640×640 / 320×320 (Quad PTZ) 1280×960 / 800×600 / VGA / QVGA</li> <li>•Quad streams mode (Single PTZ (Quad streams)) 1280×960 / 800×600 / VGA / QVGA (max. 15 fps/12.5 fps) (Quad PTZ) 2560×1920 / 2048×1536 / 1600×1200 / 1280×960 / 800×600 / VGA / QVGA (max. 5 fps)</li> </ul>
Resolution <Wall>	<ul style="list-style-type: none"> <li>•Panorama mode (max. 15 fps/12.5 fps) 2560×1440 / 1920×1080 / 1280×720 / 640×360 / 320×180</li> <li>•Fisheye + Panorama mode (max. 15 fps/12.5 fps) (Fisheye) 2992×2992 / 2192×2192 / 1280×1280 / 640×640 / 320×320 (Panorama) 1280×720 / 640×360 / 320×180</li> </ul>
H.265/H.264	[Transmission Mode] Constant bit rate / VBR / Frame rate / Best effort [Transmission Type] Unicast port (AUTO) / Unicast port (MANUAL) / Multicast
JPEG	[Image Quality] 10 steps
Smart Coding	GOP (Group of pictures) control : On (Frame rate control)* / On (Advanced)* / On (Mid) / On (Low) / Off *On (Frame rate control) and On (Advanced) are only available with H.265. Auto VIQS : On / Off
Audio Compression	G.726 (ADPCM) : 16 kbps / 32 kbps G.711 : 64 kbps AAC-LC : 64 kbps / 96 kbps / 128 kbps

Supported Protocol	IPv6 : TCP/IP, UDP/IP, HTTP, HTTPS, SSL/TLS, SMTP, DNS, NTP, SNMP v1/v2/v3, DHCPv6, RTP, MLD, ICMP, ARP, IEEE 802.1X, DiffServ IPv4 : TCP/IP, UDP/IP, HTTP, HTTPS, SSL/TLS, RTSP, RTP, RTP/RTCP, SMTP, DHCP, DNS, DDNS, NTP, SNMP v1/v2/v3, UPnP, IGMP, ICMP, ARP, IEEE 802.1X, DiffServ, SRTP
Maximum concurrent accessnumber	Up to 14 users (Depends on network conditions)
Secure	Device Certificate GlobalSign® pre-installed, User authentication, Host authentication, HTTPS, 802.1X Support, Data encryption
SDXC/SDHC/SD Memory Card (Option)	H.265 / H.264 recording : Manual REC / Alarm REC (Pre/Post) / Schedule REC / JPEG recording : Manual REC / Alarm REC (Pre/Post) Compatible SDXC/SDHC/SD card : 2 GB, 4 GB*, 8 GB*, 16 GB*, 32 GB*, 64 GB**, 128 GB**, 256 GB**, 512GB**model *SDHC card, ** SDXC card (except miniSD card and microSD card)
Mobile Terminal Compatibility	iPad / iPhone Android™ terminals
ONVIF Profile	G / M / S / T

### Alarm

Alarm Source	3 terminals input, VMD, Command alarm
Alarm Actions	SDXC/SDHC/SD memory recording, E-mail notification, HTTP alarm notification, Indication on browser, TCP alarm notification output

### Input/Output

Monitor output (for adjustment)	VBS : 1.0 V [p-p] / 75 Ω, composite, ø3.5 mm mini jack An NTSC or PAL signal can be outputted from camera
Audio Input	[For microphone] ø3.5 mm stereo mini jack, Recommended applicable microphone : Plug-in power type (Sensitivity of microphone : -48 dB ±3 dB (0 dB=1 V / Pa,1 kHz)) Input impedance : Approx. 2 kΩ (unbalanced) Supply voltage : 2.5 V ±0.5 V [For line] Input level : Approx. -10 dBV
Audio Output	ø3.5 mm stereo mini jack (monaural output) Output impedance : Approx. 600 Ω (unbalanced) Output level : -20 dBV
External I/O Terminals	ALARM IN1 (Alarm input 1/ Black & white input/ Auto time adjustment input) (x1) ALARM IN2 (Alarm input 2/ ALARM OUT) (x1) ALARM IN3 (Alarm input 3/ AUX OUT) (x1)

### General

Safety	UL (UL62368-1), c-UL (CSA C22.2 No.62368-1), CE, IEC62368-1
EMC	FCC (Part15 ClassA), ICES003 ClassA, EN55032 ClassB, EN55024, EN55035 ECE-R10, EN50498 compliant, EN50121
Power Source and Power Consumption	DC power supply : DC 12 V 1.1 A/Approx. 13.2 W , PoE (IEEE802.3af compliant, Alternative A) Device : DC 48 V 270 mA/Approx. 12.95 W (Class 0 device)
Ambient Operating Temperature	IR LED : On -40 °C to +50 °C (-40 °F to 122 °F) / Off -40 °C to +60 °C (-40 °F to 140 °F)
Ambient Operating Humidity	10 to 100 % (no condensation)
Anti-Condensation System	Rosahl element
Water and Dust Resistance	IP66(IEC60529), Type 4X(UL50), NEMA 4X compliant
Shock Resistance	50J (IEC 60068-2-75 compliant), IK10 (IEC 62262)
Wind Resistance	Up to 40 m/s {approx. 89 mph}
Railway Application	EN45545 compliant, EN50155-TX

Dimensions	When using the attachment plate only : $\varnothing 154 \text{ mm} \times 60.3 \text{ mm (H)}$ { $\varnothing 6\text{-}1/16 \text{ inches} \times 2\text{-}3/8 \text{ inches (H)}$ } Dome radius 35 mm {1-3/8 inches}
Mass (Approx.)	When using the attachment plate only : Approx. 880 g {1.94 lbs}
Finish	Main body : Aluminum die cast, i-PRO white Outer fixing screws : Stainless steel (Corrosion-resistant treatment) Dome section : Polycarbonate resin, Clear

## NOTES

### Important

- Safety Precautions : Carefully read the Basic Information, Installation Guide and Operating Instructions before using this product.
- i-PRO Co., Ltd. cannot be held responsible for the performance of the network and/or other manufacturers' products used on the network.
- Masses and dimensions are approximate. Specifications are subject to change without notice.

### Trademarks and registered trademarks

- iPad and iPhone are trademarks of Apple Inc., registered in the U.S. and other countries. - Android is a trademark of Google LLC.
- ONVIF is a trademark of ONVIF, Inc.
- All other trademarks identified herein are the property of their respective owners

©i-PRO Co., Ltd All rights reserved / March 2023

## Bundled License

### AI-VMD/AI People Counting with the 360-degree fisheye camera

#### AI Video Motion Detection

- AI differentiates between vehicles and people, detecting and sending warning notifications when an intruder enters a specified area.
- Intruder detection:** Issues an alarm when a moving object enters a specified area.
- Cross Line detection:** Issues an alarm when an object moving in the specified direction crosses a specified threshold.
- Loitering detection:** Issues an alarm when a moving object enters a specified area and stays there for a specified amount of time.



#### People Counting

- Cross Line Counting:** Counts the number of people moving in a specified direction and cross a specified threshold.
- Area Counting (Queue Management):** Counts the number of people in the set area.

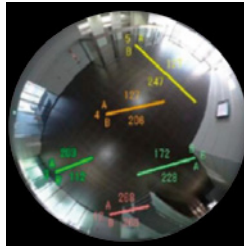

Cross Line Counting

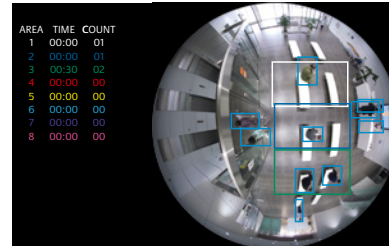

Area Counting

#### Heat map

- Heat mapping provides statistical information about traffic flow and keeps counts for people passing through and loitering in the area.

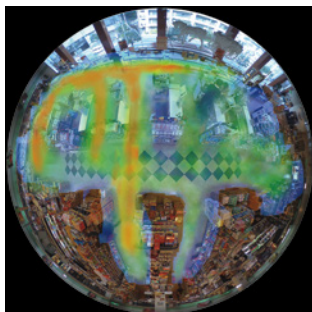

Passing



Loitering

#### Occupancy detection

- The network camera uses its AI engine to detect congestion, providing data that can be used to direct visitor traffic flow in advance or help staff work more efficiently.

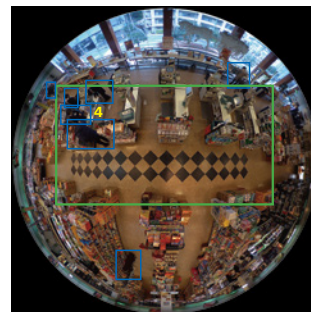

### AI Privacy Guard for 360-degree fisheye

#### AI Privacy Guard

- AI can automatically mosaic faces and figures of people who are photographed to safeguard privacy and portrait rights.

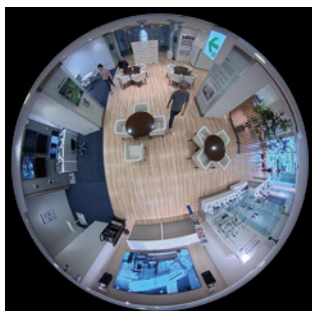

Original image



Processed image

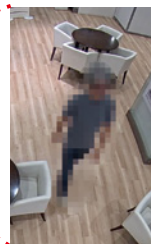

### i-PRO Active Guard

- The i-PRO Active Guard stores the best images and metadata captured by i-PRO network cameras, then collates this data with the watch list registered in the client software and issues an alarm when a match is found. The server does not require expensive hardware because i-PRO network cameras handle the advanced processing. The server can even be installed on the same hardware as the VMS. The system comprises the i-PRO Active Guard, the AI application installed on i-PRO network cameras utilizing AI engines, and i-PRO Active Guard Plug-in software for the VMS client.

#### Example of basic system connection (without i-PRO Active Guard)

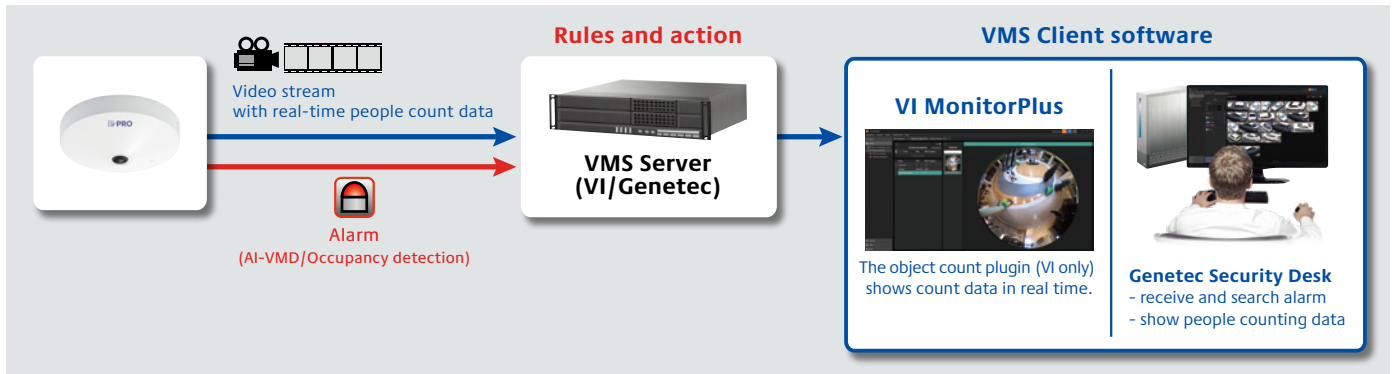

#### Example of basic system connection (with i-PRO Active Guard) for Video Insight/Genetec

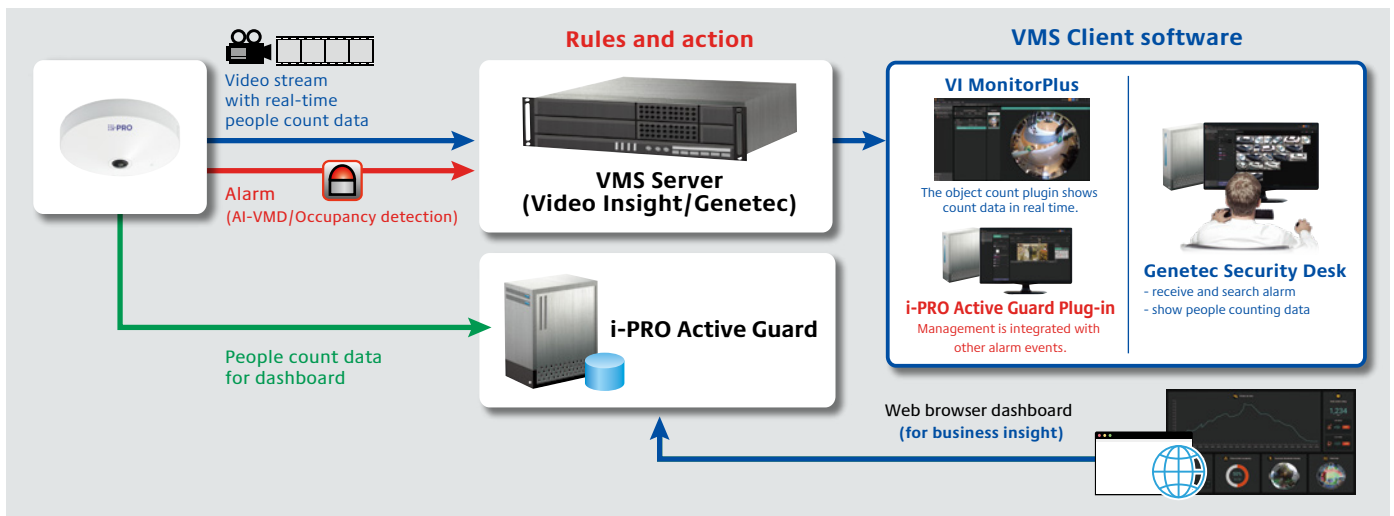

\*VMS Server and i-PRO Active Guard can be installed on the same server.

#### Example of basic system connection for WV-ASM300W/Network disk recorder

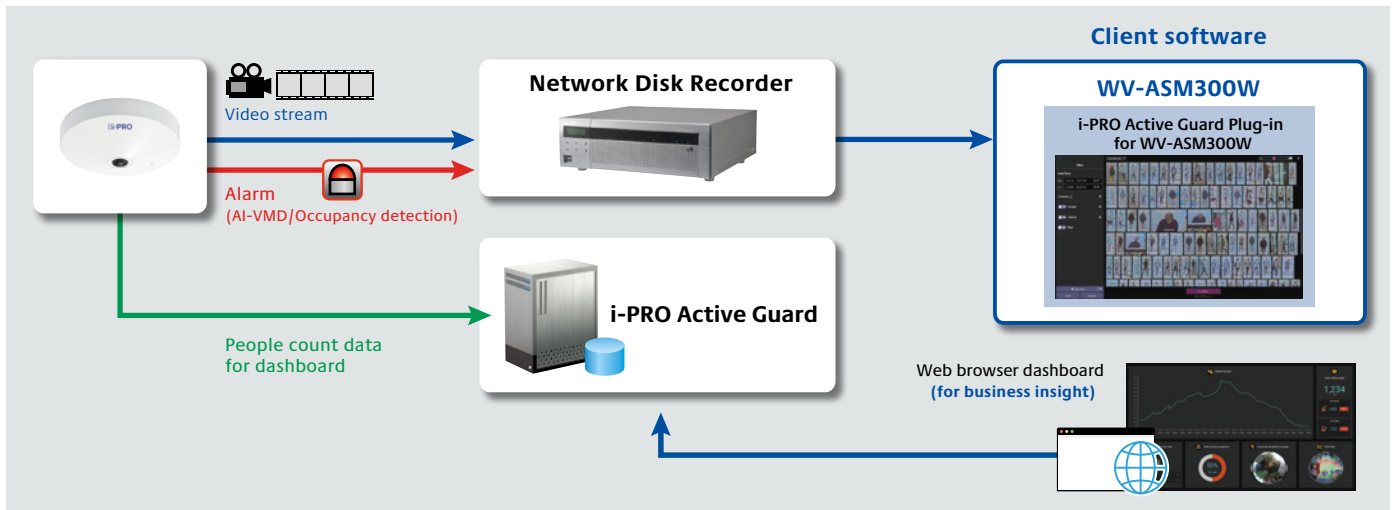

## OPTIONAL ACCESSORIES

Select a compatible accessory

[Accessory Selector \(i-pro.com\)](http://i-pro.com).



WV-QWL500-W  
Mount Bracket



WV-QJB500-W  
Mount Bracket



WV-QSR501-W  
Mount Bracket



WV-QWL501-W  
Mount Bracket



WV-QPL500-W  
Mount Bracket



PAPM4W  
Pole Mount Bracket



WV-QCN500-W  
Mount Bracket

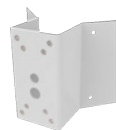

PACA4W  
Corner Mount Adapter  
Bracket



WV-QCL501-W  
Mount Bracket



WV-QCL100-W  
Mount Bracket



WV-QCL101-W  
Mount Bracket



WV-QCL102-W  
Universal Camera  
Mount Bracket



WV-QLR100-W  
Light Rail Mount  
Bracket



WV-Q105A  
Mount Bracket

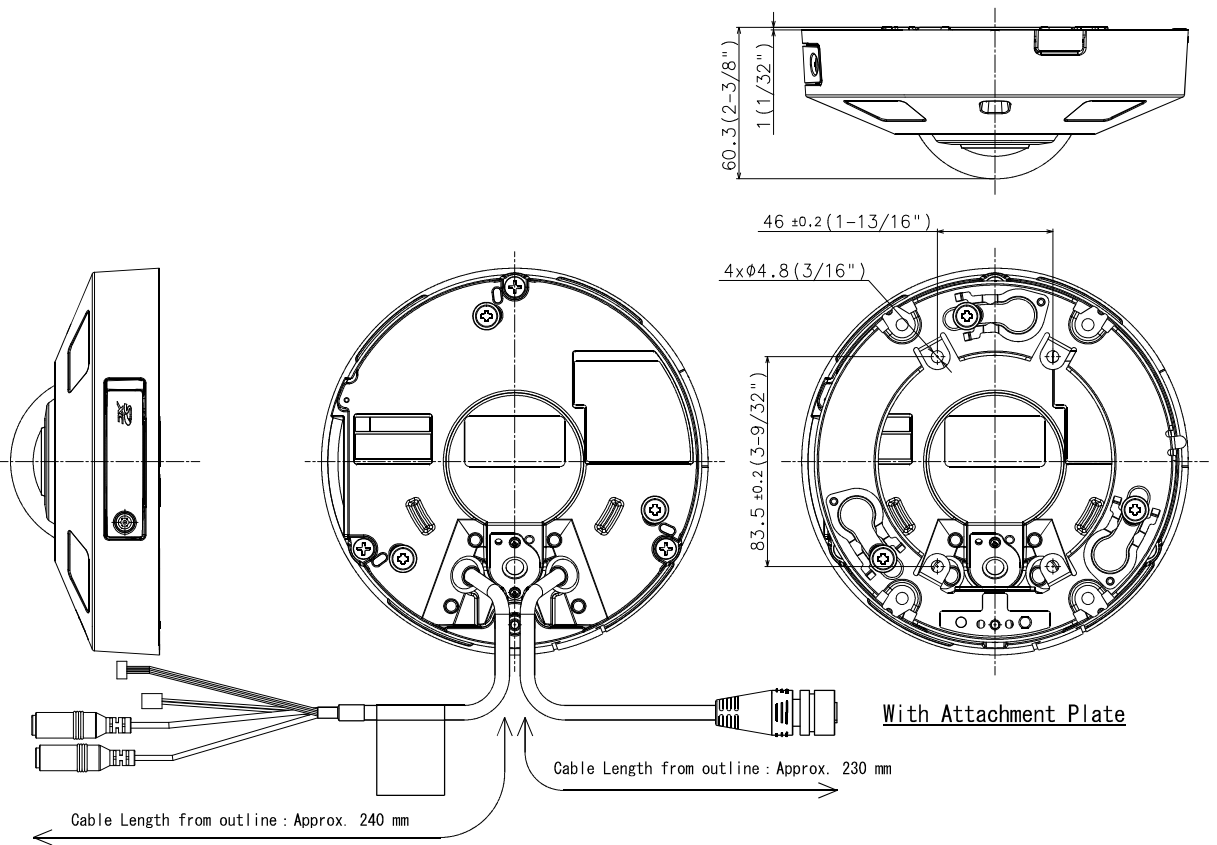
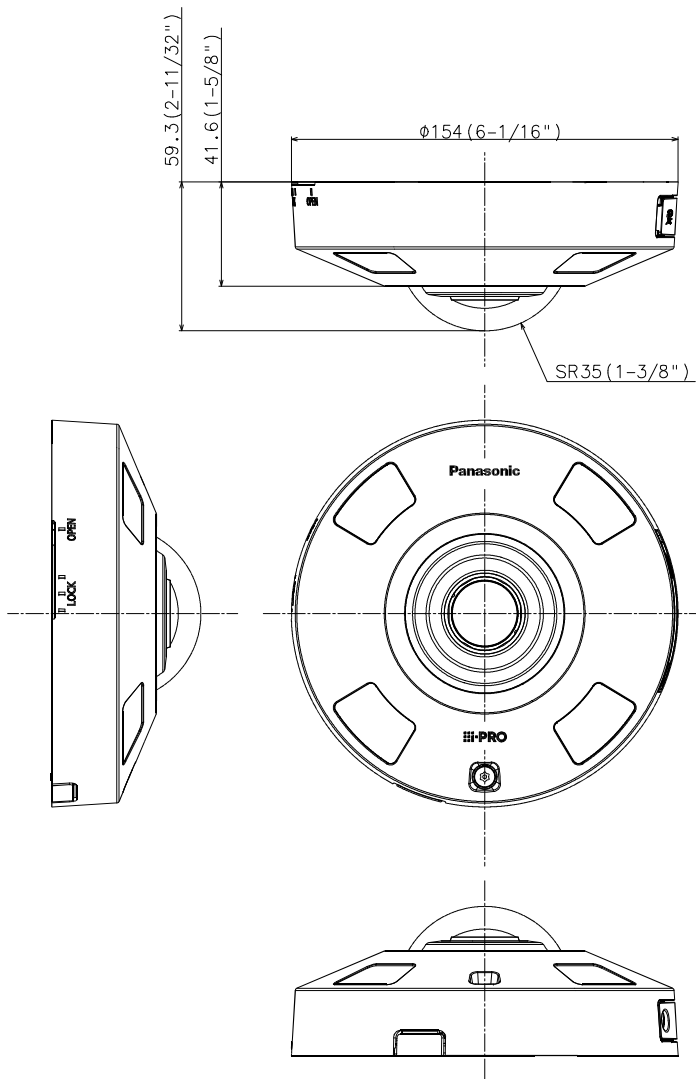

侧面図/Side-view	投影面積/Projected area
	0.007 (m <sup>2</sup> )

Mass : Approx. 880 g {1.94 lbs} (When using the attachment plate)

WV-S4576LM