



HDD Compatibility Chart

Version : 3rd March 2023

CONTENTS

For WJ-NU series

Important Notes 2

HDD Compatibility Chart 5

For WJ-NX series and others

Important Notes 7

To use Seagate, WD (5TB or 6TB) HDD with HDD canister 7

The preparations to use Seagate HDD 8

HDD Compatibility Chart (*) 17

SSC setting procedure 27

Common information

Recorder Maintenance Guide 32

(*) For models that have been discontinued for more than 7 years, the compatibility chart will be deleted.

*Removed compatibility tables for WJ-RT416 series and WJ-HD300 series (Version : 31 Mar, 2022)

Important Notes (WJ-NUxxx series)

Installation of the HDD(s) for [WJ-NU301](#) (from Installation Guide)

Step 1

Unplug the Power cord from the recorder's Power cord inlet.

Step 2

Remove the 4 screws on the left and right sides of this product, remove the 1 screw on the top cover, remove the 1 screw on the middle upper part of the back, and then remove the top cover.

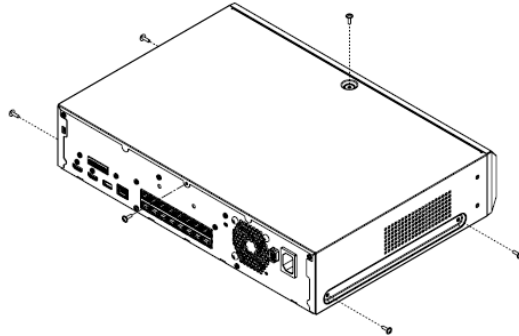

Step 3

Clip the top of the hook on the HDD HOLDER TOP with your finger and thumb. Push inward with your thumb to release the hook, and open the HDD HOLDER TOP.

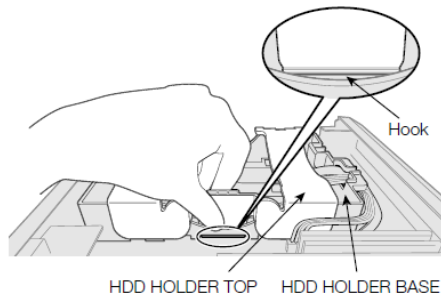

Step 4

Remove the AIR CAP that protects the cable connector.

Step 5

Tilt the HDD at an angle and insert the cable connected to the board into the HDD.

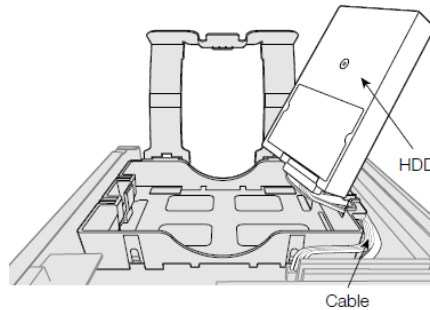

Step 6

Make sure that the cable passes through the HDD HOLDER BASE slot so that they do not come apart, and place the HDD with the cable plugged in on the HDD HOLDER BASE. If the cable is not threaded through the slot, pass it through before placing the HDD.

Pass the cable through the HDD HOLDER BASE slot.

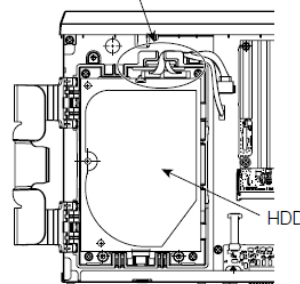

Note:

For WJ-NU301, the position of the cable connector on the board side is different.

Step 7

Pass the hook of the HDD HOLDER TOP through the inside of the HDD HOLDER BASE. Push in the arrow on the HDD HOLDER TOP, close the HDD HOLDER TOP, and then fix the HDD.

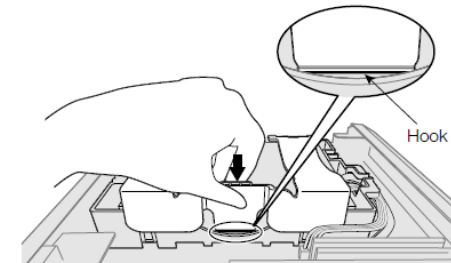

Step 8

Perform Step 3 to Step 7 for another HDD, and install the HDD.

Step 9

Reinstall the top cover, and fix it by tightening the 4 screws on the left and right sides of this product, 1 screw on the top cover, and 1 screw on the middle upper part of the back.

Important Notes (WJ-NUxxx series)

Installation of the HDD for [WJ-NU300/NU201/NU101](#) (from Installation Guide)

Step 1

Unplug the DC plug of the AC power adapter from the DC jack of the recorder.

Step 2

Remove the two screws on the left and right sides of the main unit, remove the three screws on the back, and then remove the top cover.

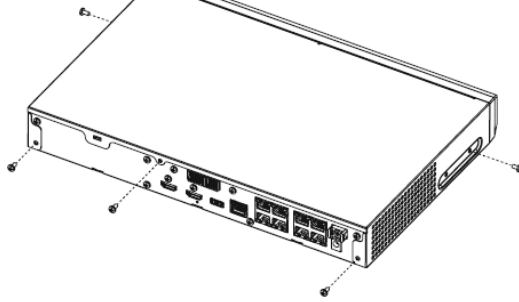

Step 3

Clip the top of the hook on the HDD HOLDER TOP with your finger and thumb. Push inward with your thumb to release the hook, and open the HDD HOLDER TOP.

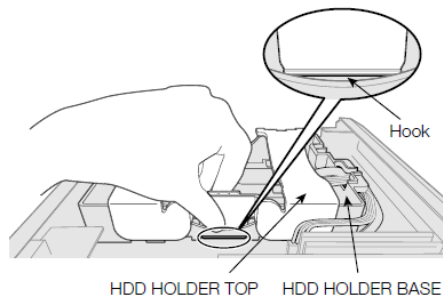

Step 4

Remove the AIR CAP that protects the cable connector.

Step 5

Tilt the HDD at an angle and insert the cable connected to the board into the HDD.

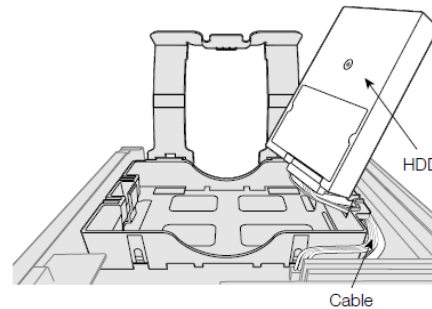

Step 6

Make sure that the cable passes through the HDD HOLDER BASE slot so that they do not come apart, and place the HDD with the cable plugged in on the HDD HOLDER BASE. If the cable is not threaded through the slot, pass it through before placing the HDD.

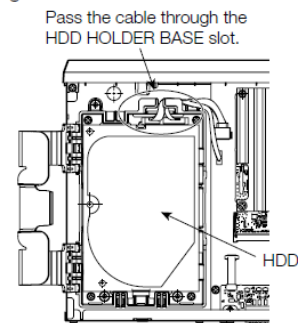

Step 7

Pass the hook of the HDD HOLDER TOP through the inside of the HDD HOLDER BASE. Push in the arrow on the HDD HOLDER TOP, close the HDD HOLDER TOP, and then fix HDD.

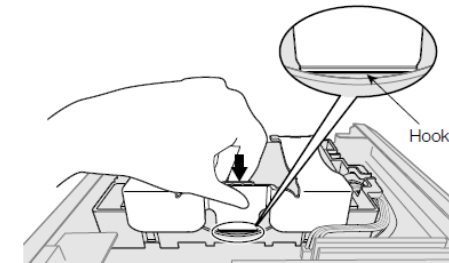

Step 8

Install the top cover as before, and tighten the two screws on the left and right sides of the main unit, and the three screws on the back to secure it.









Important Notes (WJ-NUxxx series)

There are two height types of HDD,
 one is normal height (26.1mm / 1.028"),
 the other is low profile (20.2mm / 0.795").

If you will change HDD from normal height to low profile, you shall also change top cover of HDD holder.

No need to change top cover of HDD holder,
 if you will change from low profile HDD to normal height one,
 or HDD height is the same before and after.

We recommend you changing HDD as the same height one before.

before		after	
<p>Normal height HDD</p> 	<p>Low profile HDD</p> 		<p>Need Service part # PGUX2500ZA/C1 (ask i-PRO service section)</p>
<p>Low profile</p> 	<p>Normal height</p> 	<p>(No need for another part)</p>	
<p>Normal height</p> 	<p>Normal height</p> 	<p>(No need for another part)</p>	
<p>Low profile</p> 	<p>Low profile</p> 	<p>(No need for another part)</p>	

HDD Compatibility Chart

WJ-NU301



30th November 2022

Latest Firmware Version : V1.10

Current HDDs

Capacity	Vendor	Model	Height	Note
20TB	Seagate	ST20000VE002	Normal	NU301 should be operated more than 5°C (41°F) with this drive.
18TB	Western Digital	WD181PURP-74B6HY0	Normal	*1
		WD181PURP-85B6HY0		
8TB	Seagate	ST8000VX010	Normal	
	Western Digital	WD84PURZ-74B2YY0 WD84PURZ-85B2YY0	Normal	*1
6TB	Seagate	ST6000VX009	Normal	
	Western Digital	WD64PURZ-74BWUY0 WD64PURZ-85BWUY0	Normal	*1
4TB	Seagate	ST4000VX016	Low profile	
	Western Digital	WD43PURZ-74BWPY0 WD43PURZ-85BWPY0	Normal	*1
3TB	Seagate	ST3000VX015	Low profile	
	Western Digital	WD30PURZ-74AKKY0 WD30PURZ-85AKKY0	Normal	*1
2TB	Seagate	ST2000VX017	Low profile	
	Western Digital	WD22PURZ-74B4ZY0 WD22PURZ-85B4ZY0	Normal	*1
1TB	Seagate	ST1000VX013	Low profile	

Discontinued HDDs

Capacity	Vendor	Model	Height	Note
6TB	Western Digital	WD63PURZ-74B4VY0	Normal	Discontinued in Q1 CY2023
		WD63PURZ-85B4VY0		*1
4TB	Western Digital	WD42PURZ-74B4YY0	Normal	Discontinued in Q1 CY2023
		WD42PURZ-85B4YY0		*1

*1 The difference between "-74" and "-85" depends on the WD sales route.

HDD Compatibility Chart

WJ-NU300/NU201/NU101



30th November 2022

Latest Firmware Version : V1.10

Current HDDs

Capacity	Vendor	Model	Height	Note
20TB	Seagate	ST20000VE002	Normal	NU101/201/300 should be operated more than 5°C (41°F) with this drive.
18TB	Western Digital	WD181PURP-74B6HY0 WD181PURP-85B6HY0	Normal	*1
8TB	Seagate Western Digital	ST8000VX010 WD84PURZ-74B2YY0 WD84PURZ-85B2YY0	Normal	*1
6TB	Seagate Western Digital	ST6000VX009 WD64PURZ-74BWUY0 WD64PURZ-85BWUY0	Normal	*1
4TB	Seagate Western Digital	ST4000VX016 WD43PURZ-74BWPY0 WD43PURZ-85BWPY0	Low profile Normal	*1
3TB	Seagate Western Digital	ST3000VX015 WD30PURZ-74AKKY0 WD30PURZ-85AKKY0	Low profile Normal	*1
2TB	Seagate Western Digital	ST2000VX017 WD22PURZ-74B4ZY0 WD22PURZ-85B4ZY0	Low profile Normal	*1
1TB	Seagate	ST1000VX013	Low profile	

Discontinued HDDs

Capacity	Vendor	Model	Height	Note
6TB	Western Digital	WD63PURZ-74B4VY0 WD63PURZ-85B4VY0	Normal	Discontinued in Q1 CY2023 *1
4TB	Western Digital	WD42PURZ-74B4YY0 WD42PURZ-85B4YY0	Normal	Discontinued in Q1 CY2023 *1

*1 The difference between "-74" and "-85" depends on the WD sales route.

Important Notes

Caution : To use Seagate, WD (5TB, 6TB or 8TB) HDD with HDD canister
for WJ-NX400K/WJ-HXE400/WJ-ND400K/WJ-HDE400/WJ-HD716K/WJ-HD616K

Please **DO NOT** fix two screws into bottom side of HDD (➡ marks below),
because screw length is longer than depth of tapped hole .



Important Notes

Important information : The preparations to use Seagate HDD

(For WJ-NX400K/WJ-HXE400/WJ-NX300K/WJ-NX200K/WJ-ND400K/WJ-HDE400/WJ-HD716K/WJ-HD616K)

To use Seagate HDD, the following 2 items **must** be performed before the installation of HDDs.

1. Turn off SSC (SSC : Spread Spectrum Clocking, default setting : "ON")

Caution : If SSC is NOT turned off, the disk will **never be recognized by NVR**.

⇒ [See Next Page](#)

2. Choose the screw to use

Caution : If do not install the correct screws, the HDD will not be properly secured to the case, and may experience HDD errors or malfunction.

The screws to install the HDD depend on the serial number of the NVR.

⇒ [See Page 10](#)

Caution :

We will not take responsibility for any failure that occurs by performing an operation different from the detailed procedure from the next pages.

Important Notes

The preparations to use Seagate HDD

1) The items and procedure to turn off SSC

◆ The required items

- Windows PC with "SeaChest utilities" *1
- USB to SATA conversion adapter for 3.5 inch HDD with AC power input
Note : Adapter with special functions such as clone function cannot be used.
- HDDs to be changed

*1: the download site of "SeaChest Utilities"

<https://www.seagate.com/support/software/seachest/>

◆ Procedure to turn off SSC setting

Described on page 27 to 31

⇒ [See Page 27](#)

Important Notes

The preparations to use Seagate HDD

2) Choose the screws

◆ The screws to install the HDD differ depending on the serial No. of the NVR.

Ex.) Serial No. : TLV00001

(1st character =year(T:2020), 2nd character =month(L:Dec)

		Serial No(example)											
1st character	year	R	S	T	U	V	W	X	Y	A	B	C	D
		2018	2019	2020	2021	2022	2023	2024	2025	2026	2027	2028	2029
2nd character	month	A	B	C	D	E	F	G	H	I	J	K	L
		Jan	Feb	Mar	Apr	May	Jun	Jul	Aug	Sep	Oct	Nov	Dec

【 Case 1 】 : Serial No. is TLxxxxxx or later
(1st character T=2020, 2nd character L =Dec)

⇒ See page 11 to 13

【 Case 2 】 : Serial No. is TKxxxxxx or earlier
(1st character T=2020, 2nd character K =Nov)

⇒ See page 14 to 16

Important Notes

The preparations to use Seagate HDD / Choose the screws 【 Case 1 】

Screw/Washer List 【 Case 1 : TL*xxxxx or later 】

Screw No	Screw or washer	type	color	quantity			Standard Accessories	
				WJ-NX400K WJ-HXE400	WJ-NX300K	WJ-NX200K		
①	Screw	#6-32UNC L=5.3 mm	Silver	6pcs x 9HDDs *1	4pcs x 4HDDs	4pcs x 2HDDs	YES	<p>Provided with NVR</p> <p>*1 Use 36 (4pcs X 9HDDs) screws to install Seagate HDDs and WD 5TB/6TB HDDs.</p> <p>Use 54 (6pcs X 9HDDs) screws to install other WD HDDs except for 5TB/6TB.</p>



Important Notes

The preparations to use Seagate HDD / Choose the screws < Case 1 >

Installation of the HDD for [WJ-NX400K/WJ-HXE400](#) < Case 1 : TL*xxxxx or later >

Install the HDD into the HDD Unit using 4 fixing screws (Screw No.①)

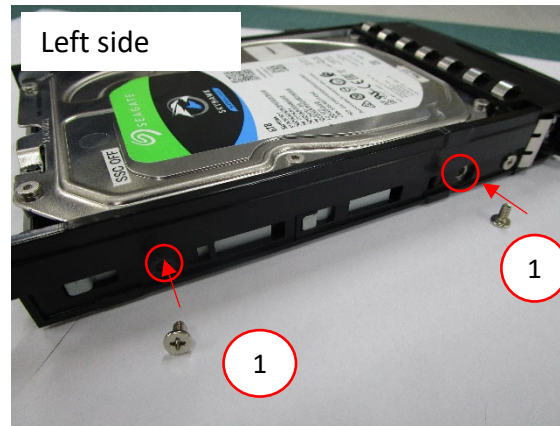
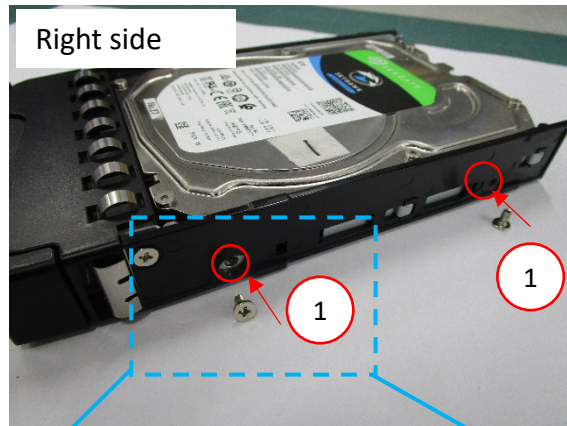

Do not fix the two places on bottom with screws

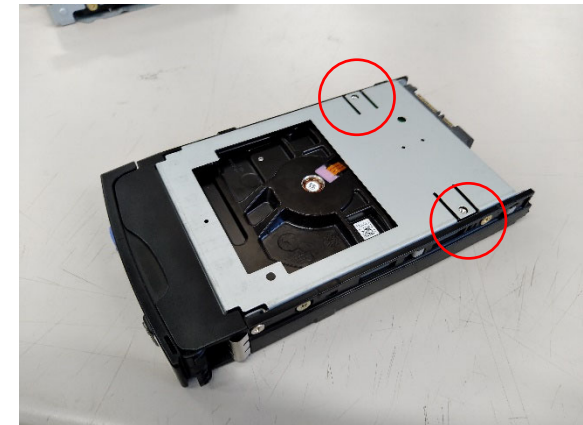

Important Notes

The preparations to use Seagate HDD / Choose the screws < Case 1 >

Installation of the HDD for [WJ-NX300K/WJ-NX200](#) < Case 1 : TL*xxxxx or later >

Install the HDD into the bracket using 4 fixing screws (Screw No.①)

WJ-NX200's bracket and WJ-NX300's bracket are partly different, but the assembly work is the same .

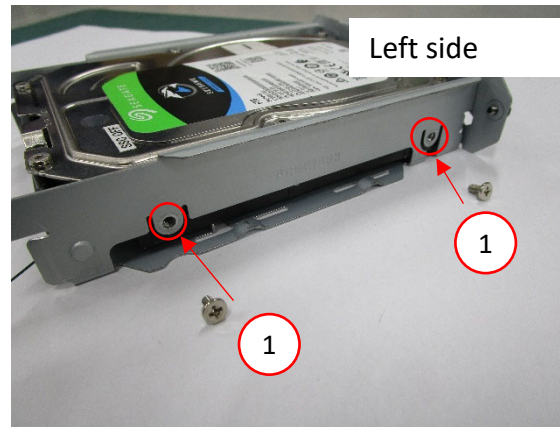
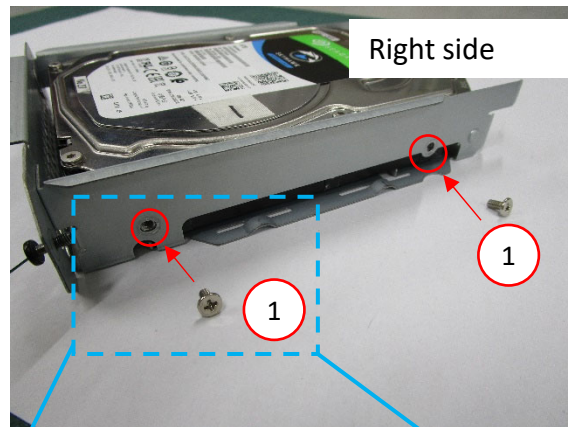

Important Notes

The preparations to use Seagate HDD / Choose the screws < Case 2 >

Screw/Washer List < Case 2 : TK*xxxxx or earlier >

Screw No	Screw or washer	type	color	quantity				Standard Accessories	
				WJ-NX400K WJ-HXE400 WJ-ND400K WJ-HDE400	WJ-NX300K	WJ-NX200K	WJ-HD716K WJ-HD616K (WJ-HDU40K)		
②	Screw	#6-32UNC L=6 mm	Gold	6pcs x 9HDDs *1	4pcs x 4HDDs	4pcs x 2HDDs	6pcs x 4HDDs *2	YES	<p>Provided with NVR</p> <p>*1 Use 36 (4pcs X 9HDDs) screws to install Seagate HDDs and WD 5TB/6TB HDDs. Use 54 (6pcs X 9HDDs) screws to install other WD HDDs except for 5TB/6TB.</p> <p>*2 Use 16 (4pcs X 4HDDs) screws to install Seagate HDDs and WD 5TB/6TB HDDs. Use 24 (6pcs X 4HDDs) screws to install other WD HDDs except for 5TB/6TB.</p>
③	washer	M4 spring washer	-	2pcs x 9HDDs	4pcs x 4HDDs	4pcs x 2HDDs	2pcs x 4HDDs	NO	Locally procured

Screw No.③ (spring washer) spec

Spring Washer	d(mm)		b(mm)	t(mm)	D(mm)	Material
	max	min	min	min	Max	
4 (For M4)	4.5	4.1	1.4	1	7.6	SUS

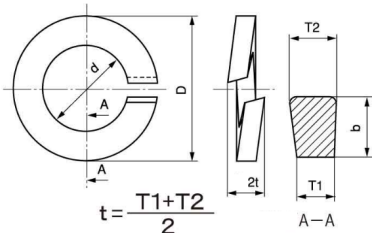

Important Notes

The preparations to use Seagate HDD / Choose the screws < Case 2 >

Installation of the HDD for [WJ-NX400K/WJ-HXE400/WJ-ND400/WJ-HDE400/WJ-HD716/WJ-HD616](#) < Case 2 : TK*xxxxx or earlier >

Install the HDD into the HDD Unit using 2 fixing screws (②), A and B places

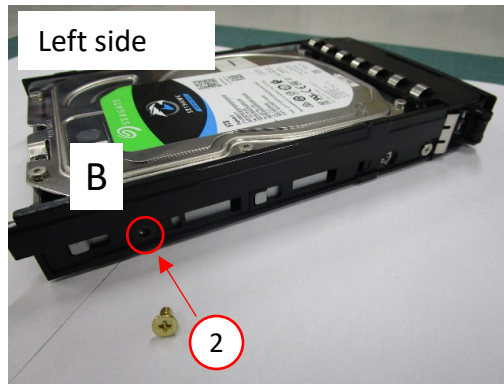
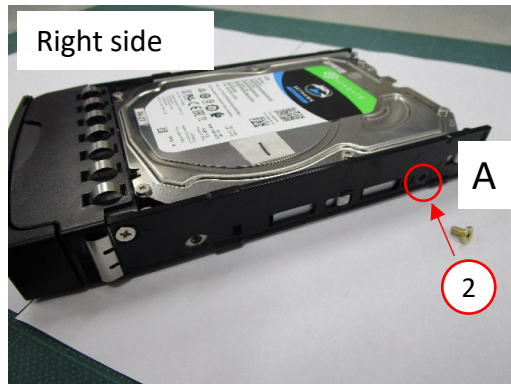

Do not fix the two places on bottom with screws

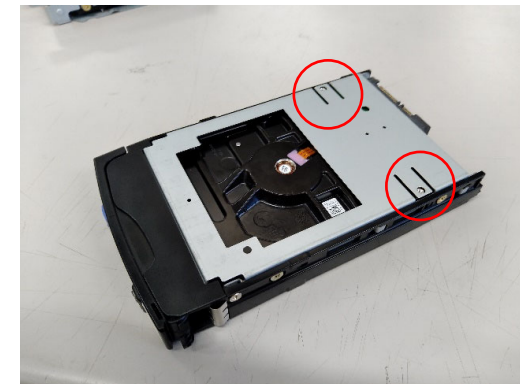

C and D places, fix with 2 washers (③) and 2 screws (②)

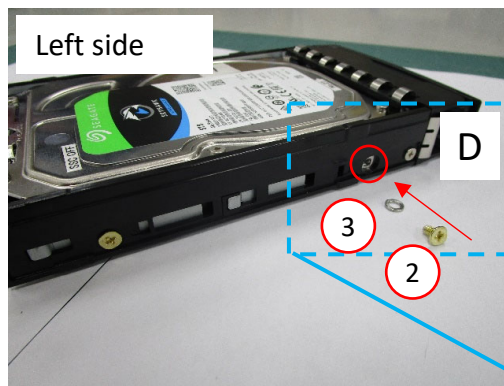
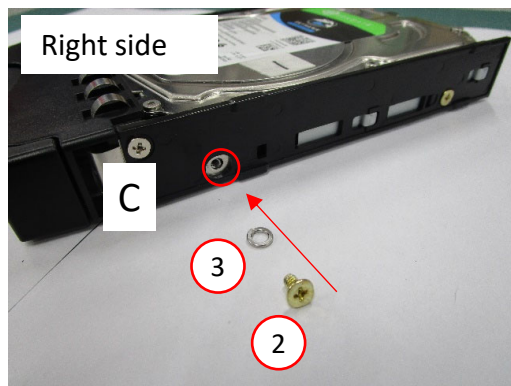

Important Notes

The preparations to use Seagate HDD / Choose the screws < Case 2 >

Installation of the HDD for [WJ-NX300K/WJ-NX200](#) < Case 2 : TK*xxxxx or earlier >

Install the HDD into the bracket using 4 washers (③) and 4 fixing screws (②)

WJ-NX200's bracket and WJ-NX300's bracket are partly different, but the assembly work is the same .

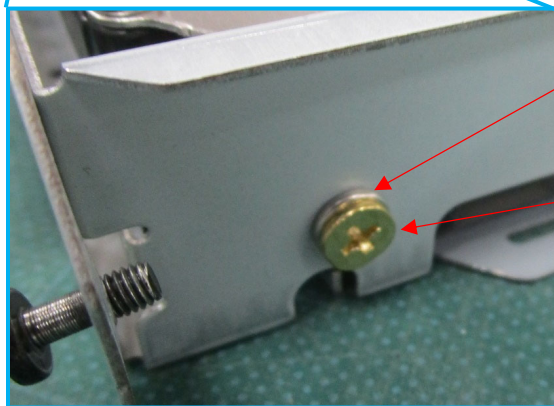
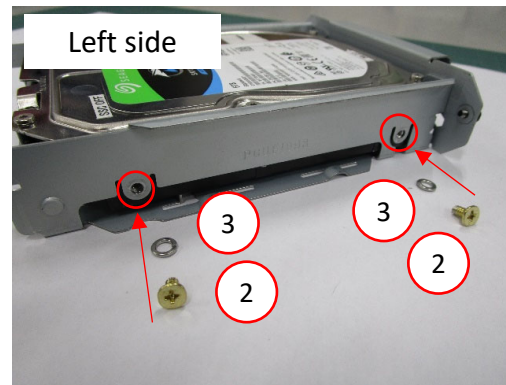
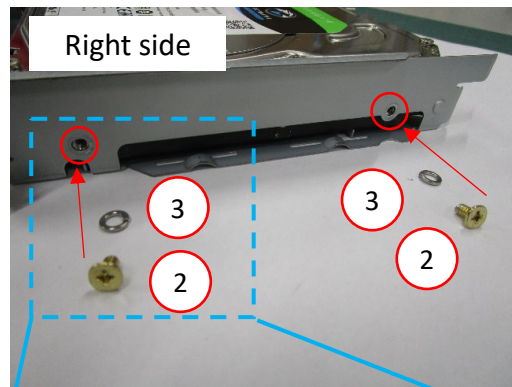

Washer③

Screw②

HDD Compatibility Chart

WJ-NX400K
WJ-HXE400



3rd March 2023

3.5" SATA – Advanced Format

Latest Firmware Version : V5.20 (NX400)
V1.11 (HXE400)

Current HDDs

Discontinued HDDs

Capacity	Vendor	Model	Note
8TB	Western Digital	WD84PURZ-74B2YY0	*1, *2
		WD84PURZ-85B2YY0	
6TB	Western Digital	WD64PURZ-74BWUY0	*1, *2
		WD64PURZ-85BWUY0	
	Seagate	ST6000VX001	*2, *3
		WD62PURZ-74B3AY0	*1, *2
4TB	Western Digital	WD43PURZ-74BWPY0	*1
	Seagate	ST4000VX016	*3
3TB	Western Digital	WD33PURZ-74BWPY0	*1
		WD33PURZ-85BWPY0	
		WD30PURZ-74AKKY0	*1
2TB	Western Digital	WD30PURZ-85AKKY0	
		WD22PURZ-74B4ZY0	*1
		WD22PURZ-85B4ZY0	

Capacity	Vendor	Model	Note
6TB	Western Digital	WD60EFRX-68MYMN1	*2
		WD60EFRX-68L0BN1	*2
		WD60PURX-64T0ZY0	*2
		WD60PURX-64T0ZY1	*2
		WD60PURZ-85ZUFY1	*2
		WD63PURZ-74B4VY0	Discontinued in Q1 CY2023
		WD63PURZ-85B4VY0	*1
		WD50EFRX-68MYMN1	*2
		WD50EFRX-68L0BN1	*2
		WD50PURX-64T0ZY0	*2
5TB	Western Digital	WD40PURX-64GVNY0	
		WD40PURX-64NZ6Y0	
		WD40PURZ-85TTDY0	
		WD40EFRX-68WT0N0	
4TB	Western Digital	WD40PURZ-74AKKY0	*1
		WD40PURZ-85AKKY0	
		WD42PURZ-74B4YY0	Discontinued in Q1 CY2023
		WD42PURZ-85B4YY0	*1

Capacity	Vendor	Model	Note
3TB	Western Digital	WD30PURX-64P6ZY0	
		WD30PURZ-85GU6Y0	
		WD30EFRX-68EUZNO	
2TB	Western Digital	WD20PURX-64P6ZY0	
		WD20PURZ-85GU6Y0	
		WD20EFRX-68EUZNO	
		WD20PURZ-74AKKY0	*1
		WD20PURZ-85AKKY0	

*1 The difference between "-74" and "-85" depends on the WD sales route.

*2 Please refer to page 2, not to fix two screws into bottom side of HDD.

*3 To use Seagate SkyHawk series, it is necessary to set the HDD SSC setting to "OFF" in advance. And need to choose the screws to install the HDDs. Please refer to page 3 for instructions.

HDD Compatibility Chart

WJ-NX300K
WJ-HXE400



3rd March 2023

3.5" SATA – Advanced Format

Latest Firmware Version : V5.20 (NX300)
V1.11 (HXE400)

Current HDDs

Capacity	Vendor	Model	Note
8TB	Western Digital	WD84PURZ-74B2YY0	*1, *2
		WD84PURZ-85B2YY0	
6TB	Western Digital	WD64PURZ-74BWUY0	*1, *2
		WD64PURZ-85BWUY0	
	Seagate	WD62PURZ-74B3AY0	*1, *2
		WD62PURZ-85B3AY0	
4TB	Western Digital	ST6000VX001	*2, *3
	Seagate	WD43PURZ-74BWPY0	
4TB	Western Digital	WD43PURZ-85BWPY0	
		Seagate	ST4000VX016
3TB	Western Digital	WD33PURZ-74BWPY0	*1
		WD33PURZ-85BWPY0	
		WD30PURZ-74AKKY0	*1
2TB	Western Digital	WD30PURZ-85AKKY0	
		WD22PURZ-74B4ZY0	*1
		WD22PURZ-85B4ZY0	

Discontinued HDDs

Capacity	Vendor	Model	Note
6TB	Western Digital	WD60EFRX-68MYMN1	*2
		WD60EFRX-68L0BN1	*2
		WD60PURX-64T0ZY0	*2
		WD60PURX-64T0ZY1	*2
		WD60PURZ-85ZUFY1	*2
		WD63PURZ-74B4VY0	Discontinued in Q1 CY2023
		WD63PURZ-85B4VY0	*1
		WD50EFRX-68MYMN1	*2
		WD50EFRX-68L0BN1	*2
		WD50PURX-64T0ZY0	*2
5TB	Western Digital	WD40PURX-64GVNY0	
		WD40PURX-64NZ6Y0	
		WD40PURZ-85TTDY0	
		WD40EFRX-68WT0N0	
4TB	Western Digital	WD40PURZ-74AKKY0	*1
		WD40PURZ-85AKKY0	
		WD42PURZ-74B4YY0	Discontinued in Q1 CY2023
		WD42PURZ-85B4YY0	*1

Capacity	Vendor	Model	Note
3TB	Western Digital	WD30PURX-64P6ZY0	
		WD30PURZ-85GU6Y0	
		WD30EFRX-68EUZNO	
2TB	Western Digital	WD20PURX-64P6ZY0	
		WD20PURZ-85GU6Y0	
		WD20EFRX-68EUZNO	
		WD20PURZ-74AKKY0	*1
		WD20PURZ-85AKKY0	

*1 The difference between "-74" and "-85" depends on the WD sales route.

*2 Please refer to page 2, not to fix two screws into bottom side of HDD.

*3 To use Seagate SkyHawk series, it is necessary to set the HDD SSC setting to "OFF" in advance. And need to choose the screws to install the HDDs. Please refer to page 3 for instructions.

HDD Compatibility Chart (Discontinued Model)

WJ-NX200K

3rd March 2023



Latest Firmware Version : V5.20

3.5" SATA – Advanced Format

Current HDDs

Capacity	Vendor	Model	Note
8TB	Western Digital	WD84PURZ-74B2YY0	*1, *2
		WD84PURZ-85B2YY0	
6TB	Western Digital	WD64PURZ-74BWUY0	*1
		WD64PURZ-85BWUY0	
		WD62PURZ-74B3AY0	*1, *2
		WD62PURZ-85B3AY0	
	Seagate	ST6000VX001	*2, *3
4TB	Western Digital	WD43PURZ-74BWPY0	
		WD43PURZ-85BWPY0	
3TB	Western Digital	WD33PURZ-74BWPY0	*1
		WD33PURZ-85BWPY0	
3TB	Western Digital	WD30PURZ-74AKKY0	*1
		WD30PURZ-85AKKY0	
		WD22PURZ-74B4ZY0	*1
2TB	Western Digital	WD22PURZ-74B4ZY0	*1
		WD22PURZ-85B4ZY0	

Discontinued HDDs

Capacity	Vendor	Model	Note
6TB	Western Digital	WD60EFRX-68MYMN1	*2
		WD60EFRX-68L0BN1	*2
		WD60PURX-64T0ZY0	*2
		WD60PURX-64T0ZY1	*2
		WD60PURZ-85ZUFY1	*2
		WD63PURZ-74B4VY0	Discontinued in Q1 CY2023
		WD63PURZ-85B4VY0	*1
		WD50EFRX-68MYMN1	*2
		WD50EFRX-68L0BN1	*2
		WD50PURX-64T0ZY0	*2
5TB	Western Digital	WD40PURX-64GVNY0	
		WD40PURX-64NZ6Y0	
		WD40PURZ-85TTDY0	
		WD40EFRX-68WT0N0	
		WD40PURZ-74AKKY0	*1
		WD40PURZ-85AKKY0	*1
		WD42PURZ-74B4YY0	*1
		WD42PURZ-85B4YY0	*1
		WD42PURZ-85B4YY0	Discontinued in Q1 CY2023
		WD42PURZ-85B4YY0	*1
4TB	Western Digital	WD40PURX-64GVNY0	
		WD40PURX-64NZ6Y0	
		WD40PURZ-85TTDY0	
		WD40EFRX-68WT0N0	
		WD40PURZ-74AKKY0	*1
		WD40PURZ-85AKKY0	*1
		WD42PURZ-74B4YY0	*1
		WD42PURZ-85B4YY0	*1
		WD42PURZ-85B4YY0	Discontinued in Q1 CY2023
		WD42PURZ-85B4YY0	*1

Capacity	Vendor	Model	Note
3TB	Western Digital	WD30PURX-64P6ZY0	
		WD30PURZ-85GU6Y0	
		WD30EFRX-68EUZNO	
2TB	Western Digital	WD20PURX-64P6ZY0	
		WD20PURZ-85GU6Y0	
		WD20EFRX-68EUZNO	
		WD20PURZ-74AKKY0	*1
		WD20PURZ-85AKKY0	

*1 The difference between "-74" and "-85" depends on the WD sales route.

*2 Please refer to page 2, not to fix two screws into bottom side of HDD.

*3 To use Seagate SkyHawk series, it is necessary to set the HDD SSC setting to "OFF" in advance. And need to choose the screws to install the HDDs. Please refer to page 3 for instructions.

HDD Compatibility Chart (Discontinued Model)

WJ-NV300K



3rd March 2023

Latest Firmware Version : V2.30

3.5" SATA

Current HDDs

Capacity	Vendor	Model	Note
6TB	Western Digital	WD62PURZ-74B3AY0	*1
		WD62PURZ-85B3AY0	
		WD64PURZ-74BWUY0	*1
		WD64PURZ-85BWUY0	
	Seagate	ST600VX001	*3
4TB	Western Digital	WD43PURZ-74BWPY0	*1
		WD43PURZ-85BWPY0	
3TB		WD33PURZ-74BWPY0	*1
		WD33PURZ-85BWPY0	
		WD30PURZ-74AKKY0	*1
		WD30PURZ-85AKKY0	
2TB	WD22PURZ-74B4ZY0	*1	
	WD22PURZ-85B4ZY0		

Discontinued HDDs

Capacity	Vendor	Model	Note
6TB	Western Digital	WD60EFRX-68MYMN1	
		WD60EFRX-68L0BN1	
		WD60PURX-64TOZY0	
		WD60PURX-64TOZY1	
		WD60PURZ-85ZUFY1	
		WD63PURZ-74B4VY0	Discontinued in Q1 2023
		WD63PURZ-85B4VY0	*1
5TB	Western Digital	WD50EFRX-68MYMN1	
		WD50EFRX-68L0BN1	
		WD50PURX-64TOZY0	
		WD50PURZ-85ZUFY1	
4TB	Western Digital	WD40EURX-63BMCY0	
		WD40PURX-64GVNY0	
		WD40PURX-64NZ6Y0	
		WD40PURZ-85TTDY0	
		WD40PURZ-74AKKY0	*1
		WD40PURZ-85AKKY0	
		WD42PURZ-74B4YY0	Discontinued in Q1 2023
		WD42PURZ-85B4YY0	*1
		WD40EFRX-68WT0N0	

Capacity	Vendor	Model	Note
3TB	Western Digital	WD30EURX-63T0FY0	
		WD30PURX-64P6ZY0	
		WD30PURZ-85GU6Y0	
		WD30EFRX-68EUZNO	
2TB	Western Digital	WD20EURX-63T0FY0	
		WD20PURX-64P6ZY0	
		WD20PURZ-85GU6Y0	
		WD20PURZ-74AKKY0	*1
		WD20PURZ-85AKKY0	
		WD20EFRX-68EUZNO	
1TB	Western Digital	WD10EURX-63FH1Y0	

*1 The difference between "-74" and "-85" depends on the WD sales route.

*2 Please refer to page 2, not to fix two screws into bottom side of HDD.

*3 To use Seagate SkyHawk series, it is necessary to set the HDD SSC setting to "OFF" in advance. And need to choose the screws to install the HDDs. Please refer to page 3 for instructions.

HDD Compatibility Chart (Discontinued Model)

WJ-HDE400 with WJ-NV300K

3rd March 2023



Latest Firmware Version : V1.31

3.5" SATA

Current HDDs

Capacity	Vendor	Model	Note
6TB	Western Digital	WD62PURZ-74B3AY0	*1, *2
		WD62PURZ-85B3AY0	
	Seagate	WD64PURZ-74BWUY0	*1, *2
		WD64PURZ-85BWUY0	
4TB	Western Digital	ST6000VX001	*2, *3
		WD43PURZ-74BWPY0	*1
3TB	Western Digital	WD43PURZ-85BWPY0	
		WD33PURZ-74BWPY0	*1
2TB	Western Digital	WD33PURZ-85BWPY0	
		WD30PURZ-74AKKY0	*1
		WD30PURZ-85AKKY0	
		WD22PURZ-74B4ZY0	
		WD22PURZ-85B4ZY0	

Discontinued HDDs

Capacity	Vendor	Model	Note
6TB	Western Digital	WD60EFRX-68MYMN1	*2
		WD60EFRX-68L0BN1	*2
		WD60PURX-64T0ZY0	*2
		WD60PURX-64T0ZY1	*2
		WD60PURZ-85ZUFY1	*2
		WD63PURZ-74B4VY0	Discontinued in Q1 2023
5TB	Western Digital	WD63PURZ-85B4VY0	*1, *2
		WD50EFRX-68MYMN1	*2
		WD50EFRX-68L0BN1	*2
4TB	Western Digital	WD50PURX-64T0ZY0	*2
		WD40PURX-64GVNY0	
		WD40PURX-64NZ6Y0	
		WD40PURX-85TTDY0	
		WD40EFRX-68WT0N0	
		WD40PURZ-74AKKY0	*1
		WD40PURZ-85AKKY0	
		WD42PURZ-74B4YY0	Discontinued in Q1 2023
WD42PURZ-85B4YY0	*1		

Capacity	Vendor	Model	Note
3TB	Western Digital	WD30PURX-64P6ZY0	
		WD30PURZ-85GU6Y0	
		WD30EFRX-68EUZNO	
2TB	Western Digital	WD20PURX-64P6ZY0	
		WD20PURZ-85GU6Y0	
		WD20PURZ-74AKKY0	*1
		WD20PURZ-85AKKY0	
		WD20EFRX-68EUZNO	

*1 The difference between "-74" and "-85" depends on the WD sales route.

*2 Please refer to page 2, not to fix two screws into bottom side of HDD.

*3 To use Seagate SkyHawk series, it is necessary to set the HDD SSC setting to "OFF" in advance. And need to choose the screws to install the HDDs. Please refer to page 3 for instructions.

HDD Compatibility Chart (Discontinued Model)

WJ-NV200K



3rd March 2023

3.5" SATA

Latest Firmware Version : V2.62

Current HDDs

Discontinued HDDs

Capacity	Vendor	Model	Note
6TB	Western Digital	WD62PURZ-74B3AY0	*1
		WD62PURZ-85B3AY0	
	Seagate	WD64PURZ-74BWUY0	*1
		WD64PURZ-85BWUY0	
4TB	Western Digital	ST6000VX001	*3
		WD43PURZ-74BWPY0	*1
3TB	Western Digital	WD43PURZ-85BWPY0	
		WD33PURZ-74BWPY0	*1
		WD33PURZ-85BWPY0	
		WD30PURZ-74AKKY0	*1
2TB	Western Digital	WD30PURZ-85AKKY0	
		WD22PURZ-74B4ZY0	*1
		WD22PURZ-85B4ZY0	

Capacity	Vendor	Model	Note
6TB	Western Digital	WD60EFRX-68MYMN1	
		WD60EFRX-68L0BN1	
		WD60PURX-64T0ZY0	
		WD60PURX-64T0ZY1	
		WD60PURZ-85ZUFY1	
		WD63PURZ-74B4VY0	Discontinued in Q1 2023
5TB	Western Digital	WD63PURZ-85B4VY0	*1
		WD50EFRX-68MYMN1	
		WD50EFRX-68L0BN1	
		WD50PURX-64T0ZY0	
4TB	Western Digital	WD40EURX-63BMCY0	
		WD40PURX-64GVNY0	
		WD40PURX-64NZ6Y0	
		WD40PURZ-85TTDY0	
		WD40PURZ-74AKKY0	*1
		WD40PURZ-85AKKY0	
		WD42PURZ-74B4YY0	Discontinued in Q1 2023
		WD42PURZ-85B4YY0	*1
WD40EFRX-68WT0N0			

Capacity	Vendor	Model	Note
3TB	Western Digital	WD30EURX-63T0FY0	
		WD30PURX-64P6ZY0	
		WD30PURZ-85GU6Y0	
		WD30EFRX-68EUZNO	
2TB	Western Digital	WD20EURX-63T0FY0	
		WD20PURX-64P6ZY0	
		WD20PURZ-85GU6Y0	
		WD20PURZ-74AKKY0	*1
1TB	Western Digital	WD20PURZ-85AKKY0	
		WD20EFRX-68EUZNO	
		WD10EURX-63FH1Y0	

*1 The difference between "-74" and "-85" depends on the WD sales route.

*2 Please refer to page 2, not to fix two screws into bottom side of HDD.

HDD Compatibility Chart (Discontinued Model)

WJ-ND400K
WJ-HD616K
WJ-HD716K
WJ-HDE400

Very Important Notification for Compatibility of Panasonic NVR/DVR's with AF (Advanced Format) HDD's

ND400	HD616/716	HDE400	Note
V3.20 or above	V2.30 or above	V1.20 or above	These versions are compatible with AF HDD's. (AF HDD has 4K-byte data in one sector, while legacy HDD has 512byte in one sector.)
V3.10 or below	V2.20 or below	V1.07 or below	These versions are not compatible with AF HDD's. If AF HDD will be installed into DVR's/NVR of these older versions, lack of recorded image/video, frequent restart of recorder, or some unexpected troubles may happen.

HDD Compatibility Chart (Discontinued Model)

3rd March 2023

WJ-ND400
WJ-HDE400



Latest Firmware Version : V6.10 (ND400)

3.5" SATA – Advanced Format

ND400 MUST be V3.20 or above. (Please refer to page 23)

V1.31 (HDE400)

Current HDDs

Discontinued HDDs

Capacity	Vendor	Model	Note
6TB	Western Digital	WD62PURZ-74B3AY0	*1, *2
		WD62PURZ-85B3AY0	
	Seagate	WD64PURZ-74BWUY0	*1, *2
		WD64PURZ-85BWUY0	
4TB	Western Digital	ST600VX001	*3
		WD43PURZ-74BWPY0	*1
3TB	Western Digital	WD43PURZ-85BWPY0	
		WD33PURZ-74BWPY0	*1
		WD33PURZ-85BWPY0	
		WD30PURZ-74AKKY0	*1
2TB	Western Digital	WD30PURZ-85AKKY0	
		WD22PURZ-74B4ZY0	
		WD22PURZ-85B4ZY0	

Capacity	Vendor	Model	Note
6TB	Western Digital	WD60EFRX-68MYMN1	*2
		WD60EFRX-68L0BN1	*2
		WD60PURX-64T0ZY0	*2
		WD60PURX-64T0ZY1	*2
		WD60PURZ-85ZUFY1	*2
		WD63PURZ-74B4VY0	Discontinued in Q1 2023
5TB	Western Digital	WD63PURZ-85B4VY0	*1, *2
		WD50EFRX-68MYMN1	*2
		WD50EFRX-68L0BN1	*2
4TB	Western Digital	WD50PURX-64T0ZY0	*2
		WD40PURX-64GVNY0	
		WD40PURX-64NZ6Y0	
		WD40PURZ-85TTDY0	
		WD40PURZ-74AKKY0	*1
		WD40PURZ-85AKKY0	
		WD42PURZ-74B4YY0	Discontinued in Q1 2023
		WD42PURZ-85B4YY0	*1
		WD40EFRX-68WT0N0	

Capacity	Vendor	Model	Note
3TB	Western Digital	WD30PURX-64P6ZY0	
		WD30PURZ-85GU6Y0	
		WD30EFRX-68EUZNO	
2TB	Western Digital	WD20PURX-64P6ZY0	
		WD20PURZ-85GU6Y0	
		WD20PURZ-74AKKY0	*1
		WD20PURZ-85AKKY0	
		WD20EFRX-68EUZNO	

*1 The difference between "-74" and "-85" depends on the WD sales route.

HDD Compatibility Chart (Discontinued Model)

3rd March 2023

WJ-HD616K
WJ-HD716K
WJ-HDE400



Current Firmware Version : V2.63 (HD616/716)
V1.20 (HDE400)

3.5" SATA – Advanced Format

HD616/HD716 MUST be V2.30 or above. (Please refer to page 23)

Current HDDs

Discontinued HDDs

Capacity	Vendor	Model	Note
6TB	Western Digital	WD62PURZ-74B3AY0	*1, *2
		WD62PURZ-85B3AY0	
		WD64PURZ-74BWUY0	*1, *2
		WD64PURZ-85BWUY0	
	Seagate	ST6000VX001	*2, *3
4TB	Western Digital	WD43PURZ-74BWPY0	*1
		WD43PURZ-85BWPY0	
3TB		WD33PURZ-74BWPY0	*1
		WD33PURZ-85BWPY0	
	WD30PURZ-74AKKY0	*1	
	WD30PURZ-85AKKY0		
2TB		WD22PURZ-74B4ZY0	
		WD22PURZ-85B4ZY0	

Capacity	Vendor	Model	Note
6TB	Western Digital	WD60EFRX-68MYMN1	*2
		WD60EFRX-68L0BN1	*2
		WD60PURX-64T0ZY0	*2
		WD60PURX-64T0ZY1	*2
		WD60PURZ-85ZUFY1	*2
		WD63PURZ-74B4VY0	Discontinued in Q1 2023
		WD63PURZ-85B4VY0	*1, *2
5TB		WD50EFRX-68MYMN1	*2
		WD50EFRX-68L0BN1	*2
		WD50PURX-64T0ZY0	*2
4TB		WD40PURX-64GVNY0	
		WD40PURX-64NZ6Y0	
		WD40PURZ-85TTDY0	
		WD40PURZ-74AKKY0	*1
		WD40PURZ-85AKKY0	
		WD42PURZ-74B4YY0	Discontinued in Q1 2023
		WD42PURZ-85B4YY0	*1
		WD40EFRX-68WT0N0	

Capacity	Vendor	Model	Note
3TB	Western Digital	WD30PURX-64P6ZY0	
		WD30PURZ-85GU6Y0	
		WD30EFRX-68EUZNO	
2TB		WD20PURX-64P6ZY0	
		WD20PURZ-85GU6Y0	
		WD20PURZ-74AKKY0	*1
		WD20PURZ-85AKKY0	
		WD20EFRX-68EUZNO	

*1 The difference between "-74" and "-85" depends on the WD sales route.

*2 Please refer to page 2, not to fix two screws into bottom side of HDD.

*3 To use Seagate SkyHawk series, it is necessary to set the HDD SSC setting to "OFF" in advance. And need to choose the screws to install the HDDs. Please refer to page 3 for instructions.

HDD Compatibility Chart (Discontinued Model)

31st October 2022

WJ-HL204/208
(for PAL only)



3.5" SATA

Latest Firmware Version : V1.0.1

Discontinued HDDs

Capacity	Vendor	Model	Note
2TB	Seagate	ST2000VM002	Firmware:SC01
1TB		ST31000322CS	Firmware:SC13
500GB		ST3500312CS	Firmware:SC13
250GB		ST3250312CS	Firmware:SC13

1. Download SeaChest Utilities from the following URL then install it to Windows PC.

<https://www.seagate.com/support/software/seachest/>

2. Connect target HDD via USB to the PC which SeaChest Utilities is installed.

3. Double click SeaChest Utilities icon on desktop and launch SeaChest Utilities.

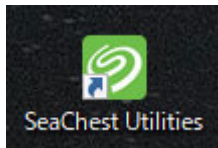

4. Enter the following command from Windows Command Prompt.

Seachest_Basics_x64_windows.exe --scan

```
C:\Program Files\Seagate\SeaChest>SeaChest_Basics_x64_windows.exe --scan
-----
SeaChest_Basics - Seagate drive utilities - NVMe Enabled
Copyright (c) 2014-2022 Seagate Technology LLC and/or its Affiliates, All Rights Reserved
SeaChest_Basics Version: 3.3.1-3_2_1 X86_64
Build Date: Jul 26 2022
Today: Wed Nov  2 09:43:49 2022
-----
Vendor  Handle      Model Number      Serial Number      FwRev
-----
NVMe    PD0          KRG4A7NV256G TOSHIBA MEMORY 61UPG2HTQS12      AFP41101
ST4000VX PD1          016-3CV104       152D20337A0C
-----
```

PC drive

Target drive

Seagate Model# won't be displayed because HDD is connected via USB bridge chip.
Check ID# (PD1 for above case) of target drive.

5. Confirm the current SSC condition by entering the following command.

Seachest_Configure_x64_windows.exe -d PD1 --ssc info

```
C:\Program Files\Seagate\SeaChest>SeaChest_Configure_x64_windows.exe -d PD1 --ssc info
=====
SeaChest_Configure - Seagate drive utilities - NVMe Enabled
Copyright (c) 2014-2022 Seagate Technology LLC and/or its Affiliates, All Rights Reserved
SeaChest_Configure Version: 2.1.0-3_2_1 X86_64
Build Date: Jul 26 2022
Today: Wed Nov  2 09:47:41 2022
=====
¥¥.¥PhysicalDrive1 - 016-3CV104 - - - ATA
SSC Feature is set to the drive's default value
```

default value : SSC Feature is enabled
(SSC is "ON")

6. Turn off SSC by entering the following command.

```
Seachest_Configure_x64_windows.exe -d PD1 --ssc disable
```

```
C:\Program Files\Seagate\SeaChest>SeaChest_Configure_x64_windows.exe -d PD1 --ssc disable
-----
SeaChest_Configure - Seagate drive utilities - NVMe Enabled
Copyright (c) 2014-2022 Seagate Technology LLC and/or its Affiliates, All Rights Reserved
SeaChest_Configure Version: 2.1.0-3_2_1 X86_64
Build Date: Jul 26 2022
Today: Wed Nov  2 09:50:50 2022
-----
¥¥.¥PhysicalDrive1 - 016-3CV104 - - - ATA
Successfully set SSC feature to disabled
Please power cycle the drive to make the change take effect.
```

Power cycle the drive to make the change take effect.
(No need to close SeaChest Utilities during power cycle)

7. Confirm SSC setting had been changed by entering the following command.

Seachest_Configure_x64_windows.exe -d PD1 --ssc info

```
C:\Program Files\Seagate\SeaChest>Seachest_Configure_x64_windows.exe -d PD1 --ssc info
=====
SeaChest_Configure - Seagate drive utilities - NVMe Enabled
Copyright (c) 2014-2022 Seagate Technology LLC and/or its Affiliates, All Rights Reserved
SeaChest_Configure Version: 2.1.0-3_2_1 X86_64
Build Date: Jul 26 2022
Today: Wed Nov  2 09:53:28 2022
=====
¥¥.¥PhysicalDrive1 - 016-3CV104 - 152D20337A0C - - ATA
SSC Feature is disabled
```

SSC is "OFF"

8. Power off USB-SATA converter and then remove the HDD from the converter.

Recorder Maintenance Guide

Introduction

As network disk recorders used for security system generally operate all-year-round, they need regular maintenance to avoid system failures and to keep their performance.

What is a hard disk drive?

What is a hard disk drive?

- A hard disk drive (an HDD) is a device which reads and writes digital data magnetically with the disks (platters) that spin and the head floating above the disks.

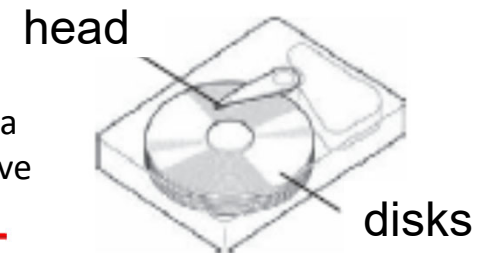

Points to Note

Point # 1 Avoid Vibration

The magnetic head floating above the disks in an HDD is set extremely close to the disks with the spacing that even cigarette smoke or flu virus cannot go through. Therefore, vibration can cause head crash and generate tiny dust if the head gets out of correct position. This results in creating fatal scratches in an HDD. Please install your recorder in a stable place away from declination, vibration or physical impact. Also, as an impact of sound (sound pressure) **such as the radiation sound from gas distinguishing agent system** can affect the speed of data transfer on HDDs, please install your recorder in the place without loud noise.

HDD = Precision Device

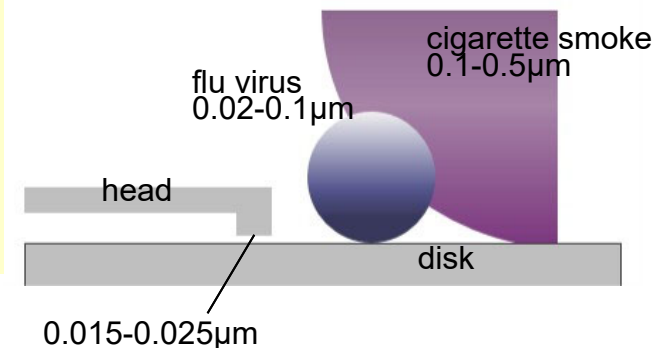

Recorder Maintenance Guide

Point # 2 Keep Your Recorder from Getting Hot

Keeping HDDs exposed to high temperature results in the deterioration of its head and disks, and it can shorten the HDD life as well. Please consider ventilation when installing. The ambient operating temperature is 5 degrees Celsius to 45 degrees Celsius (the recommended temperature is 25 degrees Celsius).

Consider Ventilation When Installing

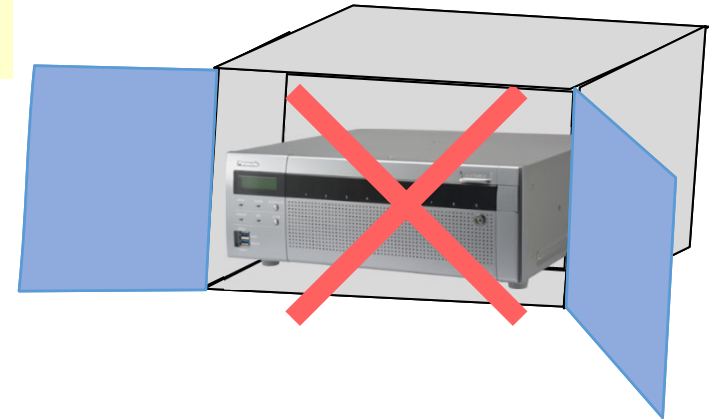

Point # 3 Avoid Static Electricity and Condensation

Static electricity can be the cause of electronic parts failure in an HDD.

Condensation can cause a malfunction of a recorder as the head sticks to the disk due to the water.

Condensation occurs;

- when relocating the recorder to a place with sudden change in temperature and humidity.
- in the room just after heated.
- when the recorder is relocated from the cooled place to the heated place with high humidity.

Prevent Static Electricity and Condensation

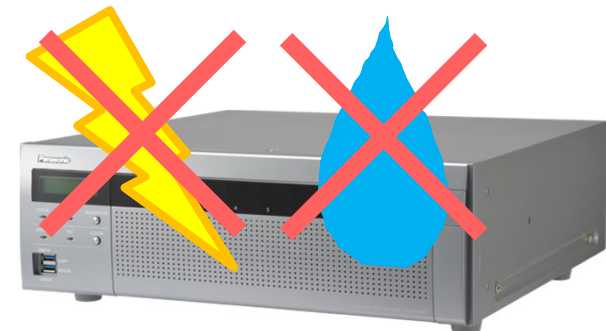

Recorder Maintenance Guide

Regular Maintenance is Necessary for a Network Disk Recorder

As a network disk recorder has HDDs for data storage, regular maintenance is necessary to use the recorder under its optimal conditions.

The Major Causes of Network Disk Recorder Failure

The Major causes of network disk recorder failure results from HDD malfunctions as below.

- The head crashes on the disk due to vibration or impact on the recorder and that creates scratches on the disk.
- Operating your recorder in high temperature environment causes the incorrect spacing between the head and the disks and that causes a head crush and creates scratches on the disk.
- Non-proper spin of the motor and the deterioration of the head's characteristics occur due to the long term use of HDDs. These can cause the write/ read error. The scratches on the disk gets larger in several months and causes a recorder failure.

Cutaway of an HDD

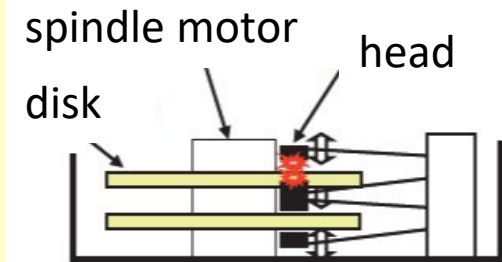

Tips for the Stable Operation of Your Network Disk Recorder

As the parts in a disk recorder are consumable, it is necessary to maintain your recorder regularly. The consumable parts in a network disk recorder are the followings.

HDD Unit / cooling fan / built-in backup battery / damper rubber for fixing HDDs. (Please note that the applied parts varies depending on the models.)

Maintenance including parts exchange leads to the stable operation of your recorder.

Recorder Maintenance Guide

Estimated Replacement Period of an HDD

Although the HDD life differs depending on the usage environment, an HDD is certainly a consumable device. When used at an ambient temperature of 25 degrees Celsius, errors such as write error may start to occur at the operating time of 20,000 hours. When it reaches over 30,000 hours, the HDD can die due to the deterioration of the read/ write head or the motor in it. Keep the ambient temperature under 25 degrees Celsius and replace HDDs at the point of 18,000 hours for your secure data management. Please note that this is our estimated replacement period for reference and does not guarantee the life of your HDDs.

Hour Meter:

Approx. 9,000h = 1 year, : Approx. 18,000h = 2 years, Approx. 26,000h = 3 years, Approx. 35,000h = 3 years, Approx. 44,000h = 5 years

HDD Life Characteristics

- Excerpted from Our HDD Reliability Data

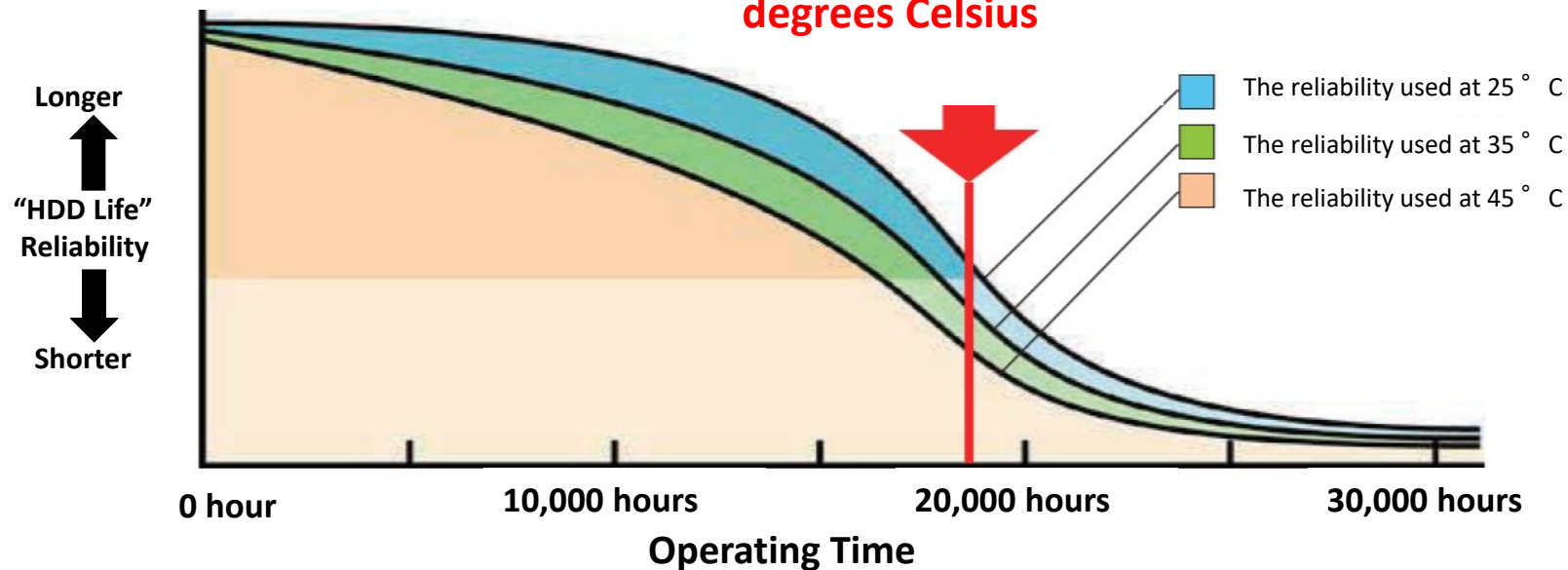

Recorder Maintenance Guide

HDD hour meter warning

HDD hour meter warning is a function that performs a warning when the operating time of an HDD reaches a specified level. With default setting, it performs a warning at the operating time of 20,000 hours where errors such as write error can start to occur. As described on the previous slide, the reliability of an HDD starts to decrease rapidly before the operating time reaches 20,000 hours. Therefore we recommend to replace HDDs at the point of 18,000 hours to prevent possible failures and manage data securely.

The screenshot displays the 'Maintenance > System management' interface. It features three tabs: 'System information', 'HDD information', and 'System management'. The 'System management' tab is active, showing a 'System setup' section with various configuration options. The 'HDD hour meter warning' option is highlighted with a red box and is set to '20000 h'. Below this, there are sections for 'Logs' (Access log, Operation log, Network log) and 'Functions for maintenance' (Registration of license, Reset all settings, Save data, Load data, Firmware update, Other).

System setup	Value
Error output duration	2 s
Error buzzer duration	2 s
Safe shutdown time	10 s
HDD stand-by control mode	Off
HDD hour meter warning	20000 h
Auto data delete	Off
Camera time auto synchronization	On

Logs	Action
Access log	View >
Operation log	View >
Network log	View >

Functions for maintenance	Action
Registration of license (This product, camera extension, etc.)	Setup >
Registration of license (Security)	Setup >
Registration of license (Optional extension)	Setup >
Reset all settings	Execute >
Save data (to USB medium)	Execute >
Load data (from USB medium)	Execute >
Firmware update	Execute >
Other	Setup >

Recorder Maintenance Guide

To Prevent HDD troubles

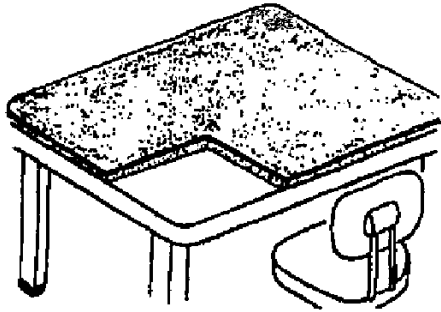

Use Antistatic & shock prevention mat

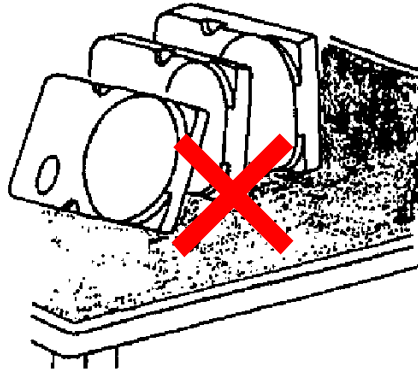

Do not place vertically

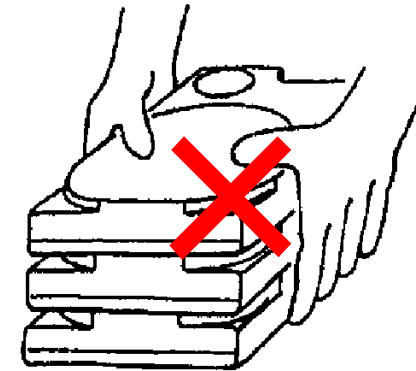

Do not stack

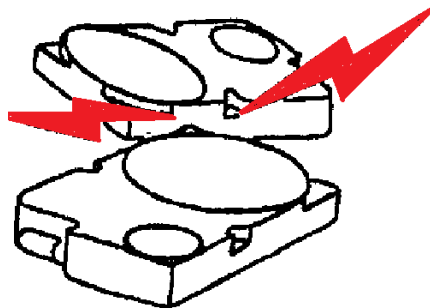

Do not hit

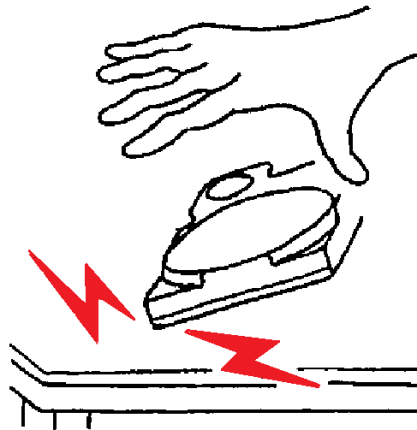

Do not drop



Do not use a regular electric screwdriver