

iii·PRO

Operating Instructions Network Disk Recorder

Model No. **WJ-NU101K Series**
WJ-NU201K Series
WJ-NU300K Series
WJ-NU301K Series

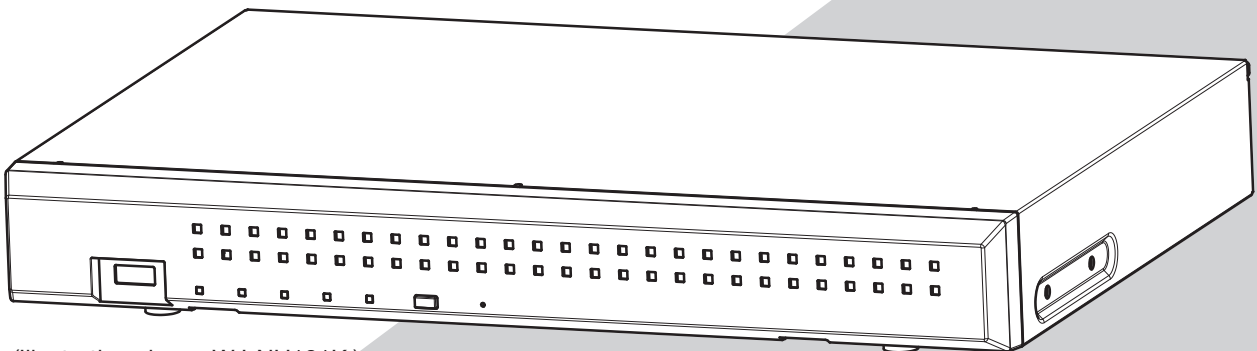

(Illustration shows WJ-NU101K.)

WJ-NU101K Series refer to WJ-NU101K, WJ-NU101KG and WJ-NU101KGV.
WJ-NU201K Series refer to WJ-NU201K, WJ-NU201KG and WJ-NU201KGV.
WJ-NU300K Series refer to WJ-NU300K, WJ-NU300KG and WJ-NU300KGV.
WJ-NU301K Series refer to WJ-NU301K, WJ-NU301KG and WJ-NU301KGV.

HDMI[®]
HIGH-DEFINITION MULTIMEDIA INTERFACE

Before attempting to connect or operate this product,
please read these instructions carefully and save this manual for future use.

The model number is abbreviated in some descriptions in this manual.

CONTENTS

Preface	4	Confirm the hard disk drive information	
About the user manuals	4	[HDD information]	70
Abbreviations	4	Configure the settings and operations relating to	
About the settings and operation of		the system [System management]	72
the recorder	4	Manage the hard disk drives [HDD management] ...	76
Restrictions when using this product	5	How to display the "HDD management" page	76
Before using this product	7	Check the hard disk drive information [General] ..	77
Motion detection (VMD) function	7	Format the hard disk drives [Format HDD]	77
Time display of recorded images	7	About the removal process and the link	
Response to the mouse operations	7	process of hard disk drives	78
Black screen displayed when playing recorded		About the change of the	
images	8	HDD operational mode	79
Recording operation	8	Configure the security settings [Security]	80
Event type	8	Lists of the setting items (Setup menu)	81
Setup via recorder's main monitor	9	About the error logs and the network logs	97
Configure the basic settings [Basic setup]	10	Error logs	97
Display the basic setup pages	10	About the network log	99
Set up date & time and language		Operation window	100
[Date/Language]	11	Main monitor (A monitor to display the live image,	
Camera setup [Camera]	13	the playback image and the setup menu)	100
Set up recording/events [REC & event]	40	Sub monitor (monitor for display of	
Configure the settings relating to monitors		live images only)	104
[Monitor]	52	Basic operations	105
Set up the main monitor [Main monitor]	52	Logout	105
Configure the settings relating to sub monitors		Login operation at startup	106
[Sub monitor]	54	Monitor live images	107
Configure other settings relating to monitors		About the operation panel	107
[Advanced setup]	55	Switch between control screen and wide view	
Configure the settings relating to network		screen	113
[Network]	56	1-screen display	114
Configure the basic network settings [Basic]	56	Display images from cameras on	
Configure the settings relating to the mail		a multiscreen	115
notification [e-Mail]	58	Use digital zoom	116
Configure the TCP alarm notification settings		Correct the fisheye image	117
[TCP alarm notification]	59	Operate the camera	118
Configure HTTP alarm notification settings		Camera control panel	118
[HTTP alarm]	60	Event function	123
Configure the settings relating to NTP/SNMP		Action to be taken upon an event occurrence ...	123
synchronization [NTP/SNMP]	61	Stop buzzer beeping	124
Configure the settings relating to the user		Cancel the alarm action	125
management [User management]	63	Cancel the error action	125
Configure the basic settings relating to user		Record images	126
management [Basic]	63	Record images (Schedule recording)	126
Register, edit or delete the user information		Emergency recording	127
[User registration]	65	Play recorded images	128
Edit the administrator information		Playback operation panel	130
[Administrator setup]	67	Play images from a designated point	133
Register, edit or delete host [Host registration] ..	68	Play image recorded at a designated	
Configure the settings relating to maintenance		date & time	133
[Maintenance]	69	Play the latest recorded image	134
Check the system information such as the version		Playback by designating a timeline	135
[System information]	69	Search and play	137

Play images selected from logs (Log search).....	137	Download root certificate	184
Display thumbnail screen and paly back (Thumbnail search)	138	Update the firmware.....	184
Search and play recorded images triggered by motion detection (VMD search).....	139	Notification by e-mail	185
Copy recorded images	142	Alarm mail.....	185
Format USB medium.....	145	Warning mail.....	185
Play back copied images with this recorder	146	Troubleshooting.....	187
List of operation items.....	148	Glossary	192
Configure the network settings	151		
Configure the network settings of the recorder..	151		
Configure the network settings of the PC	151		
Network security of the recorder.....	154		
The security function of the recorder	154		
Enhance network security	154		
Display the operation window	156		
About the operation window	157		
Top Page	157		
Control panel.....	158		
Camera selection panel.....	159		
Setup panel	160		
Status display area.....	161		
Download operation area	162		
[CAM] tab	162		
[HDD] tab.....	162		
Monitor live images	163		
Display live images.....	163		
Operate the camera	164		
Event function	166		
Action to be taken upon an event occurrence...	166		
Cancel the alarm action	167		
Cancel the error action.....	167		
Play recorded images.....	168		
Play image recorded at a designated date & time .	170		
Search and play recording events (REC event search).....	171		
Copy recorded images	173		
Download recorded images currently being played.....	175		
Check a list of copied recorded images.....	176		
Play back the copied/downloaded images on a PC	178		
To play recorded images copied on the media device.....	178		
Play recorded images downloaded using a web browser	178		
How to use the viewer software.....	179		
Setup	183		
Basic operations	183		
Configure the settings	183		
Display data output logs	183		
View OSS licenses	184		

Preface

About the user manuals

- Unless otherwise noted, the screen and other descriptions in this manual are based on the WJ-NU301K as an example.
- For more information about our and Panasonic cameras in this manual and on the screen, contact your dealer.
- The maximum number of cameras for each model listed in this document is as follows.
 - NU101 Series Up to 4 cameras
 - NU201 Series Up to 8 cameras
 - NU300 Series, NU301 Series Up to 16 cameras
- The "n" in "camera n" in this manual indicates the maximum number of cameras for each model.

Abbreviations

The following abbreviations are used in this manual.

WJ-NU101K Series is called NU101.

WJ-NU210K Series is called NU201.

WJ-NU300K Series is called NU300.

WJ-NU301K Series is called NU301.

Microsoft Windows 10 is described as Windows 10.

Network cameras are described as cameras.

Personal computers are called PCs.

About the settings and operation of the recorder

- The recorder can be operated using the included mouse connected to the USB port on the rear side of the recorder and the on-screen keyboard. Refer to "Basic operations" of Installation Guide for the operation of the mouse and the on-screen keyboard.
- The camera settings are automatically done in accordance with recording settings of the recorder once the camera is registered in the recorder. If you directly change settings related to image and audio of the camera registered in the recorder, the settings may differ from those of the recorder or some functions may not work properly.
- It is also possible to perform settings and some operations of the recorder from the web browser. Refer to "Lists of the setting items" on page 81 for setting items via the web browser and "List of operation items" on page 148 for operational items via the web browser. Refer to page 156 and following pages for the operation.
- This documents is sub headed in each applicable page such as "Setup via recorder's main monitor", "Operation via recorder's main monitor", "Setup on browser" and "Operation via PC web browser".

Restrictions when using this product

When using this product, some functions have the following restrictions. Before using this product, keep the following in mind.

Restrictions for individual cameras are posted on our support website.

When connected to a monitor

- If a sub-monitor is connected while the main monitor is displaying images, the main monitor will go to black for a few seconds. The same applies in the reverse case.
- While using the sub-monitor or during re-encoding distribution, videos of 60 fps will be thinned out to 30 fps.

When using a 4K-compatible monitor

- In the case of high-resolution images or multi-screen split display, images at 60 fps may be displayed at 30 fps, and images at 30 fps may be displayed at 15 fps with thinning.

When displaying live images from the camera

- Black screen may be displayed for the first several seconds (*) when the following operations are performed while displaying live images.
 - When live images are displayed (by switching camera, etc.)
 - When the number of screen divisions is switched.
- When switching cameras, switching the number of split screens or using sequence display on the main monitor or sub monitor, depending on the camera, the font size in the camera image displayed on the other monitor may appear different.
- When a live image from a camera with a recording frame rate set to 30 ips (25 ips) is displayed on a monitor, some subjects may not be displayed smoothly.
- After settings are changed, it may take up to 10 seconds for the camera's live image to be displayed.

When playing recorded images

- First several seconds (*) may be skipped when the following operations are performed while playing recorded images.
 - When cameras are switched
 - When the number of screen divisions is switched (When zooming into/out of a paused recorded image, an image occurring several seconds before or after the displayed image may be zoomed in.)
 - When the playback button is clicked again while playing images
 - When the first frame is displayed by starting the frame by frame playback during pausing
- Playback may be performed in several seconds intervals (*) when the following operations are performed. Refer to the description of operations during playback on pages 130 and 169 for how to control playback.
 - Reverse playback
 - Fast playback/Fast reverse playback
 - Reverse frame playback
- When playing images by designating date & time, playback may start from a point several seconds* before/after the specified time or from the first frame of the next record.
- When the latest recorded image is played, playback may start from a point several seconds before/after a point that is 10 seconds before the latest recorded image. The playback may be paused some ten seconds after the start of the playback depending on the volume of recorded image data.
- When the frame rate is set to 25 ips ~ 60 ips, recorded images may not be played smoothly.
- If the load of this product is too great to continue playback, if recorded images cannot be displayed, or if there are no recorded images, playback will stop and return to live image display.

When recording images

- The actual time of recording trigger (event occurrence time, start time of the schedule recording, etc.) and the recording start time (time displayed on the recording event list) may not exactly be the same.
- When pre-event recording is set to be performed, the recording may not be performed as the set duration.
- If the frame rate is set to switch during the event recording or the emergency recording, it may take a few seconds to switch the rate depending on the refresh cycle interval.
- Depending on the camera, setting the recording frame rate to 60 ips may cause interruption of audio or reduction of the recording frame rate.

When using AI privacy guard recording

- To use the AI privacy guard recording, the extension software WV-XAE201W is installed on the camera and its setting needs to be completed. In addition, the "Target stream" in AI privacy guard setting on the target camera needs to be set to "Stream (2) & Stream (4)".
- AI privacy guard recording requires registration frames for 2 cameras.
- AI privacy guard recording uses stream 2 for recording, monitor live 1-screen display, and browser display. It also uses stream 4 for monitor live multi-screen display.
- AI privacy guard recording operates according to the recording and scheduling settings of the paired camera.
- Even if the alarm recording camera is either one of them, both cameras will record the alarms.
- AI privacy guard recording does not support SD backup recording.
- "Stream 2" in "Do not use stream 2 of camera with each function of this recorder" and "Display stream 2 live image when displaying on the monitor with 1-screen display." refers to "Stream 3" and "Stream 4".
- Depending on the camera, the upper limit of the frame rate differs when AI privacy guard is set. For details, please refer to the operating instructions of the camera.

When copying images

Copying of recorded images may start from a point several seconds (*) before the designated start time when copying recorded images.

When using a USB memory stick/ external storage device

After a USB memory stick is inserted, it may take time to recognize the medium. It also may take time if the capacity size of the inserted media is large.

When using the web browser

- When downloading playback images, downloading of recorded images may start from a point several seconds (*) earlier than the designated start time.
- When connecting via HTTPS, an error message such as "This connection does not protect your privacy" is displayed, but HTTPS communication is still possible.
- When pop-up dialogs such as alerts appear, updates to live and playback video will temporarily stop. The video is updated when the pop-up dialog is closed.

When backing up the SD memory card

- The product may not record images as set in the product if SD memory cards rather than those supporting the speed class 10 are used. Refer to the operating instructions of the camera for further information.
- If bandwidth control of the camera is changed to a value other than the default value, the SD backup may not function. Refer to the operating instructions of the camera for further information.

When using viewer software

- The playback speed may become slow when playing back high resolution high frame rate images.

When using i-PRO Mobile APP

- When using a sub-monitor, the maximum number of mobile playback connections is one.

* Time (seconds) differs depending on the refresh interval setting of the camera (0.2 - 5 seconds). In the recorder, the refresh interval setting of the camera is set to 1 second at the camera registration.

Refer to the operating instructions of the camera for information about the refresh interval setting.

Before using this product

Motion detection (VMD) function

The motion detection (VMD) function of cameras detects motions referring to changes of luminance (brightness) in areas set in advance.

The motion detection function will not effectively work in the following situations or may sometimes be malfunctioning.

- When there is a very little difference in luminance (brightness) between a background and a subject
- When brightness of images is low such as at night
- When a subject moves very slow
- When a subject is very small
- When the amount of rays of light incidence changes frequently such as at a window or outdoors.
- When light such as sunlight or car headlight comes from outside
- When a fluorescent lamp flickers
- When a subject has depth

When configuring the motion detection settings, check the function performance both in daytime and at night after appropriately configuring the area settings and the sensitivity settings according to the camera installation conditions and possible movement of subjects. When the detection function does not work or false detection occurs, use a sensor separately. Refer to the operating instructions of the camera for further information.

Time display of recorded images

When displaying recorded images, the displayed date & time may sometimes skips. This is not a malfunction. The displayed date & time on the monitor and the recorder may sometimes not be exactly the same. This is also not malfunction.

Response to the mouse operations

While this recorder is processing multiple operations at the same time, the response to the operations from the connected mouse may temporarily become slow. This is not a malfunction.

Black screen displayed when playing recorded images

In the following cases, a black screen may be displayed during playing recorded images. However, this is not a malfunction.

- When changing cameras or screen patterns during playback or pausing
- When skipping/reverse skipping during playback
- When fast forwarding/reverse fast forwarding during playback
- When the latest recorded image is played while displaying images on a multiscreen*
- When changing the selected camera during the multi-screen display
- When going to the next recording event list by fast forwarding/reverse fast forwarding or skipping/reverse skipping during playback
- When playback operation is affected by another operation (such as when receiving multiple alarms sequentially or while copying is being performed simultaneously)

* Some camera images go black depending on the data volume.

Recording operation

The recorder can connect cameras and record their images on the HDD.

The following recording operations are available.

Schedule recording: Recording that is automatically performed at the designated time range on the designated day(s) of the week

Event recording: Recording that is automatically performed when an event occurs (such as terminal alarm/camera site alarm/command alarm, etc.)

Emergency recording: Gives priority to recording video and audio at emergency using the external switch connected to the emergency record input terminal of the recorder.

Important:

- Recording may not be performed for around 3 seconds in the following cases. However, this is not a malfunction.
 - When the settings are changed and the setup menu is closed during recording
-

Event type

The following event recording types are displayed in list form on the web browser:

SCH: Schedule recording

EMR: Emergency recording

SD: SD backup rec.

The following are detailed event recording types.

COM: Displayed when a command alarm occurred

TRM: Displayed when a terminal alarm occurred

CAM: Displayed when a camera site alarm occurred

PRE: Pre-event recording

SW1 to SW16: Extension software alarm

*Camera site alarms sent from the extension software will be recorded as extension software alarms.

Setup via recorder's main monitor

The Setup via recorder's main monitor using the mouse include [Quick setup] - [Easy Start], [Basic setup] and [Advanced setup].

[Quick setup] - Easy Start provides the minimum settings necessary to use this product, including date setting, camera registration, and recording settings. For more information on [Quick setup] - Easy Start, refer to the leaflet of "Easy Start Guide (included)".

[Basic setup] is for basic settings other than those in [Quick setup] - Easy Start, such as date and time display settings and recording operations.

[Advanced setup] provides detailed settings such as monitor settings, user management, maintenance settings, HDD management, and extended function settings.

Important:

- Cameras can be registered in either [Quick setup] or [Basic setup].
If you wish to operate with the minimum necessary settings, refer to the leaflet of "Easy Start Guide (included)".
 - When registering cameras using [Quick setup], the number of cameras to be connected must be within the maximum number of cameras for each model.
If more than the maximum number of cameras are connected using a switching hub, etc., refer to "Detect cameras for registration [Detect cameras]" (👉 page 14).
 - Only our and Panasonic cameras that are supported by this camera can be registered with [Quick setup]. Refer to our support website for the supported cameras.
 - When using a camera other than ours or Panasonic cameras with ONVIF connection, [Quick setup] - Easy Start only cannot be used to start operation. After setting the date and time, fixed IP address, user name/password, etc. on the camera, register the camera to this camera by using [Basic setup] - [Camera] - [Camera registration] to detect the camera or change the registration information.
-

Configure the basic settings [Basic setup]

The basic settings of the recorder such as date & time and recording mode, etc. can be configured on the "Basic setup" page.

The "Basic setup" page provides access to the [Date/Language], [Camera] and [REC & event] pages.

Note:

- Refer to "Configure the minimum settings [Easy Start]" of the Installation Guide for the [Quick setup] - [Easy Start] of the setup menu.
-

Display the basic setup pages

Click the desired button on the setup menu.

Note:

- The setup menu can be displayed by clicking the [Setup] button on the operation panel of the operation screen.
-

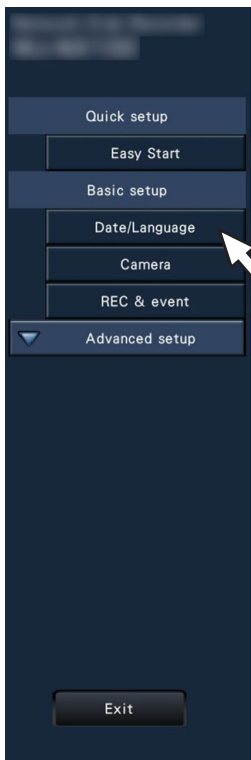

[Date/Language] button: Displays the "Date/Language" page. Perform settings such as date & time and daylight saving time.

[Camera] button: Displays the "Camera" page. Perform registration and setup of network cameras.

[REC & event] button: Displays the "REC & event" page. Configure the recording schedules and event actions.

Set up date & time and language [Date/Language]

The "Date/Language" page has the [Date & time adjustment], [Date & time settings] and [Language] tabs.

[Date & time adjustment] tab

Set the current date & time.

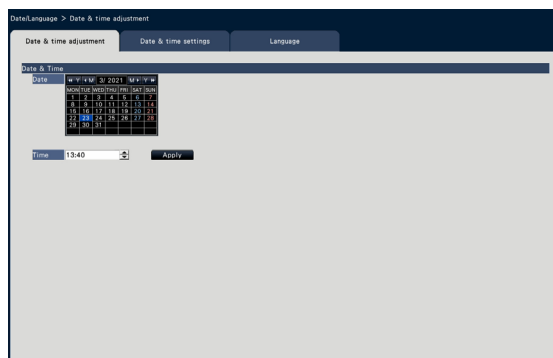

■ Date & time

[Date]

Set the current date. Select the year, month and day from the calendar.

[<<Y]/[Y>>] button: Selects the previous or next year.

[<M]/[M>] button: Selects the previous or next month.

[Time]

Set the current time.

Important:

- Click the [Apply] button after setting the date & time. →The second will be set to "00".
-

[Date & time settings] tab

Perform settings such as date & time format, time zone, daylight saving time, and time adjustment method.

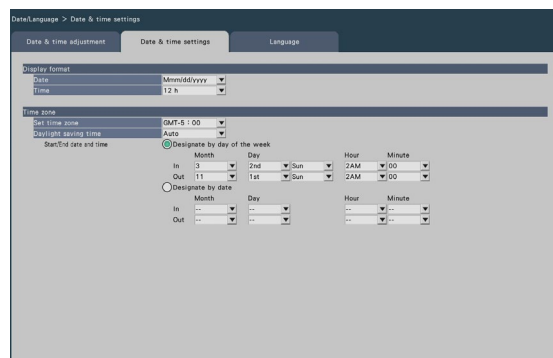

■ Display format

Select a display format for the current date & time.

Note:

- "Date & time display" on the [Camera setup] tab (Page 19) corresponds to the display format settings on this tab.
-

[Date]

Select a date/time display format. (Example: March 1, 2022)

yyyy/mm/dd: 2022/03/01
Mmm/dd/yyyy: Mar/01/2022
dd/Mmm/yyyy: 01/Mar/2022
mm/dd/yyyy: 03/01/2022
dd/mm/yyyy: 01/03/2022

Default: dd/mm/yyyy

[Time]

Select a time display format. (Example: 3 o'clock in the afternoon)

24 h: 15:00:00
12 h: 03:00:00 PM

Default: 24 h

■ Time zone

Select the time zone and shift to/from daylight saving time.

[Set time zone]

Select your time zone.

GMT-12:00 - GMT+13:00

Default: GMT

[Setup via recorder's main monitor]

Important:

- After time zone is changed, if you have specified date and time or selected from the history, the playback start time of the recorded image or the timeline display, etc. before the change will be shifted by the time difference of the changed time zone.
-

Important:

- Setting is impossible when the interval between start (In)/end (Out) is less than an hour.
-

[Daylight saving time]

Determine how to switch to/from daylight saving time. The asterisk "*" will be displayed before date & time during daylight saving time.

Out: Does not apply daylight saving time.

Auto: Automatically applies daylight saving time based on the pre-set Start/End date and time of daylight saving time.

Default: Auto

[Start/End date and time]

Set up the rule of the Start/End date and time of daylight saving time.

It is displayed when "Auto" is selected in "Daylight saving time".

Select "Designate by day of the week" or "Designate by date" as a method to assign the starting (In) and ending (Out) date and time of daylight saving time.

[Language] tab

Select the display language for the main monitor and for the web browser on the PC.

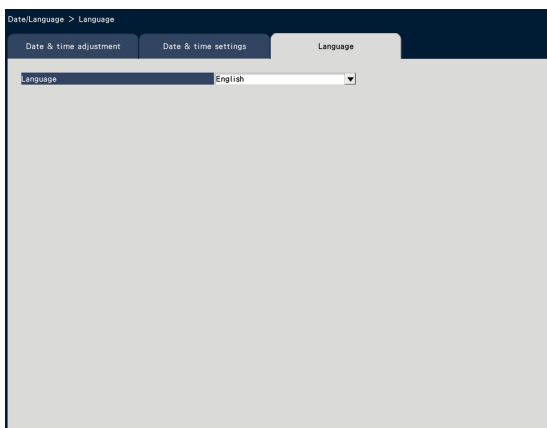
**[Language]**

Japanese/ English/ Français/ Español/ Deutsch/
Italiano/ Português/ ไทย/ 简体中文/ 繁體中文/
Tiếng Việt

Default: English

Camera setup [Camera]

The "Camera" page has the [Camera registration] tab, the [Camera setup] tab and the [Advanced setup] tab.

[Camera registration] tab

Perform settings such as the network settings of the camera (IP address and port number), and the display position on the main monitor.

When performing the initial settings, displays camera information detected/set on the "Easy Start".

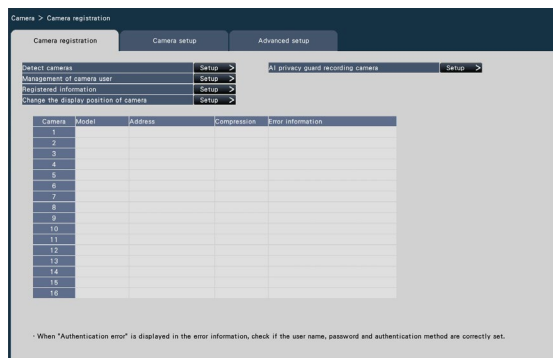

[Change the display position of camera]

The camera numbers can be interchanged. When the [Setup >] button is clicked, the "Change the display position of camera" window opens to edit the settings. (☞ Page 17)

[AI privacy guard recording camera]

The camera used for AI privacy guard recording can be selected. (☞ Page 18)

[Detect cameras]

The cameras connected to a network can be detected for registration. (☞ Page 14)

[Management of camera user]

Set a user name/password of the camera in the camera. (☞ Page 15)

[Registered information]

Change the "Model", "Option", "Address" and "Compression".

When the [Setup >] button is clicked, the "Registered information" window opens to edit the settings. (☞ Page 16)

In the event of communication trouble with the camera, one of the following error messages is displayed for "Error information".

Connection error: The communication with the camera disconnected.

Authentication error: The user authentication of the camera failed.

Camera error: The response from the camera is incorrect.

Note:

- When an error message is displayed, check the camera connections and settings (☞ operating instructions of the camera). If the problem cannot be solved, refer to "Easy Start Guide (included)" and register the camera again.
 - A camera whose part number is "RTSP" or "RTSP(FE)" does not display error information.
-

Detect cameras for registration [Detect cameras]

Clicking the [Setup >] button of "Detect cameras" on the [Camera setup] tab will display the following window. After editing the settings, click the [OK] button to save the settings and return to the [Camera registration] tab.

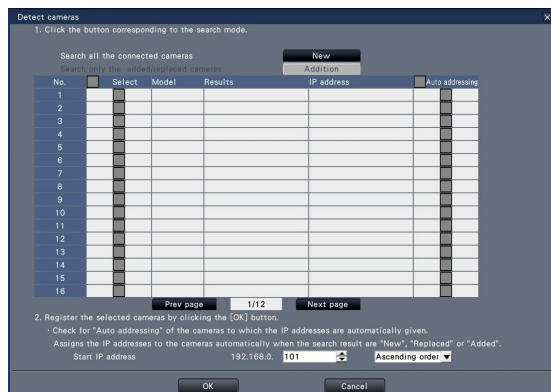

Note:

- Before the settings, register the cameras into the network. Even though it is possible to detect up to 192 cameras, only the maximum number of cameras per model can be registered.

[New] button

Deletes all the current settings and searches all the connected cameras. The models, results of the detected cameras and IP addresses will be displayed.

[Addition] button

Detects only the added or replaced cameras. The models, results of the detected cameras and IP addresses will be displayed.

[No.]

Shows a number of detected cameras. The maximum number of detectable cameras will be 192 units.

[Select]

Mark the checkboxes of cameras to register. The vacant number will be fulfilled by the subsequent camera.

[Model]

If you are using a camera manufactured by us or Panasonic that is supported by this camera, the part number of the camera will be displayed. Refer to our support website for the supported cameras.

[Results]

New: Displayed when the camera is newly connected to the recorder.

Replaced: Displayed when the camera has been replaced by another one.

Added: Displayed when the camera connection is added to the recorder.

Registered: Displayed when the camera has already been registered.

Lost: Displayed when the registered camera is not detected.

Blank: No camera is detected.

[IP address]

Displays the IP addresses configured for the detected cameras.

[Auto addressing]

The IP addresses of the cameras whose checkboxes are marked will be automatically configured.

[Start IP address]

Specify the start IP address and order when setting the IP address automatically.

Note:

- It is impossible to register cameras in other networks via the same router.
- For the security enhancement, changing of the IP address of the camera will become impossible when 20 minutes have passed after the power is turned on. Refer to the operating instructions of the camera for further information.
- When "On" is selected for the "DHCP" setting of the detected cameras, the recorder will forcibly change the setting to "Off" to give the IP addresses automatically.
- If this product does not automatically assign an IP address to the camera, set a fixed IP address to the camera that can communicate with this product.
- If the IP address of the camera is set to be assigned automatically, an IP address will be assigned to the camera when the [OK] button is clicked. In this case, the default gateway (Page 56) of the recorder is set to the default gateway of the camera.
- Click the [Cancel] button to return to the [Camera registration] tab without applying the camera detection result.

Change the password of camera [Management of camera user]

Click the [Setup >] button of "Management of camera user" on the [Camera registration] tab to display the following screen.

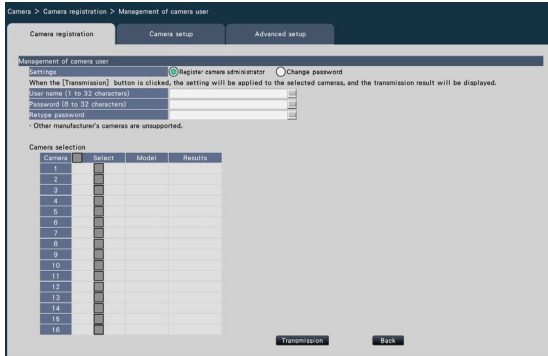

[Settings]

Select items to set up.

Register camera administrator: Registers a user name and password to a camera whose administrator is not registered. Enter a user name/password.

Note:

- Cameras that already have the User name/ Password registered cannot register another User name/Password.

Change password: Changes the password of the camera user registered to the recorder only. Enter a password.

■ Camera selection

Select the camera to which the settings are sent.

Mark the checkbox of the camera to which the set user name and password are sent.

(When "Register camera administrator" is selected in the "Settings", you cannot select cameras whose administrators have already been registered.)

[Transmission] button

Transmit the settings to the camera. Once transmission is completed and the setting has been applied to the camera, "OK" will be displayed in the "Results" field. If the display reads "Authentication error", etc., the camera connection or the setting may have failed.

[Back] button

Click the button after completing the settings. The screen returns to the [Camera registration] tab.

Note:

- The settings can be made from this recorder only for cameras manufactured by us or Panasonic.
- For user name and password, enter those of camera administrator rights according to the specifications of the camera. (Please refer to the operating instructions of the camera.)
- The entered user name and password are set as registered information of the applicable camera when the settings to the camera is completed.
- Click [Exit] button when you set the user name and password.

Change the registered information [Registered information]

Click the [Setup >] button for "Registered information" on the [Camera registration] tab to display the following items.

After editing the settings, click the [OK] button to save the settings and return to the [Camera registration] tab.

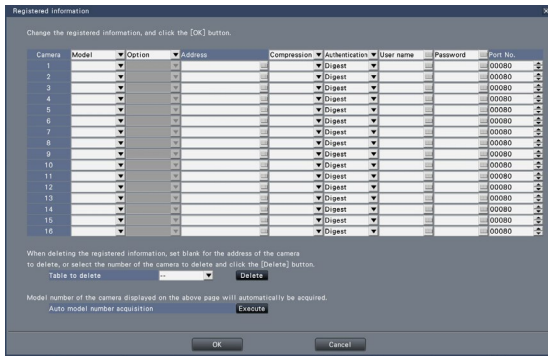

[Camera]

Up to the maximum number of registered cameras per model can be connected.

[Model]

The model of a registered camera will be displayed.

(Blank: Camera is not registered)

Click the [▼] button to select the camera model from Camera part number or the camera categories. Refer to our technical information web site for camera categories.

It is unnecessary to change it for normal use.

[Option]

Assign the operational mode of the camera having a specific function due to the difference in function of the camera.

Note:

- The method of installation will be set to the default values of each mode if the options of the fisheye camera are changed. Please refer to our technical information web site for the default values of each mode.

[Address]

An address already in use will be displayed. The address can be changed using the on-screen keyboard. Enter up to 255 alphanumeric characters including hyphens (-) and periods (.).

Note:

- Entering "http://" is not necessary if the host name is entered.

[Compression]

Select the image compression method.

H.265(1)/ H.265(3)/ H.265(4)/ H.264(1)/ H.264(3)/ H.264(4)/ MJPEG

Note:

- Assignment example by the application of camera stream
 - Recording by compression of H.264, 1-screen live display, browser display: H. 264(1)
 - Recording by compression of H.264, live multi-screen display: H.264(2)
 - Recording by compression of H.264 or H.265, 1-screen live display, browser display: H.264(1), H.264(3), H.264(4), H.265(1), H.265(3), H.265(4)
 - Recording by compression of H.264 or H.265, live multi-screen display: H.264(2), H.265(2)
- If "Do not use stream 2 of camera with each function of this recorder" is switched to ON, H.264(2) and H.265(2) are not used. (Page 39)
- When selecting "MJPEG" for "Compression", the live image transmission rate and the frame rate will be changed automatically to "5 ips". (Page 41)
- When selecting "H.264(n)" or "H.265(n)" for "Compression", it will become possible to select "XF" in the image quality setting. (Page 41)
- Depending on the model of the camera, the camera may reboot when the compression method is changed. The reboot will be detected as a communication error, but that is not a malfunction.

[Authentication]

Set authentication used for the user authentication when accessing the camera.

Digest: Uses digest authentication.

Digest or Basic: Uses either digest or basic authentication.

Default: Digest

[User name]

Enter the user name for accessing the cameras and logging in using the on-screen keyboard. Register the user name whose access level is "Administrator".

[Setup via recorder's main monitor]

[Password]

Enter the password to be used for the user whose name has been registered as "User name" using the on-screen keyboard. (Up to 32 alphanumeric characters)

[Port No.]

Set a port number from 1 - 65535 for use by the camera.

Default: 80

Note:

- Enter the port number in five digits, right aligned. (Example: When the port number is 80, enter "00080".) The leading zeros are omitted here.

[Table to delete]

To delete registration information or remove a previously connected camera, either select the camera number and click the [Delete] button, or delete the IP address of the respective camera.

[Auto model number acquisition]

Click the [Execute] button to acquire the model number from the camera registered for this product and update the model number information.

When the acquired model number is different from the registered one, as the image capture size is changed to the default, reset the image capture size in [REC & event]-[Recording setup] again.

Interchange camera numbers [Change the display position of camera]

Click the [Setup >] button for "Change the display position of camera" on the [Camera registration] tab to display the following items.



The registered camera is displayed on the screen from the left top to right in order of 1, 2, 3, ... To interchange camera numbers, drag the camera image to be moved with the mouse and drop on the desired position. If the camera titles are to be interchanged as well, mark the "Also change camera titles" checkbox.

[Refresh] button

Obtain the latest camera image after interchanging cameras.

[Back] button

Save the settings and return to the [Camera registration] tab.

[Setup via recorder's main monitor]

Select a camera which performs AI privacy guard recording [AI privacy guard recording camera]

Click the [Setup >] button of [AI privacy guard recording camera] on the [Camera registration] tab to display the following screen.

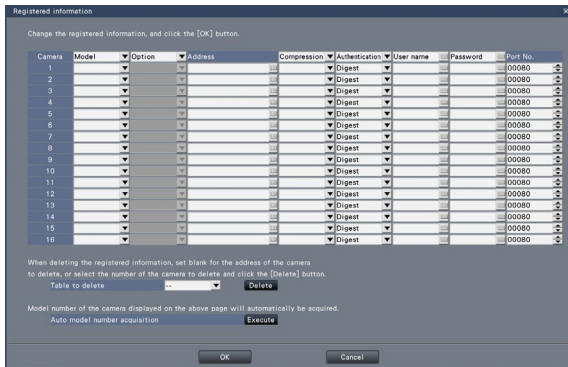

[Recording camera]

For the registered cameras, select a camera to record the AI privacy guard image.

Only cameras that support AI privacy guard recording with the compression method set to H.265 (1) or H.264 (1) can be selected as a recording camera.

[Select]

Select a camera to operate with useful functions.

[Assigned as starting camera no.]

Specify the starting camera no. when assigning camera no. in order. Click the [Execute] button to assign the unused camera no. to the selected cameras in ascending order from the specified camera no.

Note:

- The camera no. selected on the recording camera changes to the AI privacy guard recording display on all settings screens of this recorder, as shown in the following screen.

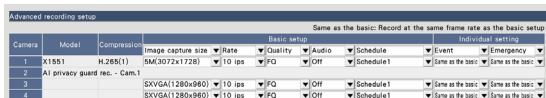

- Select the camera and then click the [Clear] button to clear the assigned camera no.
-

[Camera setup] tab

Transmit the date & time and text displayed on an image, the refresh rate, the VMD alarm and the Light control mode etc. settings to the camera. Click the [Setup >] button for each item to open the respective setup window.

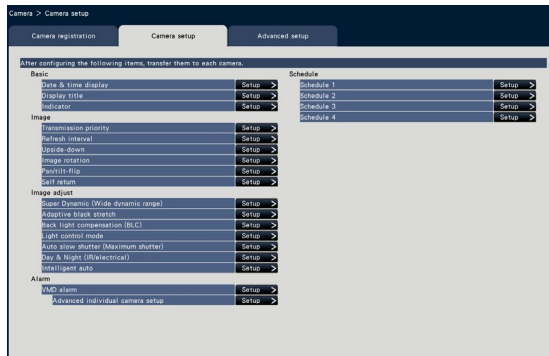

Note:

- The settings can be made from this recorder only for some cameras manufactured by us and Panasonic. Refer to our support website for the supported cameras. Some functions are not supported depending on the models of the connected cameras. For further information about detailed specifications, refer to the operating instructions of the cameras in use.
- It is impossible to check the current settings using this recorder.

Set up date & time display [Date & time display]

Select the date & time display position for each camera and transmit it to the cameras to change the camera settings.

Clicking the [Setup >] button for "Date & time display" on the [Camera setup] tab will display the following items.

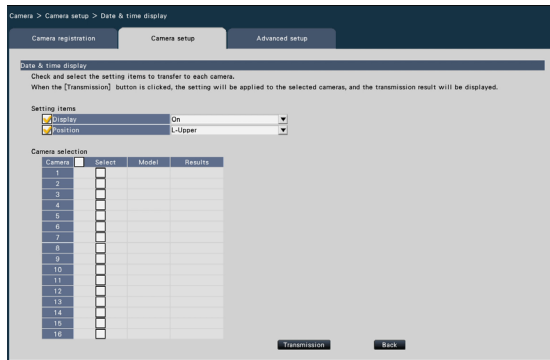

■ Setting items

[Display]

Choose whether or not to display the date & time. If date & time display is activated, date & time will be displayed on camera images and will also be recorded with the recorded images.

To transmit the settings to the camera, mark this item, and select either of the following.

On: Date & time displayed

Off: Date & time not displayed

Note:

- The display format corresponds to the settings on the [Date & time settings] tab (Page 11).
-

[Position]

Select the position to display the date & time on the images.

If the setting is to be transmitted to the camera, mark this item to select the display position.

L-Upper/ L-Lower/ R-Upper/ R-Lower

■ Camera selection

Select the camera to which the date & time display setting is to be sent. Mark the checkbox of the camera to which the setup information is to be transmitted.

[Transmission] button

Transmit the date & time setting to the camera.

Once transmission is completed and the setting has been applied to the camera, "OK" will be displayed in the "Results" field. If the display reads "Authentication error", etc., the camera connection or the setting may have failed.

[Back] button

Click the button after completing the settings. The screen returns to the [Camera setup] tab.

Set up OSD [Display Title]

Determine whether to display the title and select the title to display for each camera, the settings will be changed after the settings have been transmitted to the camera.

Clicking the [Setup >] button for "Display Title" on the [Camera setup] tab will display the following items.

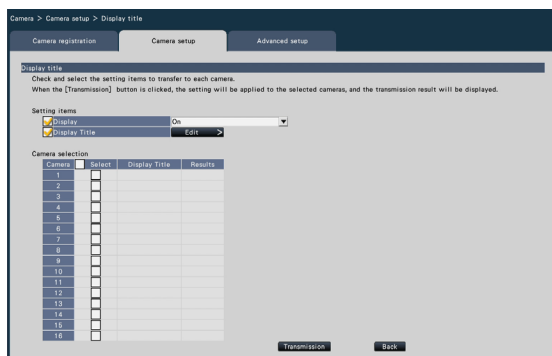

■ Setting items

[Display]

Select whether or not to display the title on camera images. If title display is activated, the title will be displayed on camera images and will also be recorded with the recorded images.

To transmit the settings to the camera, mark this item, and select either of the following.

On: Title displayed

Off: Title not displayed

[Display Title]

To transmit the settings to the camera, mark this item, and edit the title displayed on the image.

Clicking the [Edit >] button will display the following title editing window:

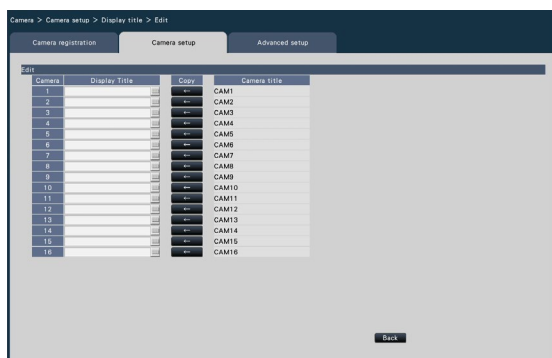

• [Display Title]

Enter a character string to be displayed on the image using the on-screen keyboard. (Up to 16 alphanumeric characters)

Available characters: 0-9, A-Z, ! # \$ % () * + , - . / : ; = ?

• [Camera title]

Display the camera title registered on the [Main monitor] tab of the monitor page (Page 52).

• [Copy] button

The camera title registered on the [Main monitor] tab of the monitor page can be used as display title. Clicking this button will copy the camera title to the "Display Title" field.

• [Back] button

Click the button after completing the settings. This will close the window.

■ Camera Selection

Select the camera to which the setting of the "Display title" is to be sent.

Mark the checkbox of the camera to which the setup information is to be transmitted.

[Transmission] button

Transmit the setting of the "Display title" to the camera.

Once transmission is completed and the setting has been applied to the camera, "OK" will be displayed in the "Results" field.

If the display reads "Authentication error", etc., the camera connection or the setting may have failed.

[Back] button

Click the button after completing the settings. The screen returns to the [Camera setup] tab.

Set up how to turn on or off the indicators [Indicator]

Select how to turn on or off the link indicator, access indicator or status indicators for each camera and transmit the information to the cameras to change the camera settings. Refer to the operating instructions of the camera for further information.

Clicking the [Setup >] button for "Indicator" on the [Camera setup] tab will display the setup page.

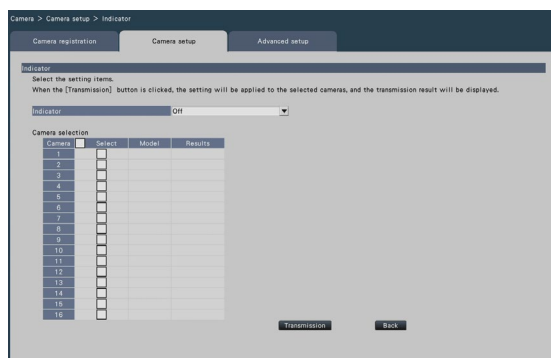

[Indicator]

On: All the indicators will light in accordance with the status.

On (Access): Only the live indicator will light when images are viewed.

Off: All the indicators will light off.

■ Camera Selection

Select the camera to which the "Indicator" setting is to be sent.

Mark the checkbox of the camera to which the setup information is to be transmitted.

[Transmission] button

Transmit the setting of the "Indicator" to the camera. Once transmission is completed and the setting has been applied to the camera, "OK" will be displayed in the "Results" field.

If the display reads "Authentication error", etc., the camera connection or the setting may have failed.

[Back] button

Click the button after completing the settings. The screen returns to the [Camera setup] tab.

Set the camera image transmission priority [Transmission priority]

Select the transmission priority setting for each camera and transmit the information to the cameras to change the camera settings.

Clicking the [Setup >] button for "Transmission priority" on the [Camera setup] tab will display the setup page.

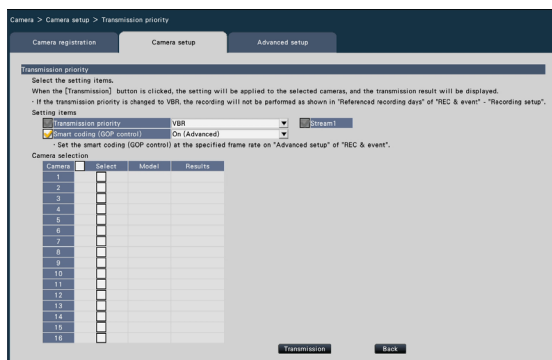

■ Setting items

[Transmission priority]

Select the transmission mode for H.264/H.265 images from the following.

Frame rate: H.264/H.265 images will be transmitted with the frame rate specified in "Frame rate".

Advanced VBR: H.264 images will be transmitted with the frame rate specified in "Frame rate". When this parameter is selected, this product transmits images while adjusting the average of transmission amount in the period specified in "Control time period" to match it to the specified bit rate. The "Transmission priority" will be configured based on the markings of the checkboxes of "Stream1" and "Stream2".

VBR: Transmits H.264/H.265 images with the frame rate specified in "Frame rate" and the image quality level specified in "Image quality" kept. The image quality is fixed and the storage capacity varies according to the "Image quality" setting and conditions of the object.

Note:

- Set up the transmission mode again when the camera is changed on the camera registration screen or change of the camera is detected.

[Burst tolerance level]

Select the allowance of "Max bit rate (per client)" for the H.264 bit rate from the following when the transmission priority is "Advanced VBR".

High, Middle, Low

[Control time period]

Select the period of controlling H.264 bit rate to be recorded from the following when the transmission priority is "Advanced VBR".

1 h, 6 h, 24 h, 1 week

[Priority setting]

Set which to prioritize, the "Frame rate" or the "Image quality", when the transmission priority is the "Frame rate".

Frame rate priority: Prioritizes the frame rate. The image quality may vary according to the object.

Image quality priority: Reduces the change in the image quality. The frame rate may be slower depending on the object.

[Smart coding (GOP control)]

Set whether to use the GOP control or not when the transmission priority is set to the "VBR".

Off: Does not use the GOP control.

On (Advanced): Can reduce the data amount when the motion in the image is less.

■ Camera Selection

Select the camera to which the setting of the "Transmission priority" is to be sent.

Mark the checkbox of the camera to which the setup information is to be transmitted.

Note:

- The cameras that perform AI privacy guard are set to both streams.
-

[Transmission] button

Transmit the setting of the "Transmission priority" to the camera.

Once transmission is completed and the setting has been applied to the camera, "OK" will be displayed in the "Results" field.

If the display reads "Authentication error", etc., the camera connection or the setting may have failed.

[Back] button

Click the button after completing the settings. The screen returns to the [Camera setup] tab.

Set up the refresh interval [Refresh interval]

Select the image refresh interval for each camera and transmit it to the cameras to change the camera settings. Clicking the [Setup >] button for "Refresh interval" on the [Camera setup] tab will display the setup page.

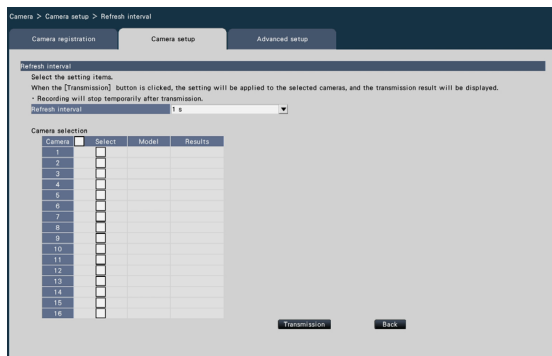

Important:

- Image transmission from the camera will temporarily be canceled and no image will be recorded during this period if the setting to change the refresh interval is transmitted to the camera.

[Refresh interval]

Select an interval to update the image display. If used in a network environment where frequent errors occur, shorten the refresh interval to reduce image distortions. However, the refresh interval may be longer than the set value.

0.2 s / 0.5 s / 1 s / 2 s / 3 s

Note:

- Set up the refresh interval again when the camera is changed on the camera registration screen or change of the camera is detected.

■ Camera Selection

Select the camera to which the setting of the "Refresh interval" is to be sent.

Mark the checkbox of the camera to which the setup information is to be transmitted.

Note:

- The cameras that perform AI privacy guard are set to both streams.

[Transmission] button

Transmit the setting of the "Refresh interval" to the camera.

Once transmission is completed and the setting has been applied to the camera, "OK" will be displayed in the "Results" field.

If the display reads "Authentication error", etc., the camera connection or the setting may have failed.

[Back] button

Click the button after completing the settings. The screen returns to the [Camera setup] tab.

Set up the method of camera installation [Upside-down]

Select the method of installation for each camera and transmit the information to the cameras to change the camera settings.

Clicking the [Setup >] button for "Upside-down" on the [Camera setup] tab will display the setup window.

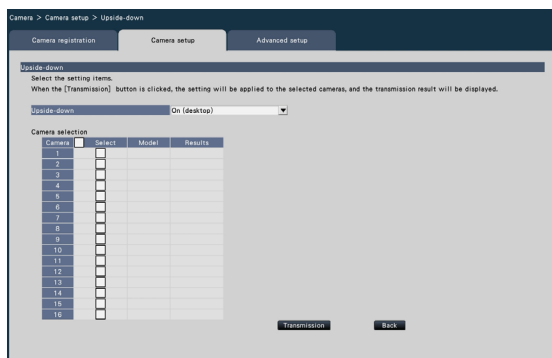

[Upside-down]

On (desktop): Select this when the camera is to be installed with the dome side up.

Off (ceiling): Select this when the camera is to be installed with the dome side down.

Wall: Select this when the camera is to be installed on a wall.

■ Camera Selection

Select the camera to which the setting of the "Upside-down" is to be sent.

Mark the checkbox of the camera to which the setup information is to be transmitted.

[Transmission] button

Transmit the setting of the "Upside-down" to the camera.

Once transmission is completed and the setting has been applied to the camera, "OK" will be displayed in the "Results" field.

If the display reads "Authentication error", etc., the camera connection or the setting may have failed.

[Back] button

Click the button after completing the settings. The screen returns to the [Camera setup] tab.

Note:

- To flip the camera image vertically, select the "Off (ceiling)".
 - If a fisheye camera is registered, "Off (ceiling)" will be set. Select "Wall" to install the camera on the wall.
-

Set the image rotation of camera [Image rotation]

Select the image rotation for each camera and transmit it to the camera to change the camera settings. Clicking the [Setup >] button for "Image rotation" on the [Camera setup] tab will display the setup window.

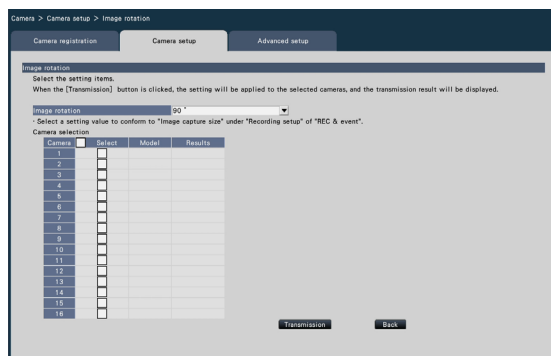

[Image rotation]

- 0 °(Off): Does not rotate the image.
- 90 °: Rotates the image by 90 °.
- 180 °(Upside-down): Inverses the image upside-down.
- 270 °: Rotates the image by 270 °.

■ Camera Selection

Select the camera to which the setting of the "Image rotation" is to be sent. Mark the checkbox of the camera to which the setup information is to be transmitted.

[Transmission] button

Transmit the setting of the "Image rotation" to the camera.

Once transmission is completed and the setting has been applied to the camera, "OK" will be displayed in the "Results" field.

If the display reads "Authentication error", etc., the camera connection or the setting may have failed.

[Back] button

Click the button after completing the settings. The screen returns to the [Camera setup] tab.

Set up pan/tilt-flip [Pan/tilt-flip]

Select the pan/tilt-flip function for each camera and transmit the information to the cameras to change the camera settings.

Clicking the [Setup >] button for "Pan/tilt-flip" on the [Camera setup] tab will display the setup page.

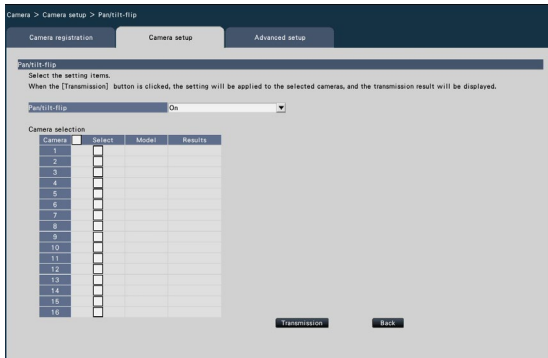

[Pan/tilt-flip]

Select whether or not to activate the pan/tilt-flip function that can achieve camera controllability equal to 360° endless cameras.

On: The pan/tilt-flip function will work.

Off: The pan/tilt-flip function will not work.

■ Camera Selection

Select the camera to which the setting of the "Pan/tilt-flip" is to be sent.

Mark the checkbox of the camera to which the setup information is to be transmitted.

[Transmission] button

Transmit the setting of the "Pan/tilt-flip" to the camera.

Once transmission is completed and the setting has been applied to the camera, "OK" will be displayed in the "Results" field.

If the display reads "Authentication error", etc., the camera connection or the setting may have failed.

[Back] button

Click the button after completing the settings.

The screen returns to the [Camera setup] tab.

Set self return [Self return]

Select the self-return function for individual cameras and transfer it to the camera to change the camera settings.

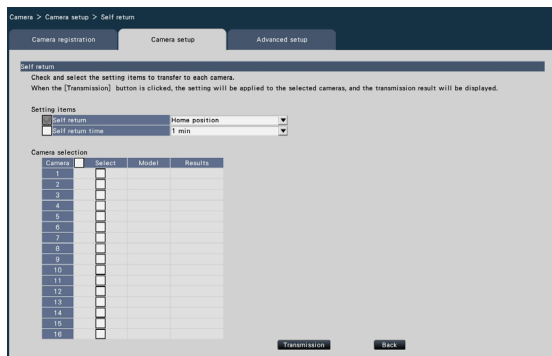

[Self return]

After the manual operation is completed, once the time set by the "Self return time" is passed, any of the selected camera operation modes will be automatically returned.

Off: Do not perform self return.

Home position: Return to home position as soon as the set time elapses.

Auto track: Return to home position and begin auto-track (auto rear-ending) operation as soon as the set time elapses. After that, the operation of returning to home position and beginning auto-track (auto rear-ending) after a certain period of time is repeatedly executed.

Auto pan: Begin auto-pan operation as soon as the set time elapses.

Preset sequence: Sorting operation begins as soon as the set time elapses.

Patrol: Patrol operation begins as soon as the set time elapses.

[Self return time]

After the manual operation is completed, select the deadline time to return to the "Self return" setting from the following items.

10 s / 20 s / 30 s / 1 min / 2 min / 3 min / 5 min / 10 min / 20 min / 30 min / 60 min

■ Camera selection

Select the camera that transfers the self return setting. In the setting items, check the camera that transfers the selected content.

[Transmission] button

Transmit the setting of the "Self return" to the camera.

Once transmission is completed and the setting has been applied to the camera, "OK" will be displayed in the "Results" field.

If the display reads "Authentication error", etc., the camera connection or the setting may have failed.

[Back] button

Click the button after completing the settings. The screen returns to the [Camera setup] tab.

Set up Super Dynamic [Super Dynamic (Wide dynamic range)]

Select the Super Dynamic function for each camera and transmit the information to the cameras to change the camera settings.

Clicking the [Setup >] button for "Super Dynamic (Wide dynamic range)" on the [Camera setup] tab will display the setup page.

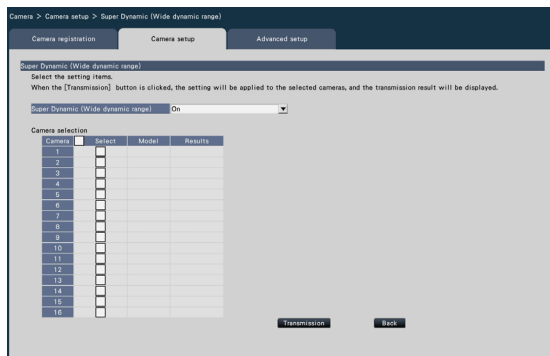

[Super Dynamic (Wide dynamic range)]

Select "On" or "Off" to determine whether or not to activate the super dynamic function.

On (High): The super dynamic function will work.

When "On (High)" is selected, the tone level will be compensated to emphasize the contrast.

On: The super dynamic function will work. When "On" is selected, the tone level will be compensated to emphasize the sensitivity.

Off: The super dynamic function will not work.

■ Camera Selection

Select the camera to which the setting of the "Super Dynamic" is to be sent.

Mark the checkbox of the camera to which the setup information is to be transmitted.

[Transmission] button

Transmit the setting of the "Super Dynamic" to the camera.

Once transmission is completed and the setting has been applied to the camera, "OK" will be displayed in the "Results" field.

If the display reads "Authentication error", etc., the camera connection or the setting may have failed.

[Back] button

Click the button after completing the settings.

The screen returns to the [Camera setup] tab.

Set the adaptive black stretch function of the camera [Adaptive black stretch]

Determine whether to enable the adaptive black stretch function for each camera. The settings will be changed after the settings have been transmitted to the camera.

Clicking the [Setup >] button for "Adaptive black stretch" on the [Camera setup] tab will display the setup window.

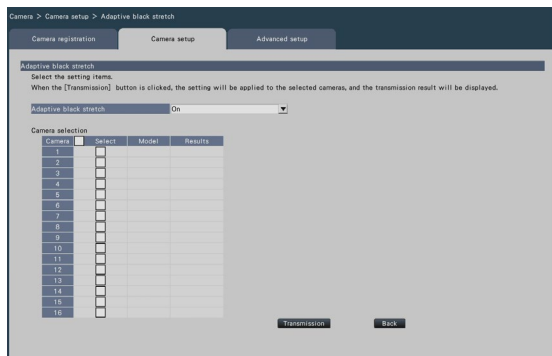

Important:

- When "On" is selected for "Adaptive black stretch", noise in dark area in image may increase and the periphery of the border between the dark area and the bright area will be displayed brighter/darker than the other brighter/darker area in the image.

[Adaptive black stretch]

By using the adaptive black stretch function, dark area in the image will turn brighter by the digital image processing.

On: The adaptive black stretch function will be enabled.

Off: The adaptive black stretch function will be disabled.

Reset: returns the adaptive black stretch setting to the default.

Value: Adjusts brightness of a dark area in an image.

■ Camera Selection

Select the camera to which the setting of the "Adaptive black stretch" is to be sent.

Mark the checkbox of the camera to which the setup information is to be transmitted.

[Transmission] button

Transmit the setting of the "Adaptive black stretch" to the camera.

Once transmission is completed and the setting has been applied to the camera, "OK" will be displayed in the "Results" field.

If the display reads "Authentication error", etc., the camera connection or the setting may have failed.

[Back] button

Click the button after completing the settings. The screen returns to the [Camera setup] tab.

Set the back light compensation function of the camera [Back light compensation (BLC)]

Determine whether to enable the back light compensation function for each camera. The settings will be changed after the settings have been transmitted to the camera.

Clicking the [Setup >] button for "Back light compensation (BLC)" on the [Camera setup] tab will display the setup window.

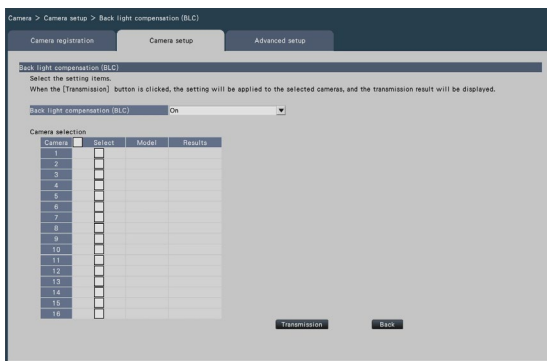

[Back light compensation (BLC)]

When "On" is selected for "Super Dynamic", this function is not available.

The back light compensation function masks the brighter area in image and compensates exposure in silhouette created by back light.

On: Mask area will automatically be set.

Off: Mask area will not be set automatically. It is necessary to set mask areas manually.

■ Camera Selection

Select the camera to which the setting of the "Back light compensation (BLC)" is to be sent.

Mark the checkbox of the camera to which the setup information is to be transmitted.

[Transmission] button

Transmit the setting of the "Back light compensation (BLC)" to the camera.

Once transmission is completed and the setting has been applied to the camera, "OK" will be displayed in the "Results" field.

If the display reads "Authentication error", etc., the camera connection or the setting may have failed.

[Back] button

Click the button after completing the settings.

The screen returns to the [Camera setup] tab.

Set up Light control mode [Light control mode]

Select how to control the amount of light for each camera and transmit the information to the cameras to change the camera settings.

Clicking the [Setup >] button for "Light control mode" on the [Camera setup] tab will display the setup page.

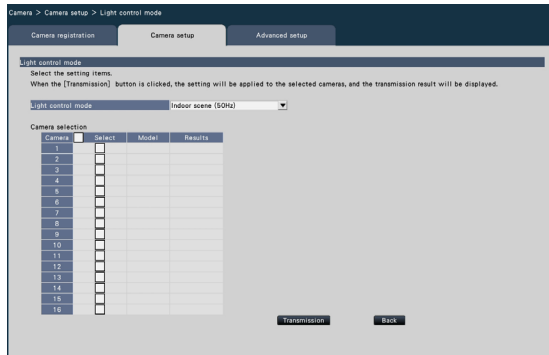

[Light control mode]

Outdoor scene: Depending on the brightness level (illuminance), the iris will automatically be controlled together with the shutter speed adjustment to control light.

Indoor scene (50Hz): The shutter speed will automatically be adjusted to prevent flicker caused by fluorescent light. (For the 50 Hz areas)

Indoor scene (60Hz): Same as "Indoor scene" above. (For 60 Hz areas)

ELC: The iris will automatically be controlled with the shutter speed adjustment to control light.

■ Camera Selection

Select the camera to which the setting of the "Light control mode" is to be sent.

Mark the checkbox of the camera to which the setup information is to be transmitted.

[Transmission] button

Transmit the setting of the "Light control mode" to the camera.

Once transmission is completed and the setting has been applied to the camera, "OK" will be displayed in the "Results" field.

If the display reads "Authentication error", etc., the camera connection or the setting may have failed.

[Back] button

Click the button after completing the settings. The screen returns to the [Camera setup] tab.

Note:

- When "Outdoor scene" is selected, flicker may occur when a subject is under fluorescent lighting.

Set the automatic slow shutter of the camera [Auto slow shutter (Maximum shutter)]

Select the auto slow shutter setting for each camera and transmit the information to the cameras to change the camera settings.

Clicking the [Setup >] button for "Auto slow shutter (Maximum shutter)" on the [Camera setup] tab will display the setup page.

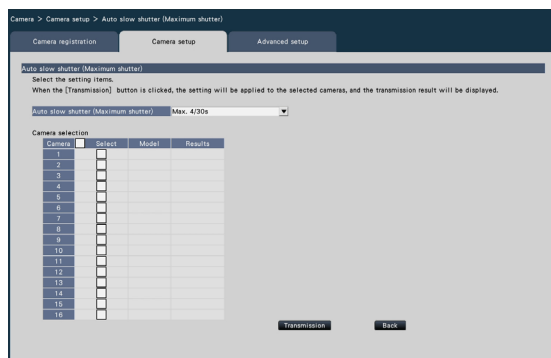

Note:

- When "Max. 16/30s" is selected, the electronic sensitivity will automatically be enhanced up to 16 times.
- When "Off" is selected for "AGC", this function is not available. Refer to the operating instructions of the camera for further information.

[Auto slow shutter (Maximum shutter)]

The auto slow shutter adjusts the sensor storage time to enhance the electronic sensitivity.

The following are available setting values.

Off (1/30s)/ Max. 2/30s/ Max. 4/30s/ Max. 6/30s/
Max. 10/30s/ Max. 16/30s

■ Camera Selection

Select the camera to which the setting of the "Auto slow shutter" is to be sent.

Mark the checkbox of the camera to which the setup information is to be transmitted.

[Transmission] button

Transmit the setting of the "Auto slow shutter" to the camera.

Once transmission is completed and the setting has been applied to the camera, "OK" will be displayed in the "Results" field.

If the display reads "Authentication error", etc., the camera connection or the setting may have failed.

[Back] button

Click the button after completing the settings.

The screen returns to the [Camera setup] tab.

Important:

- When the auto slow shutter is set, the frame rate may drop. Noise or white dots (scratches) may also be seen in image.

Set the black and white switchover of the camera [Day & Night (IR/electrical)]

Select the day and night setting for each camera and transmit the information to the cameras to change the camera settings.

Clicking the [Setup >] button for "Day & Night (IR/electrical)" on the [Camera setup] tab will display the setup window.

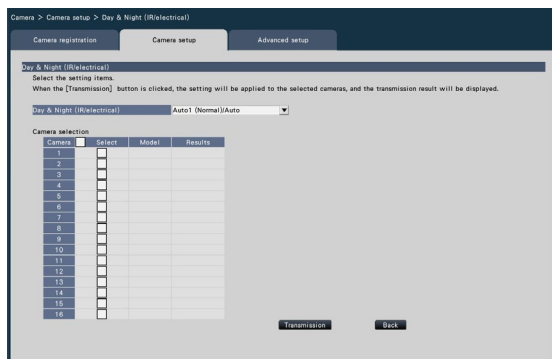

[Day & Night (IR/electrical)]

Select a method of how to switch between B/W image and color image from the following.

Off: Color images will always be taken.

On: B/W images will always be taken.

On (IR Light On): B/W images will always be taken. Use it at night time or using near-IR lighting.

Auto1 (Normal)/Auto: Depending on the image brightness (illuminance), the system automatically switches from/ to the color image to/from B/W image.

It switches to the color mode when the light source is bright and to the monochrome mode when the light source is not bright.

Auto2 (IR Light): Use it at night time or when using near-IR light source.

Auto3 (Super Chroma Compensation (SCC)): Use it if you want to keep the color image even if the light source is not bright. Super Chroma Compensation (SCC) function keeps the color image under the lower illuminance than "Auto1 (Normal)".

Note:

- "On", "Auto2" and "Auto3" can be selected for cameras having "Day & Night (electrical)" only, but they are not operable.

■ Camera Selection

Select the camera to which the setting of the "Day & Night (IR/electrical)" is to be sent.

Mark the checkbox of the camera to which the setup information is to be transmitted.

[Transmission] button

Transmit the setting of the "Day & Night (IR/electrical)" to the camera.

Once transmission is completed and the setting has been applied to the camera, "OK" will be displayed in the "Results" field.

If the display reads "Authentication error", etc., the camera connection or the setting may have failed.

[Back] button

Click the button after completing the settings.

The screen returns to the [Camera setup] tab.

Set the intelligent auto of camera [Intelligent auto]

Select the intelligent auto for each camera and transmit it to the camera to change the camera settings. Clicking the [Setup >] button for "Intelligent auto" on the [Camera setup] tab will display the setup window.

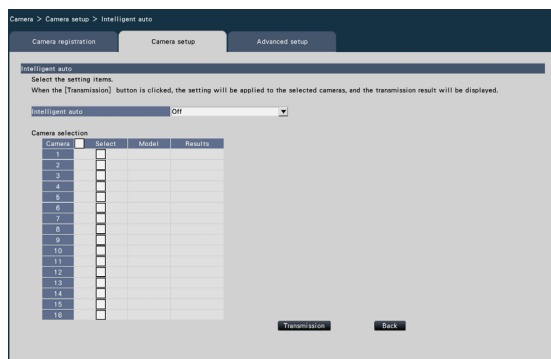

[Intelligent auto]

Set whether or not to turn on the intelligent auto function. The intelligent auto is a function to judge the scene (back light, outside, night view), people's faces, objects in motion, stop the lens down automatically and adjust the shutter speed and contrast to improve visibility of people's faces and objects in motion.

Off: Does not use the intelligent auto function

On: Uses the intelligent auto function

■ Camera Selection

Select the camera to which the setting of the "Intelligent auto" is to be sent. Mark the checkbox of the camera to which the setup information is to be transmitted.

[Transmission] button

Transmit the setting of the "Intelligent auto" to the camera.

Once transmission is completed and the setting has been applied to the camera, "OK" will be displayed in the "Results" field.

If the display reads "Authentication error", etc., the camera connection or the setting may have failed.

[Back] button

Click the button after completing the settings. The screen returns to the [Camera setup] tab.

Set up VMD alarm [VMD alarm]

Select the VMD function for each camera and transmit the information to the cameras to change the camera settings.

Clicking the [Setup >] button for "VMD alarm" on the [Camera setup] tab will display the setup page.

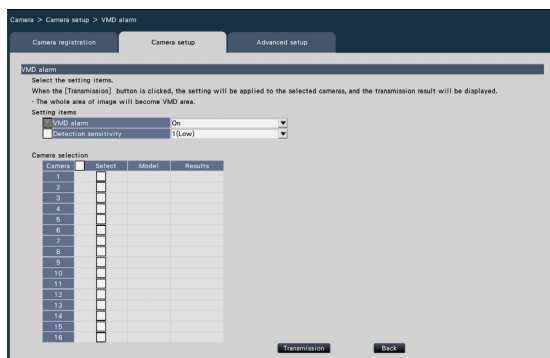

[VMD alarm]

Select whether or not to use the VMD (VMD: Video Motion Detection) alarm function when a change (movement) is detected in the image. Refer to the operating instructions of the camera in use for how to configure the VMD alarm.

On: Detects alarms.

Off: Does not detect alarms.

[Detection sensitivity]

To transmit the settings to the camera, mark this item, and select either of the following.

1(Low) - 15(High)

■ Camera Selection

Select the camera to which the setting of the "VMD alarm" is to be sent. Mark the checkbox of the camera to which the setup information is to be transmitted.

[Transmission] button

Transmit the setting of the "VMD alarm" to the camera.

Once transmission is completed and the setting has been applied to the camera, "OK" will be displayed in the "Results" field. If the display reads "Authentication error", etc., the camera connection or the setting may have failed.

[Back] button

Click the button after completing the settings. The screen returns to the [Camera setup] tab.

Set up VMD alarm for individual cameras [VMD alarm (Advanced individual camera setup)]

Select the motion detection area and detection sensitivity for each camera and transmit the information to the cameras to change the camera settings.

Clicking the "Advanced individual camera setup" [Setup >] button for "VMD alarm" on the [Camera setup] tab will display the setup page.

Note:

- This menu collects setting information from the selected camera and applies it on the setting screen.
- Only the fisheye network camera can set the "Fisheye" mode.
- The live image of the sub-monitor may not be displayed temporarily depending on the setting of the image capture size of the recorded video.

VMD alarm (Advanced individual camera setup)

Setup VMD area

Specify an area by clicking the top left corner and bottom right corner of the square on the screen.

Areas will be set in numerical order starting from area number 1.

When the [Delete] button is clicked, the designated area will be deleted.

When the [Transmission] button is clicked, the setting will be applied to the selected cameras, and the transmission result will be displayed.

Camera selection: Camera 1

Select a preset position

Model

Error information

Area	1	2	3	4
Status	Off	Off	Off	Off
Detection sensitivity	8	8	8	8

Delete: [Delete] [Delete] [Delete] [Delete]

Transmission Results: [Back]

[Camera selection]

Select the camera for which you want to set the VMD alarm.

[Select a preset position]

If the selected camera is a camera with preset function, the preset position is selected.

[Model] [Error information]

Page 13.

[Setup VMD area]

Click the top left corner and bottom right corner of the square on the screen, set the specified position as area 1, and display the area box. Area will be set in numerical order starting from area number 1. When the [Delete] button is clicked, the designated area will be deleted.

Note:

- Depending on the position of the area box, it is sometimes corrected slightly after the transfer settings.
- If the area box is too small, the area number will not be displayed correctly.

[Status]

When the motion detection area is set to Off, the status of the area will be switched to "Off".

[Detection sensitivity]

Set the sensitivity when moving within the area to be detected.

1 (low) ~ 15 (high)

[Transmission] button

Transmit the setting of the "VMD alarm" to the camera. Once transmission is completed and the setting has been applied to the camera, "OK" will be displayed in the "Results" field. When the Error information is not displayed as "-", it cannot be transferred to the camera.

[Back] button

Click the button after completing the settings. The screen returns to the [Camera setup] tab.

Set schedule [Schedule 1 to Schedule 4]

Click the [Setting>] button for "Schedule 1" to "Schedule 4" in the [Camera setup] tab to display the setup window.

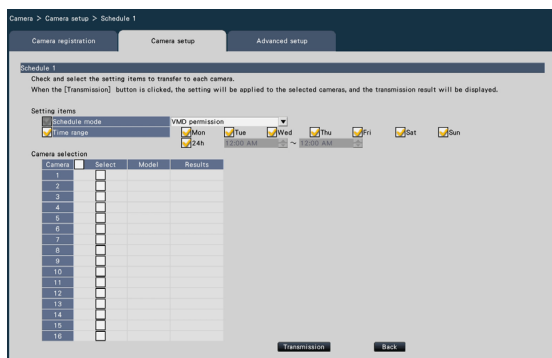

[Transmission] button

Transmit the setting of the "Schedule" to the camera. Once transmission is completed and the setting has been applied to the camera, "OK" will be displayed in the "Results" field. If the display reads "Authentication error", etc., the camera connection or the setting may have failed.

[Back] button

Click the button after completing the settings. The screen returns to the [Camera setup] tab.

[Schedule mode]

Select the schedule operation.

Off: Do not perform the schedule operation.

Alarm permission (Terminal alarm 1,2,3):

Allow the terminal to input an alarm during the set range of the schedule.

Alarm permission (Terminal alarm 1):

Allow Terminal 1 to input an alarm during the set range of the schedule.

Alarm permission (Terminal alarm 2):

Allow Terminal 2 to input an alarm during the set range of the schedule.

Alarm permission (Terminal alarm 3):

Allow Terminal 3 to input an alarm during the set range of the schedule.

VMD permission:

Allow VMD during the set range of the schedule.

Preset position: 1 to Preset position: 8:

After the time is set for the schedule, it moves to the position selected from the preset position registered in advance.

[Schedule]

Check the boxes for the day you want to set the schedule range. Set the start time and the end time when you want to specify a time period. Check "24 h" when the time period is not set.

■ Camera selection

Select the camera to which the setting of the "Schedule" is to be sent. Mark the checkbox of the camera to which the setup information is to be transmitted.

[Advanced setup] tab

Set the connection method of the camera.

Clicking the [Setup >] button of "Connection method" under the [Advanced setup] tab displays the setup screen.

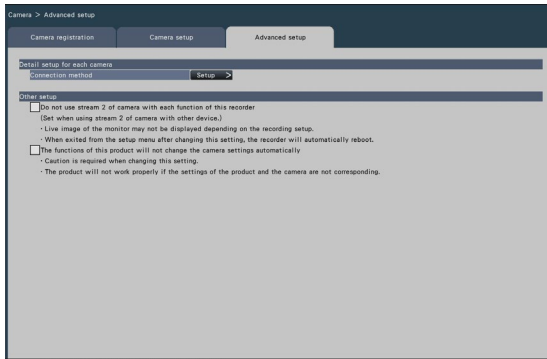

■ Connection method

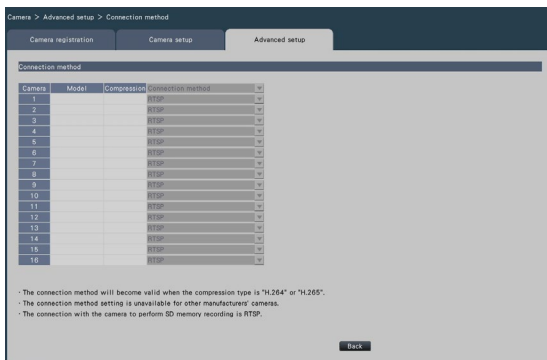

[Connection method]

Set the connection method for each camera.

RTP: Connects with the RTP.

RTSP: Connects with the RTSP. It is used for local camera connection and others.

Internet mode: Connects in the Internet mode. It is used to connect remote cameras or for other connection.

Note:

- The connection method will become valid when the camera is our or Panasonic cameras and the compression type is H.264/H.265.

■ Other setup

[Do not use stream 2 of camera with each function of this recorder.]

If this item is checked, the multi-screen real-time display of the main monitor and sub monitor will also display the stream selected by the recording setup.

Note:

- The live image of the monitor may not be displayed depending on the recording setup.

[The functions of this product will not change the camera settings automatically]

If checked, the camera settings will be automatically configured according to the recording settings of this camera. Normally, do not change this setting since inconsistencies between the settings of the camera and this product may cause various functions not to operate properly.

Important:

- We are not responsible for any damage or trouble that may occur in the user environment as a result of this setting.

Set up recording/events [REC & event]

The "REC & event" page has 3 tabs; the [Recording setup] tab, the [Event setup] tab and the [Advanced setup] tab.

Recording setup tab [Recording setup]

Configure the settings relating to schedule recording. Set the day(s), time table(s), frame rate and image quality for recording.

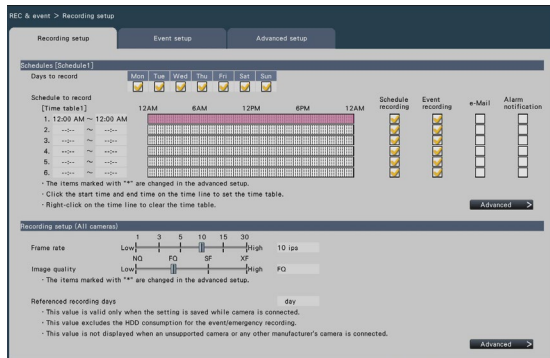

■ Schedules

Recording will be performed according to the schedules set in advance. Select the day(s) of the week and the time table(s).

[Days to record]

Select the day(s) of the week to record. Mark the checkbox(es) of the day(s) of the week to record.

[Schedule to record]

6 time tables can be set up for "[Time table1]". The time bar indicates every 24 hours in steps of 15 minutes. Click the desired position on the time bar to designate the start and end time. When the time is designated, the time bar turns red.

Note:

- At the default, schedule recording and event recording have been set for 24 hours on Time table1. To delete the designated start and end time, right-click the timetable.
- The recording time table can be set by dragging the start and end time on the time bar with the mouse.
- Be sure to set so that there is no overlap between the 6 time tables. When attempting to set the same time as already set on another time bar, the time immediately before or after the overlapping time will be set.
- Within the same time table, event recording has priority over schedule recording.

[Schedule recording]

Mark the checkbox (es) if you want to carry out the schedule recording based on the set time bar.

[Event recording]

Mark the checkbox (es) if you want to carry out event recording based on the set time bar. The recorder does not record the image even if the alarm occurs during time in which the event recording is not set.

[e-Mail]

To send an alarm e-mail when an event occurs, mark this item. The event recording must be checked to set this item.

Refer to "Configure the settings relating to the mail notification [e-Mail]" (☞ Page 58) for the setting of the destination.

[Alarm notification]

Mark the checkbox of this item to automatically transmit information on an event that occurs to a PC using the TCP alarm notification protocol or HTTP. The event recording must be checked to set this item. Refer to "Configure the TCP alarm notification settings [TCP alarm notification]" (☞ Page 59) or "Configure HTTP alarm notification settings [HTTP alarm]" (☞ Page 60) for the setting of the address.

Important:

- If the setting in any one of Schedule 1 to 16 is to notify an alarm notification, notification about camera site alarm inputs (☞ Page 48) will be made even for cameras to which have been allocated the schedules in which alarm notification has not been set.

[Advanced >] button

The "Advanced schedule setup" page will be displayed. In addition to 6 schedule recordings, 6 event recordings can be set up. The schedule settings can be set up to 16 patterns. (☞ Page 42)

■ Recording setup (All cameras)

Set the recording frame rate and image quality. The settings will be applied to all cameras.

[Frame rate]

Select the recording frame rate.

1 ips/ 3 ips/ 5 ips/ 10 ips/ 15 ips/ 30 ips

Default: 10 ips

Important:

- For a camera whose compression method is [MJPEG], "10 ips / 15 ips / 30 ips" cannot be selected.
- If a camera whose compression method is [MJPEG] is included, [MJPEG] camera is set to "5 ips" even if "10 ips / 15 ips / 30 ips" is set by slider bar of frame rate setting. You can confirm the current setting value with [Advanced setup >] in Recording setup (All cameras).

[Image quality]

Select the recording image quality.

NQ (Normal): Standard quality

FQ (Fine): High quality

SF (Super Fine): Super fine quality

XF (Extra Fine): Extra fine quality

Default: FQ

Important:

- For a camera whose compression method is [MJPEG], "XF" cannot be set.
- If a camera whose compression method is [MJPEG] is included, [MJPEG] camera is set to "SF" even if "XF" is set by slider bar of image quality setting. You can confirm the current setting value with [Advanced setup >] in Recording setup (All cameras).

[Referenced recording days]

Calculates and displays the total number of days for which recording on the hard disk drives is available.

Note:

- The referenced recording days will be displayed correctly only when the settings have been saved while the recorder has recognized the camera correctly.
- The referenced recording days will be calculated based on the assumption that recording is started on Monday. The special day settings are not taken into account.
- This value excludes the HDD consumption for the event/emergency recording.
- If a camera manufactured by other than ours is used, the value of "Referenced recording days" will not be displayed.
- "*" preceding an item indicates that the item has been changed on the "Advanced recording setup" page.
- When configured to perform recording in high resolution and high quality, recording may sometimes not be performed at the specified rate. When there may be possibility to fail recording at the specified rate while using only our cameras, the confirmation window will be displayed.
- When the "Auto data delete" (☞ Page 72) is set to other than "Off", the set number of days will be recorded at the same time.

[Advanced >] button

The "Advanced recording setup" will be displayed. Each camera can be set up separately for recording. (☞ Page 43)

Configure the advanced settings for schedule recording [Advanced schedule setup]

Up to 16 schedule patterns can be set. Up to 6 time zones of the schedule recording or event recording can be set for each schedule.

Clicking the [Advanced >] button in the "Schedules" field will open the "Advanced schedule setup" page.



■ Days to record

Select the actions to be taken on each day of the week based on a time table. [●] indicates the selected state, [○] the unselected state.

- Time table1: Recording according to Time table1.
- Time table2: Recording according to Time table2.
- Off: Neither schedule nor event recording will take place.

■ Event recording

Set the recording duration in the event that an alarm occurs and the recording duration before an alarm occurs.

[Event recording duration]

Set the recording duration in the event that an alarm occurs.

- 2 s / 5 s / 10 s / 20 s / 30 s / 1 min / 2 min / 3 min / 5 min / 10 min / 15 min
- Manual: Recording will continue while receiving an alarm input signal. Recording will be performed for at least 8 seconds.
- Ext.: Alarm output will continue until the alarm action is reset.

Default: 30 s

[Pre-event duration]

Set the recording duration before an alarm occurs.

- 0 s / 5 s / 10 s / 15 s

Default: 0 s

Note:

- The actual recording time may sometimes be longer than the duration selected for this setting.

- A 15 second pre-event recording is available when the bit rate setting of the camera is 4 Mbps. Time of the pre-event recording may be shorter than the set time if the image is recorded in high resolution over 4 Mbps, high image quality and high rate.
- Pre-event recording is not performed when "0 s" is selected.
- When images are set to be recorded together with audio, the audio may not be recorded at the beginning of the pre-event recording.

■ Schedule to record

Two time tables can be set.

[Schedule recording] (🔗 Page 40)

[Event recording] (🔗 Page 40)

[e-Mail] (🔗 Page 40)

[Alarm notification] (🔗 Page 40)

[Prev page] / [Next page]

The schedule settings to be configured will be switched over.

[Display the schedule list.]

Display each time table from Schedule 1 to Schedule 16 and settings of the schedule recording, event recording, etc. The schedule list will be displayed when clicking [View] button.

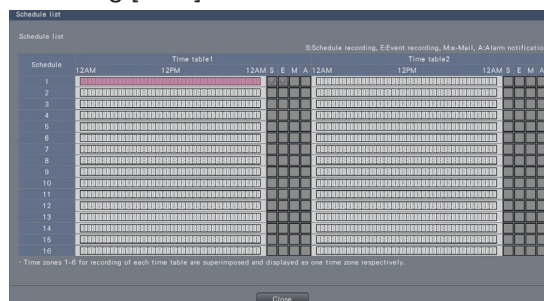

Time zones from 1 to 6 of each time table are superimposed and displayed.

[Back] button

Click the button after completing the settings. The screen returns to the [Recording setup] tab.

Set up recording for individual cameras [Advanced recording setup]

Set up items such as the image capture size, frame rate and image quality for individual cameras.

Clicking the [Advanced >] button on the [Recording setup (All cameras)] tab will open the advanced setup page.

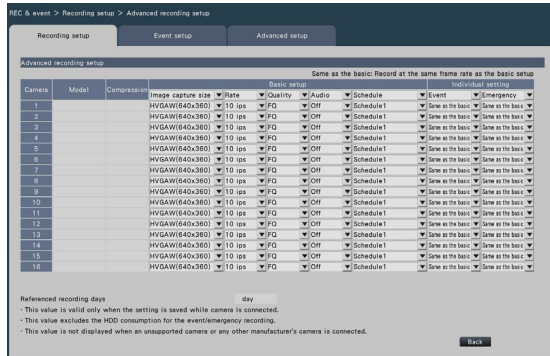

[Model]

The model number of the connected camera will be displayed.

(Blank: Camera is not registered)

[Compression]

The compression method selected when registering camera will be displayed.

[Image capture size]

Select a resolution for images to be recorded.

<When the aspect ratio is 4:3>

VGA(640×480)/ SVGA(800×600)/
SXVGA(1280×960)/ UXGA(1600×1200)/
QXGA(2048×1536)/ 5M(2560×1920)/
7M(3072×2304)

<When the aspect ratio is 16:9>

HVGAW(640×360)/ HD(1280×720)/
FHD(1920×1080)/ WQHD(2560×1440)/
4M(2688×1520)/ 5M(3072×1728)/
6M(3328×1872)/ 4KUHD(3840×2160)

<When the aspect ratio is 1:1>

1.4M(1200×1200)/ 1.6M(1280×1280)/
2M(1440×1440)/ 4M(2048×2048)/
5M(2192×2192)/ 8M(2816×2816)/ 9M(2992×2992)

<When the aspect ratio is 9:16>

0.2M(360×640)/ 1M(720×1280)/ 2M(1080×1920)/
4M(1440×2560)/ 4M(1520×2688)/
5M(1728×3072)/ 6M(1872×3328)/ 8M(2160×3840)

When the aspect ratio is set to portrait resolution, the image is rotated by 90°. If you want to rotate the image by 270°, select 270° at "Set the image rotation of camera [Image rotation]". (Page 26)

Important:

- The available image capture sizes may differ depending on the model of the camera and the compression method.

Note:

- When configured to perform recording in high resolution and high quality, recording may sometimes not be performed at the specified rate.
- Depending on the model of the camera, the camera may reboot when the image capture size is changed. The reboot will be detected as a communication error, but that is not a malfunction.

[Rate] (Frame rate) (Page 41)

Note:

- The 12.5 ips/ 25 ips/ 50 ips/ 60 ips is available depending on the camera model and settings of compression and image capture size.
- The images of "60 ips (50 ips)" can be displayed in one screen if a monitor compatible with 1920×1080 p/ 60 Hz (1920×1080 p/ 50 Hz) is used as a main monitor. (The images on the main monitor other than 1-screen and on the sub monitor are displayed in "30 ips (25 ips)".)

[Quality] (Image quality) (Page 41)

[Audio]

Select whether or not to record audio together with images.

On(AAC-LC): Audio will be recorded.

Off: Audio will not be recorded.

Default: Off

[Schedule]

Select a schedule in which the desired recording to be performed is included.

Schedule1 : Recording will be performed according to the settings for schedule1.

Schedule16: Recording will be performed according to the settings for schedule16.

Default: Schedule1

[Event]

Select the frame rate of the event recording.

1 ips/ 3 ips/ 5 ips/ 10 ips/ 12.5 ips/ 15 ips/ 25 ips/
30 ips/ (Same as the basic)

Default: Same as the basic

[Emergency]

Set the frame rate of the emergency recording.

1 ips/ 3 ips/ 5 ips/ 10 ips/ 12.5 ips/ 15 ips/ 25 ips/
30 ips/ (Same as the basic)

Default: Same as the basic

Note:

- If the rate of the basic settings is 50 ips or 60 ips, the settings of the event recording and the emergency recording will be the same as the rate or the basic setting and displayed as "Same as the basic". In this case, the settings of the event recording and emergency recording cannot be changed.
- The rates of recorded images set to 5 ips/ 10 ips/ 15 ips become 4.2 ips/ 8.3 ips/ 12.5 ips respectively if any of the basic setup, the event recording or the emergency recording of the same camera is set to 12.5 ips or 25 ips.
- If the SD backup rec. or the SD recording function of the camera is used, set the frame rate of the event recording and the emergency recording to "Same as the basic".

[Referenced recording days] (☞ Page 41)

[Back] button

Click the button after completing the settings. The screen returns to the [Recording setup] tab.

Configure event-related settings [Event setup] tab

Configure event-related settings such as the alarm output duration and buzzer duration.

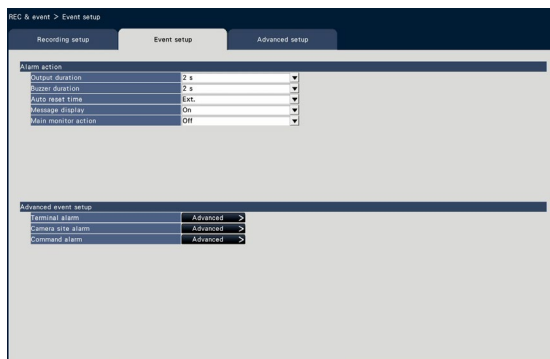

■ Alarm action

Configure alarm-related items such as alarm output duration and alarm auto reset.

[Output duration]

Select the output duration for the alarm signal output from the terminal on the recorder's rear panel when an alarm occurs. When "0 s" is selected, alarm signals will not be output.

0 s/ 2 s/ 5 s/ 10 s/ 20 s/ 30 s/ 1 min

Ext.: Alarm output will continue until the alarm action is reset. Refer to the "Cancel the alarm action" (☞ Page 125) for further information about how to cancel the alarm action.

Rec.: Output of the alarm signal will continue during event recording.

Default: 2 s

[Buzzer duration]

Set the duration of the buzzer sound when an alarm occurs. When "0 s" is selected, the buzzer will not sound.

0 s/ 2 s/ 5 s/ 10 s/ 20 s/ 30 s/ 1 min

Ext.: The buzzer will keep on sounding until the alarm action is reset. Refer to the "Cancel the alarm action" (☞ Page 125) for further information about how to cancel the alarm action.

Rec.: The buzzer will keep on sounding during event recording.

Default: 2 s

[Auto reset time]

Set the time for automatically resetting the alarm action.

2 s/ 5 s/ 10 s/ 20 s/ 30 s/ 1 min/ 3 min/ 5 min

Ext.: The alarm action will not automatically reset. Refer to the "Cancel the alarm action" (☞ Page 125) for further information about how to cancel the alarm action.

Default: Ext.

Note:

- If the time set for "Output duration" or "Buzzer duration" is longer than that set for "Auto reset time", the time set for "Auto reset time" will be applied.
-

[Message display]

Select whether or not to display a message on a PC connected to a network when an alarm occurs.

On: Display a message.

Off: Does not display a message.

Default: On

[Main monitor action]

While the main monitor is displaying the operation window, or in the Wide view display, select whether or not to switch to 1-screen display in association with alarm occurrence.

On: Switch the monitor display in association with alarm occurrence.

On(ACK/RESET): Switches the monitor display linking with the alarm confirmation and resetting.

Off: Does not switch the monitor display.

Default: Off

Note:

- For "On(ACK/RESET)", set the General purpose I/O terminals to "Alarm reset input". (Page 72)
 - When set to "On(ACK/RESET)", the screen will not switch and the same camera image will continue to be displayed even if another alarm occurs during the linked operation. The alarm reset input on the alarm/control terminal switches to another camera. If multiple alarms occur during linked operation, the camera numbers are stored in the order in which they occurred.
 - The images from the camera selected for "Recording camera" of "Advanced setup" are displayed on a 1-screen.
 - The main monitor action will not be activated while recorded images are being played back or the setup menu is being displayed.
 - When the auto reset time have passed, it will return to the previously displayed screen. (When the mouse is operated while the main monitor action is being taken, it will not return to the previously displayed screen.)
-

[Event type]

Displayed when "On" or "On(ACK/RESET)" is selected for "Main monitor action".

A event type to be linked is selected.

[Display]

Displayed when "On" or "On(ACK/RESET)" is selected for "Main monitor action".

It selects the display in which the main monitor action to be displayed.

Ctrl screen: Displays in the Ctrl screen.

Wide view: Displays in the Wide view.

Default: Ctrl screen

[Display camera]

It is displayed when "On" or "On (ACK/RESET)" is selected in "Main monitor action". When using AI privacy guard recording, select whether to display the camera (Recording camera) without privacy guard or the camera (AI privacy guard recording camera) with privacy guard.

Default: Recording camera

■ Advanced event setup

Configure advanced settings for individual alarm types (terminal alarm, camera site alarm, and command alarm). Clicking the [Advanced >] button for each item will open the respective "Advanced setup".

Set up terminal alarm [Advanced terminal alarm setup]

Configure the settings relating to the recording triggered by an alarm signal supplied to the ALARM/CONTROL connector of the recorder from an external alarm device such as a door sensor.

Configure the necessary settings for each alarm input terminal of the ALARM/CONTROL connector on the rear panel of the recorder.

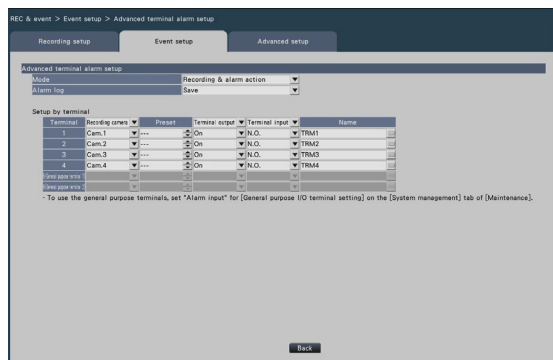

■ Advanced terminal alarm setup

[Mode]

Select the action to be taken when an alarm signal is supplied.

Recording & alarm action: Performs all event actions according to the settings.

Recording only: Only recording, filing of event logs, and moving the camera to a preset position will be performed.

Off: Only filing of event logs will be performed.

Default: Recording & alarm action

[Alarm log]

Determine whether or not to save the alarm log.

Save: Logs will be saved.

Not save: Logs will not be saved.

Default: Save

[Setup by terminal]

Set up alarm input terminal 1 to 4, and general purpose input/output terminal 1 and 2.

Note:

- "Terminal 5" on the setting screen corresponds to terminal 10 (General purpose I/O 1) of the alarm control terminals on the rear panel of this product, and "Terminal 6" corresponds to terminal 11 (General purpose I/O 2) as well. To use this terminal, set it to "Alarm input" in the General purpose I/O terminal setting. (Page 72)

[Recording camera]

Select the camera for recording. When "Off" is selected, recording will not be performed.

Camera 1: Record using camera 1.

⋮

Camera n: Record using camera n.

All: Applies all the registered cameras for recording.

Default: Camera number associated with the terminal number

Note:

- When many cameras are registered and "All" is selected for "Recording camera", the start of alarm recording may be delayed depending on the cameras. It is recommended to perform pre-event recording.

[Preset]

Select the camera preset position (001 to 256) to which the camera is to be moved when an alarm signal is received. If "---" is selected, the camera will not be moved to a preset position.

[Terminal output]

Choose whether or not to output an alarm signal from the alarm output terminal of the ALARM/CONTROL connector on the recorder's rear panel when an alarm signal is received.

On: Outputs the alarm signals from the alarm output terminal.

Off: Does not output alarm signals.

Default: On

[Terminal input]

Select the terminal status for supplying an alarm signal to the alarm terminal.

N.O. (Normally Open): Signals will be supplied when short-circuited.

N.C. (Normally Close): Signals will be supplied when open-circuited.

Default: N.O.

[Name]

Enter the names of terminal alarms 1-6 using the software keyboard (up to 16 characters).

Note:

- The alarm history and the body of e-mail notifications are displayed with the name you set.

[Back] button

Click the button after completing the settings. The screen returns to the [Event setup] tab.

Note:

- Refer to the "Operate the camera" section (📖 Page 118) for further information about the camera preset positions.
-

Set up camera site alarm [Advanced camera site alarm setup]

Set up the action to be taken when a TCP alarm notification received from a camera triggers camera site alarm.

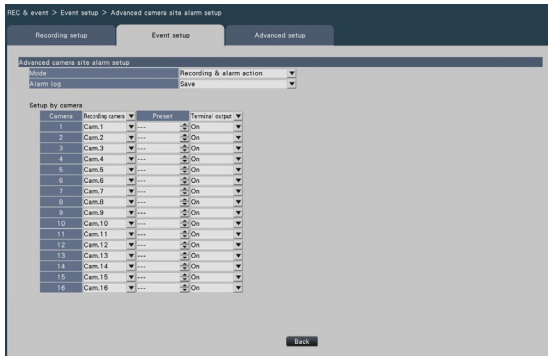

Refer to the "Set up terminal alarm [Advanced terminal alarm setup]" section (Page 46) for further information about the items available for "Advanced camera site alarm setup"; "Mode" and "Alarm log", and also "Recording camera", "Preset", "name" and "Terminal output" under "Setup by camera".

[Back] button

Click the button after completing the settings. The screen returns to the [Event setup] tab.

Note:

- If the event recording time (Page 42) is shorter than alarm deactivation time set from the camera, the event recording may not be done for alarms which continuously occur.

Set up command alarm [Advanced command alarm setup]

Set up the action to be taken when a command alarm signal received from a PC that is connected via a network protocol triggers command alarm.

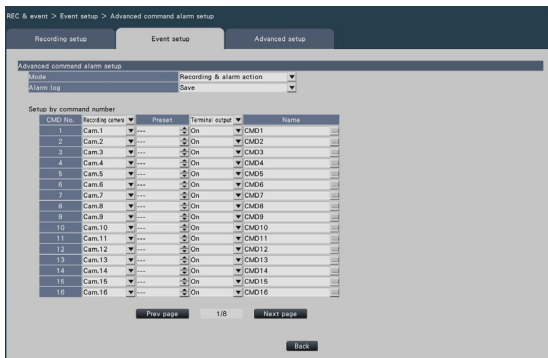

Refer to the "Set up terminal alarm [Advanced terminal alarm setup]" section (Page 46) for further information about the items available for "Advanced command alarm setup"; "Mode" and "Alarm log", and also "Recording camera", "Preset" and "Terminal output" under "Setup by command number".

[Back] button

Click the button after completing the settings. The screen returns to the [Event setup] tab.

Configure the advanced settings for recording and events [Advanced setup]

Configure the special settings related to recording on this tab. Set up the recording mode, alarm disarm duration and TCP alarm port number (the port number for incoming site alarm).

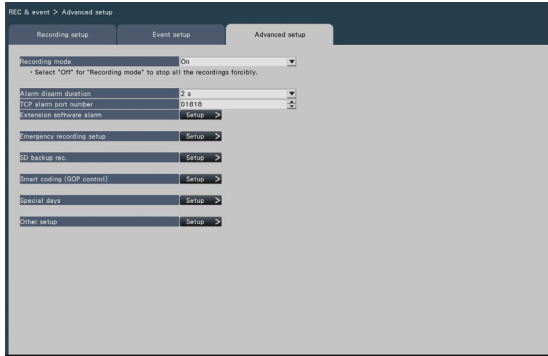

[Recording mode]

Determine whether or not to stop all recording actions. Set to "Off", primarily to stop access to the HDD before turning off the power.

On: Performs recording.

Off: Stops all recording actions.

Default: On

Important:

- If "Off" is selected, be sure to return the setting to "On" when resuming operation.

[Alarm disarm duration]

Set the period to suspend event actions for the case that the same kind of event (terminal alarm, camera site alarm, command alarm) occurs repeatedly at the same camera.

2 s / 3 s / 5 s / 10 s

Default: 2 s

[TCP alarm port number]

Specify the number of the port to be used for receiving site alarm.

Default: 1818

Note:

- Enter the port number in five digits, right aligned. (Example: When the port number is 80, enter "00080".) The leading zeros are omitted here.
- The following numbers, the HTTP port number, the HTTPS port number and the port number of the port forwarding are unavailable.
20, 21, 23, 25, 42, 53, 67, 68, 69, 79, 80, 105, 110, 123, 161, 162, 443, 546, 547, 995, 10001, 10002, 10003, 10004, 10005, 10006, 10007, 50000~50255

[Extension software alarm]

Set the extension software alarm name and message ID.

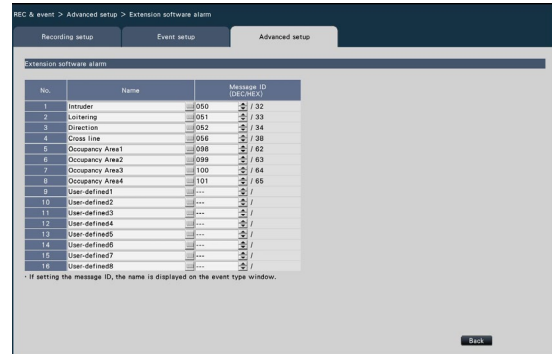

The AI-VMD and AI Occupancy Detection features must have been configured on the target camera to use the enhanced software alarms 1-8.

[Name]

Enter the names of the extension software alarms 1 to 16 from the on-screen keyboard (up to 16 characters).

Note:

- The alarm log, event information display, event type (page 136), and REC event (page 171) are displayed with the set name.
- If the setting is saved in blank, it will return to the default name.

[Message ID]

Select alarm message ID to be received as extension software alarms 1 to 16 in decimal number (000 to 255).

Note:

- When the message ID is set, the set alarm name is displayed in the event type (page 136) and REC event (page 171).

[Emergency recording setup]

Configure the settings related to emergency recording

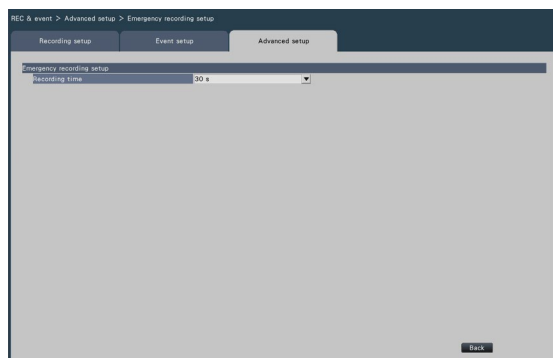

[Recording time]

Select a recording duration for the emergency recording.

30 s/ 1 min/ 3 min/ 5 min/ 10 min/ 15 min/ 30 min

Manual: Records only while the connected external switch is being pressed. It records at least 8 seconds.

Ext.: Alarm output will continue until the alarm action is reset.

For details on canceling the alarm action, refer to the "Cancel the alarm action" (☞ Page 125).

Default: 30 s

[SD backup rec.]

Set whether to save the image on the SD memory card or not when the communication is disconnected during the recording.



On: Uses the SD memory backup function.

Off: Does not use the SD memory backup function.

Default: Off

Important:

- It is recommended to use the SD memory backup function with a wired network connection.

SD backup rec.

The SD memory backup is a function to save images on the SD memory card inserted in the camera when the recorder fails to communicate with the camera during the set recording time.

The SD memory backup is only available if the camera supports the SD memory recording and the compression is set to H.264/H.265.

The SD memory recording is done by the registered compression of the camera.

Note:

- If the camera is set to "Not use" the SD memory card or the SD memory card is not inserted (including insufficient insertion), error messages are displayed some times in a day and recording is paused for about 20 seconds.
- If the SD backup rec. function is used, set the operation mode of the SD memory card to "Overwrite On" from the camera side.

Acquire the image saved on the SD memory card

Acquire the image saved on the SD memory card to the recorder and record it to the HDD.

Acquisition of images from the SD memory card is automatically done a quarter past every hour.

(0:15, 1:15, ...23:15)

You can check whether the recorder is acquiring the SD memory data on the "Status display area".

Important:

- This features saves only image data to the HDD. Audio data and information used in motion detection search are not saved.
- When the recording starting time set on the schedule has arrived without communication between the camera and the recorder, the SD memory backup will not be executed.
- Do not set the SD memory backup function to the same camera from multiple network disk recorders.
- The recording time of the acquired SD memory data will be time of the camera. Adjust time of the camera and the recorder using the NTP function and the camera time auto synchronization function. If time is not adjusted, the SD memory backup may not be available.
- After setting the SD memory backup function to "On", manually acquire the SD backup data from the camera. (☞ Page 75) Beginning the next day, data acquisition will be automatically performed a quarter past every hour.

[Setup via recorder's main monitor]

Note:

- All images may not be acquired at one time due to the time between time tables of the schedule and the total capacity of the images. The remaining images will be acquired at the subsequent acquisition time.
- The image is not acquired during the following cases. Playing the image/HTTP downloading/Emergency recording
- If the following operations occur during acquiring the SD memory data, the acquisition is paused. Communication failure with the camera while acquiring SD memory data/Entering in HDD management page of [Advanced setup]

[Smart coding (GOP control)]

Select when you use the smart coding (GOP control) function of the camera.

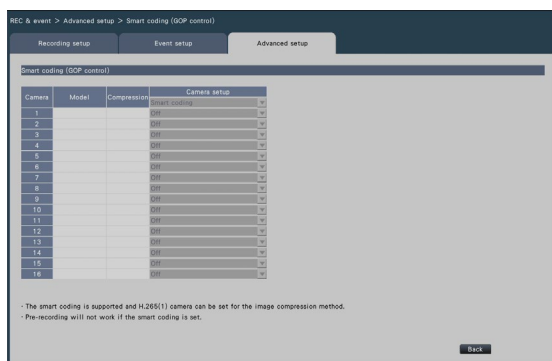

On (Advanced): Uses the smart coding.

Off: Does not use the smart coding.

For more information about this function, refer to the Operating Instructions of your camera.

[Special days]

Assign a schedule of another day individually as a special day.

For example, if you set "January 1st" to "Sunday", the recording will be performed as on Sunday, no matter which day of the week January 1st is actually on.

The following screen of the special day will be displayed when the [Setup >] button is clicked.



[Month] [Day]

Select a date that you want to set as a special day.

[Mode]

Select a day whose schedule you want to use.

Default: None

Other setup

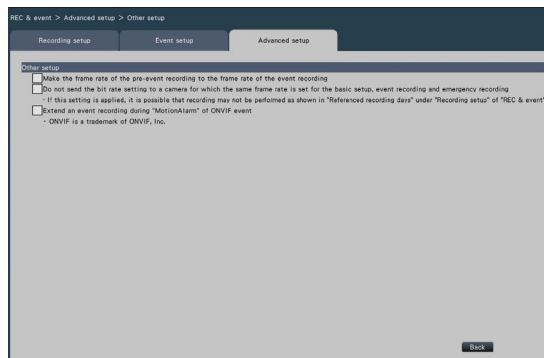

[Make the frame rate of the pre-event recording to the frame rate of the event recording]

Check to set the frame rate of the pre-event recording to the frame rate of the event recording. Uncheck to return the frame rate to the standard settings (the frame rate of the schedule recording). The setting is only effective for our cameras.

[Do not send the bit rate setting to a camera for which the same frame rate is set for the basic setup, event recording and emergency recording]

The bit rate setting is not sent to the camera for which the same frame rate is set for each recording when it is checked. The setting is only effective for our cameras.

[Extend an event recording during "MotionAlarm" of ONVIF event]

When checked, the event recording that starts with "MotionAlarm" in the ONVIF event notified by the camera will be extended for the duration set in the event recording duration (Page 42) unless an end notification is received from the camera.

Note:

- Please be noted that if the communication is temporarily interrupted due to the network environment, the recording will continue until the alarm operation is canceled unless an end notification is received.
- In "Advanced camera site alarm setup" (Page 48), when one camera is set to "Recording Camera" for multiple cameras, it may not work properly.

Configure the settings relating to monitors [Monitor]

The settings relating to the display of the main monitor or sub-monitor connected to the recorder are configured on the setup menu - the "Advanced setup" - the "Monitor" page.

The settings relating to image switching such as multiscreen display and sequence display of live images are also configured on this page.

The "Monitor" page has 3 tabs; the [Main monitor] tab, the [Sub monitor] tab and the [Advanced setup] tab.

Set up the main monitor [Main monitor]

Perform settings relating to the main monitor display such as the display position of the camera title.

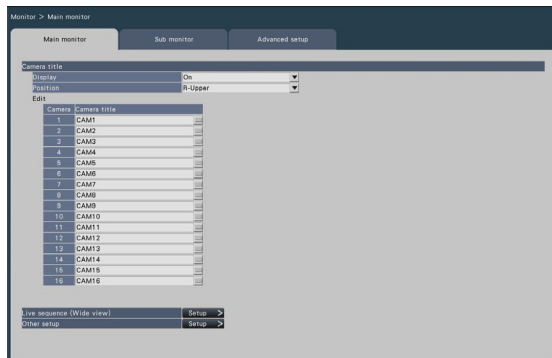

■ Camera title

[Display]

Determine whether or not to display the camera title on the main monitor.

On: Displays the camera title.

Off: Does not display the camera title.

Default: On

[Position]

Select the position to display the camera title on images.

L-Upper/ L-Lower/ R-Upper/ R-Lower

Default: R-Upper

[Camera title]

Enter a camera title to display for each camera using the on-screen keyboard. (Up to 16 characters)

Note:

- When using together with the date and time display to be set on the camera (Page 20) or OSD (Display Title, Page 21), adjust the position to be displayed to not to overlap with them.
- The camera title configured on this setting will not be embedded on recorded images.

■ Live sequence (Wide view)

Set the sequence of the wide view screen on the main monitor.

The following live sequence (Wide view) screen will be displayed when the [Setup >] button is clicked.

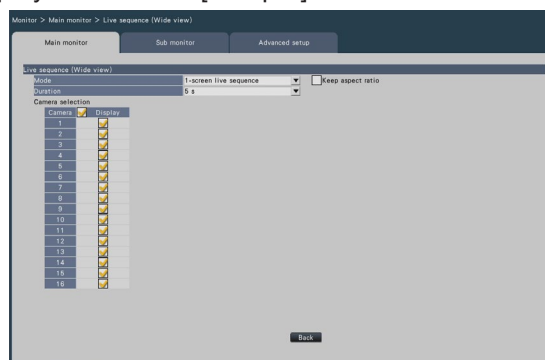

[Mode]

Select a screen pattern of the sequence.

NU300/NU301: 1-screen live sequence, 4-screen live sequence, 9-screen live sequence

NU201: 1-screen live sequence, 4-screen live sequence

NU101: 1-screen live sequence

Default: 1-screen live sequence

[Keep aspect ratio]

Select whether to change the aspect ratio of the displayed area if the aspect ratio of the image is different from the displayed area.

Checked: Keep aspect ratio (Does not change the ratio automatically).

Not checked: Does not keep aspect ratio (Changes the ratio automatically).

Default: Not checked

[Duration]

Set the interval (duration) for switching camera images.

3 s/ 5 s/ 10 s

Default: 5 s

Note:

- Some cameras may take time to display images and the screen may be switched before images are displayed if the duration is short. In that case, set a longer time for the switching interval.

[Camera selection]

Select the cameras to be included in the sequence display.

Mark the checkbox next to the desired camera. The selected cameras will be displayed in numerical order.

Note:

- The number of selected camera is within the number of split screens, it displays without switching the cameras.

[Back] button

Click the button after completing the settings. The screen returns to the [Main monitor] tab.

■ Other setup

Click [Setup >] button to display the following screen.

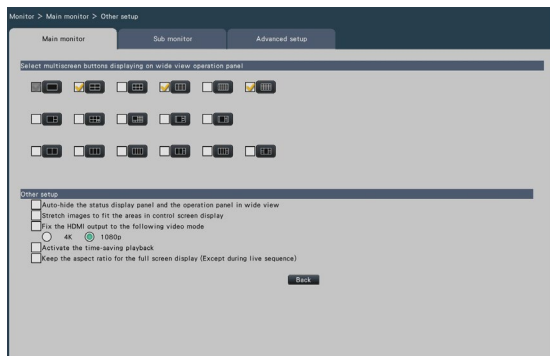
**[Select multiscreen buttons displaying on wide view operation panel]**

The button whose checkbox is marked will be displayed on the wide view operation panel.

■ Other setup**[Auto-hide the status display panel and the operation panel in wide view]**

Mark the checkbox to display or hide the status display panel and the operation panel in wide view in association with whether the mouse cursor is displayed or hidden.

[Stretch images to fit the areas in control screen display]

Mark the checkbox to enlarge the vertical size of images with the aspect ratio of 16:9 to fit into the image display area on the control screen.

Note:

- If the image is expanded by this setting, the camera operation or the motion detection search in the image may not function as the specified coordinates or area.

[Fix the HDMI output to the following video mode]

Fixes the signal system of the HDMI output when it is checked. The signal system is selectable from 4K and 1080p.

Note:

- 4K output is p/30Hz(4K/30p). Depending on your monitor, "ERROR" may be displayed, but you can still use this product without problems.
- Do not select "4K" unless a 4K monitor is connected. Otherwise the monitor will display a black screen or fail to return to the setup menu.

[Activate the time-saving playback]

Mark the checkbox to activate the time-saving playback and play the recorded image up to 4 times faster if there is no movement in the recorded image. (For playback by the operation of the recorder) (Page 135)

Important:

- To use the time-saving playback, a camera that supports the motion detection information addition function is required. For more information about this function, refer to the Operating Instructions of the camera.

Keep the aspect ratio for the full screen display (Except during live sequence)

For "multiscreen select" of each wide view except for live sequence, select whether to change the aspect ratio of the displayed area if the aspect ratio of the image is different from the displayed area.

Checked: Keeps aspect ratio (Does not change the ratio automatically)

Not checked: Does not keep aspect ratio (Changes the ratio automatically)

Default: Not checked

[Back] button

Click the button after completing the settings. The screen returns to the [Main monitor] tab.

Configure the settings relating to sub monitors [Sub monitor]

Set up the sub monitor by selecting the camera images to display, the image display duration, etc.

Important:

- When using a sub-monitor, use a full HD (1080p) monitor for the main monitor, or fix the HDMI output signal format to 1080p. (→ page 53)

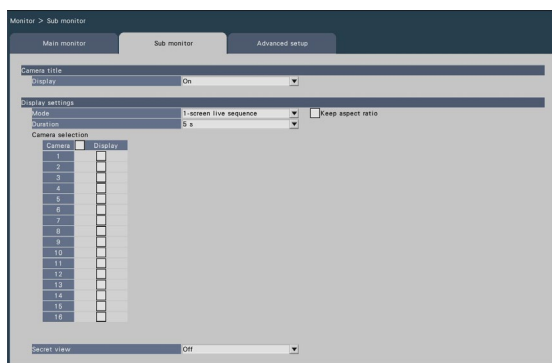

■ Camera title

[Display]

Set whether to display the camera title on the sub monitor.

On: Displays the camera title

Off: Does not display the camera title

Default: On

■ Display settings

Set the display sequence for camera images (image switching).

[Mode]

Select how to display images from the cameras.

1-screen live sequence: Images from the cameras will sequentially be switched and displayed on 1-screen.

4-screen live sequence (NU201/NU300/NU301 only) : Switch between 4 screens.

9-screen live sequence (NU300/NU301 only) : Switch between 9 screens.

Switch by alarm terminal input: The display camera is switched to Cam.1 to 4 respectively according to the input signal of terminal alarm terminal numbers 1 to 4 and displayed on a single screen. When "Alarm input" is set in the General purpose I/O terminal setting, General purpose I/O1 and I/O2 are switched to camera 5 and 6, respectively.

4Screen (NU101 only): Images from the cameras will be displayed on 4Screen without switching the screen.

9Screen (NU201 only): 9 screens are fixed and displayed.

16Screen (NU300/NU301 only): 16 screens are fixed and displayed.

[Keep aspect ratio]

Select whether to change the aspect ratio of the displayed area if the aspect ratio of the image is different from the displayed area.

Checked: Keep aspect ratio (Does not change the ratio automatically)

Not checked: Does not keep aspect ratio (Changes the ratio automatically)

Default: Not checked

[Duration]

Set the interval (duration) for switching camera images.

3 s/ 5 s/ 10 s

Default: 5 s

Note:

- Some cameras may take time to display images and the screen may be switched before images are displayed if the duration is short. In that case, set a longer time for the switching interval.
- Depending on the selection of the camera to be displayed in the sequence, the switching interval of camera images may be extended.

[Camera selection]

Select the cameras to be included in the sequence display.

Mark the checkbox next to the desired camera. The selected cameras will be displayed in numerical order.

Note:

- When displaying a multiscreen display, the selected cameras are displayed aligned from the top.
- The number of selected camera is within the number of split screens, it displays without switching the cameras even if the live sequence is selected.

[Secret view]

Secret view is a function that causes the camera image displayed on a 1-screen or the selected camera image on a multiscreen on the main monitor to be displayed as a black screen on the sub monitor. Determine whether or not to use secret view.

On: Enables the secret view function.

Off: Disables the secret view function.

Default: Off

Note:

- While "1-screen live sequence" is being performed, the secret view images will be skipped (not displayed).
- The image on the sub monitor may momentarily go black when images are switched on the main monitor.

Configure other settings relating to monitors [Advanced setup]

Configure the audio output setting of the monitor and select the video format sent to the sub monitor.

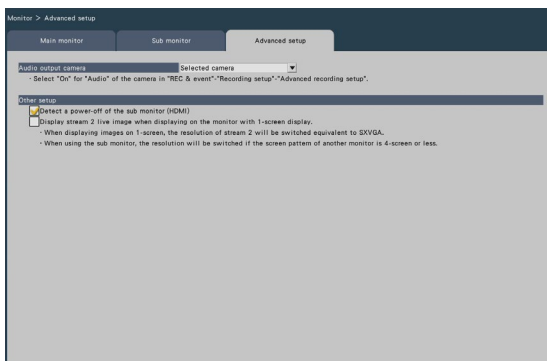

[Audio output camera]

The camera channel whose audio is output from the recorder will be fixed. To fix the camera channel, select the camera whose audio is to be output from the recorder.

Selected camera: Does not fix the camera channel (The recorder will output the audio of the camera whose images are being displayed.)

Cam.1 - Cam.n: Fixes the camera channel (The recorder will always output the audio of the selected camera.)

Default: Selected camera

Note:

- To output audio from the monitor, set [Audio] in the Advanced recording setup (☞ page 43) to a setting other than "Off".

■ Other setup

[Detect a power-off of the sub monitor (HDMI)]

If checked, when a sub-monitor is used in the configuration, the camera will notify you with an error behavior if the sub-monitor is not connected or powered off.

Note:

- Some monitors may not be detected even if the monitor's power switch is turned off.

[Display stream 2 live image when displaying on the monitor with 1-screen display.]

Mark the checkbox to display 1-screen live image on stream 2.

Note:

- The frame rate of the live image varies depending on the camera model and camera mode.

Configure the settings relating to network [Network]

The settings relating to the network of the recorder are configured on the setup menu - the "Advanced setup" menu - the "Network" page.

The "Network" page has [Basic], [e-Mail], [TCP alarm notification], [HTTP alarm] and [NTP/SNMP] tabs.

Configure the basic network settings [Basic]

The basic settings relating to the network can be configured on this tab.



Note:

- Enter the address octets and port numbers right-aligned. (Example: When the port number is 80, enter "00080".) The leading zeros are omitted here.

■ Network Setup

Configure the network settings of the recorder.

[IP address]

The IP address of the recorder will be displayed. To change the IP address, select each octet of the address, and click the [▲]/[▼] button.

Default: 192.168.0.250

[Subnet mask]

Select the subnet mask in accordance with the recorder's network environment. Enter in the same way as the IP address.

Default: 255.255.255.0

[Default gateway]

Select the address for the default gateway in accordance with the recorder's network environment. Enter in the same way as the IP address.

Default: 192.168.0.1

■ DNS Setup

The settings relating to DNS (Domain Name System) can be configured on this tab.

[DNS]

Determine whether or not to use the DNS.

Off : Does not use the DNS.

Manual: When using DNS, it is possible to search IP addresses by host name.

Default: Off

[Primary server address]

[Secondary server address]

When the DNS is used, select the IP addresses for the primary and secondary DNS server. Enter in the same way as the IP address.

Default: 0.0.0.0

[Domain name]

Enter the domain name of the recorder. The first character of the domain name should be an alphabetical character.

Enter 3 to 63 alphanumeric characters including hyphens (-) and periods (.).

Default: localdomain

■ DDNS Setup

Select the DDNS service to determine whether or not to use DDNS.

Off: Does not use the DDNS function.

Dynamic DNS update: Uses Dynamic DNS Update (RFC2136 compliant).

Default: Off

When using Dynamic DNS Update

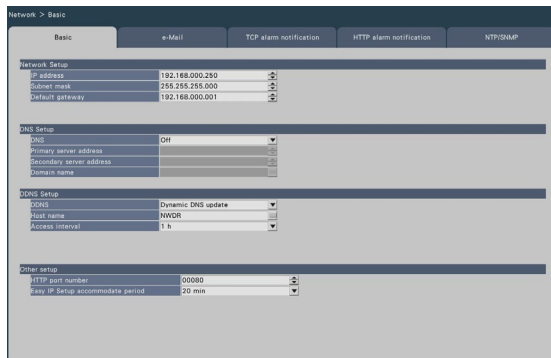

[Host name]

Enter the host name to use with the Dynamic DNS Update service.

Available number of characters : 0 to 250 characters
Enter in the format (Host name).(Domain name)

Default: NWDR

Note:

- Contact your network administrator regarding usable host names.

[Access interval]

From the below, select the interval for checking the IP address and host name of the Dynamic DNS Update Service server.

10 min. / 20 min. / 30 min. / 40 min. / 50 min. / 1 h / 6 h / 24 h.

Default: 1 h

Important:

- Port forwarding needs to be set on the router before using the DDNS service of another company. Absolutely no warranty is provided for behavior involving another company's DDNS service.
- Accordingly, our company bears no responsibility for any failure or damage caused in the using environment of this product due to the use of another company's DDNS service. For information regarding the selection and setting of DDNS services of other companies, contact the service provider.

■ Other setup

[HTTP port number]

Specify the HTTP port number to be used to send images from the recorder.

It is unnecessary to change it for normal use.

1 - 65535

Default: 80

Note:

- Depending on the network settings, network communication may not be established if the HTTP port number has been changed. In this case, refer to the administrator of each network.
- The following numbers, the HTTPS port number, the site alarm receive port number and the port number of the port forwarding are unavailable.
20, 21, 23, 25, 42, 53, 67, 68, 69, 79, 105, 110, 123, 161, 162, 443, 546, 547, 995, 10001, 10002, 10003, 10004, 10005, 10006, 10007, 50000~50255

[Easy IP Setup accommodate period]

Set time to enable operation of the network settings from the dedicated software to 20 minutes or unlimited from the launch of the recorder.

20 min: Enables operation to change the IP address of the recorder from the dedicated software for 20 minutes only after the launch of the recorder.

Unlimited: Always enables operation to change the IP address of the recorder from the dedicated software.

Default: 20 min

Configure the settings relating to the mail notification [e-Mail]

The settings of alarm mail notice, the settings of warning mail (☞ Page 185) and the settings to use the mail functions can be configured on this tab.



[SMTP server address]

Enter an IP address or a name of the SMTP server to send e-mails. The name of the SMTP server is available only when "Manual" is selected for "DNS" on the [Basic] tab accessed from the "Advanced setup" menu - the "Network" page of the setup menu. Enter up to 255 alphanumeric characters including hyphens (-) and periods (.).

[SMTP port number]

Enter the port number of the SMTP server.

1 - 65535

Default: 25

[POP server address]

Enter an IP address or name of the POP server to be used for POP before SMTP authentication. The name of the POP server is available only when "Manual" is selected for "DNS" on the [Basic] tab accessed from the "Advanced setup" menu - the "Network" page of the setup menu. Enter up to 255 alphanumeric characters including hyphens (-) and periods (.).

[Authentic method]

Select the authentication method to send e-mails from the following.

None/ POP before SMTP/ SMTP

Default: None

[Authentic method - User name]

Enter the user name to be required for the authentication. Enter up to 32 alphanumeric characters excluding " " , " & " listed in the description of "Note".

[Authentic method - Password]

Enter the password to be required together with the user name for the authentication. Enter up to 32 alphanumeric characters excluding " " , " & " listed in the description of "Note". An entered character for the password will be displayed as "*" .

Note:

- Available characters are as follows.

A B C D E F G H I J K L M N O P Q R S T U V W X
Y Z a b c d e f g h i j k l m n o p q r s t u v w x y z
0 1 2 3 4 5 6 7 8 9 ! # \$ % ' () * + , - . / : ; < = > ?
@ [¥] ^ _ ` { | } ~

[Sender's address]

Enter the mail address of a sender. Entered mail addresses will be displayed in the "From" (sender) line. Enter up to 127 alphanumeric characters including hyphens (-), periods (.), @, and _.

Default: NWDR

[Security]

Alarm mails or warning mails will be encrypted and transmitted. Authentication method will be set to "SMTP" if it is not set to "Off". Set the user name and password for the authentication.

Off / SMTP over SSL / STARTTLS

Default: Off

[Destination address - Address1 - Address4]

Enter the mail addresses of the recipients of the alarm mail and the warning mail (☞ Page 185). Enter up to 255 alphanumeric characters including hyphens (-), periods (.), @, and _.

Check the desired mail type (Warning/Alarm) to be sent.

Up to 4 destination addresses can be registered.

Configure the TCP alarm notification settings [TCP alarm notification]

The settings to notify the PC of the event and error information when an event or an error occurs can be configured on this tab.

To display the event and error information, it is necessary that the software (option) is installed on the recipient PC.

Refer to our technical information web site for details on the software.

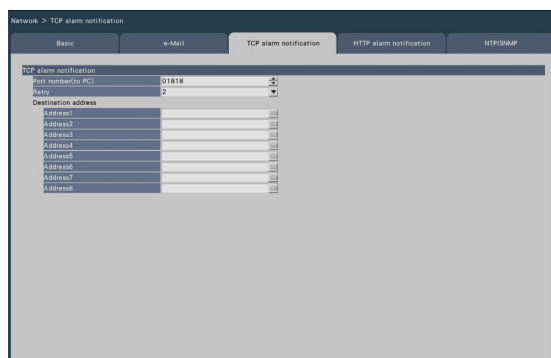

[Port number(to PC)]

Enter the port number of the recipient PCs.

It is usually not necessary change the default.

Default: 1818

[Retry]

Set the number of retry attempts for the transmission to the PC.

0 - 8 (times) (In steps of times)

Default: 2

Note:

- If the transmission to the PC fails, increase the number of retry attempts.
-

[Destination address - Address1 - Address8]

Enter the addresses of the recipient PCs. Enter the IP address or host name for "Address1" - "Address8".

The host name is available only when "Manual" is selected for "DNS" on the [Basic] tab accessed from the "Advanced setup" menu - the "Network" page of the setup menu.

Up to 8 destination addresses can be registered.

Enter up to 255 alphanumeric characters including hyphens (-) and periods (.).

Configure HTTP alarm notification settings [HTTP alarm]

Configure the settings to notify the PC via HTTP when an event or error occurs.

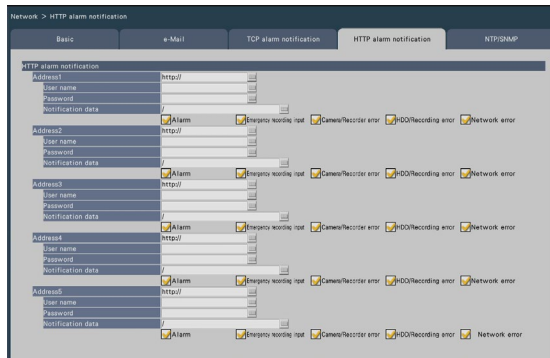

[Address 1] to [Address 5]

Set the IP address or host name of the HTTP server for HTTP alarm notification. Up to 5 addresses can be set.

Available number of characters: 0 - 255 characters

Available characters: Half-width alphanumeric characters, half-width symbols

Default setting: http://

Input example: http://IP address: Port number, or
http://host name: Port number

https://IP address: Port number, https:// host name:
Port number

[User name]

Enter the user name to access the HTTP server.

Available number of characters: 0 - 63 characters

Unavailable characters: Full-width and half-width symbols " " " " & "

Default setting: Blank

[Password]

Enter the password to access the HTTP server.

Available number of characters: 0 - 63 characters

Unavailable characters: Full-width and half-width symbols " " " " & "

Default setting: Blank

Note:

- Basic or Digest authentication is performed according to the HTTP server's authentication request.
-

[Notification data]

Enter the content of the notification to be added after the HTTP servers set in [Address 1] to [Address 5].

Available number of characters: 0 - 255 characters

Available characters: Half-width alphanumeric

characters, half-width symbols

Default setting: /

By checking the "Alarm", "Emergency recording input", "Camera/Recorder Error", "HDD/Recording Error" and "Network error" checkboxes, HTTP alarm notifications will be sent when the respective event or error occurs.

Note:

- If you enable the HTTP alarm function, the authentication information (user name and password) of the HTTP server may be leaked on the network when an alarm is notified to the HTTP server.
 - The "Notification data" must be entered with a slash (/).
 - If the "Notification data" is left blank and press the [OK] button, "/" will be set.
 - Example: If "http://192.168.0.100" is set as the "Address" and "/cgi-bin/comalarm.cgi?CMD=01" is set as the "Notification data", the HTTP alarm notification "http://192.168.0.100/cgi-bin/comalarm.cgi?CMD=01" will be used for the HTTP alarm notification.
-

Configure the settings relating to NTP/SNMP synchronization [NTP/SNMP]

The settings to synchronize the system clock with the NTP (Network Time Protocol) and SNMP (Simple Network Management Protocol) server can be configured on this tab.

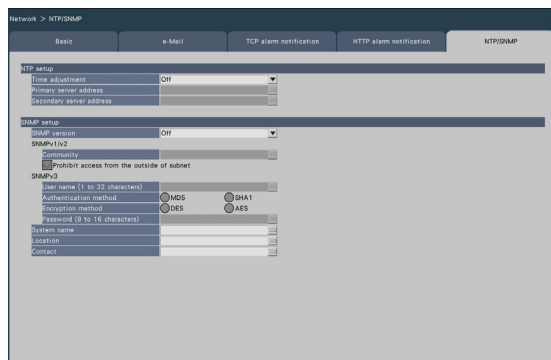

■ NTP setup

[Time adjustment]

Select "On" or "Off" to determine whether or not to adjust the time according to the NTP server.

On: Adjusts the time automatically.

Off: Does not adjust the time automatically.

Default: Off

Important:

- Inaccuracy of time stamp on recorded images due to inaccurate clock adjustment of this product may cause operational problems. When the system operation requires an accurate time setting, use the NTP auto time adjustment using an NTP server.

[Primary server address]

[Secondary server address]

Enter the address or name of the NTP server when adjusting the time using the NTP server.

The name of the NTP server is available only when "Manual" is selected for "DNS" on the [Basic] tab accessed from the "Advanced setup" menu - the "Network" page of the setup menu.

Enter up to 255 alphanumeric characters including hyphens (-) and periods (.).

Note:

- Entering "http://" is not necessary if the server name is entered.

Important:

- It is possible to run the recorder as an NTP server to be referred by the cameras. In this case, set the port number of the camera to "123". Refer to the operating instructions of the connected camera for information on how to configure the settings of the camera.

■ SNMP setup

Set this item to check the status of the recorder by connecting to the SNMP server.

[SNMP version]

Select the SNMP version to be used.

By using SNMPv3, communication data can be encrypted and communication security can be improved.

Off: SNMP is not used.

SNMPv1/v2: SNMPv1/v2 will be enabled.

SNMPv3: SNMPv3 will be enabled.

SNMPv1/v2/v3: SNMPv1/v2/v3 will be enabled.

Default: Off

[SNMPv1/v2 - Community]

Enter a name used for SNMP authentication (up to 32 alphanumeric characters).

Characters that cannot be input: half-width symbols " " "

[SNMPv1/v2 - Prohibit access from the outside of subnet]

Set whether to prohibit access from the outside of subnet by SNMPv1/v2.

Checked: Prohibits access from the outside of subnet.

Not checked: Allows access from the outside of subnet.

Default setting: Checked

Important:

- To ensure security, it is suggested to prohibit access from outside the subnet when SNMPv1/v2 is used.

[Setup via recorder's main monitor]

[SNMPv3 - User name]

The user name of SNMPv3 will be set.

Number of input characters: 1 to 32

Characters that cannot be input: half-width symbols

" " ", " & ", " : ", " ; ", " ¥ "

[SNMPv3 - Authentication method]

Select the authentication method of SNMPv3 from MD5/SHA1.

Default: MD5

[SNMPv3 - Encryption method]

Select the encryption method of SNMPv3 from DES/AES.

Default: DES

[SNMPv3 - Password]

Set the password of SNMPv3.

For the password, use three or more types of characters from upper- and lowercase alphabetic characters, numbers, and symbols. Set a password which does not include the user name.

Number of input characters:

- When the authentication method is MD5: 8 to 16 characters

- When the authentication method is SHA1: 8 to 20 characters

Characters that cannot be input: half-width symbols

" " ", " & "

[System name]

Enter a name (up to 255 alphanumeric characters) for management of the recorder by the SNMP system.

Characters that cannot be input: half-width symbols

" " "

Example: No1

[Location]

Enter a location where the recorder is installed. (up to 255 alphanumeric characters)

Characters that cannot be input: half-width symbols

" " "

Example: 2F

[Contact]

Enter the contact information such as a mail address of an administrator of this recorder.

(up to 255 alphanumeric characters)

Characters that cannot be input: half-width symbols

" " "

Configure the settings relating to the user management [User management]

The settings such as user authentication On/Off, administrator registration and operation levels can be configured on the setup menu - the "Advanced setup" menu - the "User management" page. The "User management" page has [Basic], [User registration], [Administrator setup] and [Host registration] tabs.

Configure the basic settings relating to user management [Basic]

The settings relating to login when using the mouse, user authentication for network operations, and user levels can be configured on this tab.

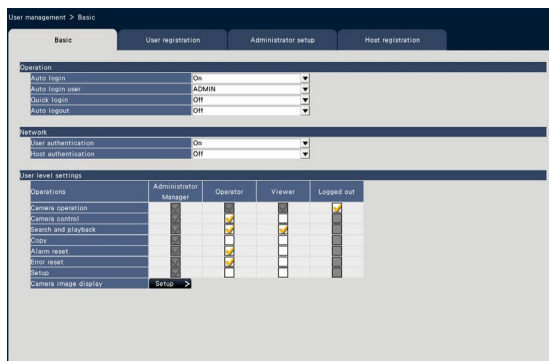

■ Operation

Configure the settings to enable auto login when turning on the recorder.

[Auto login]

Select "On" or "Off" to determine whether or not to activate the auto login function.

On: Logs in to the recorder automatically.

Off: Does not log in to the recorder automatically.

Login is required when operating the recorder from the logout status.

Default: On

[Auto login user]

When "On" is selected for "Auto login", the users registered as auto login users in this setting can log in to the recorder automatically. An auto login user should be one of the users registered in the recorder.

Default: (Administrator)

[Quick login]

Select "On" or "Off" to determine whether to enter or select the user name.

Off: User name needs to be entered.

On: Login by selecting a displayed user name.

Default: Off

[Auto logout]

Set the time to wait until auto logout when no operations are made while displaying live images.

Off: Does not logout to the recorder automatically.

After 1 min/ After 3 mins/ After 5 mins/

After 30 mins

Default: Off

Note:

- When "On" is selected for "Auto login", the user will not be logged out automatically even if other values than "Off" is selected for "Auto logout". When logout is performed (see Page 105), login will be automatically performed by the user registered in "Auto login user".
- To prevent inappropriate operations, it is recommended to select settings other than "Off" for "Auto logout".

■ Network

Determine whether or not to require user authentication for operating the recorder from a PC.

[User authentication]

Select "On" or "Off" to determine whether or not to authenticate the user.

On: Login followed by user authentication

Off: Login without user authentication

Default: On

[Host authentication]

Determine whether to enable or disable the host authentication.

On: Login followed by host authentication.

Off: Login without the host authentication.

Default: Off

■ User level settings

Set up the operations allowed at each user level (Administrator/Manager/Operator/Viewer) by marking the respective checkboxes. To stop a user from operating certain functions, do not check the respective function. The setting for the administrator cannot be changed. The system can also be set up to allow only live operation (image switching) after logout.

Note:

- Only a user logged in as "Administrator/Manager" can change the user level settings.
- At the default, operations allowed at the user level are as follows:
 - Administrator/Manager: Possible to perform all the operations (Administrators)
 - Operator: Possible to perform a part of the settings of the recorder and alarm reset (Head of operators)
 - Viewer: Possible to monitor or play the images (Operators)

* Administrators and managers can perform all operations. The difference between an administrator and a manager is that an administrator has priority over a manager; if both perform the same operation at the same time, that of the administrator will have priority.

- The screenshot shows the default.
- When a user tries to operate a function that is not checked (restricted function), the login window may sometimes be displayed to prompt a user with the required user level to log in.

Restrictable operations

It is possible to allow or restrict the following operations for each user.

Operation	Description
Camera operation	Camera images displayed on the main monitor can be changed.
Camera control	Camera control such as panning and tilting can be performed.
Search and playback	Recorded images can be played back and searched by VMD search.
Copy	Recorded images can be copied to storage media such as a USB.
Alarm reset	An alarm action can be canceled.
Error reset	An error action can be canceled.
Setup	Setup menus can be displayed and the settings can be configured.
Camera image display	Images from each camera can be displayed. To set up the display of camera images, click the [Setup >] button. (☞ page 65)

* It is recommended to restrict "Setup" to the manager/administrator.

* Even if "Setup" is set to be available to each user, there will be some operations restricted to the administrator only.

* If the user level is not displayed for the camera image, it is recommended that the "Copy" operation among same user level will not be allowed.

Set up the user level for individual cameras

Select the cameras allowed for operation by each user level (operator/viewer/logged out) by marking the respective checkboxes.

Remove the check mark from any cameras not to be displayed. The setting for the administrator/manager cannot be changed.

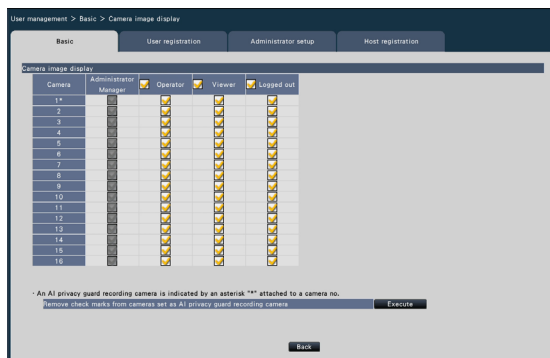

[Back] button

Click the button after completing the settings. The screen returns to the [Basic] tab.

Note:

- If the AI privacy guard recording camera is set, clicking the [Execute] button on the screen can remove all the check marks from the cameras without AI privacy guard.

Register, edit or delete the user information [User registration]

Use this tab to register, edit or delete user names and passwords.

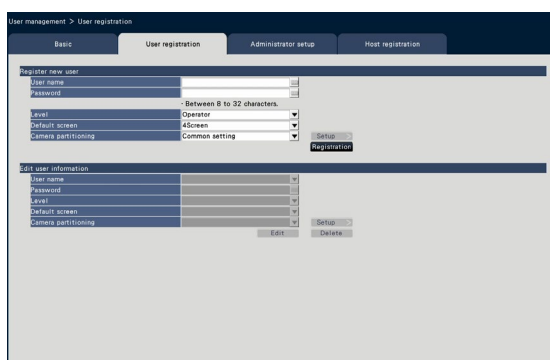

■ Register new user

Register user information such as a user name, password and operation level.

The maximum number of users that can be registered is 32.

[User name]

Enter the user name using the on-screen keyboard.

The user name must be between 1-32 characters including the half-width alphanumeric and the symbol excluding " ", "&", ":", ";", "¥", ".",

[Password]

Enter the user password using the on-screen keyboard. The password must be between 8-32 characters including the half-width alphanumeric and the symbol (excluding " ", "&"). Use at least three types of characters among alphabet (uppercase), alphabet(lowercase), numbers and symbols. The registered password will be displayed as "*****" regardless of what is entered.

Important:

- For enhanced security, change the password on a regular basis.
- Do not reuse passwords on other recorders or devices.
- If you forget the administrator name and the password, the recorder must be initialized (repair).

[Level]

Display the operation level of a user.

Operable functions can be set on the [Basic] tab (☞ Page 63).

Manager/ Operator/ Viewer

* Administrator and manager both have the same level, but the administrator has the higher priority.

Default: Operator

[Default screen]

Select a startup screen to be displayed after login.

Since the parameters differ depending on the model, refer to "Lists of the setting items" (☞ Page 81) for details.

(Refer to the "Operation window" section (☞ Page 102) for further information about each setting value.)

Default: 4Screen

Note:

- When any of wide view screen is selected, the default screen on the web browser of the PC will be set to the live image of camera 1.

[Camera partitioning]

Select which control range each camera should follow.

Common setting: The camera follows "User level settings" of "User management>Basic".

Individual setting: The camera follows camera partitioning settings set for each user.

Click the [Setup >] button to set the camera partitioning individually.

Set the camera partitioning individually.

Set availability of image display and camera operation in each camera for the assigned user.



View/Operate: Enables display of live/recorded images and camera operation.

View: Enables display of live/recorded images, but disables camera operation.

Off: Disables display of live/recorded images and camera operation.

Note:

- Camera operation is not available when "Camera control" is limited in "User level settings" of the [Basic] tab for the operation level of the assigned user, even if "View/Operate" is set.
- If the AI privacy guard recording camera is set, clicking the [Execute] button on the screen can turn Off all the settings for the cameras without AI privacy guard.

[Registration] button

Select this button to newly register the edited user information.

■ Edit user information

Edit or delete the user information that has been registered.

Select the user whose user information is to be edited or deleted. To edit items, proceed as for new user registration.

[Edit] button

Registers the edited user information.

[Delete] button

Deletes the selected user.

Edit the administrator information [Administrator setup]

The administrator information relating to the password and default screen, etc. can be registered on this tab.

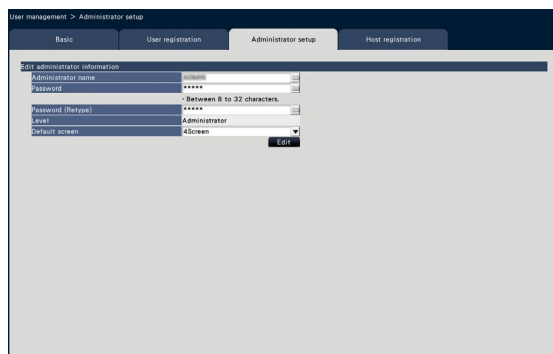

[Level]

Display the operation level of an administrator. It is impossible to change the setting value for an administrator. "Administrator" has been set for the administrator.

[Default screen]

Select a startup screen to be displayed after login. (Page 66)

[Edit] button

Register the edited administrator information.

[Administrator name]

Enter the administrator name using the on-screen keyboard. The administrator name must be between 1-32 characters including the half-width alphanumeric and the symbol excluding " ", "&", ":", ";", "¥", ",", ".", "

[Password]

Enter the administrator password using the on-screen keyboard. The password must be between 8-32 characters including the half-width alphanumeric and the symbol (excluding " " and " & "). Use at least three types of characters among alphabet (uppercase), alphabet (lowercase), numbers and symbols.

The registered password will be displayed as "*****" regardless of what is entered.

Important:

- For enhanced security, change the password on a regular basis.
 - Do not reuse passwords on other recorders or devices.
-

[Password (Retype)]

Enter the password that has been set for "Password" again for confirmation.

Register, edit or delete host [Host registration]

Register, edit or delete the host information of the PC which can access to the recorder via the Internet.

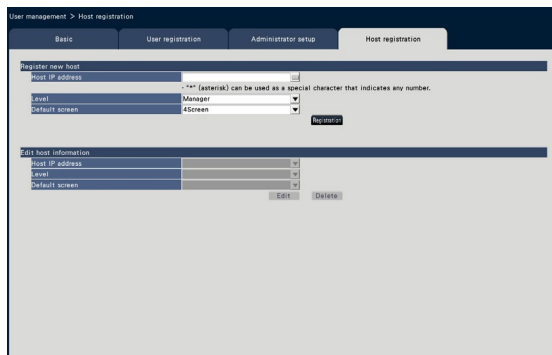

■ Edit host information

Change or delete the registered host information. Select a host information to change or delete on [Host IP address]. To edit items, proceed as for new user registration.

[Edit] button

Registers the edited user information.

[Delete] button

Deletes the selected user.

■ Register new host

Register the host information that uses the recorder such as the host IP address and the operation level. Up to 32 hosts can be registered.

[Host IP address]

Enter the IP address in IPv4 format.

- Enter the IP address in half width digits from 0 to 255.
- "*" can be used as a special character representing all numbers.
- "*. *.* ." cannot be registered.

[Level]

Select an operation level.

(Refer to the "User registration (Page 65)" for the setting contents).

Default: Manager

[Default screen]

Select a startup screen to be displayed after login on the web browser.

Since the parameters differ depending on the model, refer to "Lists of the setting items" (Page 93) for details.

Default: Cam.1

[Registration] button

Registers the set host information as a new.

Configure the settings relating to maintenance [Maintenance]

The version of the recorder and disk information is displayed, and the settings relating to hard disk drives can be configured on the setup menu - the "Advanced setup" menu - the "Maintenance" page. It is also possible to initialize the setup data of the setup pages, check the system logs and register the license on this page. The "Maintenance" page has [System information], [HDD information] and [System management] tabs.

Check the system information such as the version [System information]

The version (of the software and hardware), serial number, network information (MAC address, IP address, line speed, Communication speed), PoE total power supply, temperature inside the recorder and highest temperature inside the recorder, etc. are displayed on this tab.

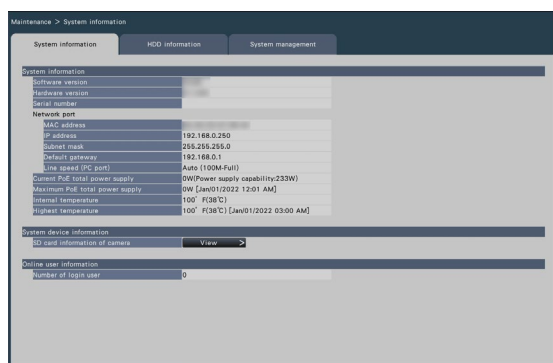

■ SD card information of camera

The SD card information and the SD memory backup progress of the camera in which the SD memory backup is set are displayed. Click [View >] button to display the following screen.

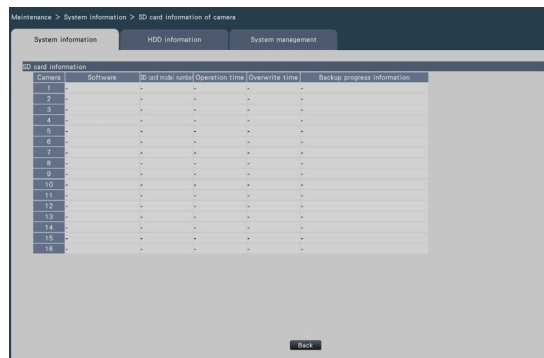

Note:

- System information will not be updated while the "Maintenance" page is being displayed.
- The current temperature in the body is higher than the ambient temperature due to a temperature increase of internal parts.
- The temperature increase of internal parts varies according to the load on equipment.
- The thermal error makes an error action to prevent failure or unsafety of equipment when temperature of internal parts (such as HDD and CPU) exceeds the specified temperature.
- The number of login users indicates those who have logged into the recorder via network.

[Software] Displays the software version of the camera.

[SD card model number] Displays the model number of the SD memory card used for the camera.

[Operation time] Displays the operation time of the SD memory card used for the camera.

[Overwrite time] Displays the number of the overwriting of the SD memory card used for the camera.

[Backup progress information] Displays the progress of the SD memory backup.

Date & time display: Date and time of the image being acquired from the SD memory card of the camera.

- : No image data to be acquired from the SD memory card of the camera is available.

Note:

- Some cameras may not be able to retrieve SD card information.

Confirm the hard disk drive information [HDD information]

Capacity of the hard disk drive and the running time of this product, time range of the recorded images, etc. will be displayed.

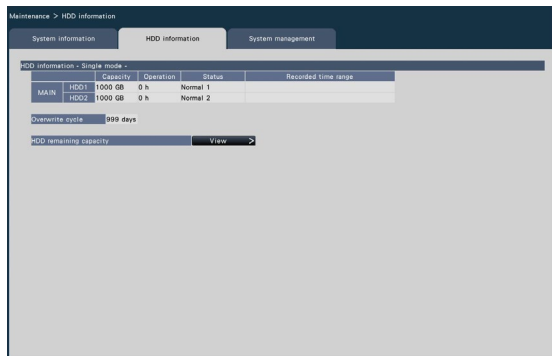

Note:

- HDD information will not be updated while the "Maintenance" page is being displayed.
- The recovery progress information is displayed next to the HDD operation mode display during mirroring recovery.
- If this product is under heavy load, images may not be recorded for several seconds at layback during mirroring recovery.

[Operation mode of HDD]

Operation mode of HDD will be displayed. Refer to "About the HDD operational mode" (page 79) for further information.

[Capacity]

Displays the capacities of the hard disk drives.

[Operation]

Displays the operating time of the hard disk drives.

[Status]

Displays the statuses of the hard disk drives.

- Normal: Hard disk drives that are operating normally. The number indicates the order of use.
- Playback-only: Hard disk drives for playback use only (Recording is unavailable.)
- Removed: Hard disk drives that are excluded from operation due to fault
- Error: Hard disk drives that have become faulty during the format process
- Blank: No HDD connected
- Added: HDD cannot be used until it is formatted

[Recorded time range]

Displays the time range of the images recorded on the hard disk drives.

Note:

- Although the range of date and time are displayed for the recovery target HDD even during mirroring recovery, the content will not be the same as the recovery source HDD until the recovery is completed.

[Overwrite cycle]

Calculates and indicates the overwriting cycle of the hard disk drives, based on the past recording performance (the date & time of the oldest recorded data, the current date & time and the capacity of the hard disk drive).

Note:

- While overwriting recording is being performed, the overwriting cycle will be calculated based on the date & time of the oldest recorded data and that of the newest recorded data.
- The more often the recording was performed in the past, the more accurate the calculation of overwriting cycle will be.
- When the recording conditions are changed or when data is automatically deleted, the overwriting cycle will not be indicated accurately.

[HDD remaining capacity]

Displays remaining capacity of HDD. Also, the timing to notice when the capacity becomes low can be set. Click [View] button to display HDD remaining capacity.

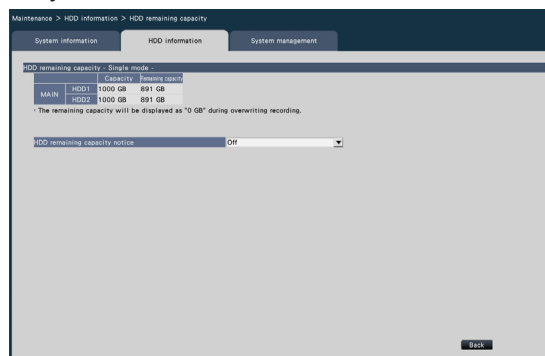

Example above shows the screen for single mode.

[Capacity]

Displays the capacity of HDD.

[Remaining capacity]

Displays remaining capacity of HDD.

Note:

- Remaining capacity displayed does not include capacity used to manage data. Therefore, the displayed HDD capacity is less than the actual amount.
 - Remaining capacity will displayed as 0GB if the whole space of the HDD is used up by recording data.
-

[HDD Remaining capacity notice]

Set the notification timing for when the remaining capacity of HDD becomes low compared to the total capacity. There are E-mail notification and original notification.

Off: Does not perform HDD remaining capacity notice.

1%~10%: Notifies when remaining capacity becomes below the set value.

Default: Off

Configure the settings and operations relating to the system [System management]

The settings relating to the actions at an error occurrence and auto data deletion from hard disk drives can be configured on this tab. It is also possible to display the logs on this page. In addition, general maintenance, such as license registration, setting initialization and firmware upgrade, can be performed on this tab.

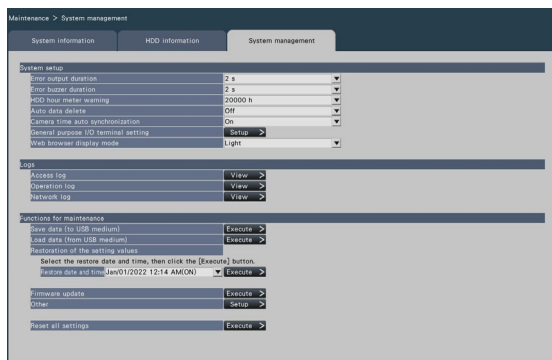

■ System setup

[Error output duration]

Select the duration to output a signal to notify the external devices of an error (HDD error, camera error, recorder error, recording error or network error). When "0 s" is selected, the signal is not output.

0 s/ 2 s/ 5 s/ 10 s/ 20 s/ 30 s/ 1 min

Ext.: When "Ext." is selected, the signal will keep on being output until the error is reset.

Default: 2 s

Note:

- Refer to the "Cancel the error action" section (☞ Page 125) for how to reset the error.

[Error buzzer duration]

Configure the settings to sound a buzzer at an error occurrence. When "0 s" is selected, buzzer will not sound.

0 s/ 2 s/ 5 s/ 10 s/ 20 s/ 30 s/ 1 min

Ext.: When "Ext." is selected, the buzzer that started sounding at an error occurrence will keep on sounding until the buzzer is stopped.

Default: 2 s

Note:

- Refer to the "Stop buzzer beeping" (☞ Page 124) for further information about how to stop buzzer beeping.

[HDD hour meter warning]

If the operation time of a hard disk drive reaches a specified level, a warning will be performed. When "Off" is selected, warning will not be performed.

Off/ 10000 h/ 20000 h/ 30000 h/ 40000 h/ 50000 h

Default: 20000 h

[Auto data delete]

Select to determine how many days should have passed from the recorded day to delete data automatically from the hard disk drive.

Off/ 1 day/ 2 days/ 3 days/ 4 days/ 5 days/ 6 days/ 7 days/ 8 days/ 9 days/ 10 days/ 14 days/ 30 days/ 45 days/ 60 days/ 90 days/ 120 days/ 150 days/ 180 days/ 184 days/ 365 days/ 366 days/ 730 days/ 731 days

Default: Off (Does not delete the data automatically.)

[Camera time auto synchronization]

When a date changes, the clock of the cameras will be synchronized with the clock of this product.

On: Synchronized

Off: Not synchronized

Default: On

[General purpose I/O terminal setting]

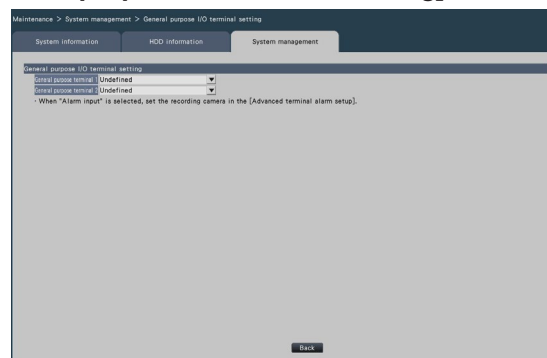

[General purpose 1] [General purpose 2]

Sets the application of the General purpose input/output terminals.

If the General purpose I/O terminals are not used, set to "Undefined".

Undefined/Alarm input/Alarm reset input/Network error output/Recorder error output

Default setting: Undefined

Note:

- Alarm reset input, network error output, and recorder error output can be set to either one of the General purpose I/O terminals.

[Web browser display mode]

Sets the background color of the web browser.

Light/Dark

Default setting: Light

■ Logs

The following logs can be checked.

- Access log: Logs of accessing the recorder
- Operation log: Logs of operating the recorder
- Network log: Logs of network errors

To check each log, click the [View >] button.

No.	Date & Time	Log
1	23/03/2021 15:04:19	ADMIN LOGOUT
2	23/03/2021 15:04:19	ADMIN LOGIN
3	23/03/2021 15:03:22	ADMIN LOGOUT
4	23/03/2021 15:03:21	ADMIN LOGIN
5	23/03/2021 15:01:18	ADMIN LOGOUT
6	23/03/2021 15:01:18	ADMIN LOGIN
7	23/03/2021 15:00:39	ADMIN LOGOUT
8	23/03/2021 15:00:20	ADMIN LOGIN
9	23/03/2021 15:00:20	ADMIN LOGOUT
10	23/03/2021 14:59:09	ADMIN LOGIN
11	23/03/2021 14:58:04	ADMIN LOGOUT
12	23/03/2021 14:58:04	ADMIN LOGIN
13	23/03/2021 14:57:52	ADMIN LOGOUT
14	23/03/2021 14:57:25	ADMIN LOGIN
15	23/03/2021 14:57:22	ADMIN LOGOUT
16	23/03/2021 14:57:22	ADMIN LOGIN
17	23/03/2021 14:55:44	ADMIN LOGOUT
18	23/03/2021 14:55:43	ADMIN LOGIN
19	23/03/2021 14:53:02	ADMIN LOGOUT
20	23/03/2021 14:53:01	ADMIN LOGIN

About the access log

The date & time when logged in/out for the recorder, the user name, and the IP address will be displayed.

Up to 500 logs are saved.

When more than 500 logs are filed, the older logs will be overwritten by the newer logs. In this case, the oldest log is the first to be overwritten.

LOGIN/LOGOUT: A user has logged in/out the recorder.

** indicates a user name or an IP address.

About the operation log

The operation log displays specific operations of the recorder and their dates and time in a list.

Up to 500 logs are saved.

When more than 500 logs are filed, the older logs will be overwritten by the newer logs.

CONFIG LOGIN / CONFIG LOGOUT: A host has logged in/out the "HDD management" page.

UPDATE SETTINGS: Settings have been changed.

POWER ON: The power of the recorder has been turned on.

POWER ON(UPDATE): The recorder is rebooted after the software is updated.

BEFORE TIME CHANGE MANUALLY: Before the system clock has been changed

AFTER TIME CHANGE MANUALLY: Just after the system clock has been changed

BEFORE TIME CHANGE BY NTP: Before the system clock has been changed by NTP

AFTER TIME CHANGE BY NTP: Just after the system clock has been changed by NTP

HDD FORMAT: The HDD has been formatted.

RESET ALL SETTINGS: The settings have been reset.

POWER ON (MAINTENANCE): The recorder has been rebooted by the operation of the setting menu.

RESET HIGHEST TEMPERATURE: The highest temperature information has been cleared.

RESET HIGHEST POE POWER: When the maximum PoE total power supply is achieved

POWER OFF: When the power to this product is turned Off.

Note:

- If power is turned off during startup, POWER OFF will not remain.

About the network log

The network error logs (occurrence date & time and error details) will be displayed in list form.

Up to 100 logs are saved. When more than 100 logs are filed, the older logs will be overwritten by the newer logs. In this case, the oldest log is the first to be overwritten. Refer to page 97 for further information about the error logs.

Note:

- Information will not be updated while logs are being displayed.

■ Functions for maintenance

License is added to operate the recorder. In addition, settings and operations are also performed for maintenance of the recorder.

[Save data (to USB medium)]

Saves the setting data on the USB medium. Click the [Execute >] button to display the confirmation window to start saving.

[Load data (from USB medium)]

Loads the setting data saved on a USB medium (external storage device) into the recorder. Click the [Execute >] button to display confirmation window to start loading.

Important:

- Click the [Set] button to save the settings and leave the menu after loading data.
-

[Restoration of the setting values]

Restores past settings stored in the device. Saves settings for the most recent startup and for the past 3 days. "(ON)" is added to the restoration date and time display at startup.

The setting values for the past three days are stored as of 2:10 a.m. every day. If the setting has not been changed from the most recent setting at that time, it will not be saved.

Select the date and time of the settings you wish to restore, then click the [Execute >] button to do so from the confirmation screen that appears.

Important:

- After restoring the settings, be sure to click the [Set] button and exit the menu.
-

[Firmware update]

Loads the software saved on a USB medium (external storage device) into the recorder to upgrade the firmware. Click the [Execute >] button to display the confirmation window to start initializing. Only an administrator can execute the firmware update.

Note:

- Do not turn off the power of the device during the update.
 - Usage time varies depending on the capacity of the USB medium or the recording content. Retry again later if you fail in operation.
 - Do not operate the recorder with multiple USB medium connected.
 - Use the USB medium formatted in exFAT, FAT (FAT 16) or FAT 32.
 - USB medium recognized by this recorder can be formatted by the recorder. Refer to page 145 for the format procedures.
 - USB medium with password authentication or requiring a dedicated driver or with the encryption function are not available.
 - Contact your dealer for further information about the firmware update.
-

[Other]

The special [Functions for maintenance] screen appears. (☞ Page 75)

[Reset all settings]

Initializes the setting data. Click the [Execute >] button to display the confirmation window for starting initialization.

Note:

- The following setting items will not be reset to the default or loaded or restored.
 - HTTP port number
 - Network Setup
 - DNS Setup
 - Security between this product and PC
-

Execute functions for special maintenance and service [Other]

Adjusts the date and time on the camera side to the monitoring system or reboots the monitoring system.

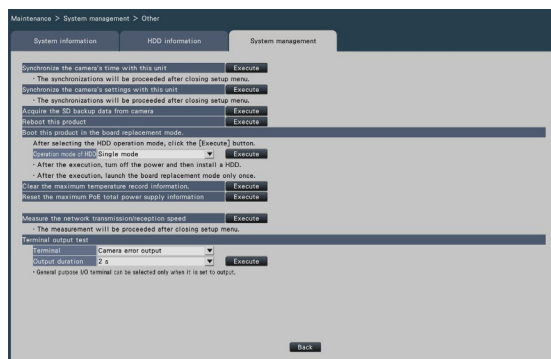

[Synchronize the camera's time with this unit]

Time and date of all the registered cameras will be synchronized with the clock of this product. The time and date synchronization will be executed when the setting is completed after executing on the confirmation window displayed by clicking the [Execute] button.

[Synchronize the camera's settings with this unit]

Reconfigure the settings of all the registered cameras based on the setting information of this product. The time and date synchronization will be executed when the setting is completed after executing on the confirmation window displayed by clicking the [Execute] button.

Important:

- Since this setting will change the settings of all cameras, please take an extra caution in case that the settings of each camera are customized individually.

[Acquire the SD backup data from camera]

Starts to acquire the image (SD memory data) recorded on the SD memory card of the camera in which the SD memory backup is set.

[Reboot this product]

Reboots the recorder.

[Boot this product in the board replacement mode.]

Used to replace the board.

Note:

- The board replacement mode is used during maintenance. Do not use it in ordinary operation.
- Contact your dealer for the board replacement.

[Clear the maximum temperature record information.]

Clears the highest temperature record information.

[Reset the maximum PoE total power supply information]

Reset the maximum PoE total power supply information of this product.

[Measure the network transmission/reception speed]

Used to measure the amount of network traffic transmitted from the recorder. Click the [Execute] button and execute from the confirmation window displayed. After configuration is completed, measuring starts.

The result of measurement will be displayed after measurement finishes.



Note:

- Measurement is made from about 8 seconds after setting is done and will continue measuring for 10 seconds.
- Status display area of operation screen will display " Measuring" while measuring.
- The result of measurement is the sum of all network ports.
- The result of measurement is only for reference. It may differ depending on the network environment.

[Terminal output test]

Outputs a signal from ALARM/CONTROL connector on the rear panel of the recorder.

Terminal: Selects the terminal at which to output the signal.

Test output duration: Select the duration over which the signal is output as 2 seconds, 5 seconds, or 10 seconds.

The signal will be output from the selected terminal when executed from the confirmation screen that is displayed by clicking [Execute] button.

Manage the hard disk drives [HDD management]

The operations relating to the hard disk drives such as checking the capacity of each recording area and formatting the drives can be performed on the "HDD management" page of the setup menu - the "Advanced setup" menu.

Important:

- All other operations such as recording and playback will stop when the "HDD management" page is displayed.
- Displaying the "HDD management" page forcibly logs out any other users currently logged in to the recorder.

How to display the "HDD management" page

Step 1

Click the [HDD management] button of the setup menu - the "Advanced setup" menu.

→ The window with the administrator name and password entry fields will be displayed. The window is also displayed when a user has already logged in as the administrator.

Step 2

Click the [OK] button after entering "Administrator name" and "Password" of an administrator.

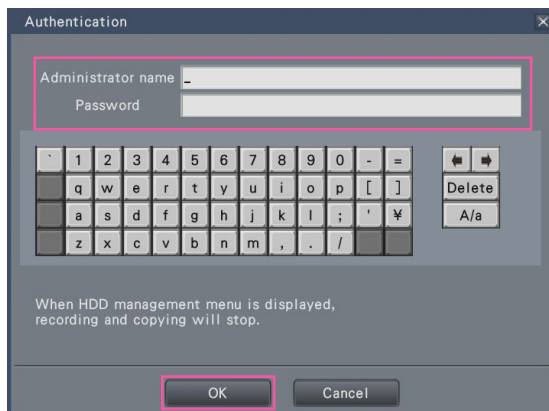

→ The "HDD management" page will be displayed.

Click the [Operation] button to return from the "HDD management" page to the operation screen.



Check the hard disk drive information [General]

The capacities, operation time and statuses of the hard disk drives are displayed.



Refer to the setup menu - the "Advanced setup" menu - the "Maintenance" page - the [HDD information] tab for further information about the items displayed on the [HDD information] tab. (Page 70)

Format the hard disk drives [Format HDD]

It is necessary to initialize the HDD by following format operation after installing the new HDD or replacing the HDD.

Important:

- When a hard disk drive is formatted, all the recorded images will be erased.

Step 1

Click the [Execute >] button for "Format HDD" on the [General] tab - [HDD management] page.

→ The window to format hard disk drives will be displayed.

Step 2

Check the hard disk drives to format in the "Format" field, and click the [Start] button. To start formatting, click the [OK] button on the confirmation window displayed.

When "OK" is displayed on the "Results" field, click the [Back] button.

When "Error" is displayed, format the hard disk drives again.

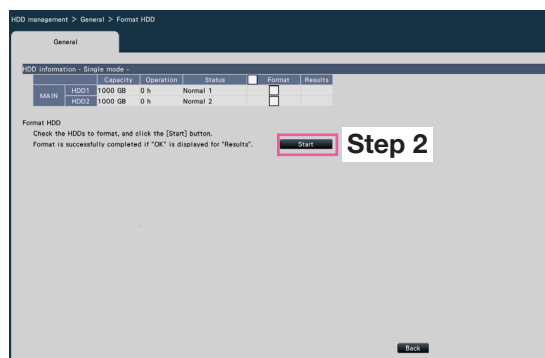

About the removal process and the link process of hard disk drives

When replacing the HDD, you need to remove the HDD before replacing it.

When the status of the replaced HDD is "Playback-only", in addition to the formatting of the HDD, it can be made into a recordable HDD by embedded processing.

Be sure to consult the dealer for the removal, installation, and the related process of hard disk drives.

Remove the HDD [Remove HDD]

Step 1

Click [Execute >] on the [Remove HDD].

→ The HDD removing screen will be displayed.



Step 2

Check the HDD to be removed in the Remove column and click the [Start] button.

The HDDs can be removed when "OK" is displayed in the "Results" field. Click the [Back] button.

Add the HDD [Add HDD]

Step 1

Click [Execute >] on the [Add HDD].

→ The HDD adding screen will be displayed.



Step 2

Check the HDDs to add, and click the [Start] button.

The process is completed when "OK" is displayed in the "Results" field and the HDDs are ready for recording. Click the [Back] button.

Important:

- When the link process is performed, the data will be erased.

About the change of the HDD operational mode

About the HDD operational mode

- Single mode: Images and audio from the cameras will be recorded on the HDD of this product.
- Mirroring mode: The same images and audio from the cameras will be recorded on the 2 HDDs of this product.
- When one of the 2 HDDs is replaced with a new one, it is possible to copy data on the other HDD to the replaced HDD.

Change the operation mode of HDD [Change the operation mode of HDD]

Step 1

Click the [Execute >] button on the "Change the operation mode of HDD" section.

→ The "Change the operation mode of HDD" window will be displayed.

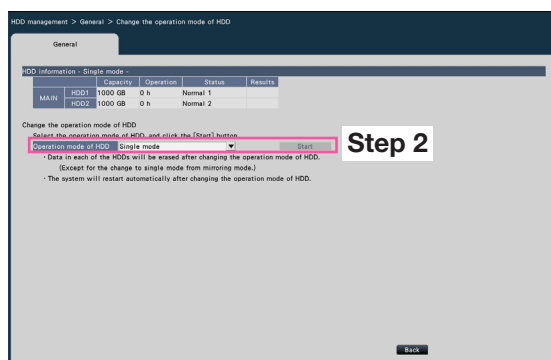

Step 2

Select the desired operation mode of HDD, and then click the [Start] button.

Important:

- When the operational mode of HDD is changed (except the case that the operational mode is changed from the mirroring mode to the single mode), all data on the HDDs will be erased.
- The capacity of the HDD in the mirroring mode will become almost half if compared with the single mode.
- When the operational mode of HDD is changed from the mirroring mode to the single mode, the status of the HDD will turn to "Playback-only".
- When "Operation mode of HDD" is changed, the recorder will be automatically rebooted.

Note:

- Only NU301 can use the mirroring mode.
- When one of the HDDs is replaced in the mirroring mode, "Add" will be displayed in the status information section of "HDD information". The newly replaced HDD will start working in the mirroring mode when "Add HDD" is executed. In this case, all data on the replaced HDD will be erased.

Configure the security settings [Security]

Set the security settings on the security function page of [Advanced setup] on the setup menu.

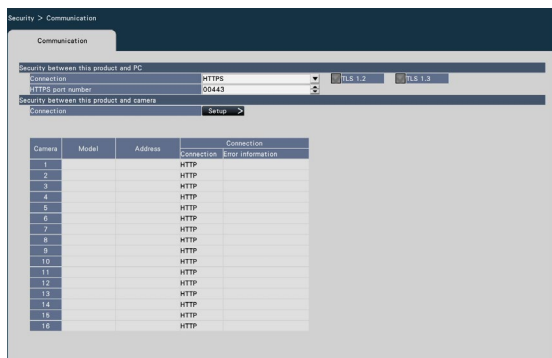

■ Security between this product and PC

Connect the recorder and the PC with the HTTPS. The HTTPS encodes the access to the recorder and enhances the safety of the communication.

[Connection]

Set the connection.

HTTP & HTTPS: The HTTP and HTTPS connections are available.

HTTPS: The HTTPS connection is only available.

Default: HTTPS

[HTTPS port number]

Set the port number used for the HTTPS.

1 - 65535

Default: 443

Note:

- The following numbers, the HTTP port number, the site alarm receive port number and the port number of the port forwarding are unavailable. 20, 21, 23, 25, 42, 53, 67, 68, 69, 79, 80, 105, 110, 123, 161, 162, 546, 547, 995, 10001, 10002, 10003, 10004, 10005, 10006, 10007, 50000~50255

■ Security between this product and camera

HTTPS is used to connect between this product and the camera. By using HTTPS, communication with the camera can be encrypted and secure.

Note:

- If the server certificate has expired, "-(expired)" will be displayed in the error information.
- When the connection method with the camera is set to "Internet mode", the image data communication is also encrypted, thus further increasing the security of the connection.
- Cameras whose part number is "RTSP" or "RTSP(FE)" may not be able to connect via HTTPS, depending on the camera used.

[Connection]

Set the connection method between this product and the camera. Clicking the [Settings>] button will open the "Change connection" window, where you can change the settings. After changing the settings, click the "OK" button to save the settings and return to the [Security] tab.

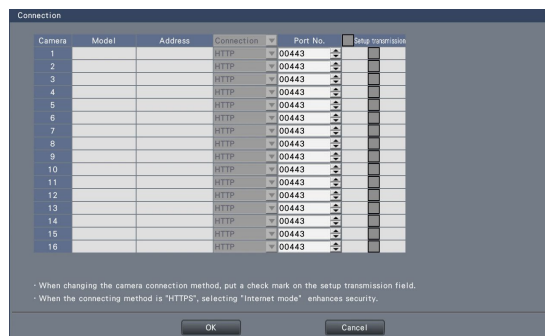

[Connection]

Set the connection method between this product and the camera.

HTTP: Connect via HTTP.

HTTPS: Connect via HTTPS.

Default: HTTP

[Port number]

HTTPS port number used by this product for SSL communication with the camera set.

1 - 65535

Default: 443

[Setup transmission]

Select the camera to which you want to send the settings. Confirm the cameras to which you want to send the configured connection method.

Lists of the setting items (Setup menu)

Quick setup (Easy Start)

Setting item (including those of the "Advanced setup" menu)		Available range	Default
Date & time adjustment		2022/1/1 0:00 ~ 2046/12/31 23:59	20nn/mm/1 0:00 ("nn" and "mm" are calculated base on the serial number of the recorder.)
Set time zone		GMT-12:00, GMT-11:00, GMT-10:00, GMT-9:00, GMT-8:00, GMT-7:00, GMT-6:00, GMT-5:00, GMT-4:30, GMT-4:00, GMT-3:30, GMT-3:00, GMT-2:00, GMT-1:00, GMT, GMT+1:00, GMT+2:00, GMT+3:00, GMT+3:30, GMT+4:00, GMT+4:30, GMT+5:00, GMT+5:30, GMT+5:45, GMT+6:00, GMT+6:30, GMT+7:00, GMT+8:00, GMT+9:00, GMT+9:30, GMT+10:00, GMT+11:00, GMT+12:00, GMT+13:00	GMT
Activate the Daylight saving time		Checked/Not checked	Checked
Camera registration	User Name	(Enter text)	(Blank)
	Password	(Enter text)	(Blank)
	Confirm password	(Enter text)	(Blank)
Recording setup (The same setting for all cameras)	Frame rate	1 ips, 3 ips, 5 ips, 10 ips, 15 ips, 30 ips	10 ips
	Image quality	NQ, FQ, SF, XF	FQ
	Smart coding (GOP control)	Off, On(Advanced)	Off
	Audio	Off, On(AAC-LC)	Off
	Referenced recording days	(Calculated result will be displayed.)	(Calculated result will be displayed.)

Basic setup

(Remarks: "●" are the setting items configured on "Easy Start". "◎" are the setting items configured from the web browser. "★" are the setting items only configurable with web browser.)

Menu/Tab	Setting item (including those of the "Advanced setup" menu)		Available range	Default	Remarks
Date/Language					
Date & time adjustment	Date & Time		2022/1/1 0:00 ~ 2046/12/31 23:59	20nn/mm/1 0:00 ("nn" and "mm" are calculated base on the serial number of the recorder.)	● ◎
Date & time settings	Display format	Date	yyyy/mm/dd, Mmm/dd/yyyy, dd/Mmm/yyyy, mm/dd/yyyy, dd/mm/yyyy	dd/mm/yyyy	◎
		Time	24 h, 12 h	24 h	◎
	Time zone	Set time zone	Refer to "Set time zone" of "Quick setup (Easy Start)".	Refer to "Set time zone" of "Quick setup (Easy Start)".	◎
		Daylight saving time	Out, Auto	Auto	◎
		Start/End date and time	Designate by day of the week, Designate by date	Designate by day of the week	◎
		Start/End date and time (Designate by day of the week) In/Out	00:00 Monday, 1st week of January ~ 23:59 the last Sunday of December	In: The last Sunday in March, 1:00 this year and subsequent years. Out: The last Sunday in October, 1:00 this year and subsequent years.	◎

Menu/Tab	Setting item (including those of the "Advanced setup" menu)		Available range	Default	Remarks
Date & time settings	Time zone	Start/End date and time (Designate by date) In/Out	1/1 00:00 ~ 12/31 23:59	In: --/-- --:-- Out: --/-- --:--	⊙
Language	Language		Japanese/ English/ Français/ Español/ Deutsch/ Italiano/ Português/ ไทย/ Tiếng Việt/ 简体中文/ 繁體中文 (Web browser: Japanese/ English/ Français/ Español/ Deutsch/ Italiano/ Português/ Thai/ Vietnamese/ Simplified Chinese/ Traditional Chinese)	English (Web browser: English)	⊙

Camera

Camera registration	Model		(Indication only)	(Indication only)	⊙
	Address		(Indication only)	(Indication only)	⊙
	Compression		(Indication only)	(Indication only)	⊙
	Error information		(Indication only)	(Indication only)	⊙
	Registered information	Model/Option	Corresponding camera number/Option	(Blank)	⊙
		Address	(Address)	(Blank)	⊙
		Compression	H.265(1), H.265(3), H.265(4), H.264(1), H.264(3), H.264(4), MJPEG	(Blank)	⊙
		Authentication	Digest, Digest or Basic	Digest	⊙
		User name	(Text will be entered.)	(Blank)	⊙
		Password	(Text will be entered.)	(Blank)	⊙
	Port No.	(Port No.)	80	⊙	
AI privacy guard recording camera	Recording camera	Blank, Cam.1, ..., Cam.n	(Blank)	⊙	
Camera setup	Date & time display	Display (check box)	Checked/Not checked		
		Display (drop-down list)	Off, On		
		Position (check box)	Checked/Not checked		
		Position (drop-down list)	L-Upper, L-Lower, R-Upper, R-Lower		
		Camera selection	Checked/Not checked		
	Display title	Display (check box)	Checked/Not checked		
		Display (drop-down list)	Off, On		
		Display Title (check box)	Checked/Not checked		
		Display Title	(Text will be entered.)		
		Camera selection	Checked/Not checked		
	Indicator	Indicator	On, On (Access), Off		
		Camera selection	Checked/Not checked		
	Transmission priority	Setting items (Transmission priority)	Frame rate, Advanced VBR, VBR		
		Stream1	Checked/Not checked		
		Stream2	Checked/Not checked		
		Setting items (Priority setting)	Checked/Not checked		

Menu/Tab	Setting item (including those of the "Advanced setup" menu)	Available range	Default	Remarks
Camera setup	Transmission priority	Priority setting	Image quality priority, Frame rate priority	
		Setting items (Burst tolerance level)	Checked/Not checked	
		Burst tolerance level	High, Middle, Low	
		Setting items (Control time period)	Checked/Not checked	
		Control time period	1 h, 6 h, 24 h, 1 week	
		Setting items (Smart coding (GOP control))	Checked/Not checked	
		Smart coding (GOP control)	Off, On (Advanced)	
		Camera selection	Checked/Not checked	
	Refresh interval	Refresh interval	0.2 s, 0.5 s, 1 s, 2 s, 3 s	
		Camera selection	Checked/Not checked	
	Upside-down	Upside-down	On (desktop), Off (ceiling), Wall	
		Camera selection	Checked/Not checked	
	Image rotation	Image rotation	0 °(Off), 90 °, 180 °(Upside-down), 270 °	
		Camera selection	Checked/Not checked	
	Pan/tilt-flip	Pan/tilt-flip	Off, On	
		Camera selection	Checked/Not checked	
	Self return	Self return	Off, Home position, Auto track, Auto pan, Preset sequence, Patrol	
		Self return time	10 s, 20 s, 30 s, 1 min, 2 min, 3 min, 5 min, 10 min, 20 min, 30 min, 60 min	
		Camera selection	Checked/Not checked	
	Super Dynamic (Wide dynamic range)	Super Dynamic (Wide dynamic range)	Off, On, On (High)	
		Camera selection	Checked/Not checked	
	Adaptive black stretch	Adaptive black stretch	Off, On, Reset, 0, 16, 32, 48, 64, 80, 96, 128, 144, 160, 176, 192, 208, 224, 240, 255	
		Camera selection	Checked/Not checked	
	Back light compensation (BLC)	Back light compensation (BLC)	Off, On	
		Camera selection	Checked/Not checked	
	Light control mode	Light control mode	Outdoor scene, Indoor scene (50Hz), Indoor scene (60Hz), ELC	
		Camera selection	Checked/Not checked	
	Auto slow shutter (Maximum shutter)	Auto slow shutter (Maximum shutter)	Off (1/30 s), Max. 2/30s, Max. 4/30s, Max. 6/30s, Max. 10/30s, Max. 16/30s	
		Camera selection	Checked/Not checked	
	Day & Night (IR/electrical)	Day & Night (IR/electrical)	Off, On, On (IR Light On), Auto1 (Normal)/Auto, Auto2 (IR Light), Auto3 (SCC)	
		Camera selection	Checked/Not checked	

Menu/Tab	Setting item (including those of the "Advanced setup" menu)		Available range	Default	Remarks	
Camera setup	Intelligent auto	Intelligent auto	Off, On			
		Camera selection	Checked/Not checked			
	VMD alarm	VMD alarm	Off, On			
		Detection sensitivity	1(Low), 2, 3, 4, 5, 6, 7, 8, 9, 10, 11, 12, 13, 14, 15(High)			
		Camera selection	Checked/Not checked			
	VMD alarm (Advanced individual camera setup)	Areas	(Rectangle of Area 1 to Area 4)			
		Status	On, Off			
		Detection sensitivity	1 (low), 2, 3, 4, 5, 6, 7, 8, 9, 10, 11, 12, 13, 14, 15 (high)			
	Schedule 1 to Schedule 4	Schedule mode	Off, Alarm permission (Terminal alarm 1,2,3), Alarm permission (Terminal alarm 1), Alarm permission (Terminal alarm 2), Alarm permission (terminal alarm 3), VMD permission, Preset position: 1, ... Preset position: 8			
		Days (Mon to Sun)	Checked/Not checked			
		Time	00:00 ~ 23:59			
		24 h	Checked/Not checked			
		Camera selection	Checked/Not checked			
Advanced setup	Connection method		RTP, RTSP, Internet mode	RTSP	⊙	
	Do not use stream 2 of camera with each function of this recorder		Checked/Not checked	Not checked	⊙	
	The functions of this product will not change the camera settings automatically		Checked/Not checked	Not checked	⊙	
REC & event						
Recording setup	Schedule1 Days to record	Mon, Tue, ..., Sun		Checked/Not checked	Checked	
	Schedule1 Schedule to record	Time table1	Schedule bar	--:-- , 00:00 - 24:00	Schedule bar 1: 00:00 - 24:00 Schedule bar 2 ~ Schedule bar 6: --:-- - -:--	
			Schedule recording	Checked/Not checked	Checked	
			Event recording	Checked/Not checked	Checked	
			e-Mail	Checked/Not checked	Not checked	
			Alarm notification	Checked/Not checked	Not checked	
	Recording setup (All cameras)	Frame rate		1 ips, 3 ips, 5 ips, 10 ips, 15 ips, 30 ips	10 ips	●
		Image quality		NQ, FQ, SF, XF	FQ	●
		Referenced recording days		(Calculated result will be displayed.)	(Calculated result will be displayed.)	
	Schedule1 Advanced setup	Days to record (Mon, Tue, ..., Sun)		Time table1, Time table2, Off	Time table1	⊙
		Event recording	Event recording duration	2 s, 5 s, 10 s, 20 s, 30 s, 1 min, 2 min, 3 min, 5 min, 10 min, 15 min, Manual, Ext.	30 s	⊙
			Pre-event duration	0 s, 5 s, 10 s, 15 s	0 s	⊙

Menu/Tab	Setting item (including those of the "Advanced setup" menu)		Available range	Default	Remarks	
Recording setup	Schedule1 Advanced setup	Schedule to record	Time table1-Schedule bar	--:-- , 00:00 - 24:00	Schedule bar 1: 00:00 - 24:00 Schedule bar 2 ~ Schedule bar 6: --:-- - -:--	◎
			Time table1-Schedule recording	Checked/Not checked	Checked	◎
			Time table1-Event recording	Checked/Not checked	Checked	◎
			Time table1-e-Mail	Checked/Not checked	Not checked	◎
			Time table1-Alarm notification	Checked/Not checked	Not checked	◎
			Time table2-Schedule bar	--:-- , 00:00 - 24:00	Schedule bar 1 ~ Schedule bar 6: --:-- - -:--	◎
			Time table2-Schedule recording	Checked/Not checked	Checked	◎
			Time table2-Event recording	Checked/Not checked	Checked	◎
			Time table2-e-Mail	Checked/Not checked	Not checked	◎
			Time table2-Alarm notification	Checked/Not checked	Not checked	◎
			Display the schedule list.	(Indication only)	(Indication only)	
			Schedule2 ~ Schedule16 Advanced setup	Days to record (Mon, Tue, ..., Sun)		Time table1, Time table2, Off
	Event recording	Event recording duration			2 s, 5 s, 10 s, 20 s, 30 s, 1 min, 2 min, 3 min, 5 min, 10 min, 15 min, Manual, Ext.	30 s
		Pre-event duration		0 s, 5 s, 10 s, 15 s	0 s	◎
	Schedule to record	Time table1-Schedule bar		--:-- , 00:00 - 24:00	Schedule bar 1 ~ Schedule bar 6: --:-- - -:--	◎
		Time table1-Schedule recording		Checked/Not checked	Checked	◎
		Time table1-Event recording		Checked/Not checked	Checked	◎
		Time table1-e-Mail		Checked/Not checked	Not checked	◎
		Time table1-Alarm notification		Checked/Not checked	Not checked	◎
		Time table2-Schedule bar	--:-- , 00:00 - 24:00	Schedule bar 1 ~ Schedule bar 6: --:-- - -:--	◎	
	Time table2-Schedule recording	Checked/Not checked	Checked	◎		
	Time table2-Event recording	Checked/Not checked	Checked	◎		

Menu/Tab	Setting item (including those of the "Advanced setup" menu)		Available range	Default	Remarks	
Recording setup	Schedule2 ~ Schedule16 Advanced setup	Schedule to record	Time table2-e-Mail	Checked/Not checked	Not checked	⊙
			Time table2-Alarm notification	Checked/Not checked	Not checked	⊙
			Display the schedule list.	(Indication only)	(Indication only)	
	Advanced recording setup	Model	(Registered information will be displayed.)	(Registered information will be displayed.)	⊙	
		Compression	(Registered information will be displayed.)	(Registered information will be displayed.)	⊙	
		Image capture size	When the aspect ratio is 4:3 VGA(640×480)/ SVGA(800×600)/ SXVGA(1280×960)/ UXGA(1600×1200)/ QXGA(2048×1536)/ 5M(2560×1920)/ 7M(3072×2304) When the aspect ratio is 16:9 HVGAW(640×360)/ HD(1280×720)/ FHD(1920×1080)/ WQHD(2560×1440)/ 4M(2688×1520)/ 5M(3072×1728)/ 6M(3328×1872)/ 4KUHD(3840×2160) When the aspect ratio is 1:1 1.4M (1200×1200)*/ 1.6M(1280×1280)/ 2M(1440×1440)*/ 4M(2048×2048)*/ 5M(2192×2192)/ 8M(2816×2816)*/ 9M(2992×2992) When the aspect ratio is 9:16 0.2M(360×640)/ 1M(720×1280)/ 2M(1080×1920)/ 4M(1440×2560)/ 4M(1520×2688)/ 5M(1728×3072)/ 6M(1872×3328)/ 8M(2160×3840)	HVGAW(640×360)	⊙	
		Rate	1 ips, 3 ips, 5 ips, 10 ips, 12.5 ips, 15 ips, 25 ips, 30 ips, 50 ips, 60 ips	10 ips	⊙	
		Quality	NQ, FQ, SF, XF	FQ	⊙	
		Audio	Off, On, On(G.711)*, On(AAC-LC)	Off	⊙ ●	
		Schedule	Schedule1, Schedule2, ..., Schedule16	Schedule1	⊙	
Event		1 ips, 3 ips, 5 ips, 10 ips, 12.5 ips, 15 ips, 25 ips, 30 ips, Same as the basic	Same as the basic	⊙		
Emergency	1 ips, 3 ips, 5 ips, 10 ips, 12.5 ips, 15 ips, 25 ips, 30 ips, Same as the basic	Same as the basic	⊙			
Referenced recording days	(Calculated result will be displayed.)	(Calculated result will be displayed.)	⊙			

* Available only when the camera from other manufacturers is selected.

Menu/Tab	Setting item (including those of the "Advanced setup" menu)	Available range	Default	Remarks	
Event setup	Alarm action	Output duration	0 s, 2 s, 5 s, 10 s, 20 s, 30 s, 1 min, Ext., Rec.	2 s	⊙
		Buzzer duration	0 s, 2 s, 5 s, 10 s, 20 s, 30 s, 1 min, Ext., Rec.	2 s	⊙
		Auto reset time	2 s, 5 s, 10 s, 20 s, 30 s, 1 min, 3 min, 5 min, Ext.	Ext.	⊙
		Message display	Off, On	On	⊙
		Main monitor action	Off, On, On(ACK/RESET)	Off	⊙
		Event type	Checked/Not checked	Terminal alarm: Checked Camera site alarm: Checked Command alarm: Checked	⊙
		Display	Ctrl screen, Wide view	Ctrl screen	⊙
		Display camera	Recording camera, AI privacy guard recording camera	Recording camera	⊙
	Advanced terminal alarm setup	Mode	Off, Recording only, Recording & alarm action	Recording & alarm action	⊙
		Alarm log	Save, Not save	Save	⊙
		Setup by terminal (Recording camera)	Off, Cam.1, ..., Cam.n, All	Terminals 1 to 4: Same camera number as the terminal number Terminals 5 and 6: Off	⊙
		Setup by terminal (Preset)	001 - 256, ---	---	⊙
		Setup by terminal (Terminal output)	Off, On	On	⊙
		Setup by terminal (Terminal input)	N.O., N.C.	N.O.	⊙
		Setup by terminal (Name)	(Text Input)	TRM1, ..., TRM6	⊙
Advanced camera site alarm setup	Mode	Off, Recording only, Recording & alarm action	Recording & alarm action	⊙	
	Alarm log	Save, Not save	Save	⊙	
	Setup by camera (Recording camera)	Off, Cam.1, ..., Cam.n	Camera number	⊙	
	Setup by camera (Preset)	001 - 256, ---	---	⊙	
	Setup by camera (Terminal output)	Off, On	On	⊙	
Advanced command alarm setup	Mode	Off, Recording only, Recording & alarm action	Recording & alarm action	⊙	
	Alarm log	Save, Not save	Save	⊙	
	Setup by command number (Recording camera)	Off, Cam.1, ..., Cam.n	Camera number	⊙	
	Setup by command number (Preset)	001 - 256, ---	---	⊙	
	Setup by command number (Terminal output)	Off, On	On	⊙	
	Setup by command (Name)	(Text input)	CMD1, ..., CMD128	⊙	

* Selectable only when selecting another company's ONVIF camera.

Menu/Tab	Setting item (including those of the "Advanced setup" menu)	Available range	Default	Remarks	
Advanced setup	Recording mode	Off, On	On	⊙	
	Alarm disarm duration	2 s, 3 s, 5 s, 10 s	2 s	⊙	
	TCP alarm port number	(Port No.)	1818	⊙	
	Extension software alarm	Name	(Text will be entered.)	No.1 : Intruder No.2 : Loitering No.3 : Direction No.4 : Cross line No.5: Occupancy Detection Area 1, No.6: Occupancy Detection Area 2, No.7: Occupancy Detection Area 3, No.8: Occupancy Detection Area 4, No.9: User-defined 1, No.10: User-defined 2, ... No.16: User-defined 8	⊙
		Message ID	000 to 255, ---	No.1: 50, No.2: 51, No.3: 52, No.4: 56, No.5: 98, No.6: 99, No.7: 100, No.8: 101 No.9-16: ---	⊙
	Emergency recording	Recording time	30 s, 1 min, 3 min, 5 min, 10 min, 15 min, 30 min, Manual, Ext.	30 s	⊙
	SD backup rec.		Off, On	Off	⊙
	Smart coding (GOP control)		Off, On (Advanced)	Off	⊙ ●
	Special days		Date: 1/1 ~ 12/31 Day: Mon, Tue, Wed, Thu, Fri, Sat, Sun	---	⊙
	Other setup	Make the frame rate of the pre-event recording to the frame rate of the event recording	Checked/Not checked	Not checked	⊙
Do not send the bit rate setting to a camera for which the same frame rate is set for the basic setup, event recording and emergency recording		Checked/Not checked	Not checked	⊙	
Extend an event recording during "MotionAlarm" of ONVIF event		Checked/Not checked	Not checked	⊙	

Advanced setup

Menu/Tab	Setting item (including those of the "Advanced setup" menu)	Available range	Default	Remarks	
Monitor					
Main monitor	Camera title	Display	Off, On	On	⊙
		Position	L-Upper, L-Lower, R-Upper, R-Lower	R-Upper	⊙
		Camera title	(Text will be entered.)	<ul style="list-style-type: none"> •NU300/NU301 CAM1, ..., CAM16 •NU201 CAM1, ..., CAM8 •NU101 CAM1, ..., CAM4 	⊙
	Live sequence (Wide view)	Mode	<ul style="list-style-type: none"> •NU300/NU301 1-screen live sequence, 4-screen live sequence, 9-screen live sequence •NU201 1-screen live sequence, 4-screen live sequence •NU101 1-screen live sequence 	1-screen live sequence	⊙
		Keep aspect ratio	Checked/Not checked	Not checked	⊙
		Duration	3 s, 5 s, 10 s	5 s	⊙
		Camera selection	Checked/Not checked	Checked	⊙
	Other setup	Select multiscreen buttons displaying on wide view operation panel			⊙
		1-screen	Checked/Not checked	Checked, Fixed	⊙
		4-screen	Checked/Not checked	Checked	⊙
		6-screen (NU201/NU300/NU301)	Checked/Not checked	Not checked	⊙
		9-screen (NU201/NU300/NU301)	Checked/Not checked	Checked	⊙
		12-screen (NU300/NU301)	Checked/Not checked	Not checked	⊙
		16-screen (NU300/NU301)	Checked/Not checked	Checked	⊙
		3-screen (unequally divided)	Checked/Not checked	Not checked	⊙
		9-screen (unequal division) (NU201/NU300/NU301)	Checked/Not checked	Not checked	⊙
		16-screen (unequal division) (NU300/NU301)	Checked/Not checked	Not checked	⊙
		3-screen (mixed ratio)	Checked/Not checked	Not checked	⊙
		4-screen (mixed ratio)	Checked/Not checked	Not checked	⊙
		2-screen (vertical)	Checked/Not checked	Not checked	⊙
		3-screen (vertical)	Checked/Not checked	Not checked	⊙
		4-screen (vertical)	Checked/Not checked	Not checked	⊙
		5-screen (vertical)	Checked/Not checked	Not checked	⊙
		6-screen (vertical)	Checked/Not checked	Not checked	⊙
	7-screen (vertical)	Checked/Not checked	Not checked	⊙	
	Other setup				
	Auto-hide the status display panel and the operation panel in wide view	Checked/Not checked	Not checked	⊙	

Menu/Tab	Setting item (including those of the "Advanced setup" menu)		Available range	Default	Remarks
Main monitor	Other setup	Stretch images to fit the areas in control screen display	Checked/Not checked	Not checked	⊙
		Fix the HDMI output to the following video mode	Checked/Not checked	Not checked	⊙
		Fix the HDMI output to the following video mode	4K, 1080p	1080p	⊙
		Activate time-saving playback	Checked/Not checked	Not checked	⊙
		Keep the aspect ratio for the full screen display (Except during live sequence)	Checked/Not checked	Not checked	⊙
Sub monitor	Camera title	Display	Off, On	On	⊙
	Display settings	Mode	<ul style="list-style-type: none"> •NU300/NU301 1-screen live sequence, 4-screen live sequence, 9-screen live sequence, Switch by alarm terminal input, 16Screen •NU201 1-screen live sequence, 4-screen live sequence, Switch by alarm terminal input, 9Screen •NU101 1-screen live sequence, Switch by alarm terminal input, 4Screen 	1-screen live sequence	⊙
		Keep aspect ratio	Checked/Not checked	Not checked	⊙
		Duration	3 s, 5 s, 10 s	5 s	⊙
		Camera selection	Checked/Not checked	Not checked	⊙
		Secret view	Off, On	Off	⊙
Advanced setup	Audio output camera		Selected camera, Cam.1, ..., Cam.n	Selected camera	⊙
	Other setup	Detect a power-off of the sub monitor (HDMI)	Checked/Not checked	Checked	⊙
		Display stream 2 live image when displaying on the monitor with 1-screen display	Checked/Not checked	Not checked	⊙
Network					
Basic	Network Setup	IP address	(IP address)	192.168.0.250	⊙
		Subnet mask	(IP address)	255.255.255.0	⊙
		Default gateway	(IP address)	192.168.0.1	⊙
	DNS Setup	DNS	Off, Manual	Off	⊙
		Primary server address	(IP address)	0.0.0.0	⊙
		Secondary server address	(IP address)	0.0.0.0	⊙
		Domain name	(Text will be entered.)	localdomain	⊙
	DDNS Setup	DDNS	Off, Dynamic DNS update	Off	⊙
		Host name (DDNS update)	(Text will be entered.)	NWDR	⊙
		Access interval	10 min, 20 min, 30 min, 40 min, 50 min, 1 h, 6 h, 24 h	1 h	⊙
	Other setup	HTTP port number	(Port No.)	80	⊙
		Easy IP Setup accommodate period	20 min, Unlimited	20 min	⊙

Menu/Tab	Setting item (including those of the "Advanced setup" menu)	Available range	Default	Remarks	
e-Mail	e-Mail setup	SMTP server address	(Text will be entered.)	(Blank)	⊙
		SMTP port number	(Port No.)	25	⊙
		POP server address	(Text will be entered.)	(Blank)	⊙
		Authentic method	None, POP before SMTP, SMTP	None	⊙
		User name	(Text will be entered.)	(Blank)	⊙
		Password	(Text will be entered.)	(Blank)	⊙
		Sender's address	(Text will be entered.)	NWDR	⊙
		Security	Off, SMTP over SSL, STARTTLS	Off	⊙
		Destination address (Address)	(Text will be entered.)	(Blank)	⊙
		Destination address (Warning)	Checked/Not checked	Checked	⊙
		Destination address (Alarm)	Checked/Not checked	Checked	⊙
TCP alarm notification	TCP alarm notification	Port number(to PC)	(Port No.)	1818	⊙
		Retry	0, ..., 8	2	⊙
		Destination address (Address)	(Text will be entered.)	(Blank)	⊙
HTTP alarm	HTTP alarm	Address	(Text input)	http://	⊙
		User name	(Text input)	(Blank)	⊙
		Password	(Text input)	(Blank)	⊙
		Notification data	(Text input)	/	⊙
		Alarm	Checked/Not checked	Checked	⊙
		Emergency recording input	Checked/Not checked	Checked	⊙
		Camera/Recorder error	Checked/Not checked	Checked	⊙
		HDD/Recording error	Checked/Not checked	Checked	⊙
NTP/SNMP	NTP setup	Time adjustment	Off, On	Off	⊙
		Primary server address	(Text will be entered.)	(Blank)	⊙
		Secondary server address	(Text will be entered.)	(Blank)	⊙
	SNMP setup	SNMP version	Off, SNMPv1/v2, SNMPv3, SNMPv1/v2/v3	Off	⊙
		SNMPv1/v2 - Community	(Text will be entered.)	(Blank)	⊙
		SNMPv1/v2 - Prohibit access from the outside of subnet	Checked/Not checked	Checked	⊙
		SNMPv3 - User name	(Text will be entered.)	(Blank)	⊙
		SNMPv3 - Authentication method	MD5, SHA1	MD5	⊙
		SNMPv3 - Encryption method	DES, AES	DES	⊙
		SNMPv3 - Password	(Text will be entered.)	(Blank)	⊙
		System name	(Text will be entered.)	(Blank)	⊙
		Location	(Text will be entered.)	(Blank)	⊙
		Contact	(Text will be entered.)	(Blank)	⊙
User management					
Basic	Operation	Auto login	Off, On	On	⊙
		Auto login user	(Select from the registered user names.)	(Administrator)	⊙
		Quick login	Off, On	Off	⊙
		Auto logout	Off, After 1 min, After 3 mins, After 5 mins, After 30 mins	Off	⊙

Menu/Tab	Setting item (including those of the "Advanced setup" menu)		Available range	Default	Remarks
Basic	Network	User authentication	Off, On	On	⊙
		Host authentication	Off, On	Off	⊙
	User level settings	Camera operation	Checked/Not checked	Manager: (Checked, Fixed) Operator: (Checked, Fixed) Viewer: (Checked, Fixed) Logged out: Checked	⊙
		Camera control	Checked/Not checked	Manager: (Checked, Fixed) Operator: Checked Viewer: Not checked Logged out: (Not checked, Fixed)	⊙
	User level settings	Search and playback	Checked/Not checked	Manager: (Checked, Fixed) Operator: Checked Viewer: Checked Logged out: (Not checked, Fixed)	⊙
		Copy	Checked/Not checked	Manager: (Checked, Fixed) Operator: Not checked Viewer: Not checked Logged out: (Not checked, Fixed)	⊙
		Alarm reset	Checked/Not checked	Manager: (Checked, Fixed) Operator: Checked Viewer: Not checked Logged out: (Not checked, Fixed)	⊙
		Error reset	Checked/Not checked	Manager: (Checked, Fixed) Operator: Checked Viewer: Not checked Logged out: (Not checked, Fixed)	⊙
		Setup	Checked/Not checked	Manager: (Checked, Fixed) Operator: Not checked Viewer: Not checked Logged out: (Not checked, Fixed)	⊙
		Camera image display	Checked/Not checked	Manager: (Checked, Fixed) Operator: Checked Viewer: Checked Logged out: Checked	⊙
User registration	Register new user	User name	(Text will be entered.)	(Blank)	⊙
		Password	(Text will be entered.)	(Blank)	⊙
		Level	Manager, Operator, Viewer	Operator	⊙

Menu/Tab	Setting item (including those of the "Advanced setup" menu)	Available range	Default	Remarks	
User registration	Register new user	Default screen*	<ul style="list-style-type: none"> •NU300/NU301 Cam.1, ..., Cam.16, 4Screen(1), ..., 4Screen(4), 9Screen(1), 9Screen(2), 16Screen, Sequence(Wide view), 1Screen(Wide view), 4Screen(Wide view), 6Screen(Wide view), 9Screen(Wide view), 16Screen(Wide view) •NU201 Cam.1, ..., Cam.8, 4Screen (1), 4Screen (2), 9Screen, Sequence(Wide view), 1Screen(Wide view), 4Screen(Wide view), 6Screen(Wide view), 9Screen(Wide view) •NU101 Cam.1, ..., Cam.4, 4Screen, Sequence(Wide view), 1Screen(Wide view), 4Screen(Wide view) 	<ul style="list-style-type: none"> •NU201/NU300/ NU301 4Screen(1) •NU101 4Screen 	◎
		Camera partitioning	Common setting, Individual setting	Common setting	◎
		Camera partitioning (Individual setting)	View/Operate, View, Off	View/Operate	◎
Administrator setup	Edit administrator information	Administrator name	(Text will be entered.)	(Blank)	◎
		Password	(Text will be entered.)	(Blank)	◎
		Password (Retype)	(Text will be entered.)	(Blank)	◎
		Level	Administrator	Administrator	◎
		Default screen	<ul style="list-style-type: none"> •NU300/NU301 Cam.1, ..., Cam.16, 4Screen(1), ..., 4Screen(4), 9Screen(1), 9Screen(2), 16Screen, Sequence(Wide view), 1Screen(Wide view), 4Screen(Wide view), 6Screen(Wide view), 9Screen(Wide view), 16Screen(Wide view) •NU201 Cam.1, ..., Cam.8, 4Screen (1), 4Screen (2), 9Screen, Sequence(Wide view), 1Screen(Wide view), 4Screen(Wide view), 6Screen(Wide view), 9Screen(Wide view) •NU101 Cam.1, ..., Cam.4, 4Screen, Sequence(Wide view), 1Screen(Wide view), 4Screen(Wide view) 	<ul style="list-style-type: none"> •NU201/NU300/ NU301 4Screen(1) •NU101 4Screen 	◎
Host registration	Register new host	Host IP address	(IP address)	(Blank)	◎
		Level	Manager, Operator, Viewer	Manager	◎
		Default screen	<ul style="list-style-type: none"> •NU300/NU301 Cam.1, ..., Cam.16 •NU201 Cam.1, ..., Cam.8 •NU101 Cam.1, ..., Cam.4 	Cam.1	◎

Menu/Tab	Setting item (including those of the "Advanced setup" menu)	Available range	Default	Remarks		
Maintenance						
System information	Software version		(Indication only)	(Indication only)	⊙	
	Hardware version		(Indication only)	(Indication only)	⊙	
	Serial number		(Indication only)	(Indication only)	⊙	
	Network port	MAC address		(Indication only)	(Indication only)	⊙
		IP address		(Indication only)	(Indication only)	⊙
		Subnet mask		(Indication only)	(Indication only)	⊙
		Default gateway		(Indication only)	(Indication only)	⊙
		Communication speed (PC port)		(Indication only)	(Indication only)	⊙
	Current PoE total power supply		(Indication only)	(Indication only)	⊙	
	Maximum PoE total power supply		(Indication only)	(Indication only)	⊙	
	Internal temperature		(Indication only)	(Indication only)	⊙	
	Highest temperature		(Indication only)	(Indication only)	⊙	
	SD card information of camera	Software		(Indication only)	(Indication only)	⊙
		SD card model number		(Indication only)	(Indication only)	⊙
		Operation time		(Indication only)	(Indication only)	⊙
		Overwrite time		(Indication only)	(Indication only)	⊙
Backup progress information		(Indication only)	(Indication only)	⊙		
Online user information	Number of login user		(Indication only)	(Indication only)	⊙	
HDD information	Capacity		(Indication only)	(Indication only)	⊙	
	Operation		(Indication only)	(Indication only)	⊙	
	Status		(Indication only)	(Indication only)	⊙	
	Recorded time range		(Indication only)	(Indication only)	⊙	
	Overwrite cycle		(Indication only)	(Indication only)	⊙	
	HDD remaining capacity	Remaining capacity		(Indication only)	(Indication only)	⊙
		HDD remaining capacity notice		Off, 1%, 2%, 3%, 4%, 5%, 6%, 7%, 8%, 9%, 10%	Off	⊙
System management	System setup	Error output duration		0 s, 2 s, 5 s, 10 s, 20 s, 30 s, 1 min, Ext.	2 s	⊙
		Error buzzer duration		0 s, 2 s, 5 s, 10 s, 20 s, 30 s, 1 min, Ext.	2 s	⊙
		HDD hour meter warning		Off, 10000 h, 20000 h, 30000 h, 40000 h, 50000 h	20000 h	⊙
		Auto data delete		Off, 1 day, ..., 10 days, 14 days, 30 days, 45 days, 60 days, 90 days, 120 days, 150 days, 180 days, 184 days, 365 days, 366 days, 730 days, 731 days	Off	⊙
		Camera time auto synchronization		Off, On	On	⊙
		General purpose I/O terminal setting (General purpose 1, General purpose 2)		Undefined, Alarm input, Alarm reset input, Network error output, Recorder error output	Undefined	⊙
		Web browser display mode		Light, Dark	Light	⊙
	Logs	Access log (Date & Time / Log)		(Indication only)	(Indication only)	⊙
		Operation log (Date & Time / Log)		(Indication only)	(Indication only)	⊙
		Network log (Date & Time / Log)		(Indication only)	(Indication only)	⊙

Menu/Tab	Setting item (including those of the "Advanced setup" menu)		Available range	Default	Remarks
System management	Entry information of the key management system	MPR ID	(None)	(Unique number given to the device)	⊙
		Activation Key No.	(None)	Refer to the Activation Key Card.	
		Registration ID	(None)	Refer to the Activation Key Card.	
	Dealer's information		(Text will be entered.)	(Blank)	⊙
	Functions for maintenance	Save data (to USB medium)	(None)	(None)	
		Load data (from USB medium)	(None)	(None)	
		Restoration of the setting values	(None)	(None)	⊙
		Firmware update	(None)	(None)	⊙
		Reset all settings	(None)	(None)	⊙
		Synchronize the camera's time with this unit	(None)	(None)	⊙
		Synchronize the camera's settings with this unit	(None)	(None)	⊙
		Acquire the SD backup data from camera	(None)	(None)	⊙
		Reboot this product	(None)	(None)	⊙
		Boot this product in the board replacement mode.	•NU301 Single mode, Mirroring mode •NU300/NU201/NU101 Single mode	Single mode	⊙
		Clear the maximum temperature record information.	(None)	(None)	⊙
		Reset the maximum PoE total power supply information	(None)	(None)	⊙
		Measure the network transmission/reception speed	(None)	(None)	⊙
		Terminal output test (Terminal)	Camera error output, HDD error output/Recording error output, Alarm output, Network error output, Recorder error output	Camera error output	⊙
		Terminal output test (Output duration)	2 s, 5 s, 10 s	2 s	⊙
	Data output logs	(None)	(None)	★	
OSS	(None)	(None)	★		
HDD management					
General	HDD information	Capacity	(Indication only)	(Indication only)	⊙
		Operation	(Indication only)	(Indication only)	⊙
		Status	(Indication only)	(Indication only)	⊙
		Recorded time range	(Indication only)	(Indication only)	⊙
	Format HDD	HDD information (Capacity)	(Indication only)	(Indication only)	⊙
		HDD information (Operation)	(Indication only)	(Indication only)	⊙
		HDD information (Status)	(Indication only)	(Indication only)	⊙
		HDD information (Format)	Checked/Not checked	Not checked	⊙
		HDD information (Results)	(Indication only)	(Indication only)	⊙

Menu/Tab	Setting item (including those of the "Advanced setup" menu)	Available range	Default	Remarks	
General	Remove HDD	HDD information (Capacity)	(Indication only)	(Indication only)	⊙
		HDD information (Operation)	(Indication only)	(Indication only)	⊙
		HDD information (Status)	(Indication only)	(Indication only)	⊙
		HDD information (Remove)	Checked/Not checked	Not checked	⊙
		HDD information (Results)	(Indication only)	(Indication only)	⊙
	Add HDD	HDD information (Capacity)	(Indication only)	(Indication only)	⊙
		HDD information (Operation)	(Indication only)	(Indication only)	⊙
		HDD information (Status)	(Indication only)	(Indication only)	⊙
		HDD information (Add)	Checked/Not checked	Checked	⊙
		HDD information (Results)	(Indication only)	(Indication only)	⊙
	Change the operation mode of HDD	HDD information (Capacity)	(Indication only)	(Indication only)	⊙
		HDD information (Operation)	(Indication only)	(Indication only)	⊙
		HDD information (Status)	(Indication only)	(Indication only)	⊙
		HDD information (Results)	(Indication only)	(Indication only)	⊙
		Operation mode of HDD	•NU301 Single mode, Mirroring mode •NU300/NU201/NU101 Single mode	(HDD operation mode in use)	⊙
	Security function				
	Communication	Security between this product and PC	Connection	HTTP & HTTPS, HTTPS	HTTPS
TLS 1.2			Checked/Not checked	Checked, Fixed	⊙
TLS 1.3			Checked/Not checked	Checked, Fixed	⊙
HTTPS port number			(Port number)	443	⊙
Download root certificate			(None)	(None)	★
Part number			(Indication only)	(Indication only)	⊙
Address			(Indication only)	(Indication only)	⊙
Connection			(Indication only)	(Indication only)	⊙
Error information			(Indication only)	(Indication only)	⊙
Security between this product and camera		Connection	HTTP, HTTPS	HTTP	⊙
		Port number	(Port number)	443	⊙

About the error logs and the network logs

Error logs

This section describes the display contents on the status display panel of the main monitor, the logs of error occurrence (error logs) and their details.

The display contents of each error logs are common between the main monitor and the web browser.

- "y" indicates the HDD (hard disk drive) number.
- "f" indicates the cooling fan number.
- "cc" indicates the camera number.

Description	Display of the status display panel	Error log	Output from connector
Thermal error warning	Thermal error: MAIN	Thermal error: MAIN	Recorder error
FAN warning	Fan error: MAIN f	Fan error: MAIN f	Recorder error
Camera error detection	Communication error: Cam.cc	Communication error: Cam.cc	Camera error
Camera error recovery	–	Communication recovered: Cam.cc	–
Camera error detection (audio)	Audio communication error: Cam.cc	Audio communication error: Cam.cc	Camera error
Camera error recovery (audio)	–	Audio communication recovered: Cam.cc	–
Video loss (Notification of video input signal loss occurred on the encoder)	Video loss: Cam.cc	Video loss: Cam.cc	Camera error
Video loss recovery (Notification of video input signal loss recovered on the encoder)	–	Video recovered: Cam.cc	–
Recording error detection	Recording error	Recording error (RCA) Recording error (AGT): Cam.cc Recording error (WCK): Cam.cc	HDD error / Recording error
SMART warning	SMART warning: MAIN-y	SMART warning: MAIN-y	HDD error / Recording error
Slow response	Slow response: MAIN-y	Slow response: MAIN-y	HDD error / Recording error
HDD hour meter warning	Hour meter warning: MAIN-y	Hour meter warning: MAIN-y	HDD error / Recording error
HDD skip*	–	HDD skip: MAIN-y HDD skip: MAIN	–
HDD write error	–	Write error: MAIN-y	–
HDD read error	–	Read error: MAIN-y	–
Remove auto links (per HDD)	HDD removed: MAIN-y	HDD logically removed: MAIN-y	HDD error / Recording error
HDD format error	Format error: MAIN-y	Format error: MAIN-y	HDD error / Recording error
HDD removal error (Properly recognized HDD was removed without proper operations.)	Swap warning: MAIN-y	Swap warning: MAIN-y	HDD error / Recording error
Reboot (Related to CPU)	–	System reboot (Related to CPU)	–
Reboot (Related to DEC)	–	System reboot (Related to DEC)	–
Failed to write data on the media	Copy error	Write error: USB	–
Failed to read the data from the media	–	Read error: USB	–
Copy media FULL	–	No available space: USB	–
Number of data on the copy medium exceeded	–	Over limitation: USB	–

* "HDD skip" is a function that allows recording to continue on the next HDD in the recording order in the event of a write error or other problem with the HDD. Skipping speeds up overwritten recording, thus shortening the date/time range of the recorded image. If there is only one HDD, recording will continue from the beginning of that HDD. In this case, the date/time range of the recorded image will be shortened as well.

Description	Display of the status display panel	Error log	Output from connector
Line speed warning (when Auto setting is set to Half)	Line speed warning	Line speed warning: PC port	Network error
When time is not adjusted due to the time difference of 1000 second or more from the NTP server	Skip time adjustment	Skip time adjustment	-
Failed to resolve an address of TCP alarm notification from DNS	-	Address error: TCP ALARM	Network error
No response from a notified address of TCP alarm notification	-	No response: TCP ALARM	Network error
Undefined error of TCP alarm notification	-	Other error: TCP ALARM	Network error
Unable to resolve HTTP alarm notification destination from DNS	-	HTTP alarm address resolution error	Network error
HTTP alarm notification destination no response	-	HTTP alarm no response	Network error
HTTP alarm authentication error	-	HTTP alarm authentication error	Network error
HTTP alarm certificate validation error	-	HTTP alarm certificate error	Network error
HTTP alarm certificate validation warning	-	HTTP alarm certificate warning	Network error
Other error: HTTP alarm address	-	Other error: HTTP alarm	Network error
Starting mirroring recovery	-	Starting mirroring recovery	-
Complete mirroring recovery	-	Complete mirroring recovery	-
Sub-monitor not detected	Sub-monitor not detected	Sub-monitor not detected	-
Camera SD Card error	Backup error: Cam.cc	[SD]Card error: Cam.cc	Camera error
Camera SD Write start failure	Backup error: Cam.cc	[SD]Start error: Cam.cc	Camera error
Camera SD Write end failure	Backup error: Cam.cc	[SD]End error: Cam.cc	Camera error
Camera SD Image acquisition failure	Backup error: Cam.cc	[SD]Get image error: Cam.cc	Camera error
Camera SD Accumulated recording time warning	SD life warning: Cam.cc	[SD]Long-term use warning: Cam.cc	Camera error
Camera SD Overwrite warning	SD life warning: Cam.cc	[SD]Overwrite warning: Cam.cc	Camera error
Camera SD Recording failure	SD recording error: Cam.cc	[SD]Recording error: Cam.cc	Camera error
Camera SD Access error	SD access warning: Cam.cc	[SD]Access warning: Cam.cc	Camera error
Camera SD memory card undetected	SD undetected: Cam.cc	[SD]undetected: Cam.cc	Camera error
Camera SD memory card remaining capacity warning	SD capacity notification: Cam.cc	[SD]capacity notification: Cam.cc	Camera error
Camera SD memory card full	SD no available space: Cam.cc	[SD]no available space: Cam.cc	Camera error
Camera hardware error	Hardware error: Cam.cc	Hardware error: Cam.cc	Camera error
Wiper rubber replacement notice	Wiper rubber: Cam.cc	Wiper rubber: Cam.cc	Camera error
NW camera error detection (video)	Communication error: Cam.cc	Communication error: Cam.cc	Camera error
NW camera error recovery (video)	-	Video communication recovered: Cam.cc	-
HDD remaining capacity notice	-	HDD remaining capacity:1% ~ HDD remaining capacity:10%	-
NW camera error detection (Live)	Communication error (Live): Cam.cc	Communication error (Live): Cam.cc	Camera error
NW camera error recovery (Live)	-	Communication recovered (Live):Cam.cc	-
The trial period for the ext. software of the camera has expired.	Ext. S/W expired: Cam.cc	Ext. software expired: Cam.cc	Camera error
Changed angle of the camera	Changed angle: Cam.cc	Changed angle: Cam.cc	Camera error
Recover angle of the camera	-	Recover angle: Cam.cc	-
PoE total power supply warning	PoE total power supply warning	PoE total power supply warning	Camera error
PoE power supply stopped	PoE power supply stopped	PoE power supply stopped	Camera error
Rollback startup (startup with spare software)	Rollback	Rollback	Recorder error

About the network log

This section describes the details on the network logs and their details. The network logs are displayed by selecting the "Maintenance" page - [System management] tab - [Network log] on the setup menu. Contents to be displayed are the same as when using the web browser.

Description	Network log
E-mail transmission complete	<SMTP>MAIL_SEND
SMTP authentication error	<SMTP>SMTP_ATTEST_ERR
POP3 authentication error	<SMTP>POP3_ATTEST_ERR
Failed to resolve POP3 server address from DNS	<SMTP>POP3_ADD_ERR
Failed to find POP3 server	<SMTP>POP3_SVR_ERR
Failed to resolve SMTP server address from DNS	<SMTP>SMTP_ADD_ERR
Failed to find SMTP server	<SMTP>SMTP_SVR_ERR
MAIL FROM command error	<SMTP>MAIL_FROM_ERR
RCPT TO command error	<SMTP>RCPT_TO_ERR
Other errors for SMTP	<SMTP>OTHER_ERR
Synchronization with the NTP server complete	<NTP>GET_TIME_OK
Failed to resolve NTP server address from DNS	<NTP>SVR_ADD_ERR
Synchronization with the NTP server failed (Time is not synchronized.)	<NTP>TIME_INVALID
Failed to adjust the time	<NTP>SET_TIME_ERR
Failed to find NTP server	<NTP>SVR_ERR
Other errors for NTP	<NTP>OTHER_ERR
Password error for SNMP user name	<SNMP>USER_PASS_ERR
Other errors for SNMP	<SNMP>OTHER_ERR
Password error for HTTP user name	<HTTP>USER_PASS_ERR
HTTP download failure	<HTTP>DOWNLOAD_ERR
HTTP request invalid	<HTTP>REQUEST_ERR
Other errors for HTTP	<HTTP>OTHER_ERR

Operation window

The recorder can be operated using the included mouse connected to the mouse connection port on the recorder. When operating the recorder using a web browser, refer to "Network" (☞ Page 151).

Main monitor (A monitor to display the live image, the playback image and the setup menu)

The main monitor is used to switch between the control screen and the wide view.

Ctrl screen

This screen will be displayed after startup. Main operations of this product can be performed on this screen.



- ① **Image display area**
Displays images from the camera. (☞ Page 107)
- ② **Status display panel**
Displays the statuses of the recorder. Also displays alarm/error status and remedies. (☞ Page 103)
- ③ **Operation panel, Date & time operation panel, Camera control panel**
Used to switch between screens, to play back recordings, operate the camera and so on. Displays the current date & time.
- ④ **[Wide view] button**
Switches the main monitor to wide view display.

Wide view display

This view offers a large image display area, especially suited for monitoring live images. However, operations are restricted.

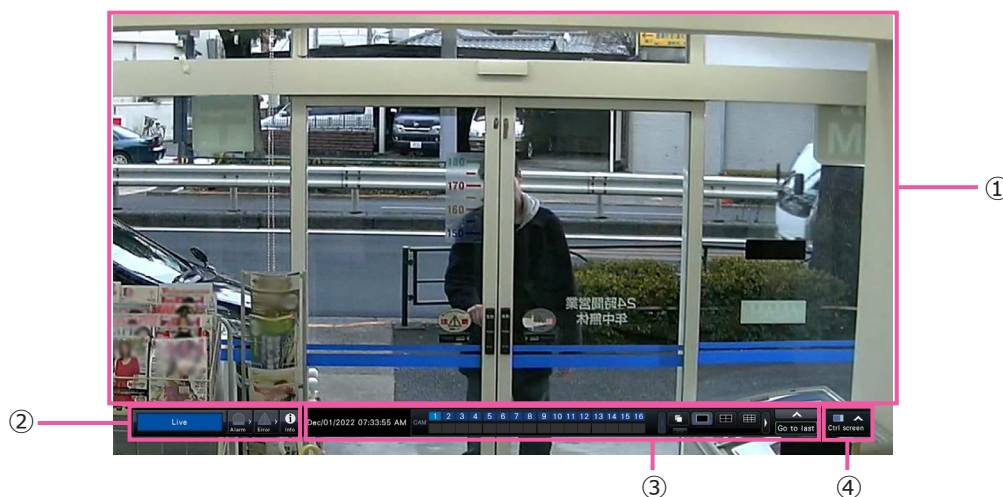

① **Image display area**
Displays images from the camera. (☞ Page 107)

② **Status display panel**
Displays the statuses of the recorder. Also displays alarm/error status and remedies. (☞ Page 103)
When clicking alarm button or error button, this panel may be displayed overlapped on the operation panel.

③ **Operation panel**
Switches between screens and screen patterns, playback recordings and so on.
Displays the current date & time.

④ **[Ctrl screen] button**
Switches the main monitor to control screen display.

Image display area

Playback images and live images will be displayed.

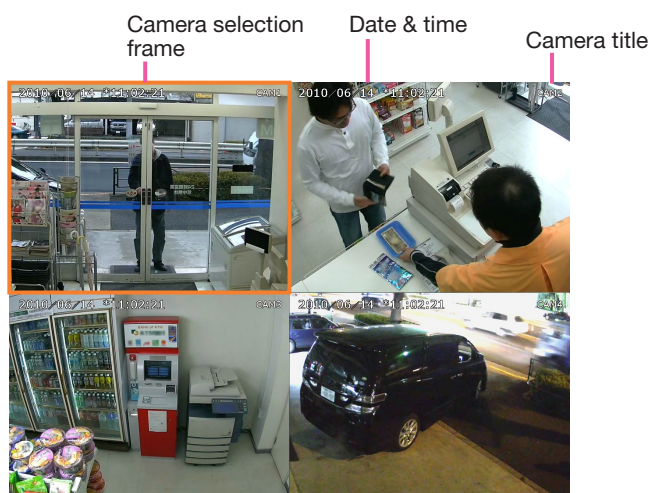

Camera title/date & time

The set camera title will be displayed. The display position can be selected from upper-left ("L-Upper"), lower-left ("L-Lower"), upper-right ("R-Upper") and lower-right ("R-Lower"). The default display position is "R-Upper". (Default: Upper right). Refer to the "Set up the main monitor" section (☞ Page 52) for further information. Date & time will be displayed as set on the camera. The magnification is displayed around the camera title during zoom display in wide view.

Camera selection frame

Displays the camera being operated. When using 1-screen/4-screen display (☞ Pages 114 and 115), the cameras can be operated with the mouse. It is displayed only when the operation screen is displayed.

Image display area

The number of images that can be displayed on the multiscreen differs for the control screen and the wide view screen.

Note:

- It is possible to select whether to display or hide the wide view multi-screen selection button. Refer to the "Set up the main monitor" section (☞ Page 52) for further information.
-

The startup screen to be displayed upon login in the image display area (default screen) can be set for each login user.

The following screens are available for selection.

Refer to page 66 for how to configure the default screen.

Cam.1, ..., Cam.16	: 1 screen for each camera
4Screen (1)	: 4 screens for Cam.1 to 4
4Screen (4)	: 4 screens for Cam.13 to 16
9Screen (1)	: 9 screens for Cam.1 to 9
9Screen (2)	: 9 screens for Cam.10 to 16
16Screen	: 16 screens for Cam.1 to 16
Sequence (Wide view)	: Live sequence display for wide view
1Screen (Wide view)	: 1 screen for wide view
4Screen (Wide view)	: 4 screens for wide view
9Screen (Wide view)	: 9 screens for wide view
16Screen (Wide view)	: 16 screens for wide view

Note:

- If the default screen other than "Cam.1" - "Cam.16" is selected, the default screen of the web browser on the PC will automatically display 1-screen display for Cam.1.
-

About the status display panel

Normal operation



In case of alarm/error (When the associated buttons are displayed)



① Status display area

Recorder status indications and their details are shown in the table below. In the event that the recorder enters several statuses at the same time, these are displayed in their order of priority. If both statuses have the same priority, the one that occurred last will be displayed.

Status	Description	Example	Priority
Live	Live images are being displayed.		6 (Low)
During playback	Recorded images are being played.		6
Downloading SD data	Indicates that SD memory data is being obtained from camera.		4
Copying	Data is being copied. Copying progress is displayed in %.		3
Formatting USB	USB medium is being formatted.		3
Checking HDD	Identifying the HDD.		3
In the alarm state	Indicates an alarm occurrence. Detailed information of the alarm will be displayed.		2
Emergency recording	Emergency recording is on.		2
In the error state	Indicates that an error has occurred. A detailed description of the error content will be displayed.		1
Displaying thumbnail	Thumbnail search screen is being displayed.		0 (High)

② Alarm buttons

Indicate that an alarm has occurred. Turn red in the alarm state. Clicking the buttons will toggle between displaying/not displaying buttons such as the alarm log button and the alarm reset button.

③ Error button

Indicate that an error has occurred. Turn yellow in the error state. Clicking the buttons will toggle between displaying/not displaying buttons such as the error log button and the error reset button.

④ Alarm log display button

The alarm log are displayed on the operation panel of the control screen. Up to 1000 alarm logs are saved. When more than 1000 logs are filed, the older logs will be overwritten by the newer logs. In this case, the oldest log is the first to be overwritten.

⑤ Alarm reset button

Cancels the alarm action. If the recording time of emergency recording is set to "Ext.", the emergency recording will be stopped. Clickable only in the alarm state and emergency recording state.

⑥ Error log display button

The error (trouble) logs are displayed on the operation panel of the control screen. Up to 1000 error logs are saved. When more than 1000 logs are filed, the older logs will be overwritten by the newer logs. In this case, the oldest log is the first to be overwritten.

⑦ Error reset button

Cancels the error (trouble) action. Clickable only in the error state.

⑧ Information display button

Displays system and HDD information of the recorder.

Sub monitor (monitor for display of live images only)

Important:

- Configuration and operation of the recorder from the sub monitor is not possible.
 - When using a sub-monitor, use a full HD (1080p) monitor for the main monitor, or fix the HDMI output signal format to 1080p. (☞ page 53)
-

Live images from the specified cameras can be displayed on 1-screen or multiscreen on the sub monitor, or camera images will be switched sequentially at the selected switching interval (sequence display). In addition, camera images can be switched according to the signal input triggered by a terminal alarm. (☞ Page 54)

Note:

- The date & time and camera also appear on the camera image displayed on the sub monitor, but some characters may be cut off.
 - To display images, it is necessary to select the cameras to be displayed in the setup menu in advance. The recorder is not configured to display camera images by default.
 - Depending on the selected switching interval, a black screen may appear before camera images are displayed.
 - When the secret view function is selected, the single screen on the main monitor or selected images on a multiscreen will not be displayed.
 - While "1-screen live sequence" is being performed, the secret view images will be skipped (not displayed).
 - The image of a camera where an error has occurred will not be displayed.
 - In the live sequence operation, the black image is displayed at the timing when the camera image is switched.
 - The size of displayed images will be fit into the screen regardless of the aspect ratio at the default setting.
 - Depending on whether enabling or disabling the re-encoding transmission, the frame rate or the resolution of camera images on the sub monitor may vary, or the sub monitor may momentarily go black.
 - Depending on the re-encoding transmission, the frame rate of the displayed camera image may change or a momentary black image may appear.
-

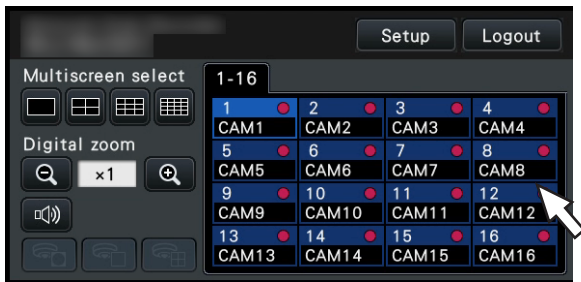

Basic operations



To operate, use the mouse connected to the recorder to move the mouse cursor displayed on the main monitor and left-click the buttons or tabs displayed on the screen. (Hereinafter, "Left-click..." will be described as "Click..." in this document.)

In lines where the [▲]/[▼] buttons are displayed, the value on which the cursor is placed can be changed by turning the mouse wheel. For example, when setting date & time, the hours, minutes and seconds can be changed.

The shape of the mouse cursor will change as follows depending on the display screen and mouse operation.

-  : Normal operation
-  : When dragging a camera number panel (wide view screen)

Note:

- When no operation is made for 10 seconds or more, the mouse cursor will be hidden. The mouse cursor will be displayed again when the mouse is moved.
 - It is impossible to connect a mouse to the mouse connection port if the connector from the mouse is upside down. When it is hard to connect, check the upside down position of the connector.
-

Logout

Click the [Logout] button. To log out, click the [OK] button in the confirmation window displayed.

Note:

- If "On" is selected for the "Auto login" (☞ Page 63), login will be automatically performed by the user registered in "Auto login user" in the logged-out state.
-

Login operation at startup

When "Off" is selected for "Auto login" (Page 63), the recorder will start up in the logged-out state after completing the system check.

When the operation window is displayed on the main monitor, enter a user name and password as follows:

Step 1

Click the [Login] button on the operation screen.

→ The "Login" window will be displayed.

Step 2

Enter a user name and password using on-screen keyboard.



- Refer to page 65 for how to register users.

Note:

- When "On" is selected for "Quick login", the user name can be selected from the pull-down menu. The password entered will be displayed as "*" marks.
- In the logged-out state or when a user other than administrative or manager privileges is logged, the login window will be displayed if tries to operate an unauthorized function.

Step 3

Click the [OK] button.

→ When the entered user name and password are correct, the login window will disappear and the login button will change to the logout button. When the entered user name and password are incorrect, the error window will be displayed. Close the error window and log in again.

Note:

- The administrator is not registered when the recorder is purchased. Enter an administrator name, a password and the password retyping following the instruction on the display and click [Registration] as "Administrator registration" screen is displayed on the main monitor when you first launch the recorder.
- To enhance the security, change the administrator name and the password periodically. Refer to page 65 for how to change the password.
- To log out, click the [Logout] button on the operation screen.
- When a user logs out during copying, the copying will be canceled. (When operating the recorder using a web browser, it will take around 90 seconds until copying is stopped after the web browser is closed.) When the auto logout function is activated, logout will be executed when the specified time have passed after copying is completed.
- Displaying images in the logged-out state
After startup with "Auto login" set to "Off", the "4Screen" will be displayed.
When logging out during the login process, the same screen as right before logout will be displayed.
(Which camera images the user is authorized to display depends on the user level set up.)
- When "On" is selected for "Auto login", it is unnecessary to perform the operations described on this page.

Monitor live images

When the recorder started up, live images from cameras will be displayed according to the configured settings. Live images from cameras are displayed via the recorder.

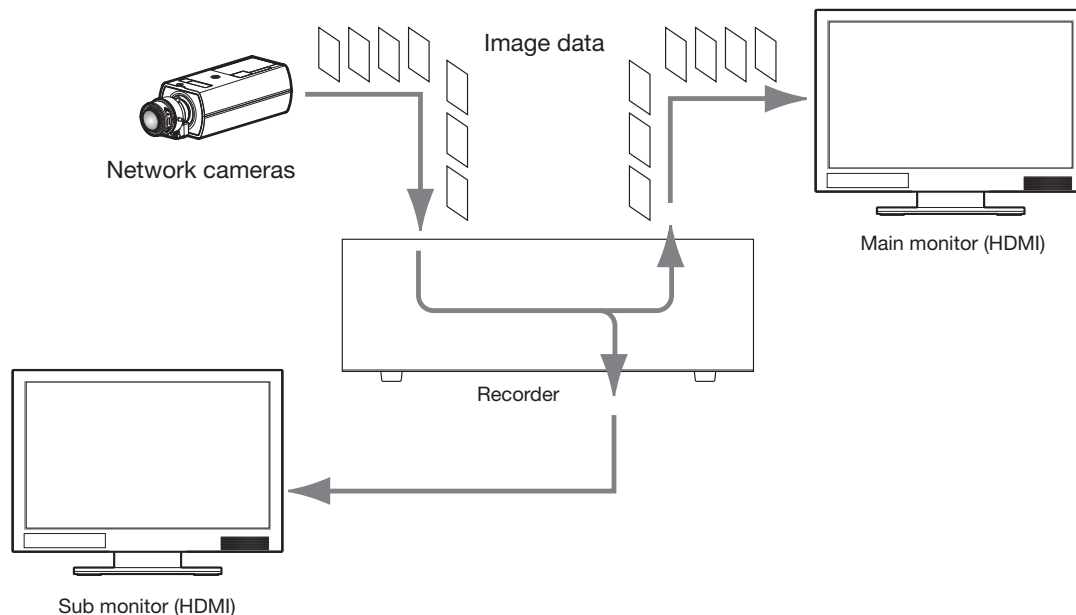

It is possible to display live images on a 1-screen or on a multiscreen. Depending on the configuration of the sub monitor, the cameras can automatically be switched and images from the cameras can be displayed on 1-screen or multiscreen. (Page 54)

When displaying images from the camera for which "On" is selected for "Audio" under "Recording setup" (Page 43), audio captured by the camera will be output. When displaying images on a multiscreen, audio from the selected camera will be heard.

Note:

- Depending on the camera in use or network environment, the audio of live images from the camera may be delayed, but that may not affect the audio output from recorded images.
- Update processing of audio data will be performed to synchronize live images with audio. Due to the processing, the audio of live images from the camera may be momentarily interrupted, but that may not affect the audio output from recorded images.
- When using a 4K-compatible monitor, also refer to "Restrictions when using this product" (page 5).

About the operation panel

Operations with live images differ depending on whether they are performed on the control screen or on the wide view screen.

Control screen / Operation panel

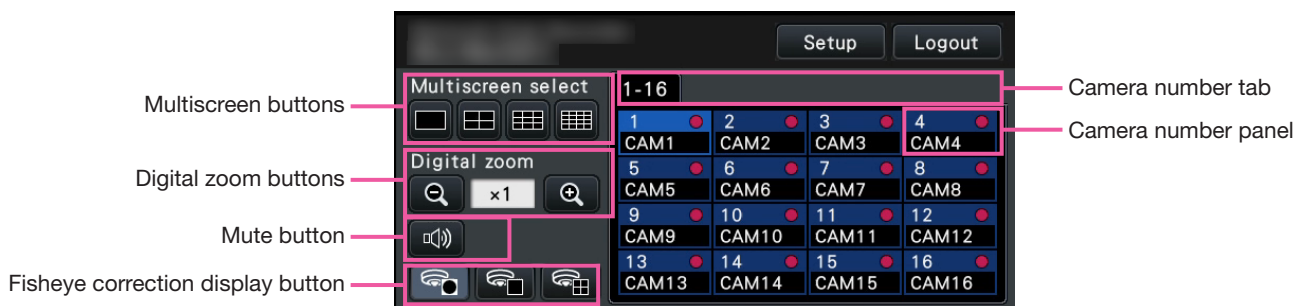

Multiscreen buttons

The buttons switch the number of split screens in the image display area.

Digital zoom buttons

When displaying images on a 1-screen or 4-screen, the images can be enlarged/reduced. (☞ Page 116)

Mute button

Each click of this button toggles between mute and mute cancel of the camera audio.

Fisheye correction display button

Fisheye display button

Returns to the fisheye image display.

1-screen PTZ display button

Corrects the fisheye image and displays on the 1-screen PTZ.

4-screen PTZ display button

Corrects the fisheye image and displays on the 4-screen PTZ.

Only when the camera image is displayed on a 1-screen in a control screen, will the fisheye correction display button be displayed.

Camera number tab

: Displays the camera number panel to display.

Camera number panel

Camera number:

(Character color)

White: Camera is registered.

Gray: Camera is not registered.

(Background color)

Aqua: Image display area is displaying images

Blue: Camera is registered and image display area is not displaying images.

Gray: Recording is not possible or camera is not registered.

Camera title: Shows the first 8 characters of the previously entered camera title.

(Character color)

Same as camera number

(Background color)

Red: Event recording is being performed.

Black: Other than the above.

Recording indicator: Lights red when recording is being performed. Display of [] indicates a connection error.

Wide view operation panel

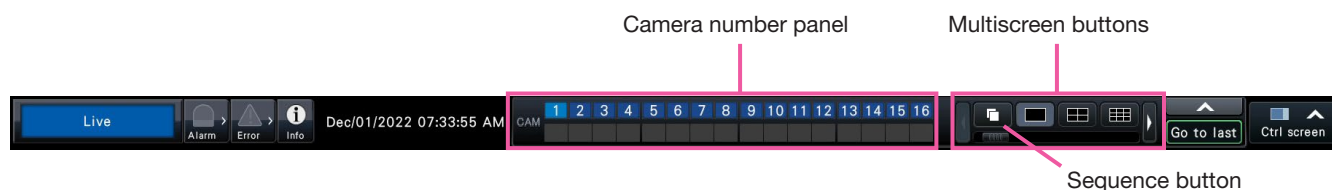

Camera number panel

Camera number [CAM]:

(Character color)

White: Camera is registered (in the recording).

Black: Camera is registered (not in the recording).

Gray: Camera is not registered.

(Background color)

Aqua: Image display area is displaying images

Blue: Camera is registered and image display area is not displaying images.

Gray: Recording is not possible or camera is not registered.

Red: Event recording is being performed.

Multiscreen buttons

The buttons switch the number of split screens in the image display area.

Note:

- It is possible to hide/display the multi-screen selection buttons on the operation panel. Refer to the "Configure the settings relating to monitors" sections (Page 53) for further information.
- When 5 or more multi-screen selection buttons are displayed, it is possible to switch the position of displayed buttons using the left/right buttons or the slider.

Sequence button

: Clicking of a sequence button can start the sequence. Clicking any multiscreen buttons other than the sequence button will terminate the sequence.

Note:

- During the sequence, the dragging & dropping of the camera number panel onto live images can't switch over camera images.
- During the sequence, the audio is not output. When fixing the audio output in "Audio output camera" found in the "Advanced Setup" section under "Monitor", the audio will be output.
- While recorded images are being played back, the sequence can't be started.
- Setting "Sequence(Wide view)" on the "Default screen" under "User Management>User registration" and "User management>Administrator setup" will start the sequence after login.
- In the 9-screen live sequence, the black image is displayed at the timing when the camera image is switched.

Change the camera display position on the screen

The default camera display positions are as follows:

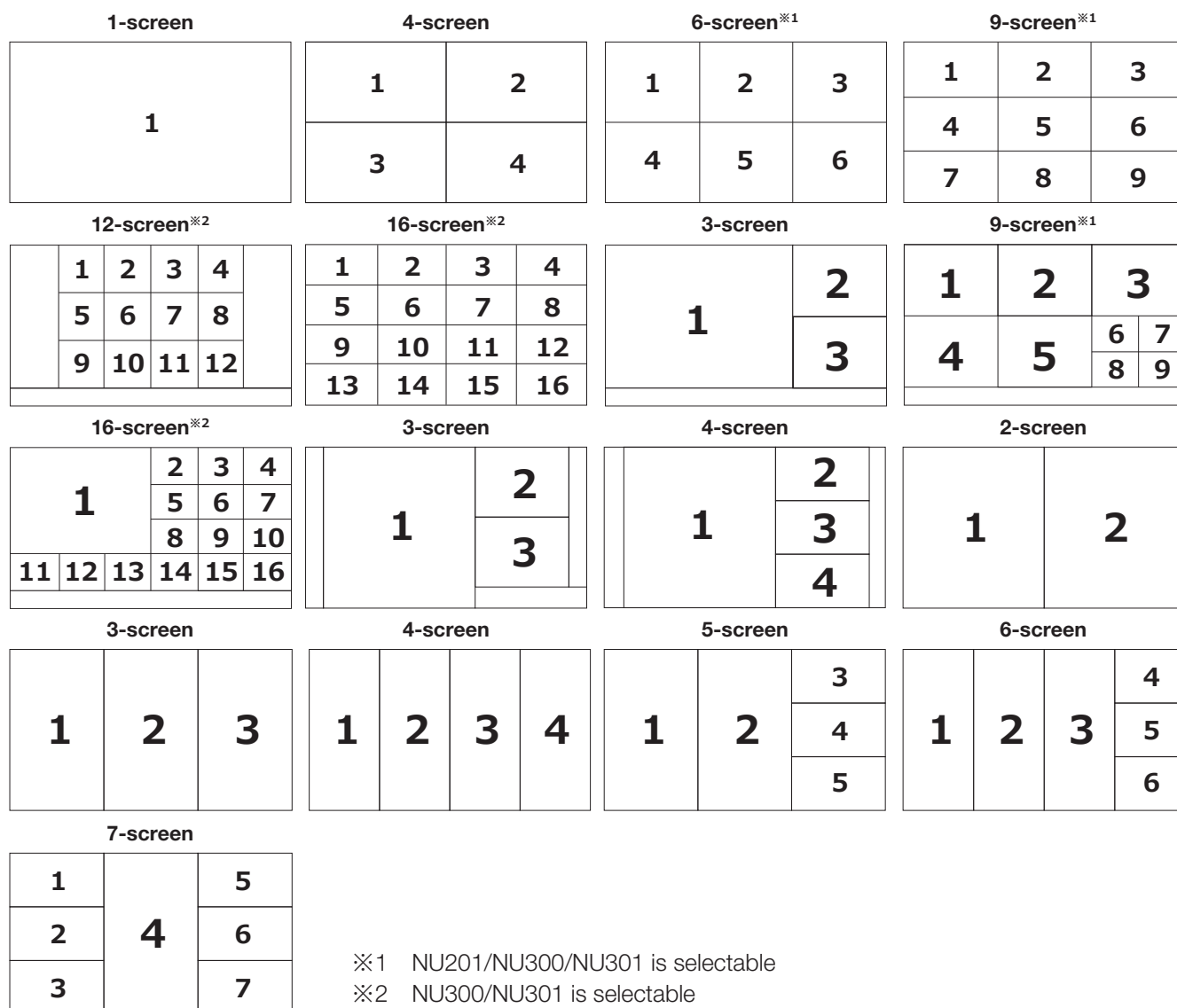

It is possible to change the camera image by dragging & dropping the number of the camera number panel onto the desired display position. The position of the camera display can be replaced by the right-click menu on the image.

Note:

- When a camera is assigned to a screen segment to which another camera is already assigned, the image of the camera originally assigned to that position will disappear.
- The assigned camera position is retained even if the recorder is rebooted (note however that initializing the settings will also reset the camera positions to the defaults).
- The audio of the camera assigned to the top left position will be output.
- If "Mute" was selected on the control screen, no audio will be output.
- By default, the size of displayed images will be fit into the screen regardless of the aspect ratio if the aspect ratio of the original image is 4:3 or 16:9. Refer to page 53 for settings to keep the aspect ratio.

[Operation via recorder's main monitor]

If the compression method of the registered camera is JPEG, then depending on the resolution setting and operational configuration, it may not be possible to display live images in multiple screens.

Main monitor (1080p monitor connection)

[No sub-monitor display, no re-encoding transmission]

Image capture size	HVGAW(640×360) ~ FHD(1920×1080)	QXGA(2048×1536) ~ 4KUHD(3840×2160)	9M(2992×2992)
Multiscreen display			
1-screen to 4-screen display	○	○	○
5-screen to 7-screen display	○	○	×
9-screen to 16-screen display	○	×	×

[Sub-monitor display or re-encoding transmission available]

Image capture size	HVGAW(640×360) ~ SXVGA(1280×960)	1.4M(1200×1200) ~ 9M(2992×2992)
Multiscreen display		
1-screen to 4-screen display	○	○
5-screen to 16-screen display	○	×

Main monitor (4K monitor connection)

[No sub-monitor display, no re-encoding transmission]

Image capture size	HVGAW(640×360) ~ FHD(1920×1080)	QXGA(2048×1536) ~ 5M(3072×1728)	6M(3328×1872) ~ 9M(2992×2992)
Multiscreen display			
1-screen display	○	○	○
2-screen to 7-screen display	○	○	×
9-screen to 16-screen display	○	×	×

[Sub-monitor display or re-encoding transmission available]

Image capture size	HVGAW(640×360) ~ SXVGA(1280×960)	1.4M(1200×1200) ~ 5M(3072×1728)	6M(3328×1872) ~ 9M(2992×2992)
Multiscreen display			
1-screen display	○	○	○
2-screen to 4-screen display	○	○	×
5-screen to 16-screen display	○	×	×

Sub monitor

Image capture size	HVGAW(640×360) ~ 0.4M(640×640)	SVGA(800×600) ~ FHD(1920×1080)	QXGA(2048×1536) ~ 5M(3072×1728)	6M(3328×1872) ~ 9M(2992×2992)
Multiscreen display				
1 screen	○	○	○	○
4 screen	○	○	○	×
9-screen, 16-screen display	○	×	×	×

When the compression method of the registered camera is H.264/H.265, stream 2 (H.264(2) or H.265(2)) is not used, such as 4-stream mode for omnidirectional cameras

During operation, it may not be able to display live images in multiple screens.

Main monitor (1080p monitor connection)

[No sub-monitor display, no re-encoding transmission]

Image capture size	HVGAW(640×360) ~ FHD(1920×1080)	QXGA(2048×1536) ~ 4KUHD(3840×2160)	9M(2992×2992)
Multiscreen display			
1-screen to 4-screen display	○	○	○
5-screen to 7-screen display	○	○*2	×
9-screen to 16-screen display	○	×	×

[Operation via recorder's main monitor]

[Sub-monitor display or re-encoding transmission available]

Image capture size Multiscreen display	HVGAW(640×360) ~ FHD(1920×1080)	QXGA(2048×1536) ~ 5M(3072×1728)	6M(3328×1872) ~ 9M(2992×2992)
1-screen display	○	○	○
2-screen display	○	○	×
3-screen, 4-screen display	○	○*2	×
5-screen to 16-screen display	○	×	×

Main monitor (4K monitor connection)

[No sub-monitor display, no re-encoding transmission]

Image capture size Multiscreen display	HVGAW(640×360) ~ FHD(1920×1080)	QXGA(2048×1536) ~ 5M(3072×1728)	6M(3328×1872) ~ 9M(2992×2992)
1-screen display	○	○	○
2-screen to 4-screen display	○	○	×
5-screen to 7-screen display	○	○*2	×
9-screen to 16-screen display	○	×	×

[Sub-monitor display or re-encoding transmission available]

Image capture size Multiscreen display	HVGAW(640×360) ~ FHD(1920×1080)	QXGA(2048×1536) ~ 5M(3072×1728)	6M(3328×1872) ~ 9M(2992×2992)
1-screen display	○	○	○
2-screen display	○	○	×
3-screen, 4-screen display	○	○*2	×
5-screen to 16-screen display	○	×	×

Sub monitor

Image capture size Multiscreen display	HVGAW(640×360) ~ 0.4M(640×640)	SVGA(800×600) ~ FHD(1920×1080)	QXGA(2048×1536) ~ 5M(3072×1728)	6M(3328×1872) ~ 9M(2992×2992)
1 screen	○	○	○	○
4 screen	○	○*1	○*2	×
9-screen, 16-screen display	○	×	×	×

*1 If the frame rate setting for recording exceeds 30 ips, the display will follow the refresh interval set for the camera.

*2 If the frame rate setting for recording exceeds 15 ips, the display will follow the refresh interval set for the camera.

Switch between control screen and wide view screen

Camera images will be displayed on a full screen.

[Wide view] button of the control screen

[Ctrl screen] button of the wide view screen

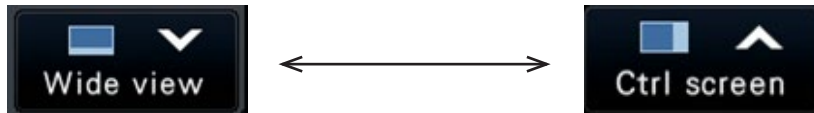

Step 1

Click the [Wide view] button (☐ Page 100) on the operation window.

→ Images from the camera will be displayed on a full screen. The 1-screen is displayed by default.

Step 2

To return from the full screen to the control screen, click the [Ctrl screen] button.

→ The display reverts to the control screen. The image display area corresponds to the default screen set up by the login user. When a wide view screen is set as the default screen, "4Screen" will automatically be applied.

Note:

- Clicking the [Wide view] button again will switch to the multiscreen displayed before.

1-screen display

Live images from cameras can be displayed on a 1-screen.

Displaying images on a control screen

Step 1

When displaying in a multi-screen, click the 1-screen button of the "Multiscreen select".

→ The image will be displayed on a 1-screen.

Step 2

Click the camera number panel of the desired image from the camera.

→ The background color of the selected camera number will turn aqua, and live images will be displayed.

Camera No. box in the control screen

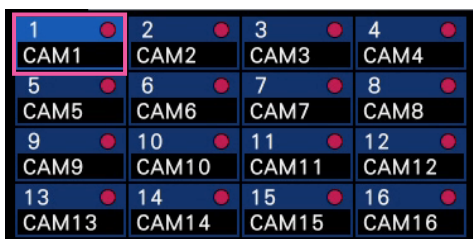

If a camera that you want to display is not on the

Displaying images on a wide view

Step 1

When displaying in a multi-screen, click the 1-screen button of the "Multiscreen select".

→ The image will be displayed on a 1-screen.

Step 2

Drag the camera No. to be displayed over the live image and drop it.

→ The background color of the selected camera number will turn aqua, and live images will be displayed.

Camera No. box in the wide view screen



camera number panel, select it on the camera number tab and move to Step 2.

Note:

- Another way to display images on a 1-screen is to double-click the camera number panel of the camera to be selected in the image display area.
- In the multiscreen display area, double-clicking the camera selection frame is also possible to display an image on a 1-screen.
- The audio of the camera whose images are being displayed will be output. (It is possible to fix audio to be output on "Audio output camera" under "Advanced setup" under "Monitor".)
- At the default, black zones will be displayed on the top and bottom of images with the aspect ratio of 16:9. Refer to page 53 for the setting to enlarge the vertical size of displayed images.

Note:

- The camera can be selected by the right-click menu on the image display area.
- The audio of the camera whose images are being displayed will be output. (It is possible to fix audio to be output on "Audio output camera" under "Advanced setup" under "Monitor".)

Display images from cameras on a multiscreen

Live images from cameras can be displayed on a multiscreen.

Displaying images on a control screen

Step 1

Click one of the [Multiscreen select] buttons.

→ Live images from cameras will be displayed on a multi-screen.

Displaying images on a control screen

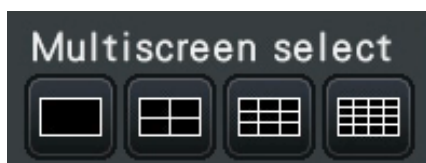

- 4-Screen button
4-screen display includes the currently selected camera. Each time the button is clicked, the display switches between four screens: Cam.1 - 4 → Cam.5 - 8 → Cam.9 - 12 → Cam.13 - 16, and so on.
- 9-Screen button (NU201/NU300/NU301)
9-screen display includes the currently selected camera. Each time the button is clicked, the display switches between 9 screens, from Cam.1 to 9, then Cam.10 to 16, and so on.
- 16-Screen button (NU300/NU301)
Displayed on 16 screens.

Note:

- After having switched from multiscreen display to 1-screen display, double-clicking the image display area will display the multiscreen displayed before switching screens.
- The display can also be switched between 4-screen/9-screen/16-screen by clicking on the camera number panel in the 4-screen/9-screen/16-screen mode. (Clicking on the panel for Cam.5 while 1 to 4 are displayed will display 5 to 8.)
- The audio of the selected camera will be output. (It is possible to fix audio to be output on "Audio output camera" under "Advanced setup" under "Monitor".)
- At the default, black zones will be displayed on the top and bottom of images with the aspect ratio of 16:9. Refer to page 53 for the setting to enlarge the vertical size of displayed images.

Displaying images on a wide view

Step 1

Click one of the [Multiscreen select] buttons.

→ Live images from cameras will be displayed on a multiscreen.

[Multiscreen select] button of the wide view screen



Note:

- Cameras displayed on the multiscreen can be changed. Read Step 2 described in "Displaying images on a wide view" of "1-screen display".
- Clicking the sequence button can switch camera images automatically (live sequence display). The settings related to the live sequence display can be performed at "Live sequence (Wide view)" of [Monitor]-[Main monitor].
- The audio of the camera assigned to the top left position will be output. (It is possible to fix audio to be output on "Audio output camera" under "Advanced setup" under "Monitor".)

Use digital zoom

Images on the 1-screen or 4-screen of the control screen, or the 1-screen in wide view can be digitally zoomed. It is also possible to move the zoomed area within the displayed image.

Displaying images on a control screen

Note:

- The digital zoom cannot be used when 9-screen/16-screen are displayed.
- To use this function on the 4-screen, do so after first selecting the desired camera image. To select a camera, click the camera number panel or the camera image. Once a camera has been selected, the selection frame will be displayed around the camera image.

Step 1

Confirm that the image display area is displayed on the 1-screen or 4-screen.
(when displaying on the 4-screen, select the camera whose image is to be zoomed)

Step 2

Click the digital zoom buttons .

→ The displayed image will be enlarged $\times 1$, $\times 1.25$, $\times 1.50$, $\times 1.75$, $\times 2$, $\times 2.5$, $\times 3$, $\times 3.5$, $\times 4$, $\times 5$, $\times 6$, $\times 7$, $\times 8$ centering on the center point of the screen.

Digital zoom buttons

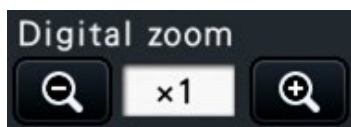

Note:

- Clicking a point in the zoomed image makes the clicked point the center of the image.

Displaying images on a wide view

Step 1

Confirm that the image display area is set to the 1-screen.

Step 2

Use the mouse wheel.
→ Zooming is switched by $\times 0.25$ from $\times 1$ to $\times 2$, by $\times 0.5$ from $\times 2$ to $\times 4$ and by $\times 1$ from $\times 4$ to $\times 8$ centering the position of the mouse cursor.
Click of the image during zoom display changes the center to the clicked position.

- If "Enable camera control with mouse" on the camera control panel (☞ Page 118) is not checked, the digital zoom factor can also be changed by placing the cursor on the image in the image display area and turning the mouse wheel. In this case, the point where the mouse cursor is positioned will become the zoom center.

Step 3

Click the digital zoom button  to zoom out the image by the magnification opposite to the Step 2.

Note:

- Digital zoom is automatically canceled by other operations such as selecting another camera or changing the screen pattern.

Note:

- The magnification is displayed around the camera title during the zoom display. If the camera title is not displayed, the zoom magnification will not be displayed. You can set whether to display the camera title in the [Main monitor] tab of the monitor page. (☞ Page 52)
- Digital zoom is automatically canceled by other operations such as selecting another camera or changing the screen pattern.

Correct the fisheye image

The Fisheye image can be corrected and displayed while the fisheye image is displayed on the 1-screen in the image display area of the control screen.

Note:

- The fisheye correction display is not available in wide view and on the multiscreen. The fisheye correction display button is not displayed.
- During the corrected display of fisheye images, the live images of the sub-monitor are displayed at the refresh rate set for the camera.
- When a 4K monitor is connected to the main monitor and a sub-monitor is also used, fisheye image correction display and re-encoding transmission cannot be used at the same time. Re-encoding transmission will stop if the corrected display of the fisheye image is performed during re-encoding transmission.

Step 1

Confirm that the image display area is set to the 1-screen display of the fisheye image on the control screen.

Step 2

Click the 1-screen PTZ display/4-screen PTZ display button.

→ Corrects the fisheye image and displays on the 1-screen PTZ/4-screen PTZ. Images of the following angle of view will be displayed respectively.

■ 1-Screen PTZ display

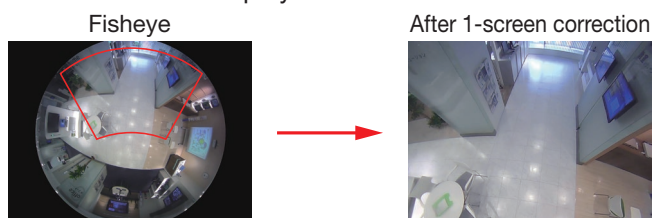

■ 4-Screen PTZ display

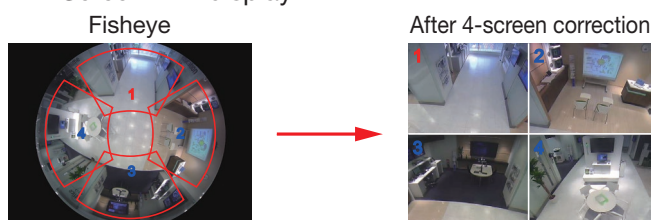

Fisheye correction display button



Note:

- Double-click of the right mouse button on the fisheye image can correct the image and display on the 1-Screen PTZ centering the cursor position.
- Click on the image during the 1-Screen PTZ correction display can change the center to the clicked position. Click an image that you want to change the display position, and then click on the image during the 4-Screen PTZ correction display.
- The clicked position may not come to the center depending on the clicked position.
- Digital zoom (see page 116) is possible during correction display.
- The correction display position of the fisheye image cannot be changed by operating the buttons on the camera control panel (see page 118).
- Double-click on the image during the 4-Screen PTZ correction display can switch the screen to the 1-Screen PTZ correction display (and vice versa).
- The high resolution image and high frame rate image may not be corrected and displayed based on the original frame rate.

Step 3

Click of the fisheye display button releases the correction function.

Note:

- The correction display position of the fisheye image is recorded after the recorder is turned off. If the fisheye image is corrected and displayed in 1-Screen PTZ after the recorder is turned on, it will be corrected and displayed on the previous position immediately before it was turned off.
- The split line is displayed on the image in a moment when the correction function is canceled from the 4-Screen PTZ correction display.

Operate the camera

When displaying live images from a camera with the panning/tilting function on a 1-screen or 4-screen, the following camera operations are available.

Note:

- It may be impossible to operate the camera or some functions may be inoperable depending on the model of the camera.
- Operations are performed from the operation window. When working with the wide view screen, open a 1-screen or 4-screen operation window by clicking the [Ctrl screen] button in the bottom right corner of the screen.
- For a fixed camera, the buttons on the camera control panel and other controls will be disabled.

Camera control panel

Operate the cameras displayed as selected (inside selection frame) in the image display area. On the 1-screen, the camera whose image is currently displayed, can be operated. On the 4-screen, click the camera number panel on the operation panel, or select a camera image by clicking it in the image display area.



Control buttons

Move (pan/tilt) the camera in the clicked direction. Keeping the button pressed will move the camera continuously.

[Zoom] button

Adjusts the zoom factor.

[Home position/Call] button

Move the camera to the home position.

[Enable camera control with mouse] checkbox

When this item is checked, pan/tilt (clicking) and zoom (mouse wheel) can be controlled with the mouse on the selected camera image.

Note:

- When this checkbox is marked, digital zooming (Page 116) by turning the mouse wheel operation is not possible. When the camera control panel is inoperable for the fixed camera, the digital zoom can be performed by turning the mouse wheel even when the checkbox is checked.

[Detail] button

Display the "Camera control [Advanced]" panel, and perform any of the following camera operations.



[Focus] button

Adjust the focal point.

[Brightness] button

Adjusts the lens iris of the camera.

Auto mode

Activates the auto mode function of the camera.

[Operation via recorder's main monitor]

[Position]

Registers the current orientation of the camera as a preset position. Moves the camera to a previously registered preset position.

When the page is switched to 2/2 with a button on the top right of the detailed control panel, the following camera operation can be performed.



[AUX] button

Sets the device connected to the AUX terminal of the camera to the open/closed state.

If the camera is a network camera, AUX1, 2 and 3 is controlled with only AUX1 of the camera.

If the device is the encoder GXE500, the AUX1 and 2 control terminals of a camera or a receiver (WV-RC150) are applicable for each analogue camera connected to it.

The AUX3 controls the AUX output terminal (1 system only) of GXE500.

[Wiper] button

Operates the washer/wiper of the WV-SUD638.

[Setup] button

Displays the camera setup window for registering a home position (☞ Page 121), executing auto back focus (☞ Page 121), etc.

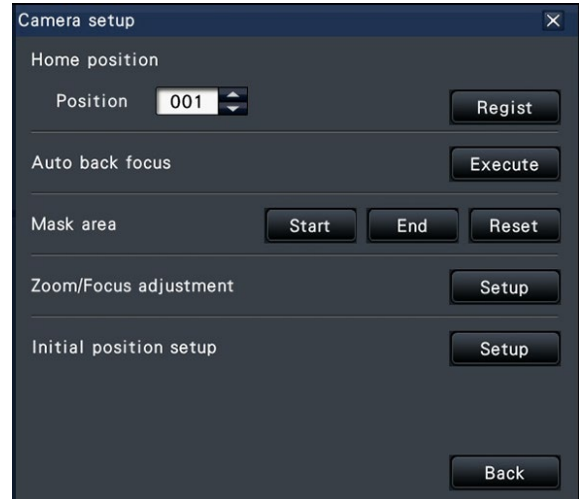

[Back] button

Closes the "Camera control [Advanced]" and returns to the camera control panel.

Note:

- Controlling the camera is not possible on the wide view screen or 9-screen/16-screen display.
-

[Operation via recorder's main monitor]

Camera operation is as follows.

Note:

- For 4-screen display, select the camera to be operated.

Function	Function Description	Operation
Pan/Tilt	Adjusts the horizontal/vertical position of the camera image.	Click the control button on the camera control panel. Also, if you have checked "Operate camera with mouse", when you click the position in the camera image that you want to use as the center of the angle of view, the direction of the camera moves to center on the clicked position.
Zoom	Operates the zoom of the camera lens to enlarge/reduce the camera image.	Click the [-] or [+] button on the camera control panel. Click the [x1] button to return the zoom magnification to 1x. Also, if you check "Operate camera with mouse", you can adjust the zoom by operating the mouse wheel on the camera screen. Note When you select the area you want to display by dragging the mouse, the direction of the camera moves to the position centered on the selected area, and the zoom magnification is automatically adjusted.
Move to home position	Move the direction of the camera to the home position registered in advance.	Click the [Move] button in the home position of the camera control panel. Note Register the home position in advance.
Focus	Adjusts the focus of the camera image.	Click the focus [zoom in] or [zoom out] button on the advanced camera control panel. Click the [Auto] button to automatically adjust the focus.
Brightness	Adjusts the aperture of the lens.	Click the [Dark (-)] or [Bright (+)] button for brightness on the advanced camera control panel. Click the [Standard] button to return brightness setting to standard.
Auto mode	Activates the Auto mode function set in the camera.	Click the [▼] button for the Auto mode in the advanced camera control panel to select the following Auto modes. Click the [START] button to start the camera in Auto mode. Click the [Exit] button to exit the Auto mode. <ul style="list-style-type: none"> • Auto-Following/Tracking: The camera automatically tracks objects moving on the screen. • Auto Pan: The camera automatically rotates within the range of the pan start and end positions as set in advance. • Preset Sequence: Moves through the preset positions registered in advance in the camera, starting with the lowest preset number. • Patrol: Performs the operations recorded in advance by the camera. Note Set the Auto mode in the camera menu before use.
Preset registration	Registers the current camera orientation to the selected preset position.	Perform pan/tilt operations on the advanced camera control panel to move the camera in the direction you want to register. Click the [▲]/[▼] buttons for "Preset" and select the preset number (1 to 256) you want to register. Click the [Register] button, and then click the [OK] button on the confirmation screen. Note Some preset numbers cannot be registered depending on the connected camera model.

[Operation via recorder's main monitor]

Function	Function Description	Operation
Preset move	Moves the camera orientation to the position preset in the preset registration.	Click the [▲]/[▼] buttons for "Preset" on the advanced camera control panel, select a preset number (0 to 256), and click the [Move] button. Note Select preset number 0 to move to the home position.
AUX operation	Opens/closes the device connected to the AUX terminal of the camera.	Click the page switch button at the top right of the advanced camera control panel screen to switch the panel to 2/2. Select the AUX terminal number from the pull-down menu, then click the [Open]/[Close] buttons. <ul style="list-style-type: none"> Click the [Open] button to open the AUX terminal of the camera. Click the [Close] button to close the AUX terminal of the camera. Note AUX terminal number selection is valid only for the WJ-GXE500. For cameras other than WJ-GXE500, only Open/Close operation is possible.
Wiper operation	Wiper operation operates the washer/wiper.	Click the page switch button at the top right of the advanced camera control panel screen, to switch the panel to 2/2. Select the wiper operation from the dropdown and click the [Start] or [End] button. <ul style="list-style-type: none"> High-speed: Continuous wiping operation. (once every 4 seconds) Low-speed: Continuous wiping operation. (once every 8 seconds) Temporary control: Performs 5 wiping operations at high speed (once every 4 seconds). Washer: Performs the specified washer/wiper operation. Note <ul style="list-style-type: none"> The following operations cannot be performed while the washer is in operation. <ul style="list-style-type: none"> "Wiper" function - [Start] and [End] operations Pan, tilt, zoom, and focus control "Auto mode" - [Start] operation "Preset" - [Move] operation Washer operation setting is required on the camera side. For more information, refer to the Operating Instructions of WV-SUD638.
Home position registration	Sets the home position from the registered preset positions.	In the advanced camera control panel, register presets and click the [Set] button. On the displayed camera setup screen, click the [▲]/[▼] buttons for "Preset" and select the preset number (1 to 256) to be registered as the home position. Click the [Register] button, and then click the [OK] button on the confirmation screen. Click the [Back] button to return to the advanced camera control panel.
Auto back focus operation	The camera's auto back focus works and automatically adjusts the back focus for the subject in the center area of the screen.	Click the [Set] button on the advanced camera control panel. Click the [Execute] button in [Auto Back Focus] on the displayed camera setup screen. Click the [Back] button to return to the advanced camera control panel.

[Operation via recorder's main monitor]

Function	Function Description	Operation
Mask area setup	Sets the mask area of the camera.	<p>Click the [Set] button on the advanced camera control panel. When you click the [Start] button in [Mask area] on the displayed camera setup screen, a grid-like boundary line is displayed in the image display area, and the squares set as the mask area become white and translucent. Click a square in the image display area to switch the mask setting for that square On/Off.</p> <p>Click the [End] button to end the mask area setting and erase the lattice border.</p> <p>Click the [Back] button to return to the advanced camera control panel.</p> <p>Note</p> <p>Click the [Reset] button to clear all mask settings.</p>
Zoom/Focus adjustment	Adjusts camera zoom and focus.	<p>Click the [Set] button on the advanced camera control panel. Click the [Set] button in [Zoom/Focus adjustment] on the displayed camera setup screen. Click the [-] [x1] [+] buttons on the displayed zoom/focus adjustment screen to adjust the zoom. Also click the [Zoom in] [Reset] [Zoom out] buttons to adjust the focus.</p> <p>Click the [Back] button to return to the camera setup screen.</p>
Initial position setup	Tilts the omnidirectional camera, adjusts the vertical angle and adjusts the image cropping position horizontally.	<p>Click the [Set] button on the advanced camera control panel. Click the [Set] button in [Initial position settings] on the displayed camera setup screen.</p> <p>Adjust the position by clicking various buttons or directly on the image on the displayed initial position setting screen.</p> <p>Click the [Save settings] button to save the adjusted image position in the camera.</p> <p>Click the [Back] button to return to the camera setup screen.</p>

Event function

The recorder will take an event action when any of the following events occur.

- Terminal alarm: An event when an alarm input signal is supplied from an external device such as a door sensor to the alarm input terminal on the rear of the recorder.
- Camera site alarm: An event when an alarm (camera terminal alarm, etc.) is detected by a camera.
- Command alarm: An alarm when receiving an alarm from a PC, etc. via a network.

Action to be taken upon an event occurrence

When the recorder recognizes an event, it will take an event action according to the set action mode.

Event action mode

In the event modes shown below, the recorder takes one of the following event actions when an event occurs.

The event action mode can be configured on the setup menu. (☞ Page 46)

Recording & alarm action: Performs all event actions according to the settings. ("A" in the following table)

Recording only: Performs only recording, filing alarm logs, and moving to camera presets. ("B" in the following table)

Off: Files only alarm logs. ("C" in the following table)

A different event action will be taken depending on the selected event action mode. Refer to a system administrator for further information.

Event action	Description	Mode*1		
		A	B	C
Recording				
Start event recording*4	Recording will start according to the recording duration configured on the setup menu.	●	●	×
Define pre-event recording	Camera images recorded before an event occurs can be associated with the event and saved on the hard disk.	●	●	×
Alarm action				
Move the camera to the preset position	Move the camera to the preset position registered in advance.	●	●	×
Blink the alarm indicator	The alarm indicator on the front panel will start blinking.	○	×	×
Sound the buzzer	The buzzer will start sounding for the duration set in advance.	●	×	×
Outputs alarm signals	Output signals will be sent from the ALARM/CONTROL connector at the rear of the recorder.	●	×	×
Display event information on the main monitor*3	The event type and terminal/camera number will be displayed on the status display panel. At the same time, the alarm button turn red.	○	×	×
Display the alarm icon on a web browser*3	The alarm icon will be displayed on the event error display area of the web browser.	○	○	×
Display the alarm message on a web browser	A window that notifies of an event occurrence will be displayed on the web browser. * The alarm message displayed last has priority. To close the window, click the [x] button.	●	×	×
Record the alarm logs*2, *3	Date & time of the event and event information will be recorded in a log list.	●	●	●

[Operation via recorder's main monitor]

Event action	Description	Mode*1		
		A	B	C
Alarm action				
Send a mail that notifies of an event occurrence	An e-mail notifying of the event and its date & time (alarm mail) will be sent to registered e-mail addresses (up to 4).	●	×	×
Provide an alarm notification to a PC according to the TCP alarm notification setting	When an event occurs, a notification will be sent to a PC in accordance with the settings made under [TCP alarm notification]. (☞ Page 42, 59)	●	×	×
Notify PC of alarms according to HTTP alarm settings	When an event occurs, the PC is notified of the event according to the "HTTP alarm" settings. (☞ Page 60)	●	×	×
Display the images on a 1-screen when an alarm occurs	Display the images recorded by the camera associated with the alarm number on a 1-screen	●	×	×

- *1 ○: Takes action regardless of the setting, ●: takes action in accordance with the setting, ×: takes no action
- *2 When "On" is selected for the "Additional alarm data" setting of the camera, i-VMD type information will be displayed in the alarm log. For further information, refer to the operating instructions of the camera in use.
- *3 The extension software alarm is displayed by name (☞ page 49). Alarms notified by message IDs that are not set are displayed as "Undefined".
- *4 The extension software alarm notified by message IDs that are not set (☞ page 49) is recorded as camera site alarm.

Stop buzzer beeping

The buzzer sounding to announce an alarm or error can be stopped from the recorder's front panel.

Step 1

Press the [BUZZER STOP] button.

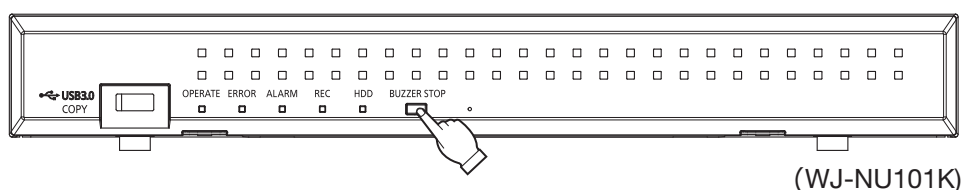

→ The buzzer will stop.

Note:

- The buzzer can also be stopped by canceling the alarm action or error action. (☞ Page 125) The [BUZZER STOP] button does not reset any of the other alarm actions.

Cancel the alarm action

The recorder will take an alarm action according to the settings configured in advance when an event occurs in the alarm mode (ALM). Information of the occurred alarm will be displayed on the status display panel of the main monitor. (☞ Page 103) To reset the alarm action, click the [Alarm] button on the status display panel, and click the alarm [Reset] button.

When an item other than "Ext." is selected for "Auto reset time" on the "Event setup" tab under "REC & event" on the setup menu [Basic setup] (☞ Page 44), the following actions will automatically be taken even if the alarm action is not canceled by clicking the alarm [Reset] button.

- The alarm indicator on the front panel will stop blinking and light steadily.
- The alarm status display on the main monitor will disappear.
- The sounding buzzer and the alarm output will stop.

Step 1

Click the [Alarm] button displayed on the main monitor, and click the alarm [Reset] button.



→ The alarm action will be canceled and the alarm indicator will go off.

Note:

- When the alarm action is canceled, the event recording will stop and return to the operational status just before the event occurred.

Cancel the error action

When an error (trouble) occurred on the recorder, the recorder will take the error action (a series of actions that notifies of the error occurrence). Information of the occurred error will be displayed on the status display panel of the main monitor. (☞ Page 103) To cancel an error action, first click the [Error] button on the status display panel and then the displayed error [Reset] button.

Note:

- When an error occurs, take remedial action by following the instructions displayed on the error log panel (☞ Page 137). The error indicator on the front of the recorder will go off when the cause of the error has been eliminated.
- When the cause of the error is resolved automatically, the following operations are performed automatically.
 - The error indicator on the front panel will stop blinking and light steadily.
 - The error status display on the main monitor will disappear.
 - The sounding buzzer and error output will stop.
- Clicking the error reset button turns off the error button and error indicator.

Record images

Live images can be recorded on the recorder. The image of 4 to 16 cameras can be recorded in the recorder.

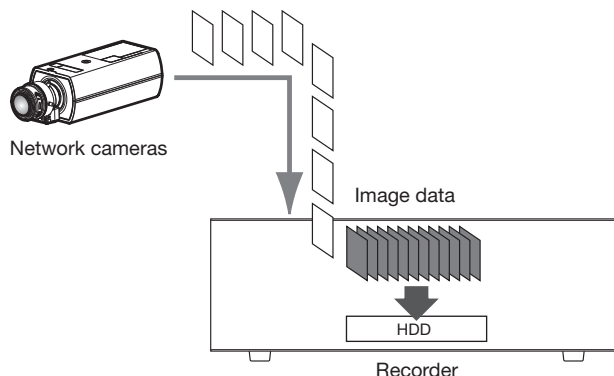

Record images (Schedule recording)

Recording can be automatically started and stopped according to a previously specified schedule. Refer to page 40 for schedule recording.

Note:

- When event recording is triggered by an alarm during the schedule recording, event recording has the higher priority. Refer to the "Recording mode and its priority" section below for further information about the priority of the recording mode.
 - To stop schedule recording, stop the recording on the setup menu. Refer to page 49 for further information.
 - In case of a network error, the image of the camera where the communication error has occurred will not be recorded. Recording starts when the network error is recovered. If the status in which the communication with the camera is disconnected recovers within around 40 seconds, it may not be recorded in the error log.
 - Schedule-recorded image data will be divided into multiple files every hour on the hour. In that moment, recording may sometimes be interrupted around for 1 second.
-

Recording mode and its priority

There are 4 recording modes. The recording modes and their priority levels are as follows.

When two or more recordings with different recording modes started simultaneously, only recording with the higher priority will start.

Recording mode	Priority
Emergency recording	1
Event recording	2
Schedule recording	3
Pre-event recording	4

Audio

The audio recording is done at the same time as the image recording. The audio recording can be set for each camera. Refer to page 43 for further information.

Note:

- The audio recording is done at the same time as the image recording. Recording of the audio only is not available.
-

Emergency recording

The recording is manually done using a switch connected to the "Emergency recording input" terminal of the "ALARM/CONTROL connector" on the back side of the recorder when the emergency occurs. For example, you can install a switch into the reception of the store and press the switch for the emergency recording when a suspicious person appears.

Important:

- The emergency recording records all images of all the connected cameras.
-

Step 1

Press the switch connected to the "Emergency recording input" terminal.

→ The emergency recording will start.

Step 2

The emergency recording will automatically be terminated when the recording time set for the emergency recording is over.

Set the recording time of emergency recording at "Recording time of emergency recording" of "REC & event" - "Advanced setup" tab on the setting menu.

Note:

- The emergency recording is the most prioritized recording mode. The emergency recording will be prioritized even if recording is being done on another recording mode.
 - Press the "Alarm reset" button to stop the recording if "Recording time of emergency recording" setting (🔍 Page 50) is "Ext."
-

Play recorded images

Display the images recorded on the recorder's hard disk on the main monitor.

Playback operation can be made while recording. Playback of images can be controlled from the operation display area or the wide view.

Refer to page 133 and following pages for playback operation.

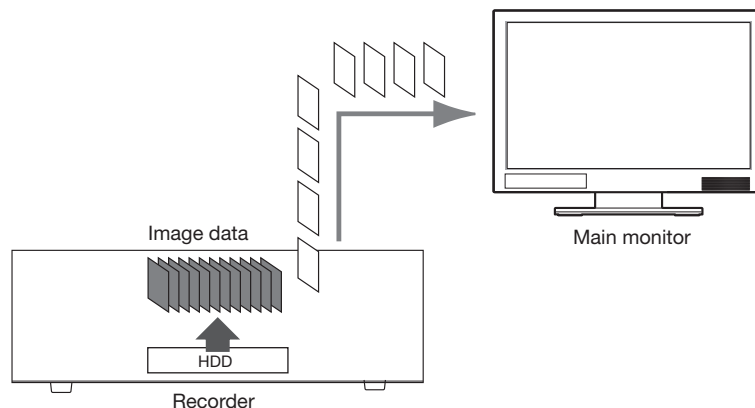

Note:

- Images can be played on 1-screen and 4-screen in the control screen.
- Images can be played back on 1-screen to 4-screen in the wide view.
- The audio of the displayed image is output on 1-screen display and the audio of the selected camera is output on multi-screen display of the control screen.
- The audio of the top-left camera on the screen is output during the wide view.
- No audio will be output when playing back in fast forward/fast reverse.
- The camera image can be changed by clicking the camera number (1 to n) during playback.
- The Multiscreen select button, digital zoom button, Mute button and OSD button remain effective during playback. Refer to "Monitor live images" (Page 107) for further information.
- When images recorded at a frame rate exceeding the following values are displayed on each segment of a multiscreen, they will be played back according to the refresh interval at the time of recording. In addition, the high-resolution recorded images cannot be displayed on a multi-screen 4K monitor. They can be displayed by fixing the HDMI output signal format to 1080p.(Page 53)

Main monitor (1080p monitor connection)

[No sub-monitor display, no re-encoding transmission]

Image capture size	HD(1280×720) FHD(1920×1080)
Multiscreen display	
1-screen, 2-screen display	(N/A)
3-screen, 4-screen display	30 ips

[Sub-monitor display or re-encoding transmission available]

Image capture size	HD(1280×720) FHD(1920×1080)	QXGA(2048×1536) ~ 4KUHD(3840×2160)
Multiscreen display		
1-screen display	(N/A)	(N/A)
2-screen display	30 ips	(N/A)
3-screen, 4-screen display	30 ips	15 ips

[Sub-monitor display and re-encoding transmission available]

Image capture size	HD(1280×720) FHD(1920×1080)	QXGA(2048×1536)	WQHD(2560×1440) ~ 9M(2992×2992)
Multiscreen display			
1-screen display	(N/A)	(N/A)	(N/A)
2-screen display	30 ips	15 ips	15 ips
3-screen, 4-screen display	30 ips	15 ips	5 ips

[Operation via recorder's main monitor]

Main monitor (4K monitor connection)

[No sub-monitor display, no re-encoding transmission]

Image capture size Multiscreen display	HD(1280×720) FHD(1920×1080)	6M(3328×1872) ~ 9M(2992×2992)
1-screen display	(N/A)	(N/A)
2-screen display	(N/A)	No display
3-screen, 4-screen display	30 ips	No display

[Sub-monitor display or re-encoding transmission available]

Image capture size Multiscreen display	HD(1280×720) FHD(1920×1080)	QXGA(2048×1536) ~ 5M(3072×1728)	6M(3328×1872) ~ 9M(2992×2992)
1-screen display	(N/A)	(N/A)	(N/A)
2-screen display	30 ips	(N/A)	No display
3-screen, 4-screen display	30 ips	15 ips	No display

[Sub-monitor display and re-encoding transmission available]

Image capture size Multiscreen display	HD(1280×720) FHD(1920×1080)	QXGA(2048×1536)	WQHD(2560×1440) ~ 5M(3072×1728)	6M(3328×1872) ~ 9M(2992×2992)
1-screen display	(N/A)	(N/A)	(N/A)	(N/A)
2-screen display	30 ips	15 ips	15 ips	No display
3-screen, 4-screen display	30 ips	15 ips	5 ips	No display

- Different values selected for resolution and frame rate will cause the data size of the playback images on the multiscreen to differ considerably, which may result in non-synchronized playback. In this case, pause and then restart playback (☞ Page 130).
- At the default, black zones will be displayed on the top and bottom of images with the aspect ratio of 16:9 when images are played back on the control screen. Refer to page 53 for the setting to enlarge the vertical size of displayed images.
- Image with an aspect ratio of 16:9 is displayed fitting into the screen when the image is played in wide view.
- When using a 4K-compatible monitor, also refer to "Restrictions when using this product" (☞ page 5).

Playback operation panel

In playback mode, operation buttons are displayed on the playback operation panel. In addition to the operation buttons, the playback operation panel displays the playback status.

Normal status (during display of live images)

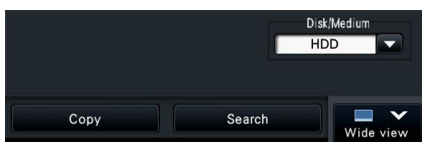
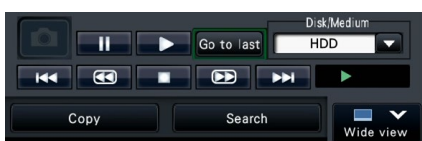
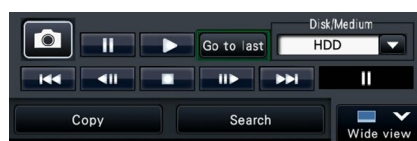

Image playback status



Playback pause status



Wide view playback status (Image playback status)

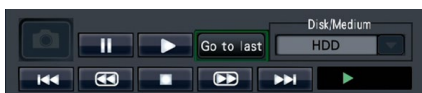

Wide view playback status (Playback pause status)



Wide view playback status (Minimized mode, image playback status)







Wide view playback status (Minimized mode, playback pause status)













Click the minimizing button  on the playback operation panel in the wide view playback status to minimize the window.

The functions of the buttons are as follows:

Function	Example	Operation
Playback button		Plays recorded images. Clicking this button while playback is paused will cancel the pause status. When the playback button is clicked during fast playback/fast reverse playback, the playback speed will be x1.
Stop button		Playback will stop and live images will be displayed when this button is clicked during playback/pause.
Pause button		Playback will be paused when this button is clicked during playback. Pause will be canceled when this button is clicked during playback/pause.
Captured image button		Saves images paused during playback on USB medium.* Clickable only while playback is paused on a 1-screen. Click to save the file. Remove the USB media after saving is complete. The image size of the captured image is not the resolution of the recording, but that of the playback.

[Operation via recorder's main monitor]

Function	Example	Operation
Next image/Previous image button	 	<p>When the next image button is clicked during pausing, the next frame is played and paused.</p> <p>When the previous image button is clicked during a pause, the previous frame is played and paused.</p> <hr/> <p>Note:</p> <ul style="list-style-type: none"> When playing H.264/H.265 images, some frames of recorded images will not be displayed. Reverse frame-by-frame playback will be performed with the refresh interval setting of the camera.
Fast forward/Fast reverse button	 	<p>Playback speed of fast playback will be changed in the following order each time the fast forward button is clicked: Step2 (Approx. 2x) → Step3 (Approx. 4x) → Step4 (Approx. 8x) → Step5 (Approx. 16x) → Step6 (Approx. 32x) → Step7 (Approx. 48x)</p> <p>Playback speed of fast reverse playback will be changed in the following order each time the fast reverse button is clicked: Step2 (Approx. 2x) → Step3 (Approx. 4x) → Step4 (Approx. 8x) → Step5 (Approx. 16x) → Step6 (Approx. 32x) → Step7 (Approx. 48x)</p> <p>The playback speed will be displayed on the playback status display.</p> <hr/> <p>Note:</p> <ul style="list-style-type: none"> When playing H.264/H.265 images, some frames of recorded images will not be displayed. Except for ×2 fast playback speed, fast playback/fast reverse playback will be performed with the refresh interval setting of the camera.
Next record/Previous record button	 	<p>Clicking the next record button will play back the next later recording.</p> <p>Clicking the previous record button will play back the next earlier recording.</p> <p>When there is no next/previous recorded image to be skipped to, the current playback will continue.</p>
Go to last button		<p>When this button is clicked, playback of the latest recorded images will start. The starting point is around 30 seconds before the date & time of the latest recorded images.</p>
Playback status display		<p>The status of the recorder such as the playback status, pause status etc. will be displayed.</p> <p>The playback speed will be displayed in fast forward/fast reverse mode.</p>
Wide view button/ Ctrl screen button	 	<p>Clicking the button during playback stops the playback and displays the live image in the wide view/control screen.</p>
Playback operation panel switch button (Displayed during playback on a full screen)		<p>The playback operation panel will be hidden when the playback operation panel is displayed. Clicking the button again will return to the original display.</p> <p>Clicking the button during the live image display will start playback and displays the playback operation panel.</p>

Play images from a designated point

It is possible to start playback from a designated date & time or the latest recorded image.

Play image recorded at a designated date & time

Start playback by designating the date & time of a recorded image on the date & time operation panel.

Date & time operation panel (normal display)

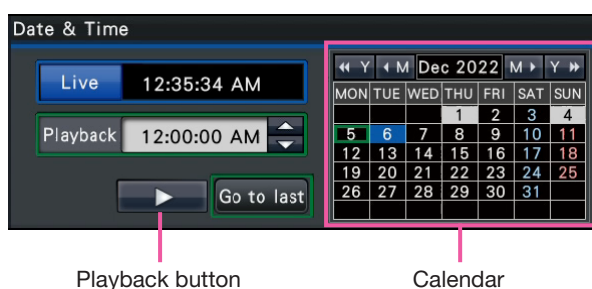

Step 1

Click the [▲]/[▼] button in the [Playback] box to set the date & time to be played.

Step 2

Select the month from the calendar in which date & time of the image to play back is included.

Click the [<<Y]/[Y>>] button to change the year and the [<M]/[M>] button to change the month.

Note:

- The current date is displayed in aqua.
- The date on which the recorded image is stored on the HDD will be displayed in white.

Step 3

Click the date & time of the image to play back from the calendar.

→ The background of the selected date turns green, and playback starts at the designated date & time.

The date & time operation panel will turn to the playback display (☞ Page 135) and the playback operation panel will be displayed on lower section of the date & time operation panel (☞ Page 130).

Note:

- Unless you want to change the date & time on the calendar, click the playback button.

Step 4

To stop playback and return to live images, click the [Live] button or the stop button on the playback operation panel.

→ Playback will stop, and live images will be displayed.

Note:

- Playback can also be stopped and live images can also be displayed by the following operations:
 - Clicking the [Live] button or [x] button on the date & time operation panel (playback display)
 - Changing the playback medium
- When there is no image stored under the entered date & time, proceed as follows:
 - When there are images recorded after the designated date & time, the oldest image recorded after the designated date & time will be played.
 - When there are no images recorded after the designated date & time, the newest image recorded before the designated date & time will be played.

Play the latest recorded image

When this button is clicked, playback of the latest recorded images will start. The starting point is around 10 seconds before the date & time of the latest recorded images.

Date & time operation panel (normal display)

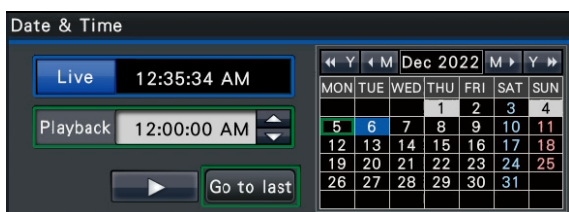

Operation panel (Wide view display)



Step 1

Click the [Go to last] button.

- Playback of the latest recorded images will start. The date & time operation panel will change to playback display (Page 135). At the same time, the playback operation panel (Page 130) is displayed at the bottom of the date & time operation panel.

Step 2

To stop playback and return to live images, click the [Live] button or the stop button on the playback operation panel.

- Playback will stop, and live images will be displayed.

Note:

- Playback can also be stopped and live images can also be displayed by the following operations:
 - Clicking the [x] button on the date & time operation panel (playback display)
 - Changing the playback medium
- When clicking the [Go to last] button while displaying images on a 4-screen, the recorded image may not be displayed depending on the timing. In this case, click the [Go to last] button again.
- The playback cannot start during the live sequence display in wide view. Click the [Go to last] button after switching the screen to those other than the live sequence display.

Playback by designating a timeline

When playback starts, the date & time operation panel will change to playback display.

This section explains how to use the timeline display to designate a playback date & time by operating the playback slider.

Date & time operation panel (playback display)

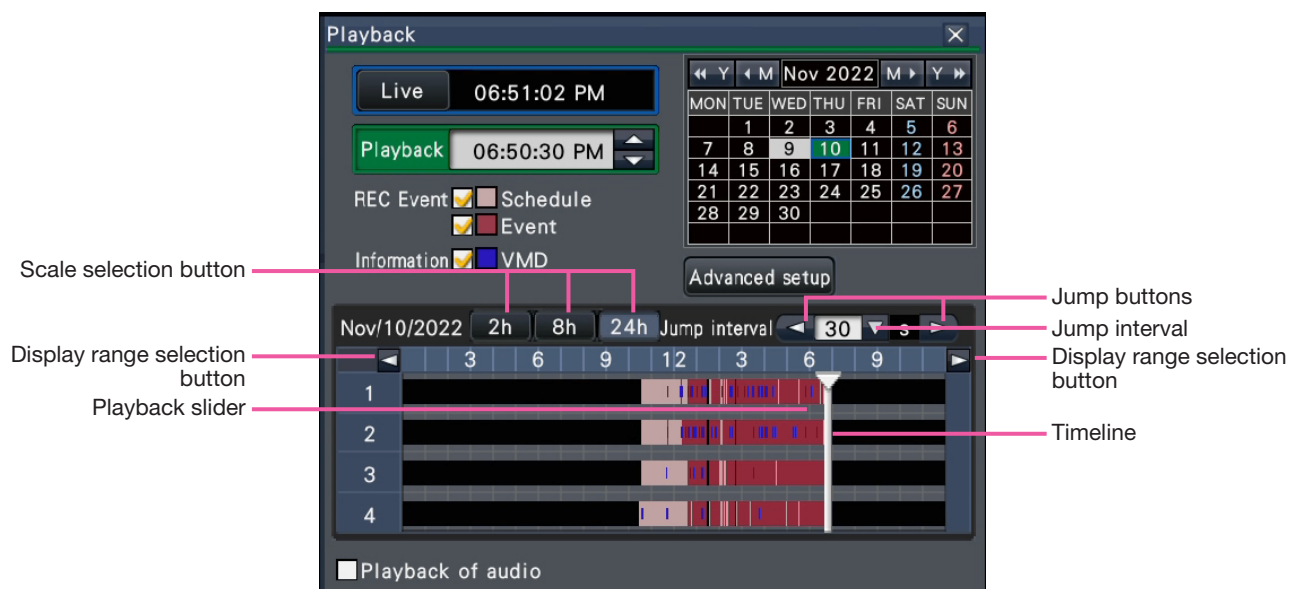

The playback display shows available recorded images and displays these on a timeline sorted by type. It is possible to change the type of recorded images displayed on the timeline, change the timeline scale, and designate the recorded image to play.

[REC Event]

Mark the checkboxes of different types of recorded images and display them on a timeline. If changes are made during playback, playback will be paused and a new search will be performed.

Schedule: Schedule-recorded images will be displayed in pink

Event: Event-recorded images will be displayed in red

[Information]

When this box is checked, the time zone recorded when the VMD function was activated (motion was detected in an image) will be displayed in blue on the timeline. (Playback will be paused.)

Periods for which no recorded images are available will be displayed in black.

Note:

- To display motion detection information, a camera that supports the function of adding motion detection information is required. For more information about this function, refer to the Operating Instructions of the camera.

[Time-saving playback]

When it is checked, the recorded image is automatically played up to 4 times faster if there is no movement in the image. Remove the check mark if you want to play the image at normal speed.

If you activate the time-saving playback (Page 53), the screen is displayed with the box always checked.

Note:

- To use the time-saving playback, a camera that supports the motion detection information addition function is required. For more information about this function, refer to the Operating Instructions of the camera. (When motion detection information is set to "Off" or recorded by our or Panasonic cameras that do not support motion detection information setting, the camera will playback at high speed regardless of whether there is motion or not.)

[Operation via recorder's main monitor]

- The time-saving playback only functions when the image is played back at the actual size on 1-screen ~ 4-screen.
- When the time-saving playback functions in the fast playback mode,  is displayed. During this time, no audio is output.
- When an image is played with a recorded time close to the current time, fast playback is not available.
- When the image capture size and the frame rate of the recorded image are high, the fast playback may not be available. In addition, the playback speed of each image may not be the same during multiscreen playback depending on the setting values of the image capture size and the frame rate of each recorded image.

[Advanced setup] button

Display the advanced setup panel and change event types and other information displayed on the timeline. Playback will be paused.

[Scale selection] button

Select a timeline display covering 2 hours (2 h), 8 hours (8 h) or 24 hours (24 h).

[Display range selection] button

The timeline will be displayed in accordance with the setting of the scale selection button.

[Playback slider]

Displays the time during playback. Drag and drop the playback slider to a desired time on the timeline to start playback from that time.

Note:

- The playback slider may not soon move to the desired position.
-

[Jump interval]/[Jump] buttons

Move the playback point by a given amount of time and play back from that point. Clicking the [<] / [>] buttons will move the playback point by the amount of time specified under [Jump interval].

Available ranges: 10 s/ 15 s/ 30 s/ 60 s/ 180 s/ 300 s

[Playback of audio]

This item is displayed when the recorder is set up to lock in a camera with audio output. If this checkbox is marked, the audio associated with the displayed image will be output. (☞ Page 55)

Change event types and other information displayed on the timeline

[Advanced setup]

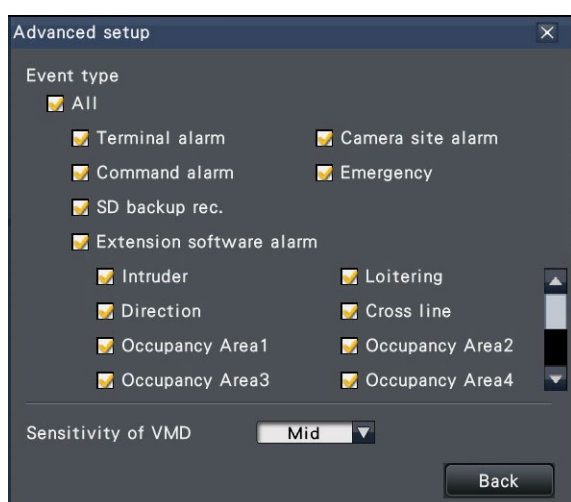

[Event type]

Set event types to be displayed on the timeline. To display event-recorded images on a timeline, mark their checkboxes.

Refer to page 123 for further information about each alarm.

Note:

- User-defined 1 to user-defined 8 are displayed when the message ID of the extension software alarm (☞ page 49) is set.
-

[Sensitivity of VMD]

Set the sensitivity for the motion detection displayed on the timeline. Sensitivity increases in the steps shown below.

Low → Mid → High → All

[Back] button/[x] button

Click this button to return to the date & time operation panel (playback display).

Search and play

Search a desired recorded image and play it. There are the following 3 searching methods.

- Play images selected from alarm and error logs (Log search)
- Display thumbnail screen and play back (Thumbnail search)
- Search and play images recorded triggered by the motion detection of the camera (VMD search)

Play images selected from logs (Log search)

Display the alarm log list or error log list, and click a date & time to play the corresponding recorded images.

Note:

- The corresponding recorded data that is displayed in the selected log list cannot be played if the data has already been overwritten or erased.
- The images recorded by the camera's motion detection alarm can be selected and played back from the alarm history.

Step 1

Click the [Alarm] button or [Error] button on the status display panel.

→ The corresponding [Log] buttons will be displayed.



Step 2

Click the [Log] button.

→ The alarm log panel or error log panel will be displayed. It is possible to switch between list pages by clicking the [Previous]/[Next] buttons.

No.	Date & Time	Log
1	Dec/01/2022 07:57:24 AM	Camera site(Motion Det.):Cam.1
2	Dec/01/2022 07:51:52 AM	Camera site(Motion Det.):Cam.1
3	Dec/01/2022 05:46:58 AM	Camera site(Motion Det.):Cam.9
4	Dec/01/2022 05:46:33 AM	Camera site(Motion Det.):Cam.9
5	Dec/01/2022 05:46:10 AM	Camera site(Motion Det.):Cam.9
6	Dec/01/2022 05:44:48 AM	Camera site(Motion Det.):Cam.9
7	Dec/01/2022 05:44:31 AM	Camera site(Motion Det.):Cam.9
8	Dec/01/2022 05:43:10 AM	Camera site(Motion Det.):Cam.9
9	Dec/01/2022 05:39:56 AM	Camera site(Motion Det.):Cam.9
10	Dec/01/2022 05:39:19 AM	Camera site(Motion Det.):Cam.9
11	Dec/01/2022 05:39:09 AM	Camera site(Motion Det.):Cam.9
12	Dec/01/2022 05:37:43 AM	Camera site(Motion Det.):Cam.9
13	Dec/01/2022 05:36:57 AM	Camera site(Motion Det.):Cam.9

No.	Date & Time	Log
1	28/Dec/2022 11:31:53	Thermal error:MAIN
2	27/Dec/2022 11:39:16	Communication recovered:Cam.1
3	27/Dec/2022 11:39:16	Communication recovered:Cam.2
4	27/Dec/2022 11:39:16	Communication recovered:Cam.3
5	27/Dec/2022 11:39:16	Communication recovered:Cam.4
6	27/Dec/2022 11:38:03	Communication error:Cam.3
7	27/Dec/2022 11:38:03	Communication error:Cam.1
8	27/Dec/2022 11:38:03	Communication error:Cam.4
9	27/Dec/2022 11:38:03	Communication error:Cam.2
10	27/Dec/2022 11:29:02	Communication error:Cam.4

▲ Previous Total:978 Next ▼

Remedy
The internal temperature is extremely high. Do not block the ventilation openings in the cover to prevent this product

Note:

- Up to 1000 error logs are saved. When more than 1000 logs are filed, the older logs will be overwritten by the newer logs. In this case, the oldest log is the first to be overwritten.

Step 3

Select the line with the desired list, and click the playback button on the playback operation panel. (Page 130)

→ Playback will start from a point approx. 5 seconds before the date & time selected.

Note:

- Up to 1000 alarm logs are saved. When more than 1000 logs are filed, the older logs will be overwritten by the newer logs. In this case, the oldest log is the first to be overwritten.

Note:

- Playback can also be started by double-clicking the desired date & time line.
- To start playback from the beginning of the pre-event recording when the "Pre-event duration" setting is longer than 5 seconds, click the playback button, and then click the previous record button.
- If no recorded image is available for 5 seconds from the date & time, image will be played from the date & time.

Step 4

To stop playback and return to live images, click the stop button on the playback operation panel.

(Page 130)

→ Playback will stop, and live images will be displayed.

Note:

- The following operation can also be used to stop playback and display live images.
 - Click the [x] button on the date & time operation panel (playback display)
 - Click the [Current time] button on the date & time operation panel (playback display)
 - Change the playback media

Display thumbnail screen and play back (Thumbnail search)

Search a thumbnail from the recorded images and play back.

Select an image from the thumbnail screen and play back the image.

Important:

- Thumbnail Search cannot be used when using a sub-monitor or during re-encoding transmission.

Step 1

Click the [Search] button of the playback operation panel.

→ The thumbnail search screen will be displayed.

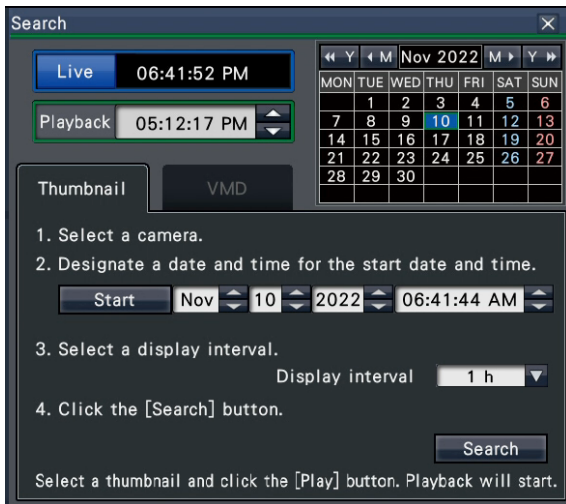

Step 2

Select a camera that you want to search on the camera number panel.

Step 3

Designate a date and time for the start date and time (Start).

Set the "Start" using the [▲]/[▼] buttons of the date and time.

Step 4

Assign the display interval of thumbnails. Displays thumbnails in accordance with the display interval by searching them from the recorded images.

Display interval: 1 min, 5 min, 10 min, 15 min, 30 min, 1 h, 2 h

Step 5

Click the [Search] button.

→ Searches thumbnails at every display interval from the assigned starting date and time and displays them on the image display area. Up to 4 thumbnails can be displayed. The [Previous]/[Next] buttons can switch thumbnails.

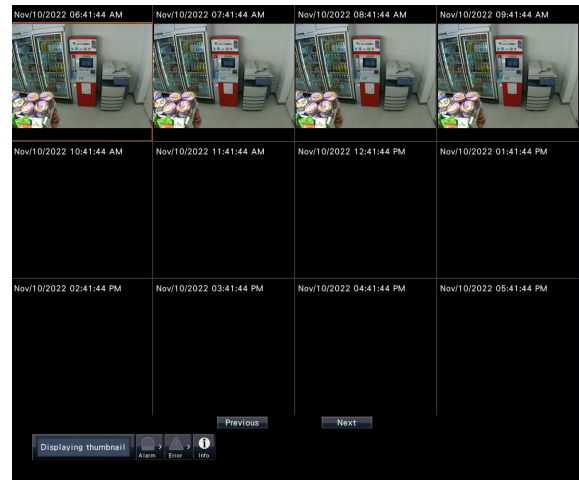

Note:

- It may take time to display all thumbnails.
- The date and time display until thumbnails are displayed is a provisional date and time calculated from the starting date and time and the display interval. Once thumbnails are displayed, the date and time will be updated to the actual date and time of the thumbnails.
- If the recorded image is not found at the assigned date and time, the thumbnail after the assigned date and time will be displayed.

[Operation via recorder's main monitor]

Step 6

Click a thumbnail that you want to play and then click the playback button on the playback operation panel.

→ Starts playback from the date and time of the selected thumbnail.

Note:

- You can start the playback by double-clicking a thumbnail that you want to play back.

Step 7

To stop playback and return to live images, click the stop button on the playback operation panel.

→ Playback will stop, and live images will be displayed.

Note:

- The following operation can also be used to stop playback and display live images.
 - Click the [x] button on the date & time operation panel (playback display)
 - Click the [Current time] button on the date & time operation panel (playback display)
 - Change the playback media

Search and play recorded images triggered by motion detection (VMD search)

Search images recorded with a camera supporting the VMD search function by the date motion was detected and play them. Click a date & time on the result list to play corresponding recorded images.

Important:

- To perform the motion detection search, a camera that supports the motion detection information addition function is required. For more information about this function, refer to the Operating Instructions of the camera.

Step 1

Click [Search] button on the playback operation panel and click [VMD] tab.

→ The VMD search panel is displayed.

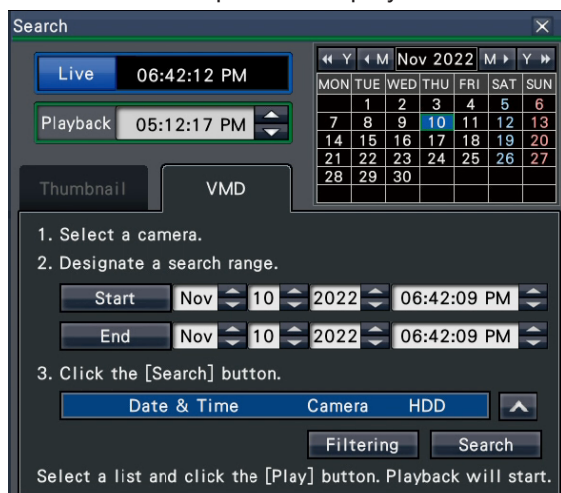

Step 2

Select a camera that you want to search on the camera number panel.

Step 3

Designate the time range to search.

Set the year, month, day and time of the start and end point by clicking the respective [▲]/[▼] buttons.

Note:

- It is also possible to set the start point and end point of the search range by clicking the [Start]/[End] buttons after selecting the desired time in the [Playback] box and clicking the desired date on the calendar.

[Operation via recorder's main monitor]

Step 4

Click the [Search] button.

- This will run a VMD search within the designated search range and display a list of results as follows. It is possible to switch between list pages by clicking the [Previous]/[Next] buttons.

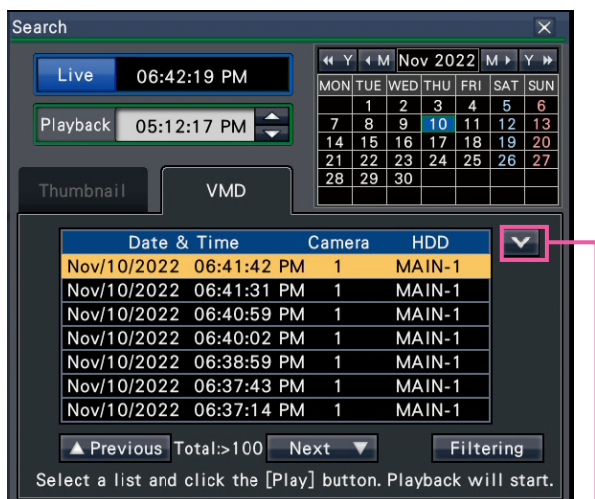

Change list size button

[Change list size] button

Displays/Hides the list.

Note:

- Up to 100 logs are displayed in the list. When more than 100 logs are filed in the search result, "> 100" will be displayed.
- The VMD search function searches the entire camera image by default. To designate a search area, click [Filtering] button and set the search area on the filtering panel. (Page 141)
- It may take some time until the search results are displayed.

Step 5

Select the line with the desired list, and click the playback button on the playback operation panel.

(Page 130)

- Playback will start from the date & time selected.

Note:

- Playback can also be started by double-clicking the desired date & time line.

Step 6

To stop playback and return to live images, click the stop button on the playback operation panel. Playback will stop, and live images will be displayed.

Note:

- The following operations can also be used to stop playback and display live images.
 - Click the [x] button on the date & time operation panel (playback display)
 - Click the [Current time] button on the date & time operation panel (playback display)
 - Change the playback media

Set up VMD areas, etc. [Filtering]

Assign the search area, setup the motion detection area in the image and masking period.

Step 1

Click [Search] button on the playback operation panel and click [VMD] tab. (Page 139)

Step 2

Select a camera that you want to search on the camera number panel.

Step 3

Click the [Filtering] button.

→ The filtering panel will be displayed.

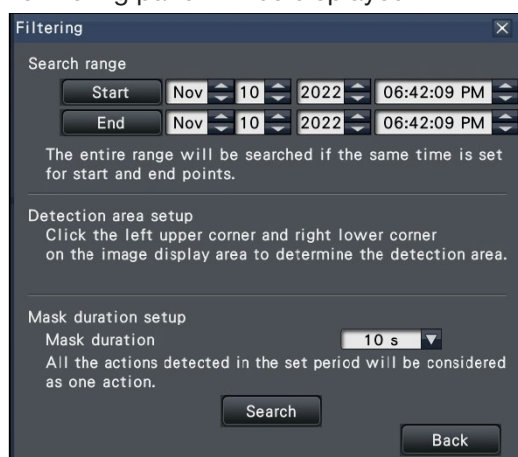

[Designate the search range]

Designate the time range to search.

→ Set the "Start" and "End" by clicking [▲]/[▼] button of the date and time respectively.

[Detection area setup]

Click 2 points of the upper left and lower right to create a square to be set as the area on the displayed image.

→ The set area will be displayed in gray, and the area will become subject to be searched for motion detection.



Note:

- As the detection areas will be set up to match the image display area divided into 16×16 segments, the top left and bottom right detection areas may not be exactly as designated.
- It is impossible to delete the detection area that has been set. To change the area, re-set the detection area.

[Mask duration setup]

If VMD search takes too much time or the search produces too many results, set a mask duration to reduce the search frequency. When mask duration is set, no motion detection will be performed from the time motion is detected to the time mask duration is set.

To set, click the [▼] button next to [Mask duration setup] on the advances setup panel.

Mask duration: 1 s/ 5 s/ 10 s/ 30 s/ 1 min/ 5 min/ 10 min

Default: 10 s

Step 4

Clicking the [Search] button will start searching by the assigned conditions.

Copy recorded images

Copy the recorded image on the recorder to an external storage device (external HDD, USB memory stick). In this document, these are sometimes referred to as media.

Personal information may be included in copied images. Take an extra caution to handle and manage the medium used for copying to prevent from information leakage.

It is impossible to copy recorded images when the recorder is in the following statuses.

- When the copy window is being opened by other user via a network
- When the medium (external storage device) is being selected by another user via network
- When the medium (external storage device) is selected as the playback medium

The copied recorded images can be played on the recorder or on a PC using the dedicated viewer software. The viewer software will automatically be copied on the storage medium (external storage device) on which recorded images are copied. Refer to page 179 for how to operate the viewer software. Refer to page 146 for how to play the copied recorded images on the recorder.

The original (n3r: video, n3a: audio) file or MP4 file copied on the external storage device can be played back on the recorder.

Note:

- When copying images onto an external storage device, format the device first before starting copying.
- Required time for copying varies depending on the data size to be copied. It will take longer time to copy recorded images when they were recorded with a larger image capture size, in a higher quality or at a higher frame rate even though the same number of cameras and the same duration are set for copying.
- Copying of recorded images may sometimes be performed incorrectly when there exist 2 or more images recorded at the same date & time resulting in change of the date & time setting or the auto time adjustment function.
- In the following cases, the copying currently being performed will stop.
 - When any of the settings of the recorder is changed
 - When a user who started manual copy logged out (It will take around 90 seconds until copying is stopped after the web browser is closed.)
 - When the original data (source for copying) is lost (overwritten or malfunction of the hard disk drive)

Step 1

Connect an external storage device to the copy port [COPY] of the recorder.

Step 2

Click the [Copy] button on the operation panel of the main monitor.

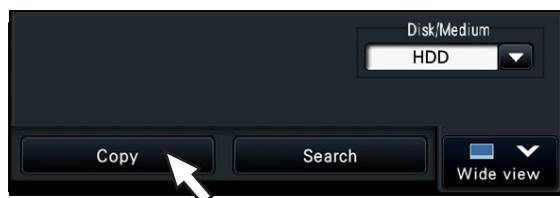

→ The copy panel will be displayed (if in playback mode, playback will be paused).

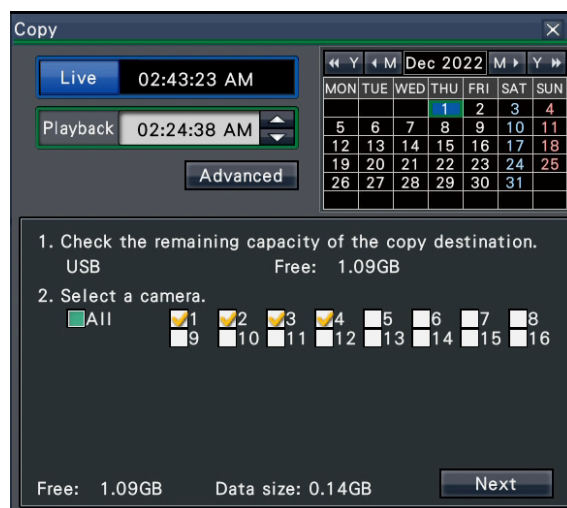

Note:

- The copy panel cannot be displayed in the web browser when it has already been opened by another user. When copying is already underway, the copying window will be displayed.

[Operation via recorder's main monitor]

Step 3

Set copying conditions following the instructions on the screen.

Clicking [Next]/[Back] button switches the page. Click the [x] button to close the window.

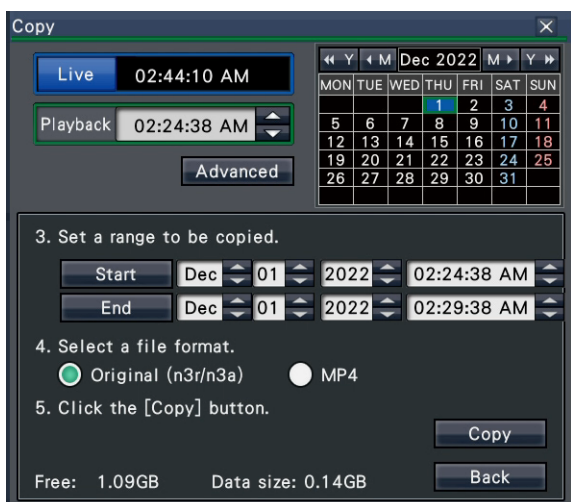

Item	Description
Camera selection	Check the number of the camera whose recorded data is to be copied. Checking [All] will copy the recorded data of all cameras.
Date & Time range	Specify times and dates to define the range for copying recorded data. Set the year, month, date & time of the start point and end point. It is also possible to set the start point and end point of the filter range by clicking the [Start]/[End] buttons after clicking the desired date on the calendar and then selecting the desired time in the [Playback] box.
File format selection	Check the file format (Original (n3r/n3a), MP4) of the recorded image to be copied.

Free:

The remaining space of the storage medium will be displayed.

Data size:

The total volume of all recorded images to be copied (including the viewer software) will be displayed.

* Indicated as *.* GB while the data volume is being calculated.

* When the calculated value exceeds the remaining volume during calculation, ">" will be indicated in front of the data size, and the calculation stops.

* If ">" is indicated even though the calculated value is smaller than the remaining volume, it means that over 10000 of recorded data exists as target.

Note:

- Images recorded in H.264 or H.265 can be copied in MP4 format. If audio is recorded in AAC-LC, the image is copied in MP4 format with audio.
- Copying and downloading (Page 175) in MP4 format are available for up to 2 users at the same time.
- To attach a code for alteration detection, click the [Advanced] button. On the advanced setup window, set [Attach the alteration detection code] to "On".

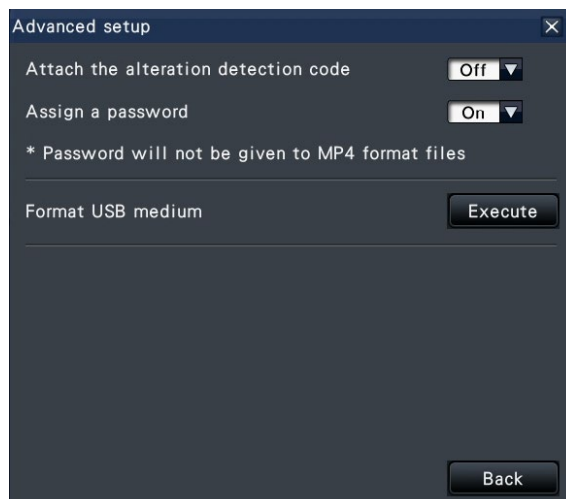

- When you assign a password to the data that you will copy, click the [Advanced setup] button and set "On" for [Assign a password] on the displayed advanced setup screen.
- Clicking the [Back] button will return to the copy panel.

Step 4

Click the [Copy] button on the copy panel.

→ If [Assign a password] is set to "On", the password entry screen will be displayed. Otherwise proceed to Step 6.



Step 5

Enter the password using on-screen keyboard, and then click the [Next] button.

- Enter 5 to 8 alphanumeric characters for a password.
 - To confirm the password, enter the same password again into the "Retype password" column.
 - To save the entered password, check "Memorize password temporarily". The next time data is copied, the password entry window will open with the password already filled in. The password will be retained in memory until the power of the recorder is turned off.
- The copy start confirmation window will be displayed.

Step 6

Click the [OK] button in the copy start confirmation window.

- Switches to the copying window and displays copying progress.

Important:

- Do not disconnect the external storage device when copying is being performed. Otherwise the data stored on the external storage device could be lost.
- If the copy destination lacks sufficient remaining storage capacity, copying will continue until the medium is full. Use a medium with sufficient storage capacity to avoid left over data that is not copied.
- Copying will be performed in the following order: Viewer Software → Images → Audio Depending on the designated time range for copying and the remaining space of the storage medium, images and audio may not be copied.
- Clicking the [Copy] button during the copying process will display the copying window. Clicking the [Cancel] button will display the copy cancel confirmation window. Copying continues while the copy cancel confirmation window is displayed.
- Do not turn off the power of the recorder while copy is in progress. If the power is turned off while copying, the storage media copied on will become unusable.
- Recorded images (data) of up to 1 million can be copied onto the external storage device. However, it is impossible to copy any more data exceeding these limits even when there is a sufficient remaining capacity.

- Due to characteristics of the file system, the copying time becomes longer as the number of recording data copied to the external storage device at one time increases. To copy a massive number of files, keep the number of files to handle at one time less than 10000. And every time the copy is finished, it is recommended to disconnect the memory device and connect it again.
- The progress of the copy is calculated based on the size displayed as "Data size". If copying more than 10000 files, correct value will not be displayed.

Note:

- Usage time varies depending on the capacity of the external storage device or the recording content. Retry again later if you fail in operation.
-

Step 7

Once the copying process is completed, the copy complete window will be displayed. Click the "Close" button and remove the external storage device.

Format USB medium

USB medium recognizable by the recorder can be formatted by the recorder.

Important:

- Formatting will delete all data and setup information stored on a USB medium. Image data once deleted cannot be restored.
 - The file systems recognizable by the recorder are exFAT, FAT (FAT 16) and FAT 32.
 - USB media with a file system that cannot be recognized by this product, such as NTFS, cannot be formatted.
 - This recorder can format in FAT (FAT 16), FAT 32 and exFAT according to the capacity of the USB medium.
-

Step 1

Click the [Copy] button on the operation panel of the main monitor. (☞ Page 142)

→ The copy panel will be displayed.

Step 2

Click the [Advanced] button. (☞ Page 142)

→ The setup menu (advanced) will be displayed.

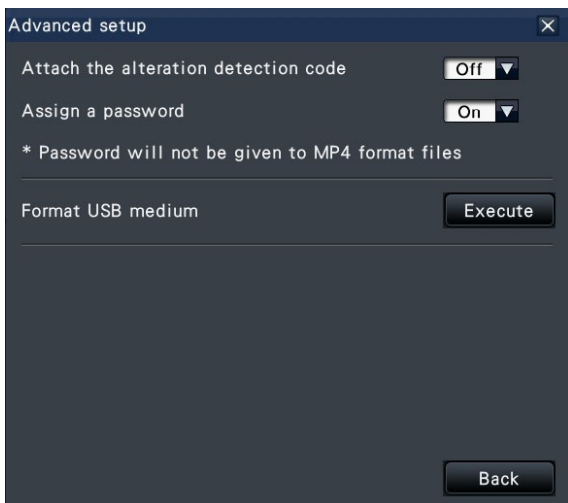

Step 3

Click the [Execute] button for "Format USB medium".

→ The confirmation window will be displayed.

Step 4

Click the [OK] button.

→ Formatting of the USB medium will start, and a window indicating that formatting is in progress will be displayed.

When formatting is completed, the format completion window will be displayed.

Important:

- Do not turn off the power of the recorder while formatting is in progress.
-

Play back copied images with this recorder

Display recording images copied to the external storage device (copy data) on the list, select among them and playback. It is possible to search for copied data using filters.

Important:

- The n3r (video)/n3a (audio) file or MP4 file copied to the external storage device can be played back.

Step 1

Insert the external storage device to which the recording data is copied into the recorder.

Step 2

Select [USB] of the "Disk/Medium" on the playback operation panel.

→ The media playback panel will be displayed. Up to 10000 logs are displayed in the list. When more than 10000 logs are filed in the search result, "> 10000" will be displayed.

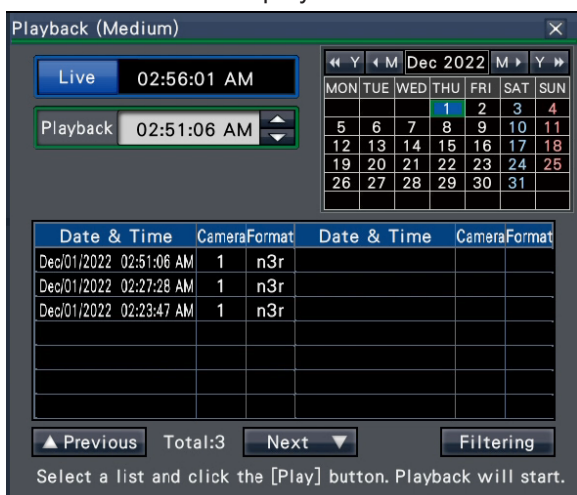

Note:

- When copying large amounts of data, more time is needed to display the list.

Step 3

Click [Filtering] button to filter the number of the copied data displayed on the list. The filtering panel will be displayed.

To play back without filtering, proceed to Step 5.

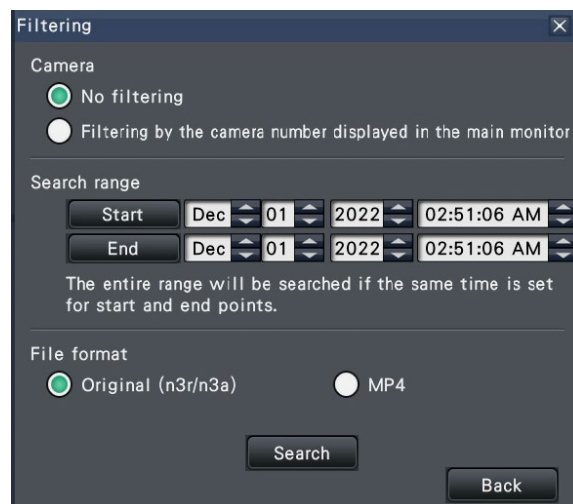

Filtering by camera

Select "Filtering by displaying camera". Filtering will be applied to the camera whose image is displayed.

Filter by designating date & time

Specify the filter range by designating a date & time. To specify the filter range, set the year, month, day and time of the start and end point by clicking the respective [▲]/[▼] buttons.

File format

Select the format for filtering.

Note:

- It is also possible to set the start point and end point of the filter range by clicking the [Start]/[End] buttons after clicking the desired date on the calendar and then selecting the desired time in the [Playback] box at Step 2.

Step 4

Click the [Search] button.

→ A list of search results for the specified filter criteria is displayed. It is possible to switch between list pages by clicking the [Previous]/[Next] buttons.

Note:

- When copying large amounts of data, more time is needed to display the list.

Step 5

Select the line with the desired date & time, and click the playback button on the playback operation panel.

→ Playback will start from the date & time selected.

If the multiscreen was displayed, it will change to the 1-screen.

Note:

- Playback can also be started by double-clicking the desired date & time line.
- If the selected copied data is password protected, the password entry screen will be displayed. Enter the assigned password using on-screen keyboard, and click the [OK] button. If the wrong password is entered, the copied data cannot be played back.
- Usage time varies depending on the capacity of the external storage device or the recording content. Retry again later if you fail in operation.
- If you play multiple data files continuously, the audio may not be synchronized. In this case, pause and then restart playback.

Step 6

To stop playback and return to live images, click the stop button on the playback operation panel.

→ Playback will stop, and live images will be displayed.

Note:

- Playback can also be stopped and live images can also be displayed by the following operations:
 - Clicking the [x] button on the media playback panel.
 - Clicking the [Live] button on the date & time operation panel (playback display)
 - Changing the playback medium

List of operation items

The following "Top items" mainly shows operation and "Middle items", "Bottom items" and "Details" mainly show each operation menu of the main monitor and the browser.

○, △ and × indicate operable, partially limited, inoperable respectively.

Top items	Middle items	Bottom items	Details	Remarks	Main body	Browser	
Live image display	Main monitor	Ctrl screen	Image display area		○	○	
			Status display panel		○	○	
			Operation panel		○	○	
			[Wide view] button		○	○	
		Wide view display	Image display area		○	○	
			Status display panel		○	×	
			Operation panel		○	×	
			[Ctrl screen] button		○	×	
	Sub monitor	–	–	* The setup of the sub monitor is possible, but the actual image on the sub monitor cannot be displayed on the browser.	○	×	
	About the operation panel	Multiscreen buttons	–			○	×
		Digital zoom buttons	–			○	×
		Mute button	–			○	○
		Fisheye correction (1PTZ/4PTZ) button	–			○	×
		Change the camera display position in the wide view screen	–			○	×
		Digital zooming in the wide view screen	–		* It is operable by the mouse wheel only in the 1-screen for the recorder.	○	×
Camera operation	Camera operation	Camera operation	–	* The recorder can be operated with 1-screen/4-screen display.	○	○	
		Panning and tilting	PT button		○	○	
			PT pad		×	○	
			Click centering		○	×	
		Zoom	[Zoom] button		○	○	
			Mouse wheel zooming		○	×	
			Drug zooming		○	×	
		Focus	–		○	○	
		Brightness	–		○	○	
		Auto mode	–		○	○	
		Preset position	Register camera preset positions		○	○	
			Move camera preset positions		○	○	
	Move to home position			○	○		
	[Enable camera control with mouse] checkbox	–		* Since this is a switch of the mouse operation on the image of the HDMI monitor, it cannot be set from the browser.	○	×	
	Camera setup	Register home position	–		○	×	
Execute auto back focus		–		○	×		
Set up mask areas		–		○	×		
Zoom/Focus adjustment		–		○	×		
Initial position setup		–		* The settings of Inclination, vertical angle adjustment and horizontal adjustment of the image cut area of the fisheye camera is available.	○	×	

[Operation via recorder's main monitor]

Top items	Middle items	Bottom items	Details	Remarks	Main body	Browser	
Alarm action	Action to be taken upon an event occurrence	–	–		<input type="radio"/>	<input type="radio"/>	
	Stop buzzer only.	–	–		<input type="radio"/>	<input checked="" type="checkbox"/>	
	Cancel the alarm action	–	–		<input type="radio"/>	<input type="radio"/>	
	Cancel the error action	–	–		<input type="radio"/>	<input type="radio"/>	
	Display alarm log				<input type="radio"/>	<input type="radio"/>	
	Display error log				<input type="radio"/>	<input type="radio"/>	
Recording	Record images (schedule recording)	–	–		<input type="radio"/>	<input type="radio"/>	
Search/ Playback	Play recorded images	Playback operation panel	Playback		<input type="radio"/>	<input type="radio"/>	
			Stop		<input type="radio"/>	<input type="radio"/>	
			Pause		<input type="radio"/>	<input type="radio"/>	
			Next image/ Prev image		<input type="radio"/>	<input type="radio"/>	
			Fast forwarding/reverse fast forwarding		<input type="radio"/>	<input type="radio"/>	
			Next record/ Prev record		<input type="radio"/>	<input type="radio"/>	
			Go to last		<input type="radio"/>	<input type="radio"/>	
			Jump playback		<input type="radio"/>	<input checked="" type="checkbox"/>	
			Captured image		<input type="radio"/>	<input checked="" type="checkbox"/>	
	Playback status display		<input type="radio"/>	<input type="radio"/>			
	Wide view display	–		<input type="radio"/>	<input type="radio"/>		
	Select medium	–		<input type="radio"/>	<input type="radio"/>		
	Playback medium	–		<input type="radio"/>	<input checked="" type="checkbox"/>		
	Search and play	Play image recorded at a designated date & time	–			<input type="radio"/>	<input type="radio"/>
		Play the latest recorded image	–			<input type="radio"/>	<input type="radio"/>
Playback by designating a timeline		–		* The timeline is not displayed on the browser. Play back recorded images from the recording event list.	<input type="radio"/>	<input checked="" type="checkbox"/>	
Play back recorded images by designating in REC & event list		–			<input checked="" type="checkbox"/>	<input type="radio"/>	
Play images selected from alarm and error logs (Log search)					<input type="radio"/>	<input type="radio"/>	
Search and play recorded images triggered by motion detection (VMD search)		–			<input type="radio"/>	<input checked="" type="checkbox"/>	
Play back recorded image by designating a thumbnail		–			<input type="radio"/>	<input checked="" type="checkbox"/>	

[Operation via recorder's main monitor]

Top items	Middle items	Bottom items	Details	Remarks	Main body	Browser
Copy/ Download	Copy	–	–	* The viewer software is copied together with the recorded image.	○	○
	Format USB medium	–	–		○	×
	Download data (to PC)			* Only proprietary formats (n3r/n3a) can be downloaded.	×	△
	Download viewer (to PC)				×	○

Configure the network settings

The recorder can be operated using a mouse or from a web browser on a PC (excluding certain functions and settings). On the following pages, operation from a web browser, setting up the PC and related matters will be described.

When operating the recorder using a web browser, it is necessary in advance to configure the network settings of the recorder and a PC.

When the network settings of the PC are as follows, it is unnecessary to configure the settings. It is possible to configure the settings and operate the recorder using a web browser after completing the connection.

IP address: 192.168.0.2 - 192.168.0.249, 192.168.0.251 - 192.168.0.254

Subnet mask: 255.255.255.0

Default gateway: 192.168.0.1

When the settings are configured differently from the above, configure the network settings of the recorder or a PC.

Configure the network settings of the recorder

The network settings of the recorder can be configured on the [Basic] tab of the "Network" page under the setup menu [Advanced setup].

Refer to the chapter relating to the [Basic] tab of "Network" of the setup menu on page 56 for how to operate.

Configure the network settings of the PC

The TCP/IP setting of the PC shall be changed to conform to the settings of the recorder. When using the recorder with the default (IP address: 192.168.0.250), set the IP address of the PC to "192.168.0.xxx (a number from 2 to 254 except 250 (this recorder) and camera IP address).

The settings described in these operating instructions are based on the standard settings for Windows 7. Refer to the operating instructions of the respective OS for further information.

Step 1

Click "Control Panel" on the start menu.

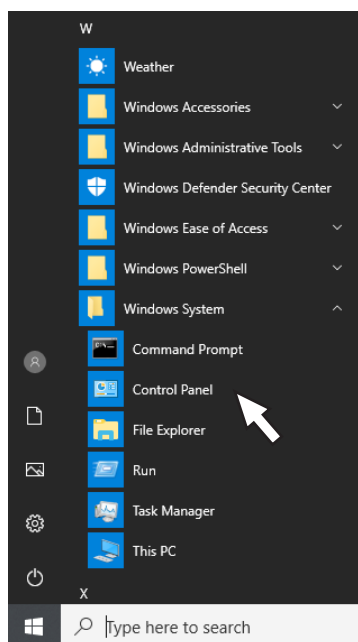

→ "Control panel" will be displayed.

Important:

- Log in to the PC as an administrator.

[Setup Network]

Step 2

Click "View network status and tasks".

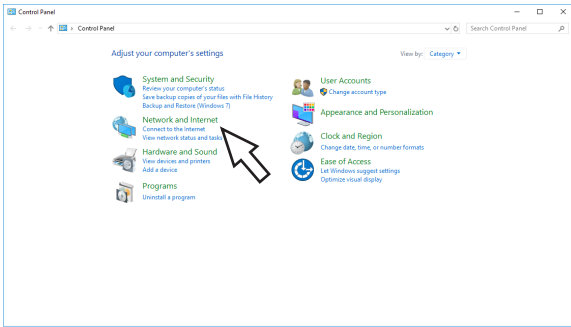

→ The "Network and Sharing Center" window will be displayed.

Step 3

Click "Local Area Connection".

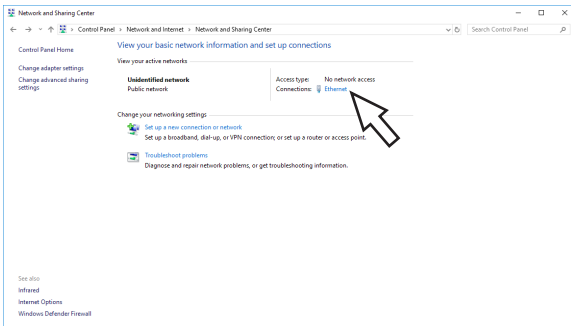

→ The "Local Area Connection Status" window will be displayed.

Step 4

Click [Properties]

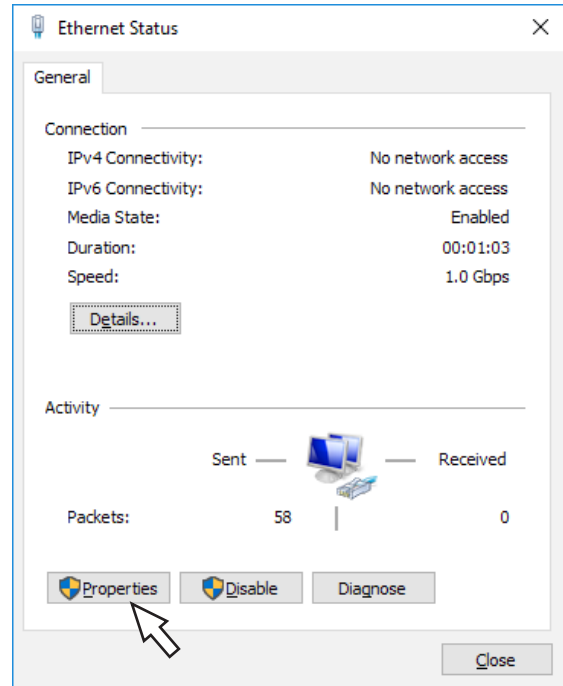

→ The "Local Area Connection Properties" window will be displayed.

Step 5

Click "Internet Protocol Version 4 (TCP/IPv4)", and then [Properties].

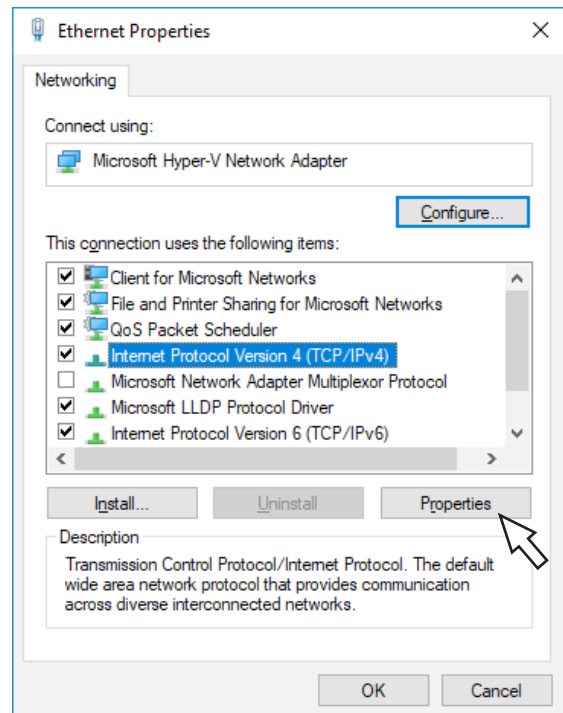

→ The "Internet Protocol Version 4 (TCP/IPv4) Properties" window will be displayed.

Step 6

Select [Use the following IP address] and set "IP address" and "Subnet mask" as follows:

- IP address: 192.168.0.9
- Subnet mask: 255.255.255.0

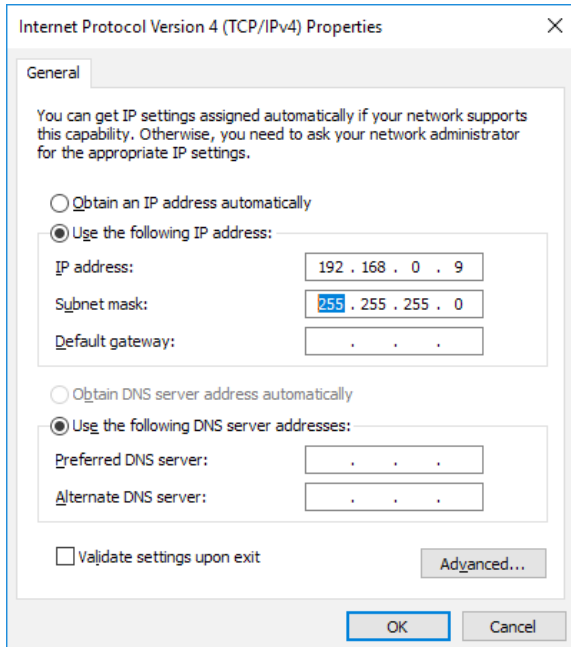

Depending on the network configuration, it is necessary to configure "Default gateway". Contact the system administrator for further information about the settings.

Step 7

Click the [OK] button and close the window.

Network security of the recorder

The security function of the recorder

① Access restriction by the user authentication

It is possible to restrict users to access the recorder by selecting "On" for "User authentication". (☞ Page 63)

② Access restriction by changing the HTTP port number

By changing the HTTP port number, it is possible to prevent illegal access such as a port scanning, etc. (☞ Page 57)

Important:

- Design and enhance security countermeasures to prevent leakage of information such as image data, authentication information (user name and password), alarm mail information, etc. Perform the countermeasure such as the access restriction using the user.
 - After the unit is accessed by the administrator, make sure to close the web browser for added security.
 - Change the administrator password periodically for added security.
-

Enhance network security

You can encrypt the communication between the recorder and camera and enhance the network security. In addition, network security can be enhanced by the following measures.

It is possible to enhance the network security by dividing the subnet using a router to authenticate users twice (by the recorder and by the router). When connecting the recorder to an unsecured network, secure the network connection by installing a VPN (Virtual Private Network) device, etc. between the recorder and the host PC.

Important:

- The settings for the network security vary depending on the network to which the recorder is to be connected such as an intranet or Internet service provider. Refer to a network administrator for further information about the network security.
-

[Connection example]

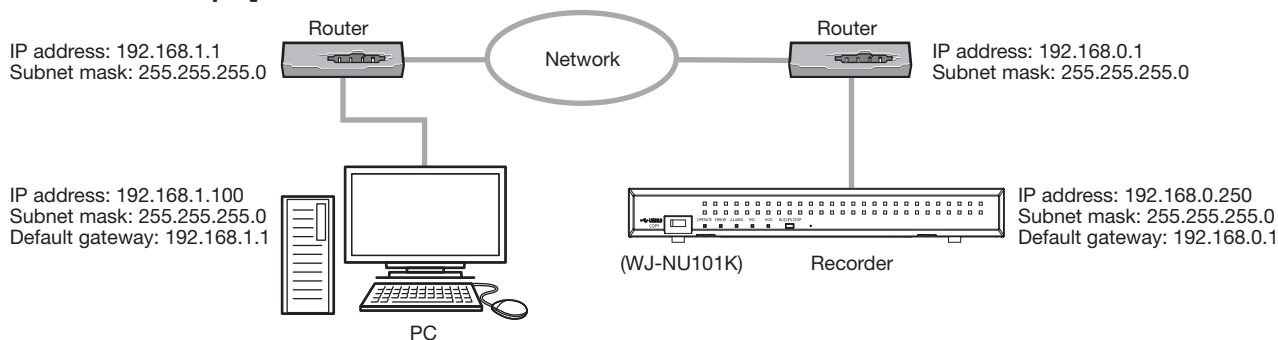

By using a firewall, etc., it is possible to use packet filtering and protocol filtering to enhance the network security.

[Setup Network]

[Connection example]

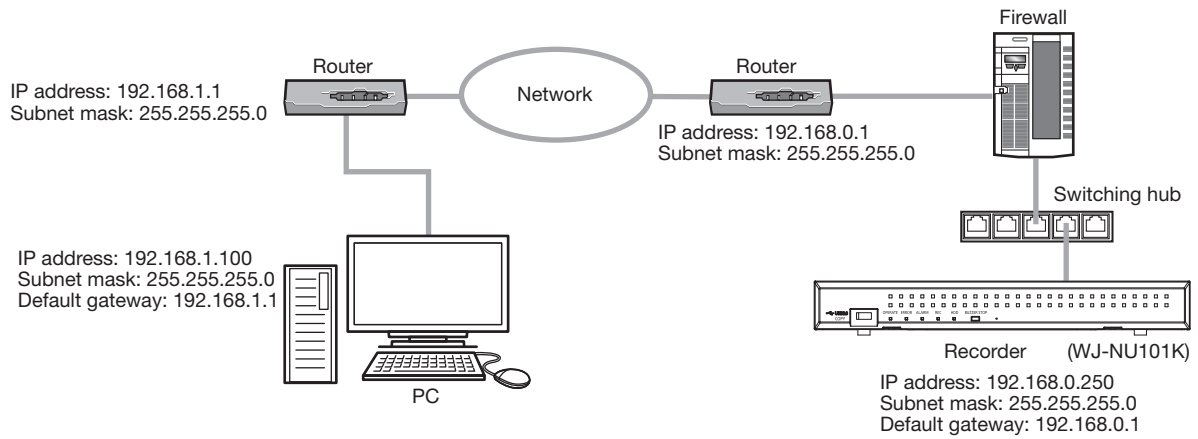

Display the operation window

Boot the PC and operate the recorder using a web browser.

Step 1

Start the web browser.

Step 2

Enter the IP address or URL assigned to the recorder into the address box, and then press the [Enter] key.

→ The authentication window will be displayed. The authentication window will not be displayed when "Off" is selected for "User authentication" on the [Basic] tab of "User management" under the setup menu [Advanced setup].

Important:

- Refer to a network administrator for further information about the set IP address.
- Since the connection method is set to HTTPS by default, add https:// at the beginning when entering an IP address or URL.
- Do not attach "0" before the numbers when entering IP address.

Example:

○: 192.168.0.50

×: 192.168.0.050

Note:

- When viewing H.265 video on multiple PCs, a license is required for each PC. The recorder has the license for 1 PC. Refer to your dealer for the software licensing.
- When using HTTPS connection, a message such as "Privacy is not protected with this connection" may appear, but HTTPS communication is possible.

Step 3

Enter the user name and password registered in the recorder, and then click the [Login] button.

→ The top page will be displayed.

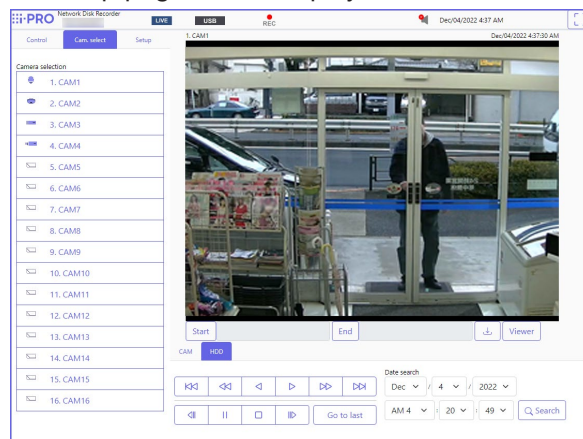

Important:

- Refer to a system administrator for the set user name and password.
- Refer to page 65 for how to register users.
- Change the password periodically. Refer to page 65 for how to change the password.

Note:

- If your web browser is set to block pop-up windows, alarm and error messages will not be displayed, and various search and copy screens will not appear.

About the operation window

Top Page



[Control] tab

Displays operations such as searching for and copying recorded images, search results and log information.

[Cam. select] tab

Can be used for switching camera images.

[Setup] tab

Can be used to configure the settings of the recorder. Refer to the "Setup via recorder's main monitor" section starting from page 10 for setup items and their further information. Refer to page 183 for basic operations.

Status display area

The current status of the recorder such as playback status, recording status, etc. will be displayed.

Current time display area

The current date & time will be displayed.

[Wide view] button

Displays the camera's live and playback images on the entire screen. (👉 page 163)

Image display area

Playback images and live images will be displayed. The camera title is displayed at the upper left and the date & time (the current date & time of the camera's clock when displaying live images and the date & time when the images were recorded when playing recorded images) at the upper right.

Download operation area

Downloads the images currently being played and the viewer software.

[CAM] tab

Camera operations such as zooming, focusing, auto mode, etc. can be performed on this tab.

[HDD] tab

Can be used to play back or operate recorded images.

Control panel

The following operation panels will be displayed when the [Control] tab is clicked.

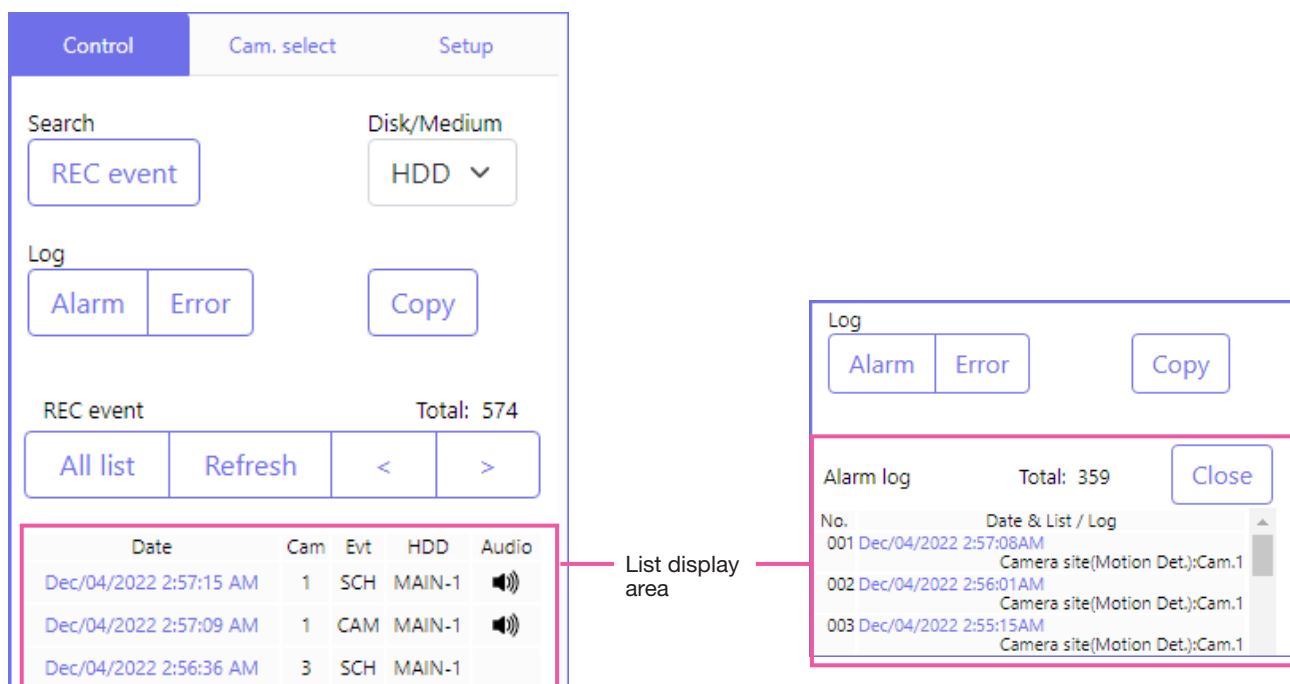

[Search] box

Use this button to search recorded images. The search result will be displayed in the list display area.

- **[REC event] button**
Select [HDD] for "Disk/Medium" to display this button. The recording event search window will be displayed.
- **[Copy data] button**
Select [USB] for "Disk/Medium" to display this button. Displays the copy data search window.

Disk/Medium

Select a destination folder to store the current playing images.

HDD/USB

[Log] box

Select a log for display.

Clicking the buttons will display the respective logs in the list display area.

Displayed logs: Alarm log, error log

- **[Close] button**
Close the window displaying log information.

[Copy] button

Select [HDD] for "Disk/Medium" to display this button.

Displays the copy window. Use this button to copy the recorded images to an external storage device.

List display area

Total: Displays the total number of listed data.

No.: The number will be displayed in the order of occurrence.

Date & List: Date & time when an event or trouble occurred will be displayed.

Log: Details of the occurred event are displayed.

The following are the maximum number of logs that can be saved. When the number of logs exceeds the limit, the older logs will be overwritten by the newer logs. In this case, the oldest log is the first to be overwritten.

Alarm log: Up to 1000

Error log: Up to 1000

Clicking date & time in the list can start playback from that date & time. (When clicking date & time in the log information, playback will be started from a point approx. 5 seconds before the date & time selected.)

To display search results or a list of copied data, refer to "Search and play recording events" (Page 171) and "Check a list of copied recorded images" (Page 176), respectively.

Note:

- To start playback from the beginning of the pre-event recording when the "Pre-event duration" setting is longer than 5 seconds, click the playback button, and then click the previous record button.
 - The corresponding recorded data that is displayed in the selected log list cannot be played if the data has already been overwritten or erased.
-

Camera selection panel

Clicking the [Cam. select] tab will display the operation panel shown below. Switch the image display area and select camera images.

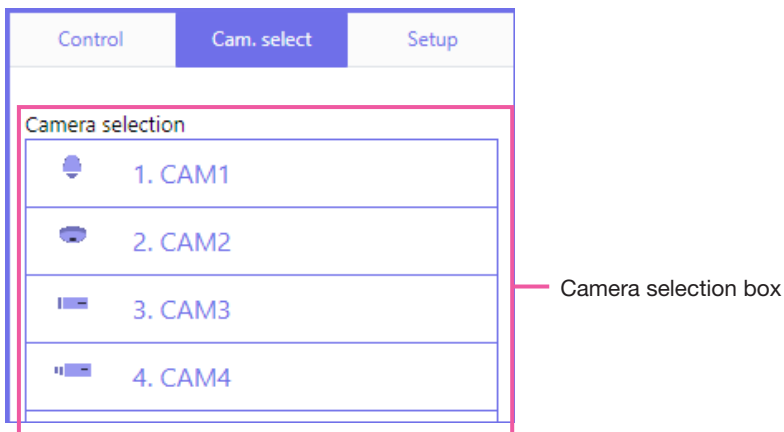
**Camera selection box**

Clicking the camera title will display images from the selected camera on a 1-screen in the image display area.

Setup panel

The following setup panel will be displayed when the [Setup] tab is clicked. The settings such as the date & time display of the recorder can be configured.

Refer to the "Setup via recorder's main monitor" section starting from page 10 for setup items and their further information. Refer to page 183 for basic operations.

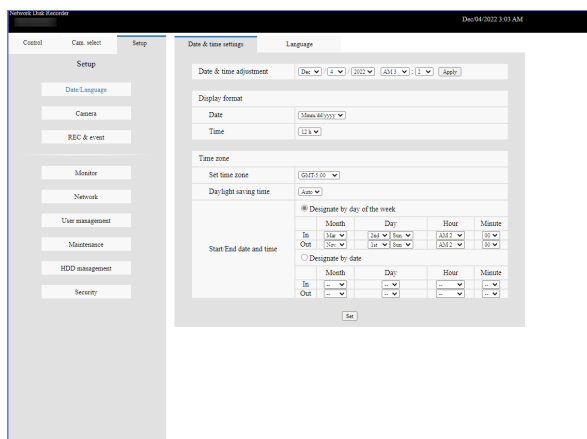

[Date/Language] button

Displays the "Date/Language" page. Perform settings such as date & time and daylight saving time.

[Camera] button

Displays the "Camera" page. Perform registration of network cameras.

[REC & event] button

Displays the "REC & event" page. Configure the settings relating to the recording schedules and alarms.

[Monitor] button

Configure the settings relating to the main monitor and the sub monitor.

[Network] button

Configure the settings relating to the network.

[User management] button

Register, edit or delete the user information. The administrator information can also be changed.

[Maintenance] button

Displays the system information of the recorder. It is used for initialization of settings and firmware update.

[HDD management] button

Format the HDD or change the operation mode of HDDs.

[Security] button

Sets the security function.

Status display area

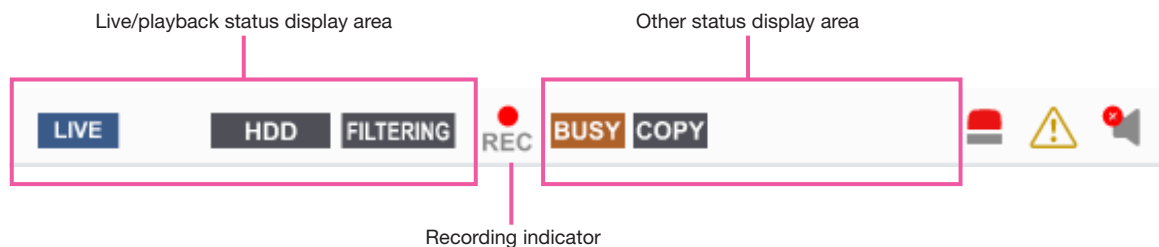

Live/playback status display area

The status of an image (live image/recorded image) will be displayed. The following information will be displayed:

- LIVE** : Indicates that live images are being displayed.
- ▶** : Indicates that playback images are being displayed.
- ◀** : Indicates that reverse playback images are being displayed.
- ▶▶** : Indicates that fast playback images are being displayed.
- ◀◀** : Indicates that fast reverse playback images are being displayed.
- ||** : Indicates that a paused image is being displayed.
- DL** : Indicates that recorded images/audio are being downloaded.
- END** : Indicates that downloading of recorded images/audio is completed.

[Step 1] - [Step 7]

Indicates the playback speed.

- Step1** : Normal playback speed (1x)
- Step2** : Approx. 2x playback speed
- Step3** : Approx. 4x playback speed
- Step4** : Approx. 8x playback speed
- Step5** : Approx. 16x playback speed
- Step6** : Approx. 32x playback speed
- Step7** : Approx. 48x playback speed

- HDD** : Indicates that the HDD is selected as playback media.
- USB** : Indicates that the USB medium is selected.
- FORMAT** : Indicates that the formatting of the HDD or the USB medium is in progress.
- SD▶HDD** : Indicates that SD memory data is being obtained.
- FILTERING** : Indicates filtering of recording events.

Recording indicator

Indicates the status of recording.

- REC** : Indicates that recording is being performed.
- REC** : Indicates that recording is not being performed.

Other status display area

Indicates the following statuses.

- BUSY** : Indicates that the camera is inoperable since a user with a higher priority is currently operating the camera.
- COPY** : Indicates that copying is being performed.
- DELETE** : Indicates that recorded images are being deleted. (Auto deletion only)

Alarm button [ALM]

This button will be displayed when an event occurs. The alarm action will be canceled by clicking this button.

Error button [ERR]

This button will be displayed when an error occurs. The error action will be canceled by clicking this button.

Note:

- Once an emergency recording starts, it will not stop even by clicking the [ALM] button. It will stop only when "Ext." is selected for "Recording duration" on the "Emergency rec." page.

Mute button [MUTE]

- 🔇** : Muted.
- 🔊** : Unmuting is in progress.

Audio output is stopped (muted) when live image display starts. Click to unmute. Click again to mute.

Download operation area

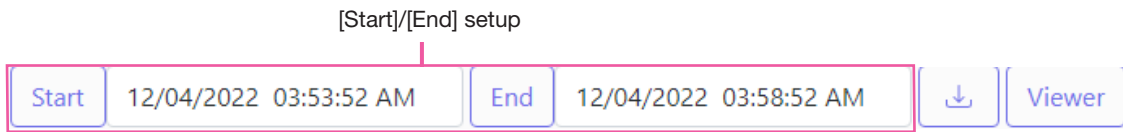

[Start]/[End] setup

Specify the time range for downloading images and audio by setting a start and end time. This operation is available only during playback on a 1-screen.
(☞ Page 175)

[Viewer] button

Download the viewer software for playing the downloaded images and audio.

[Download] button

Downloads recorded images and audio at the designated date & time.

[CAM] tab

When displaying live images from a camera with the panning/tilting function, the following camera controls are available. Depending on the model of the camera, some operations may not work. Refer to "Operate the camera" for operation. (☞ Page 164)

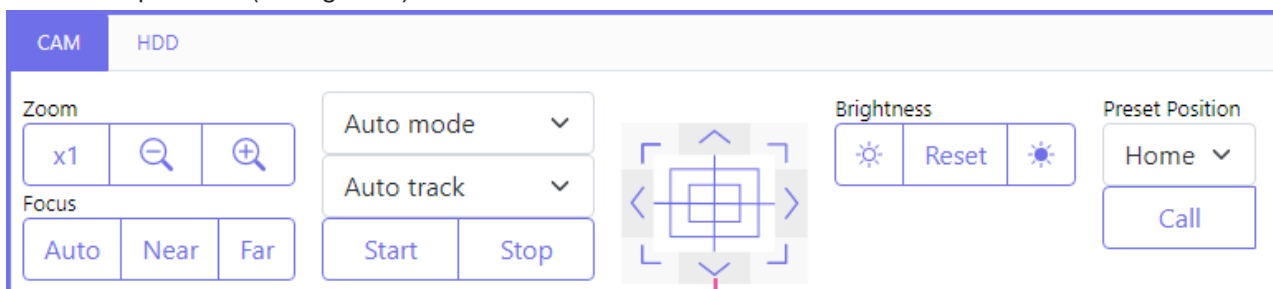

Control buttons/Control pad

[HDD] tab

Playback camera images recorded on the HDD of this product. Refer to "Play recorded images" for operation. (☞ Page 168)

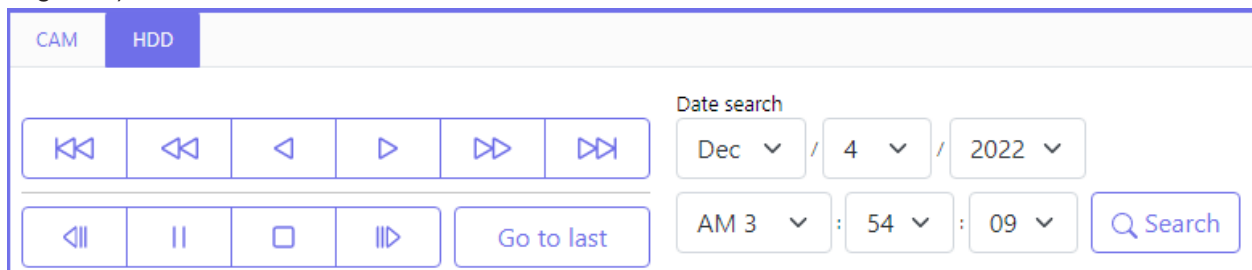

Monitor live images

Live images will be displayed in the web browser window on a 1-screen. It is possible to display live images to expand the image display area across the full screen.

Important:

- Cameras with the recording resolution set to JPEG will not be displayed.
- When the recording setting is set to On (G.711), no sound is output.
- Depending on the resolution and image quality (bit rate) setting of the camera, there may be a delay in the video display.
- If you continue to display images for a long time with the browser, the operation of the browser may become slow or the images may not be displayed. In this case, close the browser and start it again.
- If the frame rate setting is changed between scheduled recording, event recording, emergency recording, or between pre-recording and event recording, the live image may not be displayed smoothly if the frame rate is switched during the live image display.

Display live images

To display live images on a 1-screen, take the following procedures.

Step 1

Click the [Cam. select] tab. (☞ Page 159)

→ A list of the registered cameras will be displayed in the [Camera selection] box.

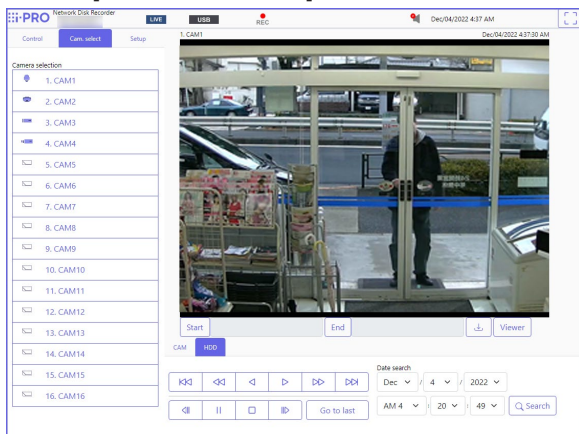

Step 2

Select the title of the camera.

→ Live images from the selected camera will be displayed on a 1-screen.

Note:

- Clicking the [Go to last] button on the [HDD] tab while displaying live images will start playback from a point around 30 seconds before the latest recorded image of the camera currently being displayed. Depending on the recording settings, images may be played back more than 30 seconds before.

Display images in wide view

Display live images across the full screen. Click the [Wide view] button (the operation panel will disappear). To return the wide view image to the original size, press the [Esc] key or click the [x] icon at the top of the screen.

Operate the camera

When displaying live images from a camera with the panning/tilting function, the following camera controls are available. It may be impossible to operate the camera or some functions may be inoperable depending on the model of the camera.

- Panning/Tilting • Zoom • Focus • Brightness • Preset position operation • Auto mode/AUX/Wiper

To operate the camera, display the [CAM] tab of the top page.

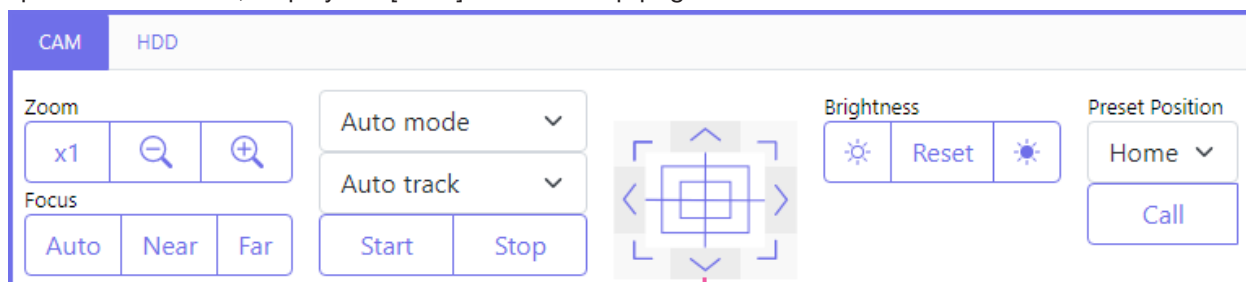

Control buttons/Control pad

Camera operation is as follows.

Function	Function Description	Operation
Pan/Tilt	Adjusts the horizontal/vertical position of the camera image.	<p>Control buttons Click to adjust the camera orientation.</p> <p>Control pads Click to adjust the camera orientation. The more you click outside of the center of the pad, the more pan/tilt movement you will get.</p>
Zoom	The camera image will be enlarged or compressed in the display.	Click the [-] button or the [+] button. Click the [x1] button to return the zoom magnification to 1x.
focus	Adjusts the focus of the camera image.	Click the [Far] or [Near] button. Click the [Auto] button to automatically adjust the focus.
Brightness	Adjusts the aperture of the lens.	Click the ☀ or ☀ button. Click the [Standard] button to return brightness setting to standard.
Preset registration	Registers the current camera orientation to the selected preset position.	<p>Pan/tilt the camera to the desired orientation.</p> <p>Click the [▼] button in the Preset box, select the preset number (1 to 256) you wish to register, and click the "Register" button.</p> <p>Note</p> <ul style="list-style-type: none"> • Some preset numbers cannot be registered depending on the connected camera model. • "Home" cannot be registered.
Preset move	Moves the camera orientation to the position preset in the preset registration.	Click the [▼] button in the Preset box, select a preset number (Home, 1 to 256), and click the "Move" button.

[Operation via PC web browser]

Function	Function Description	Operation
Auto mode	Activates the Auto mode function set in the camera.	<p>Select "Auto mode" as the operation mode and click the [▼] button to select the following camera's auto mode. Click the [START] button to start the camera in Auto mode. Click the [Exit] button to exit the Auto mode.</p> <ul style="list-style-type: none"> ● Auto-Following/Tracking: The camera automatically tracks moving objects on the screen. ● Auto Pan: The camera automatically rotates within the range of the pan start and end positions set in advance. ● Preset Sequence: Moves through the preset positions registered in advance in the camera, starting with the lowest preset number. ● Patrol: Performs the operations recorded in advance by the camera. <p>Note Set the Auto mode in the camera menu before use.</p>
AUX operation	The device connected to the AUX terminal of the camera is set to the Open/Closed state.	<p>Select "AUX" as the operation mode and click the [▼] button to select the AUX terminal number.</p> <ul style="list-style-type: none"> ● Click the [Open] button to open the AUX terminal of the camera. ● Click the [Close] button to close the AUX terminal of the camera. <p>Note AUX terminal number selection is valid only for WJ-GXE500. For cameras other than WJ-GXE500, only Open/Close operation is possible.</p>
Wiper operation	Operate the washers/wipers on the WV-SUD638.	<p>Select "Wiper" as the operating mode, click the [▼] button, select the following camera wiper functions, and click the [Start] or [End] button.</p> <ul style="list-style-type: none"> ● High-speed: Continuous wiping operation. (once every 4 seconds) ● Low-speed: Continuous wiping operation (once every 8 seconds) ● Temporary control: Performs 5 wiping operations at high speed (once every 4 seconds). ● Washer: Performs the specified washer/wiper operation. <p>Note</p> <ul style="list-style-type: none"> ● The following operations cannot be performed while the washer is in operation. <ul style="list-style-type: none"> • "Wiper" function - [Start] and [End] operations • Pan, tilt, zoom, and focus control • "Auto mode" - [Start] operation • "Preset" - [Move] operation ● Washer operation setting is required on the camera side. For more information, refer to the Operating Instructions of WV-SUD638.

Event function

The recorder will take an event action when any of the following events occur.

- Terminal alarm: An event when an alarm input signal is supplied from an external device such as a door sensor to the alarm input terminal on the rear of the recorder.
- Camera site alarm: An event when an alarm (camera terminal alarm, etc.) is detected by a camera.
- Command alarm: An alarm when receiving an alarm from a PC, etc. via a network.

Action to be taken upon an event occurrence

When the recorder recognizes an event, it will take an event action according to the set action mode. Refer to the "Event action mode" (☞ Page 123) for further information about the event action and action mode. The actions that can be set up and checked from a PC when an event occurs are described below.

Display the alarm message

A window that notifies of an event occurrence will be displayed.

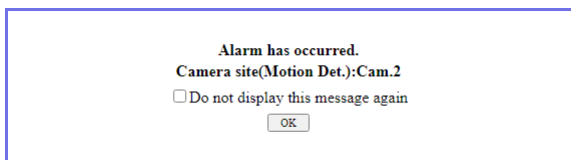

Click the [OK] button or the [×] button to close the window. When several events occur at the same time, the information for the event that occurred last will be displayed. When you check "Do not display this message again", the alarm message will not be displayed until the web browser is restarted even if an event occurs.

Display the alarm button

The [ALM] button will be displayed in the status display area. The alarm action will be canceled by clicking [ALM] button. (☞ Page 167)

Display the error button

The [ERR] button will be displayed in the status display area. The error action will be canceled by clicking [ERR] button. (☞ Page 167)

Cancel the alarm action

To cancel the alarm action manually, click the [ALM] button in the status display area.



→ The alarm action will be canceled. The event recording will stop and return to the operational status just before the event occurred.

Cancel the error action

When an error (trouble) occurred on the recorder, the recorder will take the error action (a series of actions that notifies of the error occurrence). An error display window providing information on the error that occurred will be displayed on the web browser. To cancel the error action manually, close the error display window, and click the [ERR] button in the status display area.

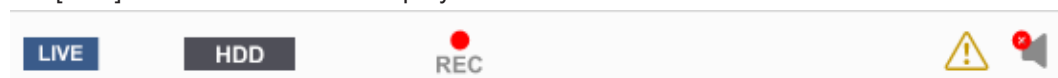

→ The error action will be canceled.

Note:

- When an error occurs, take remedial action by following the instructions displayed on the error log panel (Page 137). The error indicator on the front of the recorder will go off when the cause of the error has been eliminated.
 - The [ERR] button is continuously displayed even if the cause of the error is automatically resolved. Click the [ERR] button to turn it off.
-

Play recorded images

Display camera images recorded on the recorder's hard disk. There are 2 ways to play recorded images as follows. Play image recorded at a designated date & time. Search and play recorded images. Playback operation can be made while recording.

Important:

- Audio cannot be played.
- The maximum number of browser connections that can play simultaneously is two. The number of connections includes the number of mobile regenerations of the i-PRO Mobile APP smartphone application. When two browsers are running, a user at the same level cannot run a third browser. When using a sub-monitor, the maximum number of connections is limited to one.
- Depending on the compression method, resolution, frame rate, etc. of the recorded images, the replay speed may be slower.
- If the frame rate of the recorded image is more than 15 ips, the image is resumed with a shortened frame rate.
- If the browser is closed during the playback, it takes about 90 seconds before the next time the browser is connected, the playback will be ready. It is OK to stop the playback and exit the browser.
- If the corrected display of the fisheye image is performed, playback may stop. If the display screen is not updated, click the [Stop] button on the [HDD] tab.

Step 1

Click the [HDD] tab on the top page of the operation window.

→ The [HDD] tab will be displayed.

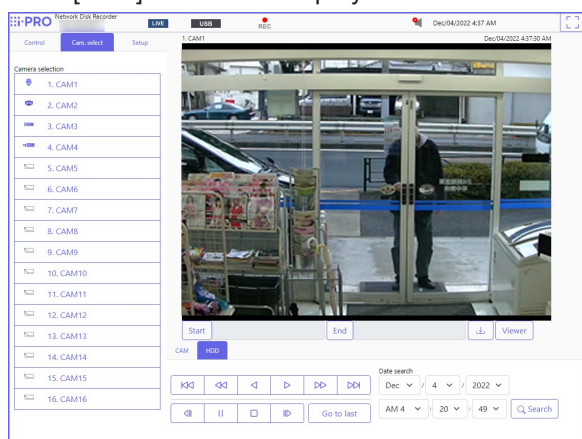

Step 2

Click the [Play] button.

→ Playback of a recorded image will be performed. The "Playback" indication and the "Step 1" indication will be displayed on the status display area.

Playback will start from the point at which the last playback was stopped (date & time).

Step 3

Click the [Stop] button on the [HDD] tab.











→ "Playback" and "Step 1" will disappear from the status display area, and playback will stop. Live images from the camera will be displayed on the image display area.

Note:

- When starting playback for the first time after login, playback will start from a point around 30 seconds before the latest recorded image. While recording, the playback starts 30 seconds prior to the current time. Depending on the recording settings, images may be played back more than 30 seconds before.
- When load to be processed is too heavy for the recorder (such as when many cameras are connected, images (live/playback) are displayed on many windows (segments)), playback speed may become slow or playback may stop for a while.
- The camera image can be changed by clicking the [Cam. select] tab and the camera title during playback.
- The playback video may temporary stop or the image may not be displayed if the vicinity of the current time is continuously being displayed.

About playback operation

The following operations are available during playback:

Function	Example	Operation
[Play]/[Rev play] button	 / 	<ul style="list-style-type: none"> Plays recorded images. Plays back recorded images in reverse. * Playback and reverse playback may not work when the [Play] or [Rev play] button is clicked while recording images at a lower frame rate.
[Stop] button		<ul style="list-style-type: none"> Playback will stop and live images will be displayed when this button is clicked during playback.
[Pause] button		<ul style="list-style-type: none"> Playback will be paused when this button is clicked during playback. Playback will resume when this button is clicked during pause.
[FF]/[FR] button	 / 	<ul style="list-style-type: none"> Playback speed of fast playback will be changed in the following order each time the [FF] button is clicked: Step2 (Approx. x2) → Step3 (Approx. x4) → Step4 (Approx. x8) → Step5 (Approx. x16) → Step6 (Approx. x32) → Step7 (Approx. x48) Playback speed of fast reverse playback will be changed in the following order each time the [FR] button is clicked: Step2 (Approx. x2) → Step3 (Approx. x4) → Step4 (Approx. x8) → Step5 (Approx. x16) → Step6 (Approx. x32) → Step7 (Approx. x48) The step of the playback speed will be displayed on the playback status display. * When playing H.264/H.265 images, some frames of recorded images will not be displayed. Fast playback/fast reverse playback of images will be performed with the refresh interval setting of the camera.
[Next record]/[Prev record] button	 / 	<ul style="list-style-type: none"> When the [Next record] button is clicked, playback point will skip to the start time of the next recorded images. When the [Prev record] button is clicked, playback point will skip to the start time of the previous recorded images. * When there is no next/previous recorded image to be skipped to, the current playback will continue. In this case, playback time of the current playback may sometimes be displayed as around for 1 minute ago.
[Next image]/[Prev image] button	 / 	<ul style="list-style-type: none"> The next frame will be displayed when the [Next image] button is clicked during playback/pause, and playback will pause. The previous frame will be displayed when the [Prev image] button is clicked during playback/pause, and playback will pause. * When playing H.264/H.265 images, some frames of recorded images will not be displayed. Reverse frame-by-frame playback will be performed with the refresh interval setting of the camera.
[Go to last] button		<ul style="list-style-type: none"> When this button is clicked, playback of the latest recorded images will start. The starting point is around 30 seconds before the date & time of the latest recorded images. While recording, the playback starts 30 seconds prior to the current time. Depending on the recording settings, images may be played back more than 30 seconds before. * When the [Go to last] button is clicked while recording images at a lower frame rate, playback of the latest recorded images may be paused or images may not be displayed. The playback video may temporary stop or the image may not be displayed if the vicinity of the current time is continuously being displayed.

Play image recorded at a designated date & time

Start playback by designating the desired date & time of a recorded image. Playback operation can be made while recording.

Step 1

Click the [Cam. select] tab on the top page of the operation window, and select a camera for playback from the camera selection box. (☞ Page 159)

Step 2

Click the [HDD] tab. (☞ Page 157)

Step 3

Click the [▼] button and determine the date & time of the desired images.

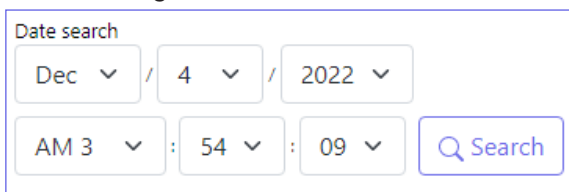

The screenshot shows a 'Date search' form with two rows of dropdown menus. The first row contains 'Dec', '4', and '2022'. The second row contains 'AM 3', '54', and '09'. To the right of the second row is a 'Search' button with a magnifying glass icon.

Step 4

Click the [Date search] button.

→ "Playback" and "Step 1" will be displayed in the status display area, and playback will start from the image corresponding to the designated date & time.

(About playback operation: "Play recorded images" (☞ Page 169))

Note:

- When playing H.264/H.265 image by designating date & time, playback may start from a point several seconds before or after the designated date & time.
 - When no recorded image found at the designated date & time, playback of images recorded after and at the closest to the designated date & time will start.
-

Search and play recording events (REC event search)

Search the recording event list for a recording event and play it back.

Important:

- To use recording event search, "HDD" must be selected for [Disk/Medium].
It is also possible to filter recording events using the search filters.

Step 1

Click the [Control] tab on the top page (☰ Page 157) of the operation window, and click the [REC event] button in the [Search] box.

→ The recording event search window will be displayed.

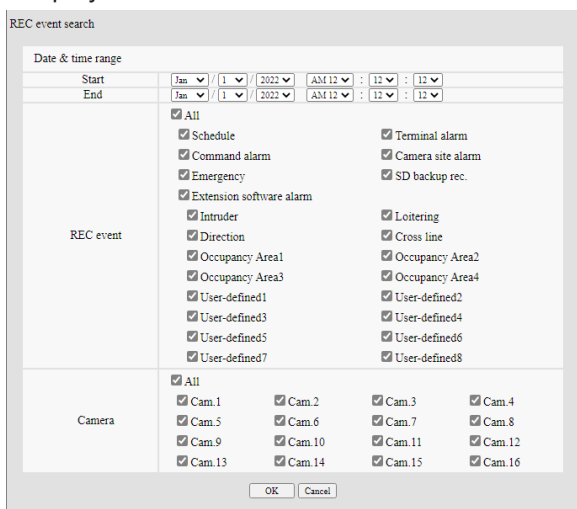

Step 2

Specify the search conditions (filters).

[Date & time range]

Select a time range by designating a start and end date & time. The designated time range will be searched.

[REC event]

Searches for images recorded by the selected recording mode only. Check the checkbox corresponding to the desired event type. When the checkbox for [All] is marked, the checkboxes of all of the following events can be marked:

- Schedule [SCH]: Recording by the schedule recording event
- Terminal alarm [TRM]: Recording triggered by a terminal alarm
- Command alarm [COM]: Recording triggered by a command alarm
- Camera site alarm [CAM]: Recording triggered by camera site alarm
- Emergency [EMR]: Recording triggered by the emergency recording event

- SD backup rec. [SD]: Recording by the SD memory backup function
- Extension software alarm [SW1~SW16]: Record by extension software alarm

Note:

- When you search Extension software alarm, the event type in the search result list is displayed as follows for each event. Each name is in case of default setting.
Intruder: SW1, Loitering: SW2, Direction: SW3, Cross line: SW4
Occupancy Detection Area 1~Occupancy Detection Area 4: SW5~SW8, User-defined 1~User-defined 8: SW9~SW16
- User-defined 1 to user-defined 8 of the extension software alarm are displayed when the message ID of the extension software alarm (☰ page 49) is set.

[Camera]

Searches for images recorded with each selected camera. Mark the checkbox corresponding to the desired camera. When the checkbox for [All] is marked, the checkboxes of all cameras can be marked.

Step 3

Click the [OK] button.

→ "FILTERING" appears in the status display area, and the filtered result will be displayed in the list display area.

The screenshot shows a web browser interface with a top navigation bar containing 'Control', 'Cam. select', and 'Setup'. Below this, there are search and log controls. The 'Search' section has a text input field containing 'REC event' and a 'Disk/Medium' dropdown menu set to 'HDD'. The 'Log' section has buttons for 'Alarm', 'Error', and 'Copy'. Below these controls, it displays 'REC event' and 'Total: 602'. There are navigation buttons: 'All list', 'Refresh', '<', and '>'. At the bottom, there is a table with columns: Date, Cam, Evt, HDD, and Audio.

Date	Cam	Evt	HDD	Audio
Dec/04/2022 3:44:25 AM	1	SCH	MAIN-1	🔊
Dec/04/2022 3:44:24 AM	4	SCH	MAIN-1	🔊
Dec/04/2022 3:37:01 AM	1	SCH	MAIN-1	🔊
Dec/04/2022 3:36:29 AM	1	CAM	MAIN-1	🔊

[Total]

Displays the total number of searched data. When more than 10001 data matched, the "> 10000" indication will be displayed.

[All list] button

Cancels filtering and displays all recording events.

[Refresh] button

Updates the list to the latest one.

[Prev page (<)] button

Displays the previous page of the list.

[Next page (>)] button

Displays the next page of the list.

[Date]

Start time of recording will be displayed.

[Cam]

The camera which recorded the images will be displayed.

[Evt]

Event type will be displayed. (📖 Page 171)

[HDD]

The hard disk drive number in which the corresponding recorded images are stored will be displayed.

[Audio]

When audio is attached to recorded images, the audio icon will be displayed.

Note:

- The [All list] button will become unavailable during playback. To use the [All list] button, stop playback and click it.
 - When many cameras are connected, the recording start time of each camera may sometimes not be the same.
-

Step 4

Click the date & time of the desired recording event.

→ Playback of recorded images of the selected recording event will start. (About playback operation (📖 Page 169))

Copy recorded images

Copy the recorded image on the recorder to an external storage device (external HDD, USB memory stick). Refer to page 142 for further information about the copy function. Refer to page 178 for information on how to play copied images.

Step 1

Click the [Control] tab on the top page (Page 157) of the operation window.

Step 2

Click the button in the [Copy] box.

Date	Cam	Evt	HDD	Audio
Dec/04/2022 3:44:25 AM	1	SCH	MAIN-1	🔊
Dec/04/2022 3:44:24 AM	4	SCH	MAIN-1	🔊
Dec/04/2022 3:37:01 AM	1	SCH	MAIN-1	🔊
Dec/04/2022 3:36:29 AM	1	CAM	MAIN-1	🔊

→ The "Copy" window will be displayed.

Step 3

Specify the detailed conditions of recorded images to be copied. Specify the information to be set as conditions.

Copy

All
 Cam.1 Cam.2 Cam.3 Cam.4
 Cam.5 Cam.6 Cam.7 Cam.8
 Cam.9 Cam.10 Cam.11 Cam.12
 Cam.13 Cam.14 Cam.15 Cam.16

Start: Dec / 4 / 2022 AM 4 : 21 : 34
End: Dec / 4 / 2022 AM 4 : 26 : 34

File format: Original (n3r/n3a) MP4

Alteration detection: On Off

Assign a password
Password (5 to 8 characters):
Retype password:

Data size: --- GB

Free: --- GB

[Camera]

Select the camera you wish to copy. Mark the checkbox next to the desired camera. When the checkbox for [All] is marked, the checkboxes of all cameras can be marked.

[Date & time range]

Designate the start point (start date & time) and the end point (end date & time) of recorded images to be copied. Click the [▼] button, and then designate date & time.

[File format]

Select the file format (Original (n3r/n3a)/MP4) of the recorded data to be copied. Mark the checkbox corresponding to the desired file format.

[Alteration detection]

Determine whether or not to attach the alteration detection code to the recorded images to be copied. When the alteration detection code is attached, it is possible to check if the copied recorded images have been altered or not when playing the copied recorded images using the viewer software. Click the [▼] button, and then select "On" or "Off".

[Password]

To copy with password protection, mark the corresponding checkbox and enter a password. (5 to 8 alphanumeric characters) The password will be required to play back the copied data.

[Data size]

When the [Measurement] button is clicked, size of the data to be copied will be displayed.

[Free]

The remaining capacity of the destination medium (external storage device) will be displayed.

Step 4

When the [OK] button is clicked, the confirmation window will be displayed. Then click the [OK] button on the displayed confirmation window.

→ The data copy window will close. Copying will start and the "COPY" icon will be displayed in the status display area. When copying is complete, the "COPY" icon will disappear.

Important:

- When copying to an external storage device is being performed, do not disconnect the external storage device. Otherwise the data stored on the external storage device could be lost.
 - When the copy end time is set earlier than the start time, copying will not start even when the [OK] button is clicked.
 - When copy medium lacks enough storage space, data will be copied until the copy medium is full. Use a medium with sufficient storage capacity to avoid left over data that is not copied.
 - Copying will be performed in the following order: Viewer Software → Images → Audio Depending on the designated time range for copying and the remaining space of the storage medium, images and audio may not be copied.
 - When clicking the button in the [Copy] box during copying, the confirmation window for cancellation of the current copying will be displayed. It is possible to cancel the current copying on this window.
 - Do not turn off the power of the recorder while copy is in progress. If the power is turned off while copying, the storage media copied on will become unusable.
 - Recorded images (data) of up to 1 million can be copied onto the external device connected to the copy port "COPY". However, it is impossible to copy any more data exceeding these limits even when there is a sufficient remaining capacity.
 - When another user operating the recorder has opened the copy panel or when the destination medium has been selected by another user, the copy window cannot be displayed.
 - When the web browser is closed during the copying process, the process will be stopped. Do not close the web browser during the copying process.
-

Download recorded images currently being played

Designate the start point and the end point of recorded images currently being played and download images to a PC.

When a playback image is downloaded, it is downloaded as an image data file (file name .n3r) and a sound data file (file name .n3a). Refer to page 178 for information on how to play downloaded recorded images.

Important:

- When download is canceled in the process of the download, it is impossible to properly play the downloaded file on a PC.
- The file cannot be download in MP4 format.

Step 1

Click the [HDD] tab on the top page (☰ Page 157) of the operation window.

Step 2

Play back the recorded images.

Click the [Start] button in the download operation area at the playback point where the download is to start. Another way to start the download is to click the start time box and enter date & time.

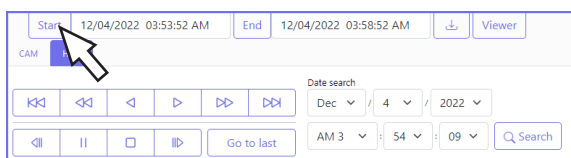

→ The date & time set in the start time box will be displayed.

Step 3

Click the [End] button in the download operation area at the playback point where the download is to end. Another way to end the download is to click the end time box and enter date & time.

→ The date & time set in the end time box will be displayed.

Note:

- It is possible to designate up to 60 minutes of the time range per download.

Step 4

Click the [Download] button.

→ The "Download" window will be displayed.

Step 5

Select the file format "With audio" or "Without audio" to determine whether or not to download images with audio, and select "On" or "Off" to determine whether or not to attach an alteration data on downloaded images due to alternation detection. When assigning a password, enter 5 to 8 alphanumeric characters for the password. When the setting is completed, click the [OK] button.

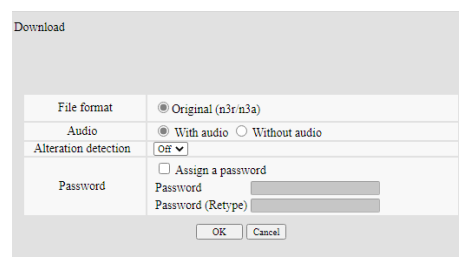

→ The file download will be started.

Note:

- When the size of the file being downloaded exceeds 2GB, the download will be terminated at that point.
- During download, cameras switching or setting menu display is not available. Please wait until the download is completed.
- The image may be downloaded from a few seconds before* the specified start date and time.
* The time depends on the refresh cycle setting of the camera (setting range: 0.2 to 5 sec). The camera refresh cycle setting is set to 1 second when the camera is registered. Refer to the Operating Instructions of the camera for the refresh cycle settings.

Check a list of copied recorded images

Display a list of data (recorded images) copied on the external storage device and confirm them. It is possible to search for copied data using filters. Available filters are "Date & time range" and "Camera".

Step 1

Insert the external storage device on which the recording data is copied.

Step 2

Click the [Control] tab on the top page (Page 157) of the operation window.

Step 3

Select [USB] for "Disk/Medium" in the [Search] box, and then click the [Copy data] button.

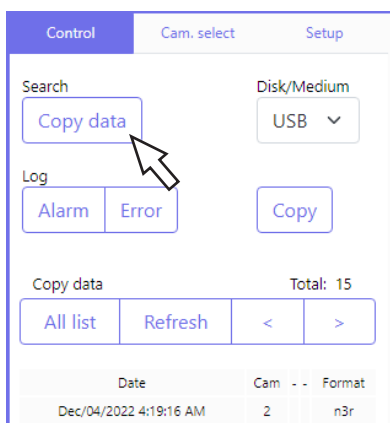

→ The copy data search window will be displayed.

Step 4

Specify the search conditions (filters).

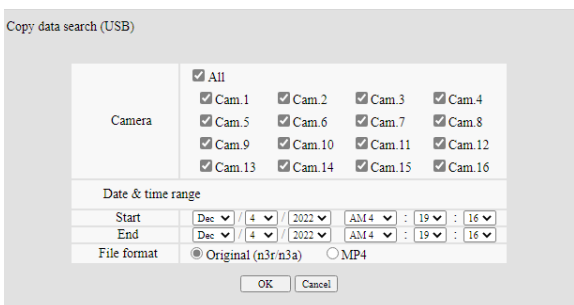

[Camera]

Searches for images recorded with each selected camera. Mark the checkbox corresponding to the desired camera. When the checkbox for [All] is marked, the checkboxes of all cameras can be marked.

[Date & time range]

Select a time range by designating a start and end date & time. The designated time range will be searched.

[File format]

Searches for images recorded with each selected file format. Mark the checkbox corresponding to the desired file format.

Step 5

Click the [OK] button.

→ Copied data matching the search criteria will be displayed on the list display window.

Copy data		Total: 15	
Date	Cam	Format	
Dec/04/2022 4:19:16 AM	2	n3r	
Dec/04/2022 4:19:16 AM	3	n3r	
Dec/04/2022 4:19:15 AM	1	n3r	
Dec/04/2022 4:19:15 AM	4	n3r	
Dec/04/2022 4:09:05 AM	1	n3r	
Dec/04/2022 4:09:05 AM	2	n3r	
Dec/04/2022 4:09:05 AM	3	n3r	
Dec/04/2022 4:09:05 AM	4	n3r	
Dec/04/2022 4:05:10 AM	1	n3r	
Dec/04/2022 4:05:10 AM	2	n3r	
Dec/04/2022 4:05:10 AM	3	n3r	
Dec/04/2022 4:05:10 AM	4	n3r	
Dec/01/2022 2:51:06 AM	1	n3r	
Dec/01/2022 2:27:28 AM	1	n3r	
Dec/01/2022 2:23:47 AM	1	n3r	

[Total]

Displays the total number of searched data. When more than 10001 data matched, the "> 10000" indication will be displayed.

[All list] button

Cancels filtering and displays all recording events.

[Refresh] button

Updates the list to the latest one.

[Prev page (<)] button

Displays the previous page.

[Next page (>)] button

Displays the next page.

[Date]

Start time of recording will be displayed.

[Cam]

The camera number of the recorded data will be displayed.

[Format]

Displays a file format.

Important:

- Do not remove the external storage device during playback of the list of copied data. Otherwise the data stored on the external storage device could be lost.
-

Note:

- When copying large amounts of data, more time is needed to display the list.
 - If you check the list of another external storage device, select the "HDD" on [Disk/Medium] of [Search] box and then select "USB" again.
 - Refer to page 178 for information on how to play copied images.
-

Play back the copied/downloaded images on a PC

The original file or MP4 file is copied to the destination when the playback image is copied or downloaded. It is possible to play, save and print the copied/downloaded data files using the dedicated viewer software. The MP4 file can be played on the general playback software.

To play recorded images copied on the media device

The executable file of the viewer software (NX_Viewer.exe) is also saved directly under the drive when images are copied to the medium.

Double click the executable file to launch the viewer software when you play the copied images in the medium. Refer to page 179 for how to use the viewer software.

Play recorded images downloaded using a web browser

Download the viewer software (compressed file: NX_Viewer.zip) and extract the file. Expanding the folder creates the NX_Viewer folder. In this folder you will find the viewer software executable file (NX_Viewer.exe). Refer to page 179 for how to use the viewer software.

Download the viewer software

Click the [Viewer] button in the download operation area on the top page (☞ Page 157) of the operation window. (☞ Page 162)

→ The file will be downloaded.

How to use the viewer software

To start the viewer software, double-click the executable file (NX_Viewer.exe) in the external storage device if you copied it to an external storage device, or the executable file in the extracted folder if you downloaded it from a web browser.

Note:

- The license agreement window will be displayed when you first launch the viewer. The viewer software is launched when you accept the license agreement.

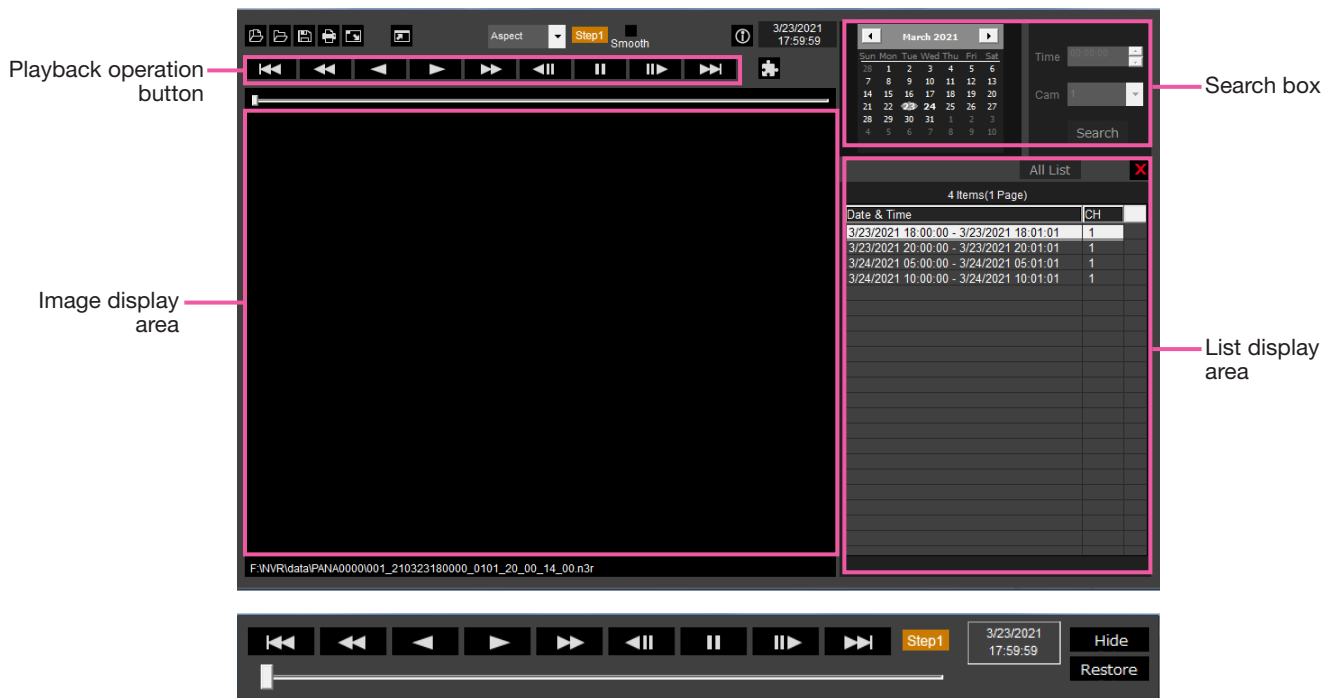

Playback operation window when images are displayed on a full screen

Important:

- The viewer software requires a license for each PC. The recorder has the license for 1 PC. Additional licenses are required when you use the viewer software with more than 2 PCs at the same time. Contact your dealer for the license.

Select playback images

Step 1

Click the  button.

→ The "Open" window will be displayed.

Note:

- When you run the executable file copied to the external storage device, the file open window will be automatically displayed.

Step 2

Select the image data file (filename.n3r, filename.mp4), and click the [Open] button.

→ The information on the file selected in the list display area will be displayed.

Recording date and time: Displays a start time and an end time for copying the recorded images.

Recording CH: Displays the camera number.

Note:

- It is possible to select multiple files (up to 100 files) by clicking the desired files while holding down the [Ctrl] key or the [Shift] key and display all of them in a list by drag & drop.

- Do not change the file name of the copied or downloaded image data. If the file name is changed, the file information will not be displayed correctly.
- The image data file can be selected by dragging and dropping the file on the viewer software without opening the file open window.
- The files can be sorted by start date & time in ascending or descending order by clicking the header of the list display area,
- To add image data to the list display area, right-click the list and select [Add file] from the menu displayed. When the window for opening files is displayed, proceed to Step 2. The image data is added to the list.
- When the number of displayed image data files has reached 100, no more files can be added. The number of the image data is displayed on the top of the list.
- Clicking the  button will delete all data displayed on the list. Another way to clear the list is to right-click the list and select [Clear all list].
- Image data after 2038 cannot be played back.









Playback downloaded images

Use the playback operation button to play downloaded images. If the same camera channel is displayed on the list, the next list image in playback mode or the previous list image in reverse playback mode will be played back consecutively. If the same camera channel is not displayed on the list, playback will stop, the image display area will turn black and playback will be paused.

Note:

- If a password is given to the data, the password will be required. The image will be played only when the correct password is confirmed.
- Playback images and audio may sometimes not be synchronized exactly.

The playback operation buttons enable the following operations.

- | | | |
|-----------------------------|---|---|
| [Play] button |  | : Starts the playback. |
| [Rev play] button |  | : Plays the image backwards. |
| [FF] button |  | : Plays the image at high speed. |
| [FR] button |  | : Plays the image backwards at high speed. |
| [Pause] button |  | : Pauses the playback. |
| [Next image] button |  | : Moves to the next image. It is operable only when playback is paused. |
| [Prev image] button |  | : Returns to the previous image. It is operable only when playback is paused. |
| [Next record] button |  | : Plays the next recording file on the list. |
| [Prev record] button |  | : Plays the previous recording file on the list. |

The playback position can be changed with the slider bar. When the slider bar is moved, the image will be paused. Restart the playback with the [Play] button.



Change the playback time and date

Play image recorded at a designated date & time

Selecting a date from the calendar, assigning time and a recording channel and clicking the [Search and play] button will start to play the image of the assigned date and time.

The filtered date is displayed with a red circle on the calendar.

Play an image by selecting it from the list

Selecting a line on the list will play the image of the selected date and time, and the recording channel.

Clicking it will pause playback at the first image and double-clicking will start the playback.

Make the image easy to see

Display enlarged images

When setting a cursor on the image display and manipulating the mouse wheel, digital zoom is displayed.

Clicking the image during zoom display changes the screen center to the clicked position.

Change the display size

 Enlarges the window screen display.

 Returns the enlarged window screen display to the original size.

 Display the image maximized to the whole window.

The maximized image to the whole window is returned to the original by the [Back] button or the [Esc] key.

Change the display format

 Aspect Displays the image in the screen with the aspect ratio kept.

 Scaling Displays the image with it expanded or contracted to fit in the screen.

 PixelByPixel Displays 1 pixel of the screen on 1 dot.

When you click the image in the screen, the center position changes to the point where you have clicked.

Smooth the high-speed playback

 Smooth Checking the box enables a smooth, high-speed playback.

The fast playback speed may be limited depending on the performance of the PC in use or process status.

Plays the fisheye image of the fisheye network camera (made by i-PRO, hereinafter called "fisheye camera")

When you select a fisheye image which can be corrected, the image will be corrected and displayed on 1-screen PTZ/4-screen PTZ.

After clicking the image during corrected display on 1-screen PTZ/4-screen PTZ, the clicked position will be centered on the screen.

 Returns the image to the fisheye image.

 Corrects the image on 1-screen PTZ.

 Corrects the image on 4-screen PTZ.

Fisheye images other than those manufactured by us or Panasonic cannot be corrected and displayed.

Adjust the volume

When the audio data (filename.n3a) is available, a button to adjust the audio will be displayed.



Adjusts the volume. Clicking the button can switch the volume in three levels.

 Toggles Audio playback/Silent.

If the audio is controlled or adjusted by another application, the audio may not be played correctly on the viewer software. To play the audio correctly, adjust the audio only with the viewer software.

Detect alteration of the image data

It is possible to detect alteration in downloaded data to which a code for alteration detection has been attached. Confirm whether the played image has been altered or not by the following procedures.

Step 1

Select the data to detect alteration on the list and click the  button.

→ File advanced window will be displayed.

Step 2

Select the [Check alteration] and click the [Execute] button.

→ Starts alteration detection and displays the results once the detection has been completed.

Save still images

Save an image displayed in the image display area as a JPEG file on a PC.

: Saves the image on pause in JPEG file with a new name.

Save image data (copy)

Save selected image data (filename.n3r) in any folder on the PC.

Step 1

Right-click the list and select [File advanced function] from the displayed menu.

→ File advanced window will be displayed.

Step 3

Designate the folder name and destination drive and click the [Save] button.

→ Starts saving the image data and displays results once the saving has been completed.

Step 2

Select the [File output] and click the [Execute] button.

→ The "Save As" window will be displayed.

Print the displayed image

Print the image displayed in the image display area.

: Prints the image on pause with the date and time.

Setup

Basic operations

Step 1

Click the [Setup] tab.

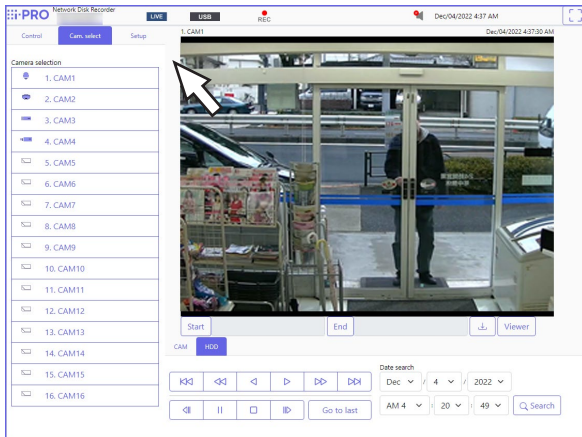

Step 2

Click the button for the desired menu.

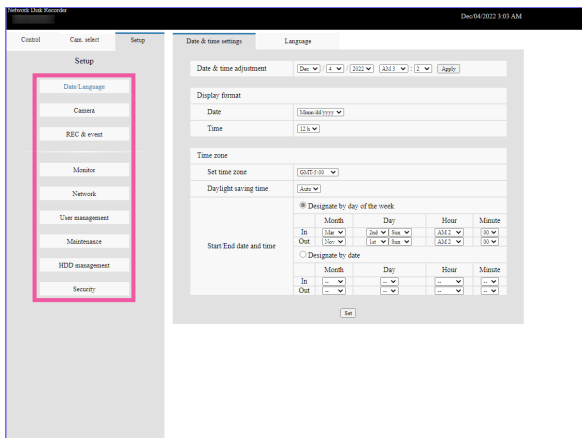

Step 3

Click the button for the desired submenu.

Step 4

Configure each setting item. Click the [Set] button after completing the settings.

→ The settings will be applied. When moving to another page without clicking the [Set] button, the configured settings will be canceled.

Important:

- If the settings are applied, other login users will be forcibly logged out.
- If the settings relating to the user management are applied, all login users will be forcibly logged out.
- Recording may not be performed for around 4 seconds just after the settings are applied.

Configure the settings

It is possible to configure the settings of the recorder using a web browser.

Refer to page 81 for setup items that can be configured from the web browser and their further information.

Display data output logs

Click the [View>] button of [Data output logs] in [Maintenance] - [System administration] to check the history of users who have copied or downloaded data. Up to 100 records are stored, and when the number of records exceeds 100, the oldest records are overwritten.

View OSS licenses

Click on "Click here for OSS information." under [Maintenance] - [System management], and the license of the OSS in use will be displayed.

Download root certificate

Click [Execute >] under "Download root certificate" in [Security] – [Communication] to download the root certificate.

Update the firmware

To update the firmware of the recorder to the latest version, proceed as follows.
Refer to page 74 for the operation procedures if the software is saved on the USB medium.

Step 1

Download the firmware of the latest version onto a hard disk drive of a PC.

Step 2

Click the [Maintenance] button and then click the [System management] tab.

Step 3

Designate the downloaded firmware by clicking the [Browse...] button of "Firmware update".

Step 4

Click the [Execute >] button.
→ The confirmation window will be displayed to start the update procedure.

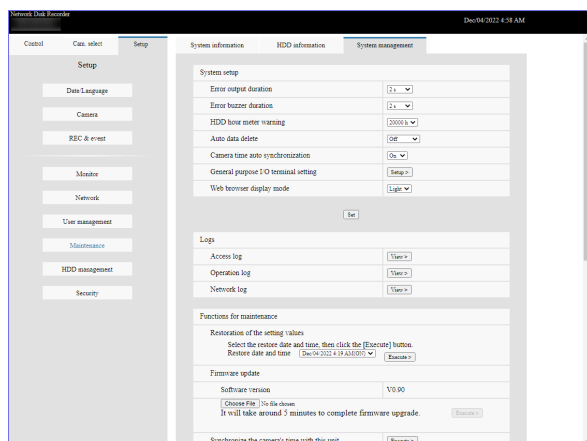

Note:

- Do not turn off the device or disconnect the network cable during the software upgrade.
- Contact your dealer for further information about the firmware update.

Notification by e-mail

Alarm mail

The recorder address are indicated in an alarm mail as follows.

Contents of the alarm mail (example)

In NWDR (192.168.0.250), alarm was occurred.

Occurrence date and time: xxxx-xx-xx xx:xx:xx GMT+xx:xx (Example. 2016-11-18 12:00:00 GMT+9:00)
Alarm descriptions: Alarm descriptions, camera channel or alarm number will be described.
(Example: SITE ALARM (Motion Det) CAM1 1ch)
URL: http://192.168.0.250/

Warning mail

The following mail will be sent to notify of a trouble occurrence to a registered address when the trouble occurs.

NWDR (192.168.0.250) Status notification
Occurrence date and time: xxxx-xx-xx xx:xx:xx GMT+xx:xx (Example. 2016-11-18 12:00:00 GMT+9:00)
Status: MAIN THERMAL ERROR

Indication	Description
Date & time	Date & time when the trouble occurred will be displayed.
Status	The description of the trouble will be displayed. xxx indicates the camera number, y indicates the HDD number or FAN number
	Thermal error: MAIN THERMAL ERROR
	HDD smart warning: MAIN-y SMART WARNING
	HDD slow response: MAIN-y SLOW RESPONSE
	HDD hour meter warning: MAIN-y HOUR METER WARNING
	Auto remove of link: MAIN-y LOGICALLY REMOVED
	Fan error: MAIN FANy ERROR
	NW camera error detection: CAM xxx COMMUNICATION ERROR
	NW camera error detection (audio): CAM xxx COMMUNICATION ERROR(AUDIO)
	NW camera error recovery: CAM xxx COMMUNICATION RECOVERED
	NW camera error recovery (audio): CAM xxx COMMUNICATION RECOVERED(AUDIO)
	Video loss detection (encoder): CAM xxx VIDEO LOSS
	Video loss recovery (encoder): CAM xxx VIDEO RECOVERED
	NW camera error detection (video): CAM xxx COMMUNICATION ERROR(VIDEO)
	NW camera error recovery (video): CAM xxx COMMUNICATION RECOVERED(VIDEO)
	NW camera error detection (live): CAM xxx COMMUNICATION ERROR(LIVE)
	NW camera error recovery (live): CAM xxx COMMUNICATION RECOVERED(LIVE)
	HDD remove error: MAIN-y SWAP WARNING
	Format error: MAIN-y SINGLE FORMAT ERROR
	Copy media FULL: COPY MEDIUM FULL
	Number of data on the copy medium exceeded: OVER LIMITATION ON COPY MEDIUM
	Starting mirroring recovery: MIRROR RECOVERY START
	Complete mirroring recovery: MIRROR RECOVERY COMPLETE
	Camera SD memory card error: CAM xxx SD ERR

Indication	Description
Status	Camera SD memory write start command error: CAM xxx SD START ERR
	Camera SD memory write completion command error: CAM xxx SD END ERR
	Camera SD Image acquisition failure: CAM xxx GET IMG ERR
	Camera SD Accumulated recording time warning: CAM xxx SD LIFE WARNING (LONG-TERM)
	Camera SD Overwrite warning: CAM xxx SD LIFE WARNING (OVER-REWRITTEN)
	Camera SD recording failure: CAM xxx SD RECORDING ERROR
	Camera SD Access error: CAM xxx SD ACCESS ERROR
	Camera SD memory card not recognized: CAM xxx SD MEMORY CARD NOT DETECTED
	Camera SD memory card capacity warning: CAM xxx SD MEMORY CARD CAPACITY WARNING
	Camera SD memory card full: CAM xxx SD MEMORY CARD FULL
	Camera failure (*): CAM xxx HARDWARE ERROR
	Exchange notification of wiper rubber of camera (*): CAM xxx REPLACE WIPER RUBBER
	* For WV-SUD638 camera only
	Changed angle: CAM xxx CHANGED FROM INSTALLATION ANGLE
	Recover angle: CAM xxx RECOVERED TO INSTALLATION ANGLE
	The trial period for the ext. software has expired: CAM xxx EXTENSION SOFTWARE TRIAL PERIOD EXPIRED
	HDD remaining capacity notice: HDD CAPACITY REMAINS **% ** indicates the percentage of remaining capacity
	Status HDD skip: MAIN-y HDD SKIP MAIN HDD SKIP
	PoE total power supply warning: PoE TOTAL POWER SUPPLY WARNING
	Stop PoE power supply: STOP PoE POWER SUPPLY
	Rollback: ROLLBACK

Troubleshooting

Before asking for repairs, check the symptoms with the following table.

Contact your dealer if a problem cannot be solved even after checking and trying the solution in the table or a problem is not described below.

Symptom	Cause/solution	Reference
Recording cannot be performed.	<ul style="list-style-type: none"> Is "On" is selected for "Recording mode"? Check whether the settings are appropriate. 	49
	<ul style="list-style-type: none"> Are the settings of the schedules appropriate? Check whether the settings are appropriate. 	42
Cannot play back images.	<ul style="list-style-type: none"> Are there any recorded images on the hard disk drives? Check if there are recorded images. 	77
	<ul style="list-style-type: none"> Users who have logged into the system may not be authorized to playback images recorded on the hard disk drives. Check the user level settings of these users. 	64
	<ul style="list-style-type: none"> Users who have logged into the system may not be authorized to display the images from cameras. Check the user level settings of these users. 	64
Audio is not output from the camera. Or audio is accompanied by noise.	<ul style="list-style-type: none"> Is the audio compression method of the camera compatible with this product? This product supports only "AAC-LC (64 kbps)" and "G.711 (32 kbps, when using ONVIF camera of other companies)". Check the setting of the connected camera. 	-
	<ul style="list-style-type: none"> Is other than "Selected camera" selected for "Audio output camera" in the "Monitor" - "Advanced setup" tab? Check whether the setting is appropriate. 	55
Cannot control the cameras.	<ul style="list-style-type: none"> Check whether the camera numbers and IP addresses that are displayed on the setup menu - the "Advanced setup" menu - the [Camera] page - [Camera registration] tab. 	13
	<ul style="list-style-type: none"> Check if the user name and password has correctly been entered on the setup menu - the "Advanced setup" menu - the [Camera] page - [Camera registration] tab. 	16
The message "Please insert a medium." is displayed even after an external storage device is inserted.	<ul style="list-style-type: none"> After the external storage device is inserted, it may take time to recognize the medium. Close the message window and wait for a while before retry. 	-

Symptom	Cause/solution	Reference
Cannot access from the web browser.	<ul style="list-style-type: none"> Is the Ethernet cable firmly connected to the 10BASE-T, 100BASE-TX, or 1000BASE-T port on the rear side? Confirm the cable is firmly connected. 	Installation Guide
	<ul style="list-style-type: none"> Is the connection indicator of the network port lit on the rear side? When it is not lit, connection to a LAN is not established or a network is not working correctly. Confirm that the connection indicator of the network port is lit. Refer to the system administrator if it is not lit. 	Installation Guide
	<ul style="list-style-type: none"> Is the valid IP address set? Refer to a system administrator for further information about the settings. 	56
	<ul style="list-style-type: none"> Are you accessing the wrong IP address? Check the connection by using a ping command from the PC command prompt as follows. >ping "IP address of this unit" If there is reply from this unit, the connection is normal. If not, check the settings of the IP address and the subnet mask. 	-
	<ul style="list-style-type: none"> Is the same IP address provided to other devices? Refer to a system administrator for further information about the settings. 	56
	<ul style="list-style-type: none"> Are there contradictions between the address and the network subnet to be accessed? When the recorder and the client (PC) are on the same subnet, is the same subnet set for the IP addresses of the recorder and the PC? Or is "Use Proxy Server" for the settings of the browser checked? When accessing the recorder in the same subnet, entering the address of the recorder in the "Don't Use Proxy For These Addresses" box is recommended. 	56
The image displayed on the browser is not being refreshed.	<ul style="list-style-type: none"> Depending on the traffic of the network, there might be difficulties in displaying images. Press the [F5] button on the keyboard to request images. 	-
Image refresh of the browser is slow. Response of the browser is slow.	<ul style="list-style-type: none"> Isn't the network traffic heavy? These symptoms may occur when the network traffic is heavy. 	-
Cannot close the authentication window displayed when displaying the operation window.	<ul style="list-style-type: none"> Are the correct user name and password entered? Confirm the correct user name and password. 	65
Audio is interrupted during playback using the viewer software.	<ul style="list-style-type: none"> When playing images recorded at a higher frame rate, audio may sometimes be played interrupted. 	-
Cannot play the downloaded recorded images.	<ul style="list-style-type: none"> When any setting of the setup menu has been changed during the download, the download will be canceled automatically. In this case, the downloaded file is not a complete file and it is impossible to play it. 	-

Symptom	Cause/solution	Reference
An error message is displayed when trying to launch the viewer software by dragging and dropping multiple files onto it.	<ul style="list-style-type: none"> Decrease the number of the selected files or select files after launching the viewer software. 	-
The external storage device is not recognized.	<ul style="list-style-type: none"> Is the connected external hard disk drive or USB memory compatible with USB 3.0 or 2.0? Is the external storage device formatted in exFAT, FAT (FAT16) or FAT32? If the capacity of the external storage device is 32 GB or less, the device must be formatted in FAT32. If it is 64 GB or more, the device must be formatted in exFAT. Is the external storage device equipped with the password authentication function? Is the connected hard disk drive run by USB bus power? The protection circuit function activates and the power supply will be stopped. Make sure to use the hard disk drive that runs using external power source. If the recorder is started up with a USB cable connected, in rare cases, the external storage device may not be recognized. Connect the cable after starting up the recorder. 	-
The live image or the playback image turns to the black screen on the web browser.	<ul style="list-style-type: none"> The PC memory may be insufficient. End the web browser and unnecessary software, launch the web browser again and then connect to the recorder. 	-
"SSL communication unavailable" was displayed in the connection error information on [Security] – [Communication] setting screen after selecting HTTPS for the connection with the camera.	<ul style="list-style-type: none"> Follow the procedures below. <ul style="list-style-type: none"> Click [Setup >] button of [Security between this product and camera] – [Connection] item on [Security] – [Communication] setting screen. Confirm that the connection of the camera is set to HTTPS and the port number to 00443. If the port number is wrong, set it to 00443. End the setting. If the problem is not solved, further perform the following procedures. <ul style="list-style-type: none"> Click [Security between recorder and camera] – [Connection] item button on [Security] – [Communication] setting screen and set the connection of the camera to HTTP. Click [Setup >] of [Registered information] on [Camera] – [Camera registration] setting screen. Confirm that the camera port number is set to 00080. If the port number is wrong, set it to 00080. End the setting and open the setting screen again. Click [Setup >] button of [Security between this product and camera] – [Connection] item on [Security] – [Communication] setting screen and reset the connection of the camera to HTTPS. 	-
The data size displayed in the copy panel differs from the data size which is actually copied.	<ul style="list-style-type: none"> The data size displayed in the copy panel is approximate. Errors will increase if audio data is recorded. Our network microphones in particular produce a large amount of data, so more errors tends to occur. Make sure to copy data to media with enough storage capacity. 	143

Symptom	Cause/solution	Reference
Copying progress can at times stop for a while at 99.9 %, or jump from 70 ~ 80 % to 100 %.	<ul style="list-style-type: none"> If the data of our network microphone is copied in original format, copying will continue even though progress remains at 99.9 %, as the calculation error of the audio data is large. Make sure to copy data to media with enough storage capacity. Meanwhile, the data are copied in MP4 format, the progress may suddenly change to 100 % and the copy may be complete as the audio data is not copied if not recorded in AAC-LC. 	143
MP4 files cannot be played on the general viewer. Only audio is played.	<ul style="list-style-type: none"> The general viewer may not support codec. In this case, use the viewer software of the recorder. 	178
The "Thermal error" indication is displayed on the main monitor.	<ul style="list-style-type: none"> The ambient operating temperature is 0 °C to +45 °C. The "Thermal error" is displayed based on the internal thermal information of the HDD. If the "Thermal error" indication is displayed, it is recommended to change the installation environment so that the ambient temperature is maintained at approx. +25 °C. When the "Thermal error" indication is displayed frequently, contact your dealer. 	Installation Guide
	<ul style="list-style-type: none"> Check if the fan is malfunctioning. 	97
	<ul style="list-style-type: none"> Check if the recorder ventilation holes or cooling fan are blocked, and also check for dust collected around the ventilation holes. 	Installation Guide
Mouse cursor does not display	<ul style="list-style-type: none"> Is the cable properly connected? Some mice may not be recognized. Please use the mouse included with the product. 	–
Audio communication errors and communication errors occur, camera images are not displayed, and video recording is not possible.	<ul style="list-style-type: none"> The camera's audio transmission mode may not be set correctly. Please confirm if the audio transmission mode setting is listening or bidirectional setting. In the status where the camera is connected, first switch the recording setting of this recorder to off, and return to (AAC-LC) On again to set it correctly. 	43
Camera live images are not displayed on the monitor as split screens, but are displayed as black images.	<ul style="list-style-type: none"> If "Target stream" is set to "Stream (2) & Stream (4)" for the target cameras in AI privacy guard settings, the H.264 (2) and H.265 camera resolutions become the same as those of H.264 (1) and H.265 (1). Accordingly, depending on the number of split screens, live images may not be displayed or playback may not be available. If you are not using AI privacy guard recording with this product, set "Target stream" in the AI privacy guard settings for the target cameras to something other than "Stream (2) & Stream (4)". 	16, 18, 115, 168

Symptom	Cause/solution	Reference
No image is displayed on the HDMI monitor.	<ul style="list-style-type: none"> • Does the HDMI output signal format match the specifications of your monitor? To fix the HDMI output signal format, set the signal format supported by the monitor. • Is an HDMI switcher used between this product and the monitor? It may not work properly depending on the specifications of the HDMI switcher. In addition, please use an HDMI switcher that supports bus-powered drive in a state where it operates with an external power supply for stable operation. • Is the cable in use compliant with the HDMI specifications? It may not work with a cable not compliant with the HDMI specifications. In addition, please use an HDMI cable of 5m or less in length to prevent deterioration of image quality and for stable operation. 	53, Installation Guide
The thumbnail image of the camera is displayed broken in the setup menu of the web browser.	<ul style="list-style-type: none"> • Check that the JPEG data encryption is not set to "On" in the camera setup menu. 	-
Camera settings do not match the monitoring system settings. The live image on the monitor is not displayed correctly. The camera does not notify alarms.	<ul style="list-style-type: none"> • [Camera] - [The functions of this product will not change the camera settings automatically] in [Advanced setup] is not checked. When this setting is checked, no camera settings are made. This may cause each function of the monitoring system to fail to operate properly. 	39
PoE power supply stopped.	<ul style="list-style-type: none"> • If the PoE power supply to the camera exceeds the power supply capacity of the IF1-WF01, the IF1-WF01 will stop PoE power supply. Reduce the number of cameras connected to the PoE power supply, and then click on the Error Resume button. Note that the PoE total power supply warning occurs when 80% of the power supply capacity is exceeded. 	-

Glossary

Bit rate

Indicates how many bits of data can be processed or transmitted in a unit of time. Generally, the units are in bps, or bits per second. Used to indicate the compression rate of video and audio data, and how much data a communications line can send and receive in 1 second.

Day & Night (IR/electrical)

Day & Night (IR) is a function to switch on black and white optically with an infrared filter inserted, and Day & Night (electrical) is a function to switch on black and white with the image processing of the camera.

Emergency recording

A function to prioritize image/audio recording using the external switch connected to the recorder for when emergencies occur.

Event

Indicates an occurrence that causes the recorder to take an event action. Events include terminal alarm, command alarm and camera site alarm, etc.

Event action

A specific action to be taken at an event occurrence. When "ALM" is selected, the occurrence of an event is announced by displaying a notification on the monitor, lighting the status indicators and sounding the buzzer. When "ADM" is selected, the occurrence of an event will not be announced and only recording and filing of event logs will be performed. Only an event log is filed when it is set to Off.

Event recording

Function for starting recording automatically when an event occurs. Event recording includes Pre-event recording that records images before the event and event recording that records images after the event.

Fisheye correction

This is a function to correct the fisheye image of our fisheye network camera to a 1-screen PTZ or 4-screen PTZ image.

Frame rate (ips)

Refers to the unit that determines the smoothness with which the recorded images are played back. "ips" indicates the number of recorded frames in 1 second. The higher the number, the smoother the movement, but the available recording time becomes shorter.

MJPEG

Indicates a video format to sequentially transmit JPEG images from cameras. Some cameras phrase this video codec as just "JPEG".

Multiscreen display

This product can display multiple camera simultaneously while displaying live images or playback images. Displaying of images from 4 cameras simultaneously is called as the 4-screen display.

TCP alarm notification

Sends a message to the registered address using our communication system when an event or error occurs. It is also used to receive the TCP alarm notification from the camera (camera site alarm) and operate event actions of the recorder.

Schedule recording

Function that automatically starts video and audio recording on a preset time schedule.

SD memory backup, SD memory data

The SD memory backup is a function of the camera to save images on the SD memory card inserted in the camera when the recorder fails to communicate with the camera during the set schedule. The SD memory data means its recorded image.

Smart coding (GOP control)

A control method of the camera to reduce the amount of the transmitted data by prolonging the refresh interval of the image when the motion in the image is little.

VMD (Motion detection) search

The function that automatically detects motion in images. In this product, it is possible to search for date & time of motion detection in recorded images.

Re-encoding transmission

When playing back recorded images in a web browser or application, this function re-encodes the recorded images to the resolution and frame rate supported by the respective application.

i-PRO Co., Ltd.

Fukuoka, Japan

<https://www.i-pro.com/>

Authorised Representative in EU:
i-PRO EMEA B.V.
Laarderhoogtweg 25, 1101 EB
Amsterdam, Netherlands



i-PRO EMEA B.V. UK Branch
1010 Cambourne Business Park,
Cambridgeshire CB23 6DP

