



Network Disk Recorder
WJ-NV200K



Security & AV Systems Business Unit
Panasonic System Networks Company

Product Concept

Turn analog CCTV market into IP market by SmartHD Package with Easy Operation & Value Price

Ease of Use Value Price High Definition
4 times higher resolution ECO

Hospitality, Retail stores, Franchise

Line up

WJ-NV200K (16ch)

Products launch

Oct-Dec 2010

1 month REC at 16ch, 6TB, 640x480 resolution, 30ips per camera, 24 hours REC

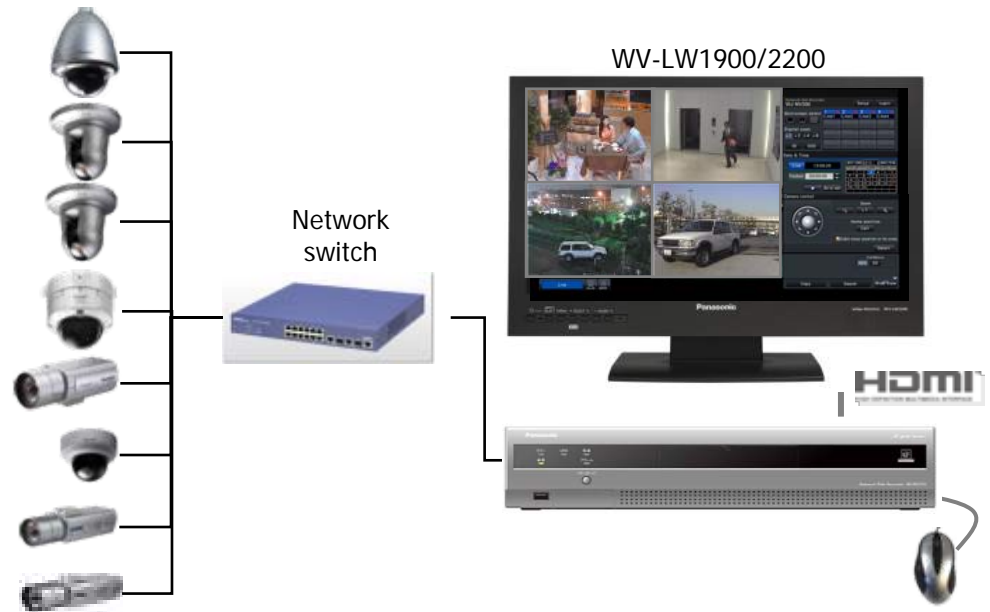

Product Outline

i-PRD
SmartHD



👉 One Click Search & Playback,
with Calendar & Timeline

👉 HDMI (Full HD) Output
(1,920x1,080)

👉 New "2U" Body
(300mm Depth)
-> Just Fit for Small Office/Store

👉 Easy Startup without
use of PC

Ease of Use

High Definition

4 times higher resolution

Panasonic ideas for life

Front Panel

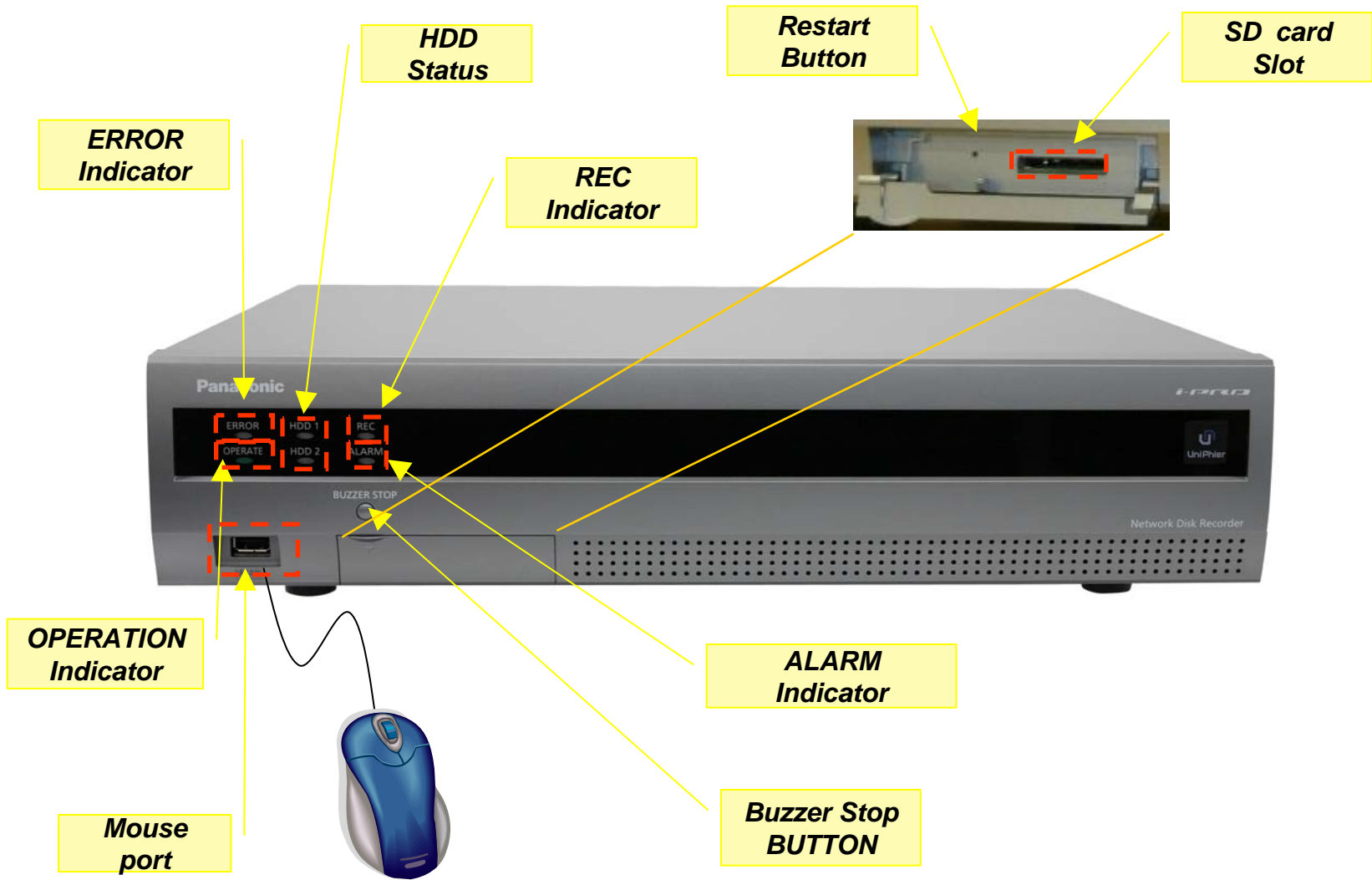

Rear Panel

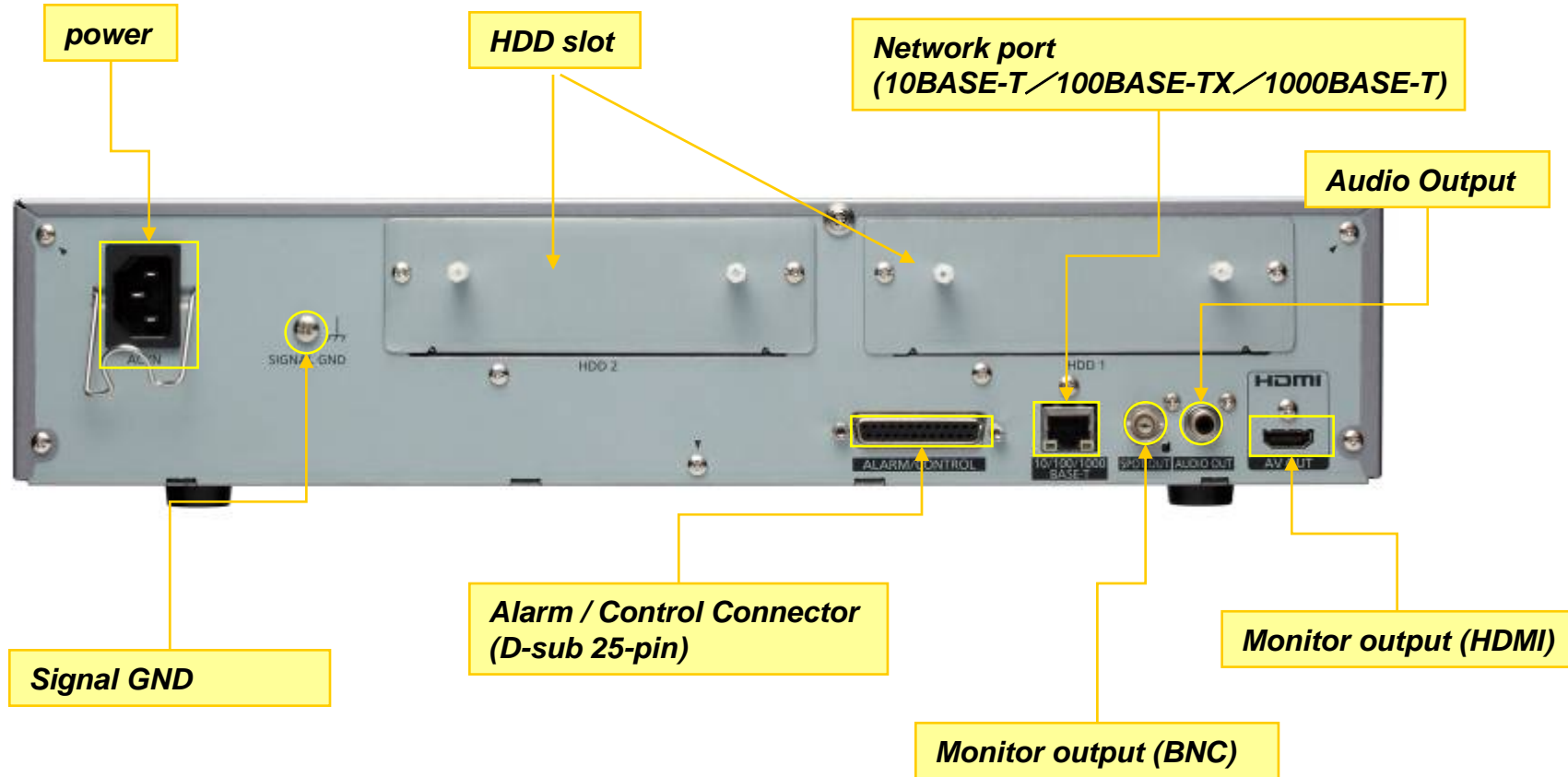

製品の定格及びデザインは、予告無く変更する場合があります。

Decoder built-in Network Disk Recorder

KEY FEATURES

- ◆ Quick Setup without use of PC
- ◆ Simple Operation by using mouse
- ◆ High Resolution Recording
- ◆ Full HD Monitoring
- ◆ ECO-friendly Back Light Control
- ◆ Support ONVIF compliant camera
- ◆ Real Time Face Matching



■ 1: Quick Setup without use of PC

Simple and easy set-up like analogue DVR

Quick Setup procedure for Recording

1. Connect Equipments with Cables
2. Power On All Equipments
3. Camera Detection & Recording Setup with a Wizard
4. Start Recording



No PC



PC-less

No Controller



Mouse / Simple GUI

H.264/MPEG4/JPEG

4 steps "Quick" setup for Recording

1. Date & time setup

Follow the wizard to set the basic settings.
<1> Set date & time of the recorder.
<2> Register the cameras to the recorder.
<3> Allocate the cameras to appropriate positions on the monitor.
<4> Set the recording settings.

<1> Set date & time of the recorder.

After setting date & time, click [Apply] button.

Date: **May 2010 / 5** AM: 10:00
MON TUE WED THU FRI SAT SUN
27 28 29 30 31 1 2
3 4 5 6 7 8 9
10 11 12 13 14 15 16
17 18 19 20 21 22 23
24 25 26 27 28 29 30
31

Apply

Next

Exit

2. Camera detection

<2> Register the cameras to the recorder.

1. After checking that the cameras and this product are connected to a switching hub, click the button corresponding to the search mode.
Search all the connected cameras **New** ← Auto detect button
Search only the added/replaced cameras **Addition**

2. Check that all the model numbers of connected cameras are being displayed.

Camera	Model	Results	Camera	Model	Results
1			9		
2			10		
3			11		
4			12		
5			13		
6			14		
7			15		
8			16		

3. Register the cameras by clicking the [Next] button.
· Assigns the IP addresses to the cameras automatically when the search result are "New", "Replaced" or "Added".
· When DHCP setting of a detected camera is effective, this unit invalidates DHCP setting, and IP address is given automatically.

Cancel Next

4. Recording setup

<4> Set the recording settings.

Recording setup (All cameras)

Frame rate: Low → High 5 ips ← Frame rate
Image quality: Low → High FQ ← Image quality
* The time marked with "*" are changed in the advanced setup.

Referenced recording days: **999 days**

* Using HDD saving mode, the actual recording days are longer than the referenced recording days.
* This value exclude the consumption of the event recording.
* This value is not displayed when non-Panasonic camera is connected.

Exit

Change the display position of camera

1. When dragging and dropping a camera segment from the camera position to the destination, the display positions of the two camera images are exchanged.

Also change camera titles

Display the image again when the [Refresh] button is clicked.

2. When configuring the recording settings, click the [Next] button. When completing the settings, click the [Exit] button.

Refresh Next Exit

Camera status

Camera	Model	Status
1		
2		
3		
4		
5		
6		
7		
8		
9		
10		
11		
12		
13		
14		
15		
16		

Camera positions change by "drag & drop" operation.

3. Camera position change

"Referenced recording days" is automatically calculated by frame rate, image quality and HDD capacity.

4 steps "Quick" setup for Recording

1. Date & time setup

Network Disk Recorder
WJ-NV200

Home

Quick setup

Start

Basic setup

Date/Language

Camera

REC & event

Advanced setup

Monitor

Network

User management

Maintenance

HDD management

Exit

Start

Follow the wizard to set the basic settings.

- <1> Set date & time of the recorder.
- <2> Register the cameras to the recorder.
- <3> Allocate the cameras to appropriate positions on the monitor.
- <4> Set the recording settings.

<1> Set date & time of the recorder.

After setting date & time, click [Apply] button.

Date: 2010 / 5 / 24

MON	TUE	WED	THU	FRI	SAT	SUN
					1	2
3	4	5	6	7	8	9
10	11	12	13	14	15	16
17	18	19	20	21	22	23
24	25	26	27	28	29	30
31						

Time: 15:30

Apply

Next

Date & time setup

4 steps "Quick" setup for Recording

2. Camera Detection

Network Disk Recorder
WJ-NV200

Home

Quick setup

Start

Basic setup

Date/Language

Camera

REC & event

Advanced setup

Monitor

Network

User management

Maintenance

HDD management

Exit

Start

<2> Register the cameras to the recorder.

1. After checking that the cameras and this product are connected to a switching hub, click the button corresponding to the search mode.

Search all the connected cameras **New**

Search only the added/replaced cameras **Addition**

2. Check that all the model numbers of connected cameras are being displayed.

Camera	Model	Results
1		
2		
3		
4		
5		
6		
7		
8		

Camera	Model	Results
9		
10		
11		
12		
14		
15		
16		

3. Register the cameras by clicking the [Next] button.

- Assigns the IP addresses to the cameras automatically when the search result are "New", "Replaced" or "Added".
- When DHCP setting of a detected camera is effective, this unit invalidates DHCP setting, and IP address is given automatically.

Cancel Next

Camera Searching

Searching Result

4-step "Quick" setup for Recording

3. Camera Position Change

The screenshot displays the camera management interface. At the top, three camera preview windows show different views of a store. Below them is a 4-camera grid. A yellow callout box with two white arrows pointing to the top-left and top-right cells of the grid contains the text: "Camera position change by 'drag & drop' operation." To the right, a dialog box titled "Change the display position of camera" is open. It contains the following text:

1 When dragging and dropping a screen segment from the current position to the destination, the display positions of the two camera images are exchanged.

Also change camera titles

Displays the image again when the [Refresh] button is clicked.

2 When configuring the recording settings, click the [Next] button. When completing the settings, click the [Exit] button.

Buttons: Refresh, Next, Exit

Camera status

Camera	Model	Status
1		
2		
3		
4		
5		
6		
7		
8		
9		
10		
11		
12		
13		
14		
15		
16		

Setup

4-step "Quick" setup for Recording

4. Recording Setup

Network Disk Recorder
WJ-NV200

Start

<4> Set the recording settings.

Recording setup (All cameras)

Frame rate	1	3	5	10	15	30	High	5 ips
Image quality	Low	NQ	FQ	SF	High	FQ		

* The itme marked with "*" are changed in the advanced setup.

Referenced recording days

999 days

* Using HDD saving mode, the actual recording days are longer than the referenced recording days.
* This value exclude the consumption of the event recording.
* This value is not displayed when non-Panasonic camera is connected.

Frame Rate setup

Image Quality setup

"Referenced recording days" is automatically calculated by frame rate, image quality and HDD capacity.

WJ-NV200K Features

■ 2: Simple Operation (Live Viewing)

Simple operation with New GUI

High-definition, dot-by dot image display



Easy & Intuitive Operation with Mouse
- 1 from/to 4 Picture Change by One Click
- Click Centering
- Zoom with Mouse Wheel Rotation

Menu Area
Buttons for main functions are always displayed.
Required information is also always displayed

Menu Area by Function
Required menu is only displayed
Ex.) Live Viewing / Search & Playback / Copy

WJ-NV200K Features

■ 2: Simple Operation (Search & Playback)

Quick intuitive search with calendar and time line

Only by clicking calendar & timeline, recorded image will be playback.

Menu for Playback

Calendar

Timeline

VMD information is visually displayed on timeline.

The screenshot shows a 4-camera view of a store. The control panel includes a 'Live' view at 15:38:56, a 'Playback' view at 00:00:00, and a 'REC Event' view. The calendar shows the date 2010/6/15. The timeline shows a 24-hour period with VMD information displayed as vertical bars. The control panel also includes a 'Menu for Playback' and a 'Timeline' section.

■ 3: High Resolution Recording

Beyond current analog picture quality
Full digital SXVGA (1,280x960), Much better identification

Original picture view of angle

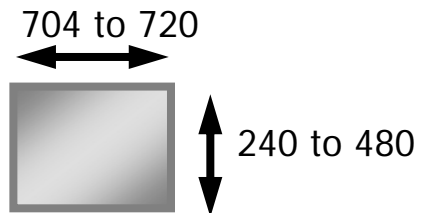

Analog
170k to 340k pixels

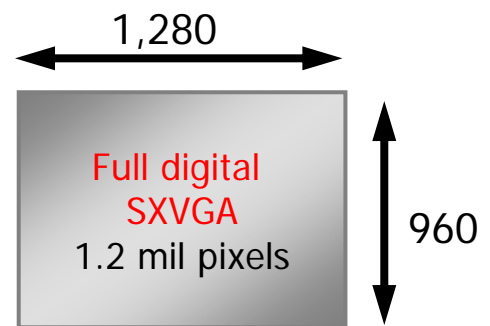

Full digital
SXVGA
1.2 mil pixels

WJ-NV200K Features

4: Full HD Monitoring

Dot by dot display of SXVGA image

The screenshot displays the WJ-NV200K monitoring software interface. On the left, a live video feed shows a man in a suit walking through a hallway. A pink rectangle highlights a portion of the video. The video dimensions are indicated as 1080 (height) and 1280 (width). The control panel on the right includes a 'Multiscreen select' section with four camera buttons (CAM1-CAM4), a 'Digital zoom' section with buttons for x1, x2, x4, and x8, and a 'Date & Time' section with a calendar. The bottom of the interface features a 'Copy' button, a 'Search' button, and a 'Wide view' dropdown menu.

1920

■ 5: ECO-friendly Back Light Control

Automatically control back light of Panasonic's LW series monitor

When mouse is not operated for a while, back light of Panasonic's LW series monitor is controlled to decrease the power consumption by switching its mode from normal to ECO1 or ECO2.

e.g. LW2200 Power consumption reduction

Normal:51W -> ECO1(Low light) : 29W (-43%)

Normal:51W -> ECO2(Black) : 13W (-74%)

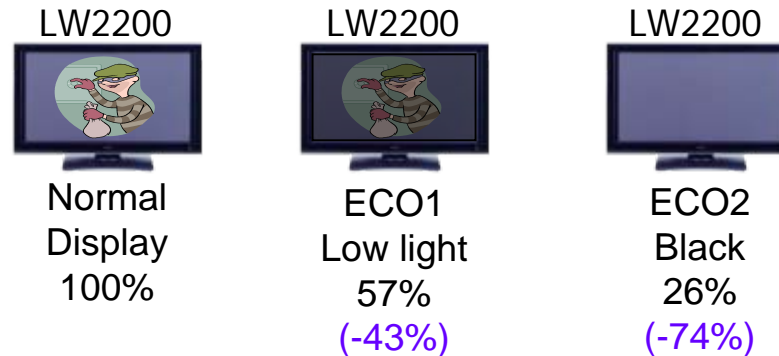

*The duration of mode switch is about 1 second.

■ 6: Support Onvif compliant camera

Support Onvif compliant camera I
n addition to wider range of Panasonic camera

Onvif camera support schedule

◆ Support only camera discovering (Oct / 2010)

*Onvif version 1.0 doesn't support recording I/F between cameras and recorders

◆ Support recording (1Q/2011)

*This schedule is depending on the progress of Onvif Standard

7: Real Time Face Matching

NV200K provides Real Time Face Matching capability in conjunction with SmartHD camera

(1) SmartHD camera automatically detect human face and send its information as a XML data.



(2) NV200 matching the face.

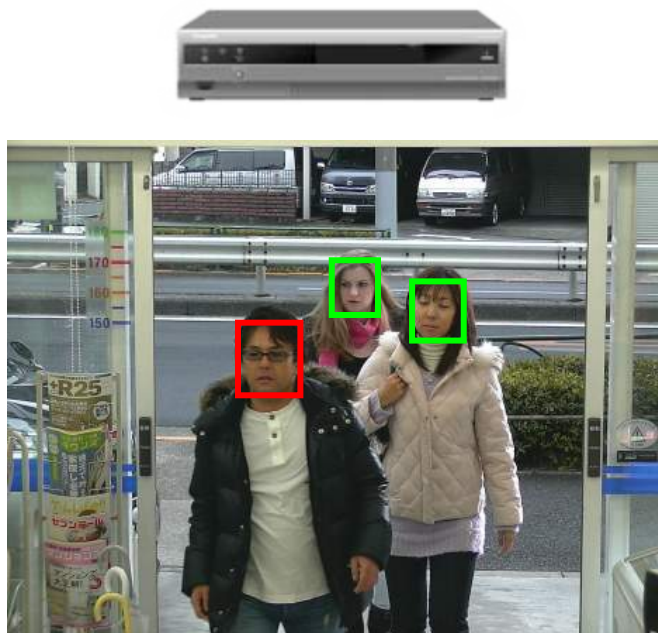

(3) Alarm occur if the face match with registered face



*In Actual image processing, the rectangular would not be appeared.

**Please refer "NV200_face_matching_introduction" in more detail.*

Basic Configuration and Operation

Basic Configuration



- SW395(New)
- SC385(New)
- NW502
- NP502
- SF330s(New)
- SP300s(New)
- SP100s(New)
- BB camera

Analog
Cameras



HUB

GXE500(New)



Powered
Speaker

Mouse

WJ-NV200K

copy

SD (SHDC)

Not support Extension Unit and controller



WV-LW1900/2200



HDMI

Spot



Internet Explore







BNC

Network



WV-ASM100/ASM100L

Operation/Setup Methods

	Mouse 	Web Browser 	ASM100 	i-PRO Config. tool 
Operation	Yes	Yes	Yes (*Jan/2011)	N/A
Setup	Yes	N/A	N/A	Yes (*Jan/2011)

Video Output specification

i-PRRO
SmartHD

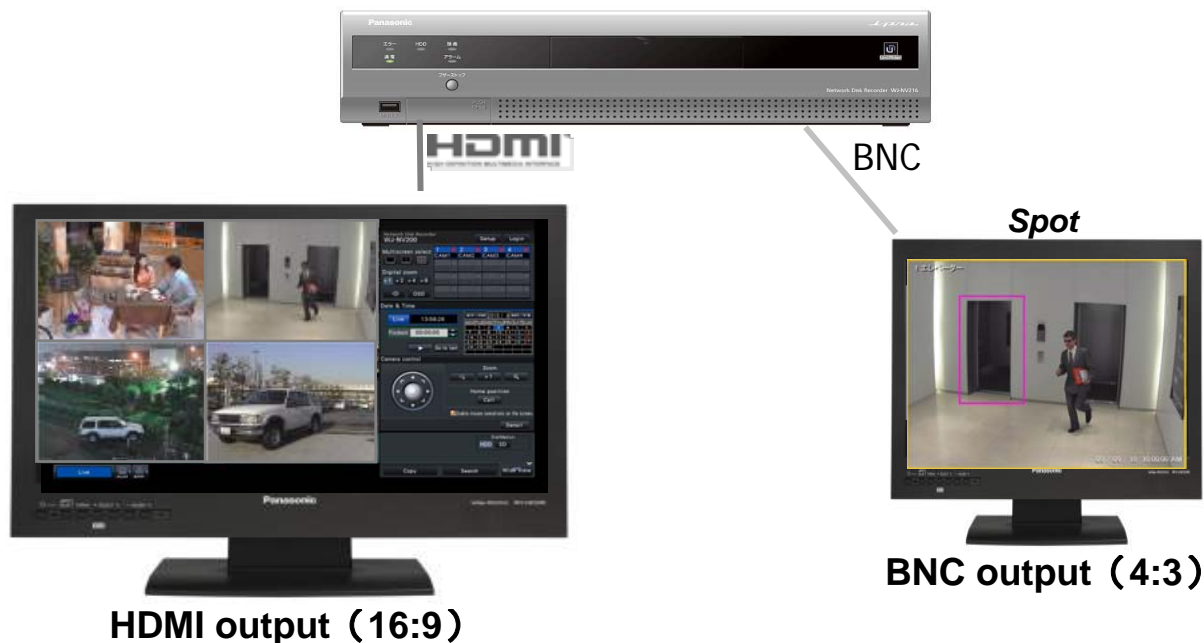

Supported Resolutions for HDMI input

- ◆ 1920 x 1080 /60i (NTSC) (16:9)
- ◆ 1920 x 1080 /50i (PAL) (16:9)
 - 720 x 480 /60p (NTSC) (4:3)
 - 720 x 576 /50p (PAL) (4:3)



Please make sure that monitor supports HDMI 1080i mode.

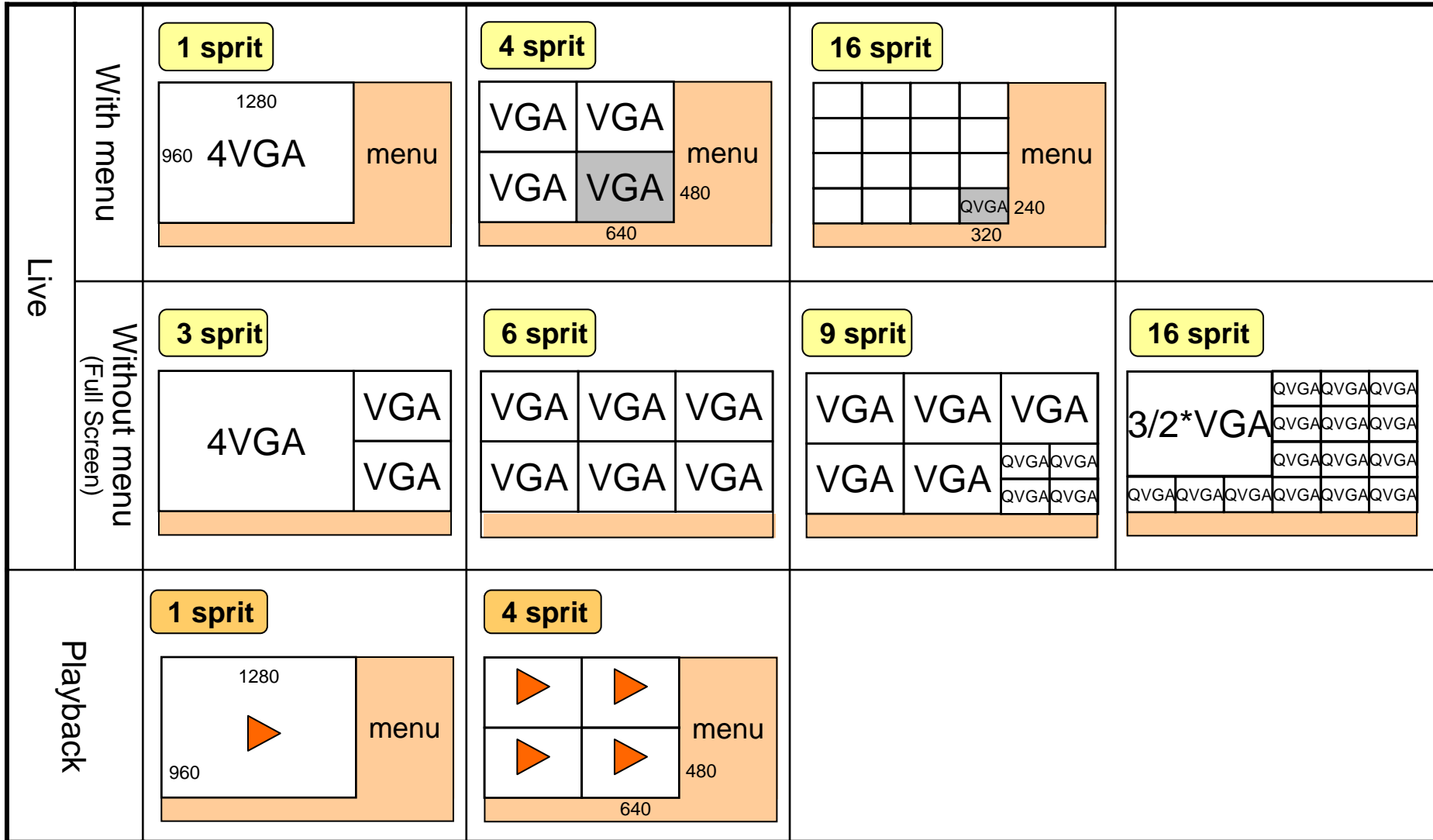

Spot Monitor specification

Live monitoring or Sequence functions with 1 screen is available

Spot Monitor is independent from HDMI monitor
No multi screen for spot monitor
Setup menu is not displayed on Spot monitor

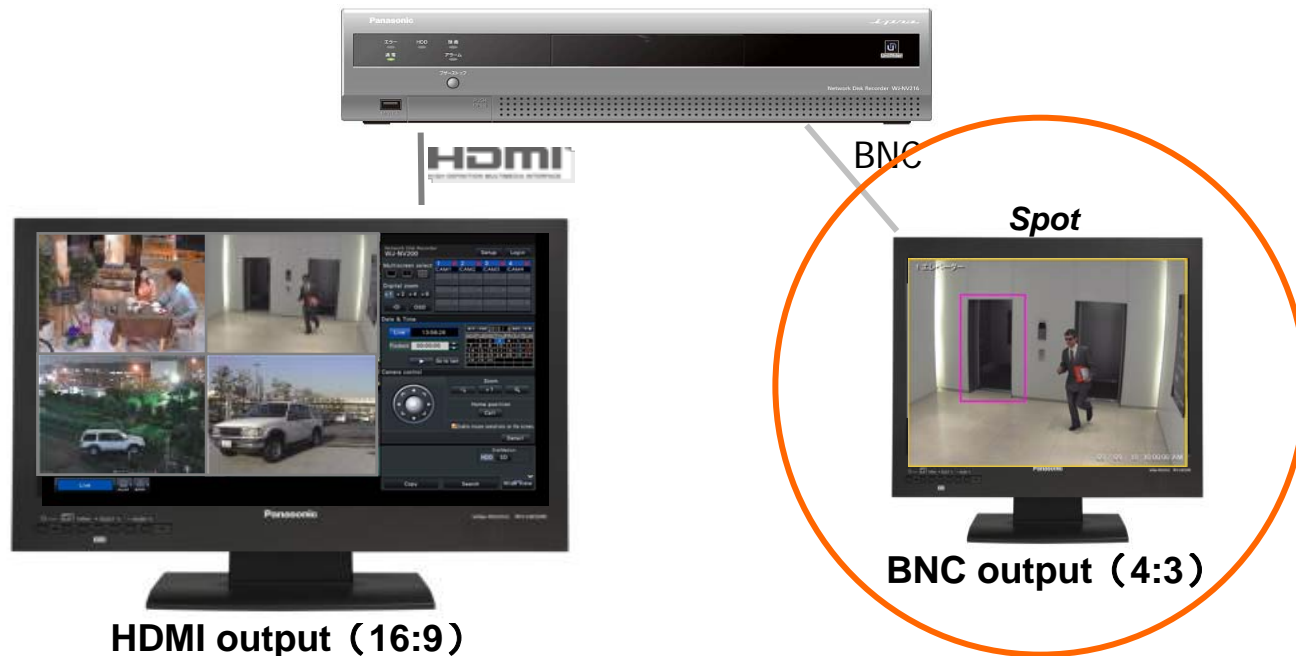

Co-operation Functions with i-PRO Cameras

NV200 has three superior functions with i-PRO cameras.

(1) Face Matching

Thanks to a face detection function of i-PRO cameras, NV200 provides a face matching function. Please see “NV200 Face Matching Outline” chart, for further details.

(2) Easy setup of VMD search

Thanks to a VMD info transmission from i-PRO cameras, NV200 provides a VMD search function like ND400.

In addition, NV200 can set up VMD info transmission of all supported i-PRO cameras automatically.

(3) Flexible Recording Settings with Smooth Live Viewing

Thanks to a multiple video stream function of i-PRO cameras, different resolutions, frame rates or image quality of videos are separately-applicable on each recording or live viewing. This enables NV200 to display most suitable and smoothest live images by being independent from recording video stream.

NV200

Panasonic original function "VMD search" is available.
NV200 requests **all** supported i-PRO cameras to turn the setting of VMD info transmission "ON" **automatically**.

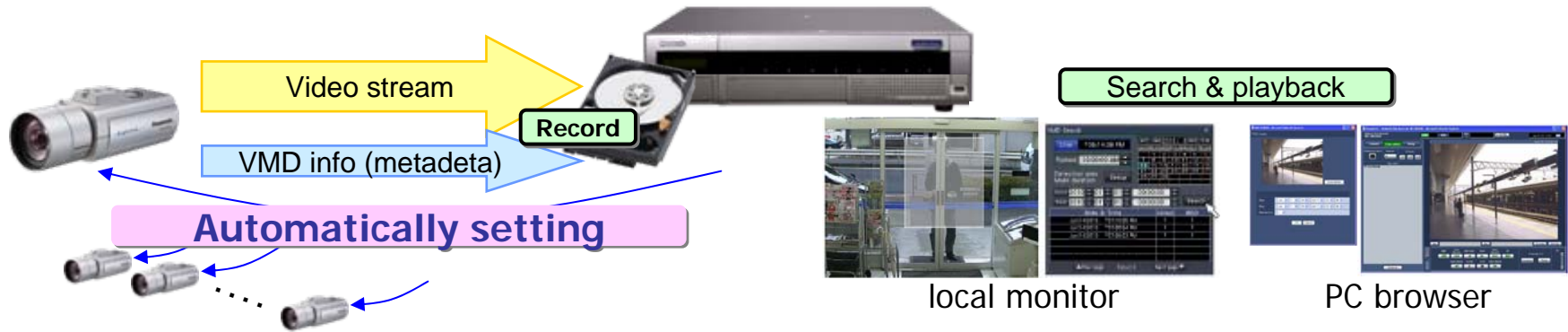

Flexible Recording Settings with Smooth Live Viewing

NV200

- NV200 uses the 1st stream of i-PRO camera for recording and the 2nd stream for live viewing.
- The various setting of recording is selectable
- The setting of live viewing is automatically decided by NV200 depending on display pattern.
- >NV200 provides **flexible** recording setting with **smooth** live viewing.



Flexible Recording Settings with Smooth Live Viewing

Note1: The difference of recording and live viewing capability



NV200



**NP502
NW502**

1st stream
Up to **SXVGA/30fps @H.264**

2nd stream
Up to **SXVGA/15fps @H.264**

<Recording>
SXVGA/VGA/QVGA
1fps/3fps/5fps/10fps/15fps/30fps
SF/FQ/NQ

<Live viewing>
SXVGA 15fps (@1 screen)
VGA 30fps (@4 screens)
QVGA 10fps (@16 screens)



**SP306/305
SF336/335
SC385
SP105**

1st stream
Up to **SXVGA/30fps @H.264**

2nd stream
Up to **VGA/30fps @H.264**
These cameras can't support SVGA resolution for the 2nd stream.

<Recording>
SXVGA/VGA/QVGA
1fps/3fps/5fps/10fps/15fps/30fps
SF/FQ/NQ

<Live viewing>
VGA 30fps (@1 screen) *twice magnification
VGA 30fps (@4 screens)
QVGA 10fps (@16 screens)



**SP302
SF332
SP102**

1st stream
Up to **VGA/30fps @H.264**
These cameras can't support SVGA resolution.

2nd stream
Up to **VGA/30fps @H.264**
These cameras can't support SVGA resolution.

<Recording>
VGA/QVGA
1fps/3fps/5fps/10fps/15fps/30fps
SF/FQ/NQ

<Live viewing>
VGA 30fps (@1 screen) *twice magnification
VGA 30fps (@4 screens)
QVGA 10fps (@16 screens)

Flexible Recording Settings with Smooth Live Viewing



HCM705/715/735

1st stream

Up to SXVGA/30fps @H.264



NV200

<Recording>

SXVGA/VGA/QVGA

1fps/3fps/5fps/10fps/15fps/30fps

SF/FQ/NQ

<Live viewing>

- The same resolution & image quality as recording.

(*Magnified or reduced depending on display pattern)

- The same frame rate as recording rate or less.

(*Depending on display pattern)



HCM701
GXE500

1st stream

Up to VGA/30fps @H.264

<Recording>

VGA/QVGA

1fps/3fps/5fps/10fps/15fps/30fps

SF/FQ/NQ

<Live viewing>

- The same resolution & image quality as recording.

(*Magnified or reduced depending on display pattern)

- The same frame rate as recording rate or less.

(*Depending on display pattern)

* NV200 recognize GXE500 as a single stream camera because GXE500 has the dual stream transmitting capability but 1st stream and 2nd stream is the same.

Flexible Recording Settings with Smooth Live Viewing

Note2: The Bit rate chart of recording

<Kbps>

1 st stream for recording		NP502/NW502/GXE500 @H.264						SP30x/SF33x/SP10x/SC385 @H.264						BB-HCM7xx @H.264					
Resolution	Image Quality	Frame rate (fps)						Frame rate (fps)						Frame rate (fps)					
		1	3	5	10	15	30	1	3	5	10	15	30	1	3	5	10	15	30
QVGA 320x240	SF	256	512	512	768	768	1024	256	512	512	768	768	1024	256	256	256	384	512	768
	FQ	128	256	256	384	384	512	128	256	256	384	384	512	256	256	256	384	512	768
	NQ	64	128	128	256	256	384	64	128	128	256	256	384	256	256	256	384	512	768
VGA 640x480	SF	768	1024	1024	1536	1536	2048	512	768	768	1024	1024	1536	512	512	512	768	1024	1536
	FQ	384	512	512	768	768	1024	256	384	384	512	512	768	512	512	512	768	1024	1536
	NQ	256	384	512	512	512	768	256	256	256	384	384	512	512	512	512	768	1024	1536
SXVGA 1,280x960	SF	1536	2048	2048 (4096*)	3072	3072	4096	1536	2048	2048 (4096*)	3072	3072	4096	1024	1024	1024	1536	2048	3072
	FQ	768	1024	1024	1536	1536	2048	768	1024	1024	1536	1536	2048	1024	1024	1024	1536	2048	3072
	NQ	256	512	768	1024	1024	2048	256	512	768	1024	1024	2048	1024	1024	1024	1536	2048	3072

		All cameras and encoders @MPEG4					
QVGA 320x240	SF	256	256	512	512	2048	4096
	FQ	128	128	256	512	1024	3072
	NQ	64	128	128	256	512	2048
VGA 640x480	SF	384	512	1024	1536	2048	4096
	FQ	384	512	512	1024	1536	3072
	NQ	256	384	512	1024	1024	2048

- This table shows the bit rate by the combination of the recording setting for resolution/frame rate and image quality.
- Bit rate is automatically decided by the setting for resolution/frame rate and image quality in NV200. No need to set bit rate.
ex) When H.264/SXVGA/FQ/30fps is set for NP502 recording, video stream at 2,048kbps is transmitted from NP502 to NV200.
- NV200 receive the video stream from cameras at frame rate priority mode.
- (4096*) is the bit rate when the camera is used for face matching.

Setup procedure

3 steps flexible recording schedule setup

1. Recording days of the week
2. Recording periods of the day
3. Frame Rate / Image Quality / Audio with checking recording days

*Camera settings such as frame rate and image quality are automatically configured by NV200

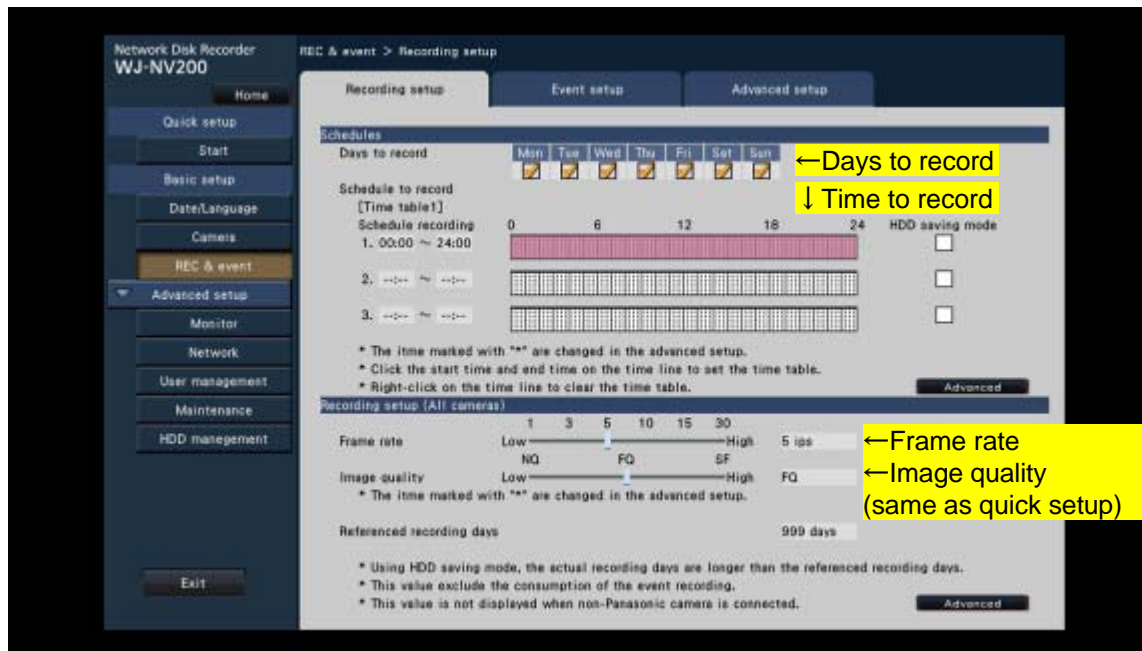

*More flexible recording schedule is available in advanced menu.

Camera registration Setup

Manually Camera registration setup chart

i-PRO Camera

classification	Registration camera model
i-PRO1(A)	NF28*, NF302, NP24*, NP304, NS202A, NS95*, NW96*
i-PRO1	NW484
i-PRO2_HD(A)	NP502, NW502, SF335, SF336, SP305, SP306, SC385, SW395
i-PRO2_Std(A)	SF332, SP302
i-PRO2a_HD	SP105
i-PRO2a_Std	SP102
i-PRO2_Enc1(A)	GXE500 *Ch1 with audio
i-PRO2_Enc1	GXE500 *Ch1 without audio
i-PRO2_Enc2	GXE500 *Ch2
i-PRO2_Enc3	GXE500 *Ch3
i-PRO2_Enc4	GXE500 *Ch4

BB Camera

classification	Registration camera model
BB1	HCM100, HCM110, HCM371
BB2	HCM511, HCM527, HCM547, HCM580, HCM581
BB3_Std(A)	HCM701
BB3_HD(A)	HCM705, HCM715, HCM735

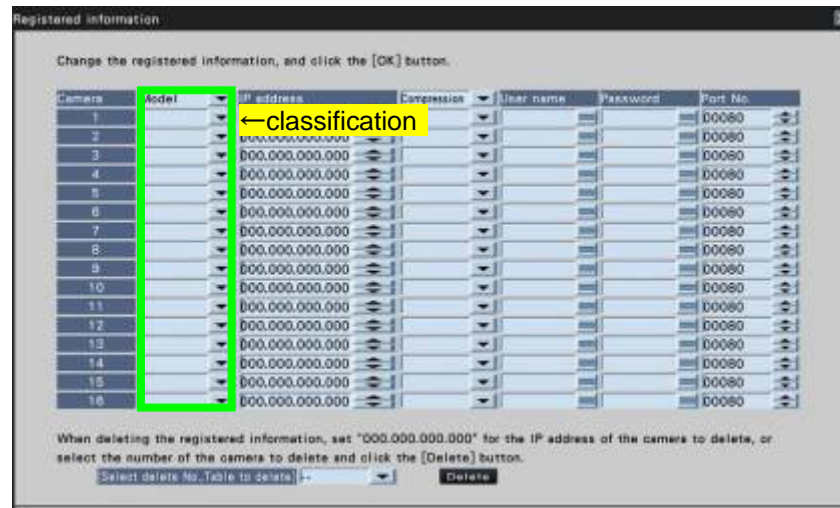

AXIS camera

classification	Registration camera model
AXIS1_Std	210, 23*D
AXIS1_Std_M	210, 23*D
AXIS1_Enc1	241S, 241Q
AXIS1_Enc1_M	241S, 241Q
AXIS1_Enc2	241Q
AXIS1_Enc2_M	241Q
AXIS1_Enc3	241Q
AXIS1_Enc3_M	241Q
AXIS1_Enc4	241Q
AXIS1_Enc4_M	241Q

Onvif

classification	Registration camera model
ONVIF1	1Q/2011
ONVIF1(A)	1Q/2011
ONVIF2	1Q/2011
ONVIF2(A)	1Q/2011

Network Features

Number of the sessions opened by PC equal or less than 2.

The order of disconnection is decided by the priority.

- If 3rd session is being connected, the lowest priority session is disconnected.
- If there are more than one lowest priority sessions including 3rd session, the latest session is canceled.

- ◆ 1 Web Connection : Counted as 1 session
- ◆ ASM100 Connection
 - Single Monitor use : Counted as 1 session.
 - Multi monitor use: Counted as 2 sessions.
- ◆ ASM100L Connection : Counted as 1 session.

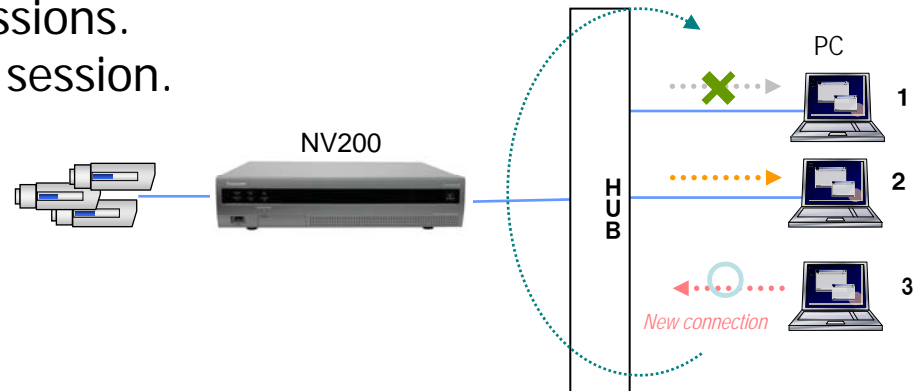

The basic control operation is available on Web browser

Recorder Control operation

Date	Cam	Evt	HDD	Audio
2010-06-07 13:00:30	1	SCH	1	🔊
2010-06-07 13:00:30	2	SCH	1	🔊
2010-06-07 13:00:30	3	SCH	1	🔊
2010-06-07 13:00:30	4	SCH	1	🔊
2010-06-07 13:00:30	5	SCH	1	🔊
2010-06-07 13:00:30	6	SCH	1	🔊
2010-06-07 13:00:30	7	SCH	1	🔊
2010-06-07 13:00:30	8	SCH	1	🔊
2010-06-07 12:25:31	8	SCH	1	🔊
2010-06-07 12:00:30	1	SCH	1	🔊
2010-06-07 12:00:30	2	SCH	1	🔊
2010-06-07 12:00:30	3	SCH	1	🔊
2010-06-07 12:00:30	4	SCH	1	🔊
2010-06-07 12:00:30	5	SCH	1	🔊
2010-06-07 12:00:30	6	SCH	1	🔊
2010-06-07 12:00:30	7	SCH	1	🔊

Camera or Recorder Control operation

*The setup operation is not available on Web browser.

Copy Recorded Images

It is possible to manually copy images recorded in the recorder onto an SD/SDHC memory card.

Step1

Insert an SD/SDHC memory card into the recorder.
(Formatting of SD card is required for the first use. Refer to page 4)

Step2

Click the [Copy] button on the operation panel of the main monitor.
The copy panel will be displayed (if in playback mode, playback will be paused).

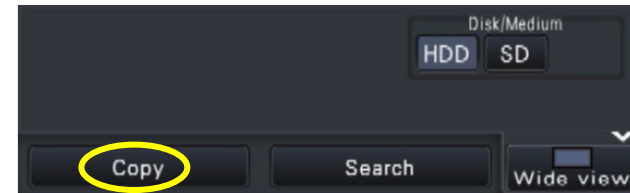

Step3

The following items can be set up for copying of recorded data:

Item	Description
(1) Camera selection	Check the number of the camera whose recorded data is to be copied. Checking [Check all] will copy the recorded data of all cameras.
(2) Copy drive	Indicates the copy destination.
(3) Date & Time range	Specify times and dates to define the range for copying recorded data. Set the year, month, date and time of the start point and end point. Specify the time and date for copying to start/end by clicking the [Start]/[End] button.
(4) Assign a password	Check this item to assign a password to the copied data. The password will be required to play back copied data that is password protected.
(5) Free	The remaining space of the storage medium will be displayed.
(6) Data size	The total volume of all recorded images to be copied (including the viewer software) will be displayed. * Indicated as *.* GB while the data volume is being calculated.



Step4

Click the [Copy] button on the copy panel.

If the [Assign a password] checkbox has been marked, the password entry screen will be displayed.
Otherwise proceed to Step 6.

Step5

Enter the password, and then click the [Next] button.

- Enter 5 to 8 alphanumeric characters for a password.
- To confirm the password, enter the same password again into the "Retype" column.
- To save the entered password, check "Memorize password temporarily". The next time data is copied, the password entry window will open with the password already filled in. The password will be retained in memory until the power of the recorder is turned off
→ The copy start confirmation window will be displayed.

Step6

Click the [OK] button in the copy start confirmation window.

→ "Copying" is displayed in the status display area, and copying will start. When copying is completed, "Copying" will go off.

Input password

Password

Password (Retype)

A	B	C	D	E	a	b	c	d	e	1	2	3	4	5
F	G	H	I	J	f	g	h	i	j	6	7	8	9	0
K	L	M	N	O	k	l	m	n	o					
P	Q	R	S	T	p	q	r	s	t					
U	V	W	X	Y	u	v	w	x	y					
Z					z									

← → Delete

Memorize password temporarily

Back Next

Format SD/SDHC Memory Card

To copy recorded images on SD/SDHC memory card, the SD/SDHC memory card first needs to be formatted. Note that formatting the SD/SDHC memory card will delete all data stored on it.

Step1

Click the [Copy] button on the operation panel of the main monitor.
→ The copy start confirmation window will be displayed.

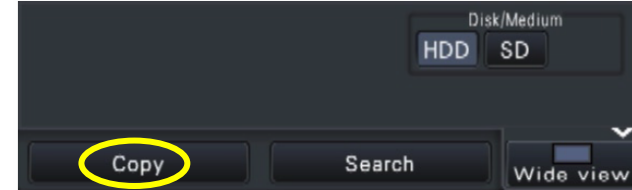

Step2

Click the [Advanced] button.
→ The "Advanced setup" window will be displayed.

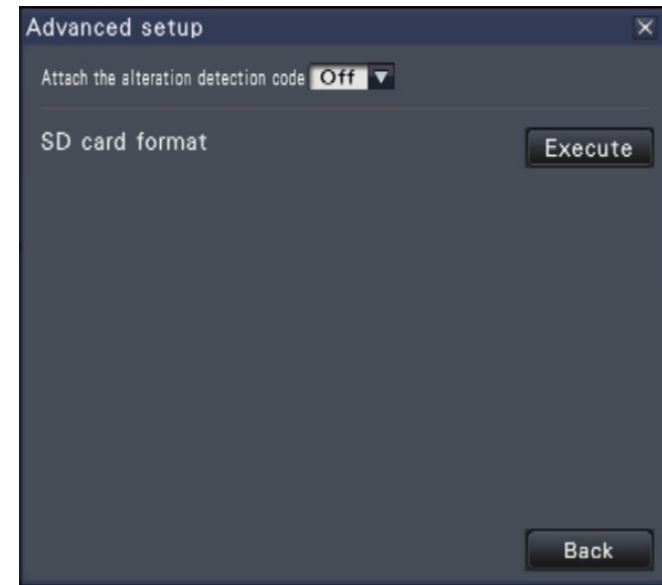

Step3

Click the [Execute] button for "SD card format".
→ The confirmation window will be displayed.

Step4

Click the [OK] button.
→ Formatting of the SD memory card will start, and a window indicating that formatting is in progress will be displayed.
When formatting is completed, the format completion window will be displayed.

Install-less Viewer

Double-click the exe file (ND_Viewer.exe) on the SD memory card to run the viewer software.

The viewer is copied in the following folder together with recorded images.

Folder -> [Drive]: /PRIVATE /MEIGROUP /PSS /NVR /ND_Viewer

***No install operation is required to use this viewer.**

***Note that install operation is required like conventional NVR's when a viewer is downloaded on PC browser.**

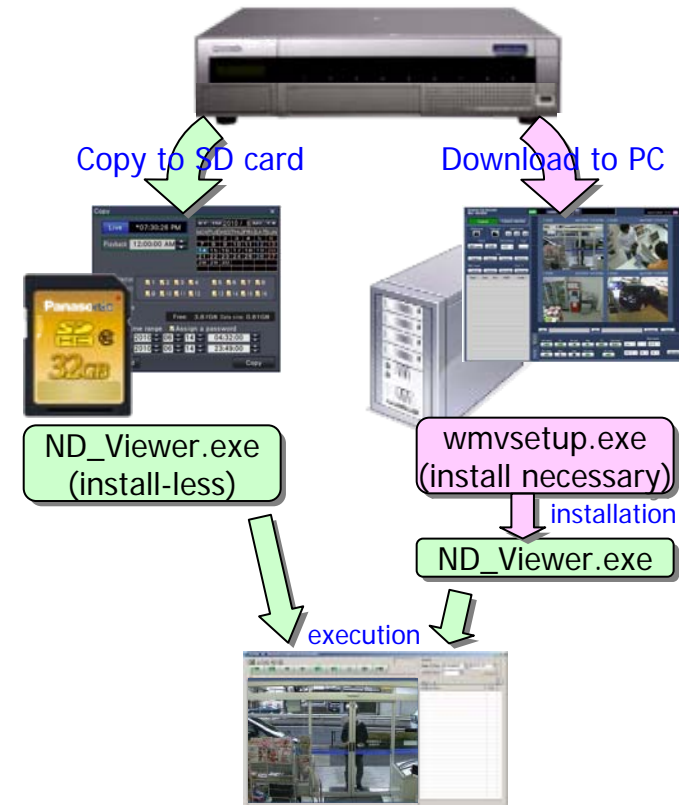
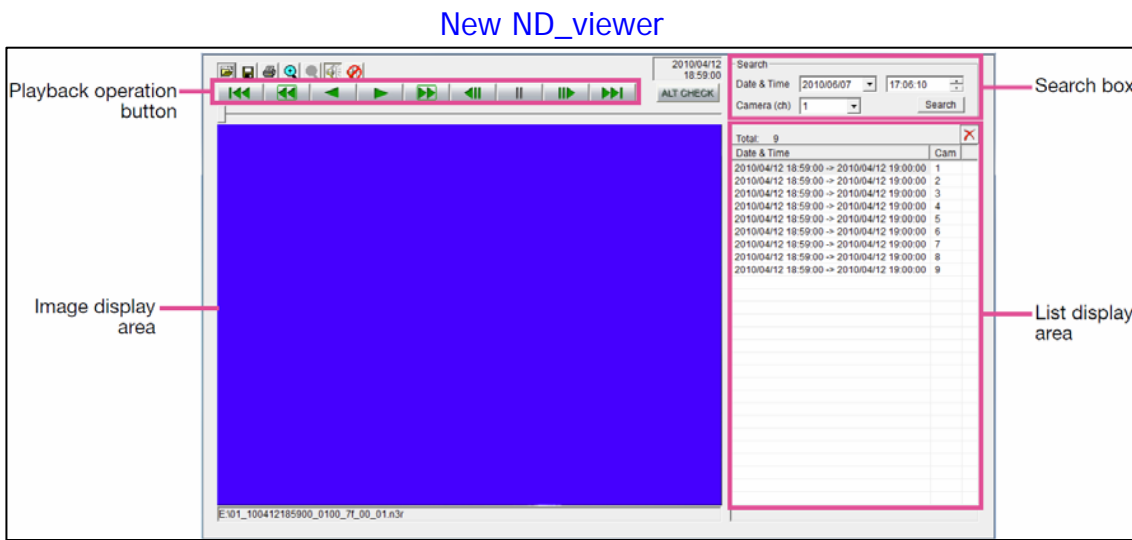

*Downloaded video from ND200, ND300, ND400 and HD616/716 is available as well.

When video data is copied to SD, or downloaded to a PC or transmitted to FTP server, it is possible to specify whether or not Alteration Detection code is attached. When the Alteration Detection code has been attached, the viewer software (ND Viewer) can detect the alteration of the data.

Operation of ND Viewer for the download images is as follows.

- Launch the viewer software, then click the open file button.
- Select the file to be viewed, then click the open button.
- The first frame of image data will be displayed and paused.
- Click the [ALT CHECK] button.
- Alteration detection will start.
- The [ALT CHECK] button is displayed only when Alteration Detection code is attached.
- [OK (Not Altered)] or [NG (Altered)] is displayed as the result.

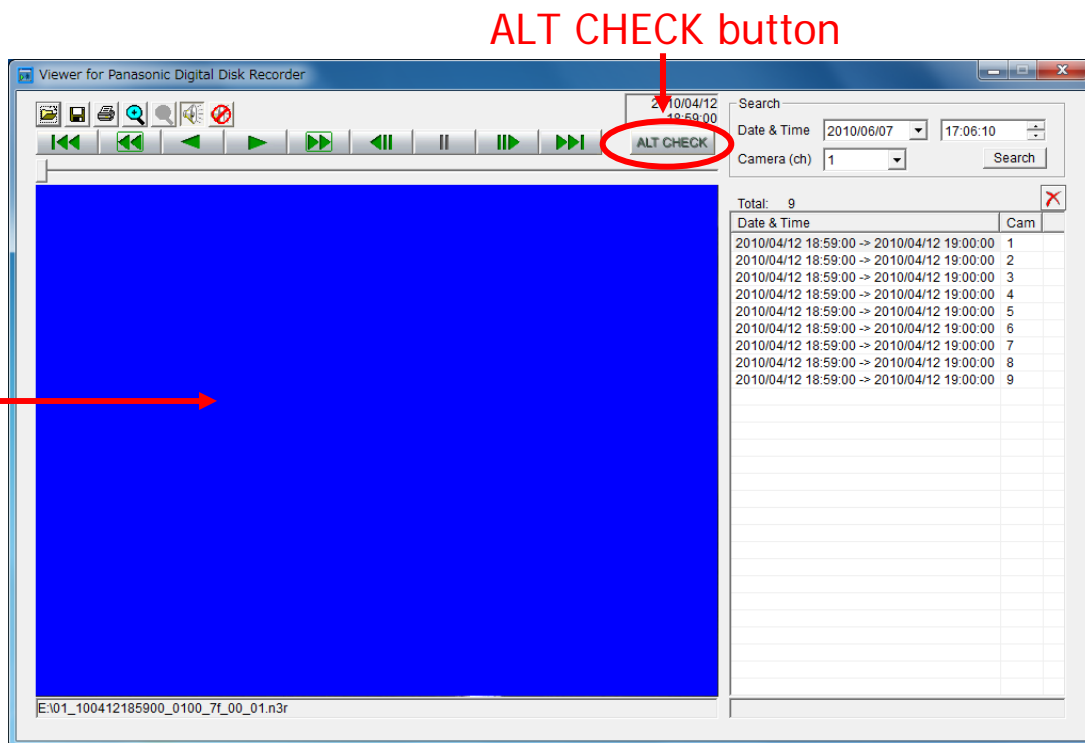

PC Requirements

The following are Recommended PC specifications with NV200.

OS & Web browser

- Windows® Internet Explore 8.0 with Windows® 7 Professional 32/64 bits
- * Windows® Internet Explore 8.0 64bits isn't supported
- Windows® Internet Explore 7.0 with Windows® Vista Business SP1 32bits
- Windows® Internet Explore 6.0 SP3 with Windows® XP Professional or Windows® XP Home Edition SP3

CPU

CPU Intel® Core®2 Duo 2.66 GHz or faster

Memory

1GB or more (512MB or more for Windows XP)

Display

1024x768 pixels or more, True color 24 bits or more

Network

10BASE-T, 100BASE-TX or 1000BASE-T, 1port

Other

CD-ROM Drive (to read document),
DirectX 9.0c or later, Sound card

Recommended Network Switch

Current verified network switches (As of Sep. 2010)

■ HP

Camera Qtys	Camera Switch	Layer	Ports		PoE	PoE Power Budget
			Regular	Uplink		
8 port	2520-8- PoE	2	10/100(8)	1000T/SFP(2)	Yes(8)	67W
24 port	2610-24- PWR	2	10/100(24)	1000T/SFP(2)	Yes(24)	370W

■ D-Link

Camera Qtys	Center Switch	Layer	Ports		PoE	PoE Power Budget
			Regular	Uplink		
8 port	DGS-1210-10P	2	Gigabit(8)	1000T/SFP(2)	Yes(8)	78W
24 port	DGS- 1224TP/GE	2	Gigabit(20)	1000T/SFP(4)	Yes(24)	180W
	DGS-3100-24P	2	Gigabit(20)	1000T/SFP(4)	Yes(24)	370W

Example of System diagram (8 port x 1)

- 1Gbps NW Connection
 - between NWSW and WJ-NV200
 - between NWSW and PC
- Only 1 PC is available due to the limit of port number

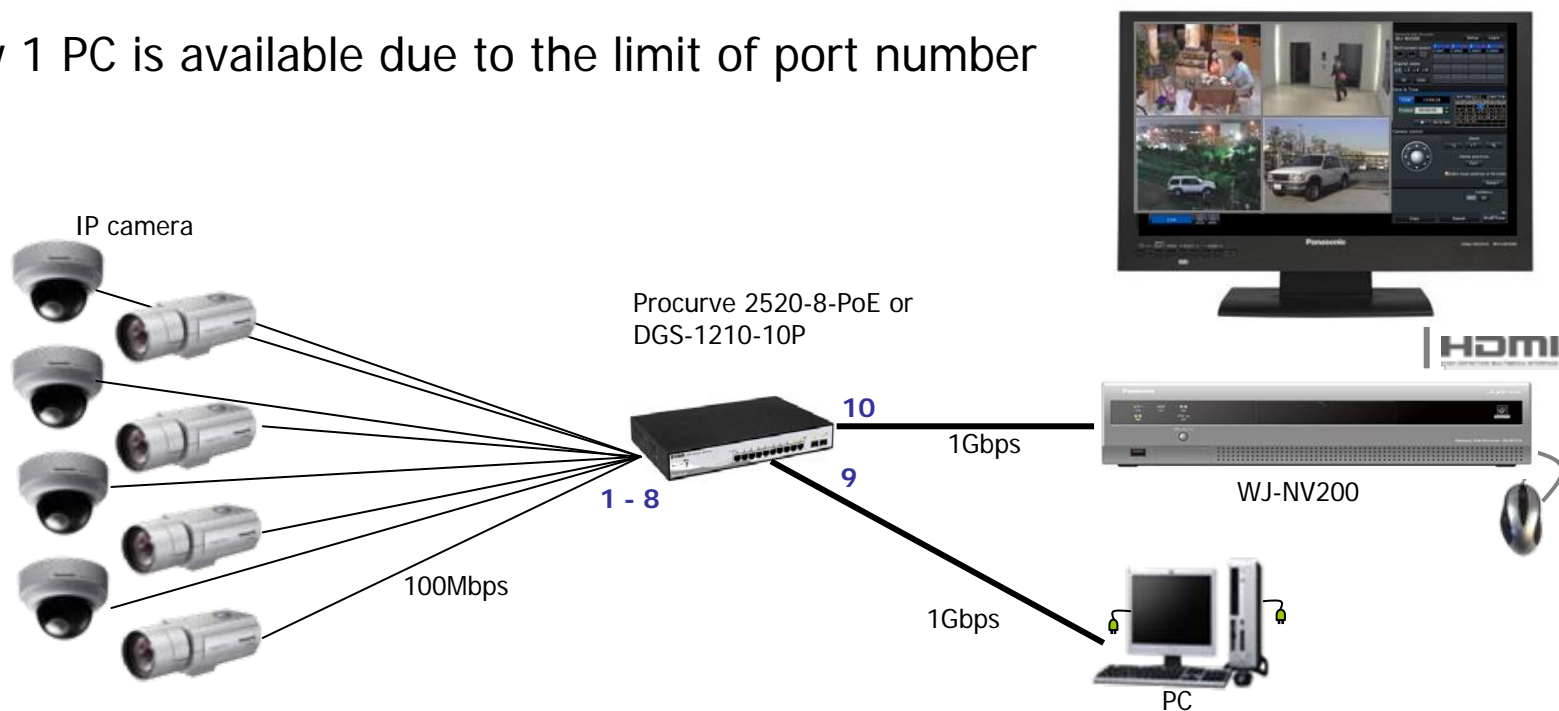

Reference
— : UTP100M
— : UTP1000M

Example of System diagram (8 port x 2)

- 1Gbps NW Connection
 - between NWSW and WJ-NV200
 - between NWSW(1) and NWSW(2)
 - between NWSW and PC
- Only 1 PC is available due to the limit of port number

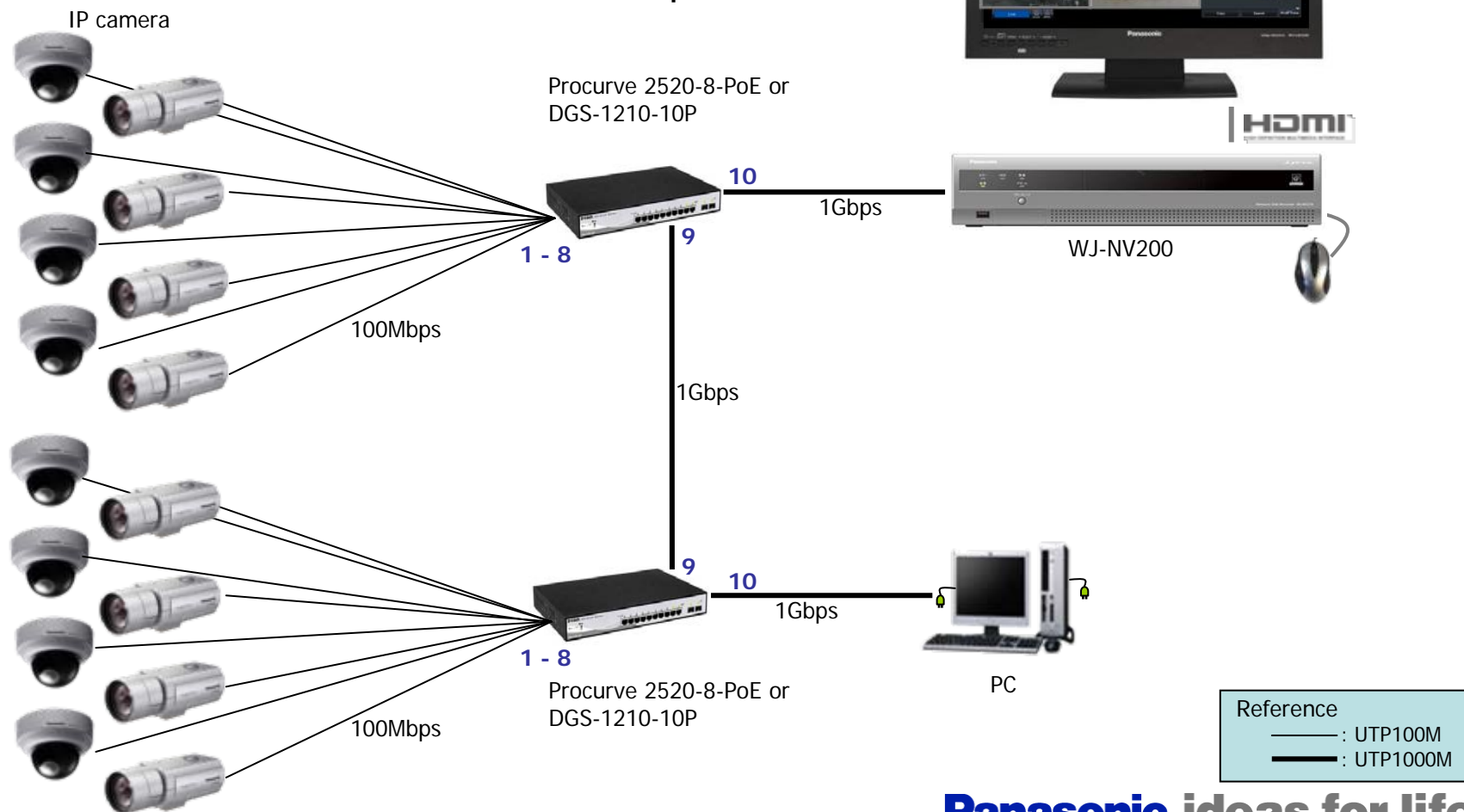

Example of System diagram (24 port x 1) **i-PRO SmartHD**

- 1Gbps NW Connection
 - between NWSW and WJ-NV200
 - between NWSW and PC
- Max 2 PC is available due to the limit of NV200 spec
(*not recommend "Procurve 2610-24- PWR" with 2 PCs)

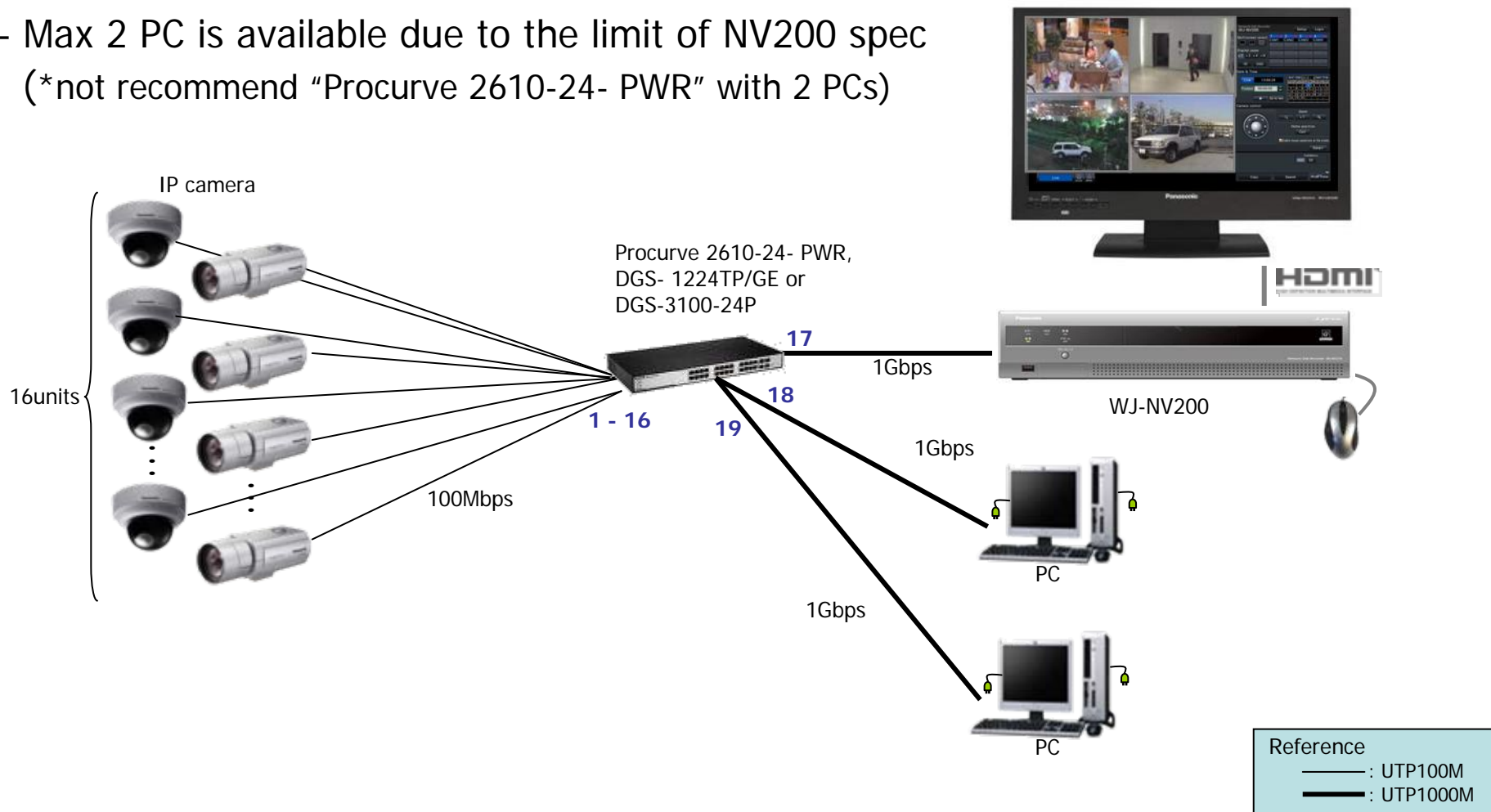

HDD Compatibility

HDD Compatibility Planning



3.5" SATA

Capacity	Vendor	Series	Model	Availability	Compatibility	Status of Verification / Note
1TB	WD	Caviar Green	WD10EARS-**Y5B1	OK	OK	
2TB	WD	Caviar Green	WD20EARS-**MVWB0	OK	OK	
3TB	WD	Caviar Green	WD30EZRS-**XXXXX	(Oct./2010)	-	We are planning to verify its as soon as it will release

NV200K is planned to be supported **WD Caviar Green 3.5" SATA** hard disk drives.

High Capacity ... NV200 has only 2 HDD slots, but sufficient recording capacity for WD Caviar Green.

Low cost ... corresponds with low price of NV200 system.

Low power & heat ... contributes to NV200 simplifying its structure.

Calculation example for recording

Total Disc capacity	Recording days	Recording conditions (Required bitrate for H.264 30fps is 2Mbps at 1280x960 and 1Mbps at 640x480)
2TB (1TB x 2)	10.6 days	16cameras with <u>640x480</u> 30ips, 24hours recording
	5.3days	16cameras with <u>1280x960</u> 30ips, 24hours recording
4TB (2TB x 2)	21.2 days	16cameras with <u>640x480</u> 30ips, 24hours recording
	10.6 days	16cameras with <u>1280x960</u> 30ips, 24hours recording
6TB (3TB x 2)	31.9 days	16cameras with <u>640x480</u> 30ips, 24hours recording
	15.9 days	16cameras with <u>1280x960</u> 30ips, 24hours recording



Specifications 1/2

Title		Specification
General Specifications	Power Source	NTSC : 120V AC, 60Hz
		PAL : 220—240V AC, 50Hz/60Hz
	Power Consumption	Target 65W (T.B.D)
	Ambient Operating Temperature	+5°C~+45°C
	Ambient Operating Humidity	Under 85%
	Dimensions	2U, 420(W) x 88(H) x 300(D)
Front panel	Image/audio output	N/A
	Copy	SD(SDHC) card I/F
	Mouse	USB mouse port
	Restart	Restart SW
	Maintenance port (LAN)	N/A
Rear panel	Video outputs (Live/Playback)	HDMI x 1 (main monitor)
	Video outputs (Live/Spot)	BNC x 1 : 1V[p-p]/75Ω analog composite (Spot output) * Live on 1 sprit screen, Sequence functions
	Audio outputs	-10dBv 600Ω (RCA)
	External port	N/A
	Alarm Source	D-sub 25pin x 1, 9 alarm input, 1 alarm output
	Mode SW	N/A
	Network I/F	10BASE-T/100BASE-TX/1000BASE-T

Specifications 2/2

Title		Specification
Recording	Supported image format	H.264, JPEG, MPEG4 (depending on camera setting)
	Maximum recording rate	30fps with 16ch in H.264 SXVGA stream
	Maximum recording audio number	Same as video input
	Alarm recording	Terminal inputs / Camera alarms / Panasonic Alarm *Support to change recording rate of H.264 recording by alarm input *Not support to change recording resolution and format by alarm input .
	HDD type	3.5 inch Serial ATA HDD, Up to 2 x HDD can be installed *Shipment without HDD
	RAID	N/A
	Hot Swap	N/A
	EXT Storage	N/A
	Copy	SD(SDHC) card
	Alteration Detection	Yes
	Image-encryption	N/A
Pre-recording	Memory recording only (5, 10 or 15 seconds) *Not support HDD recording	
Multi Screen	Live	1/ 4 or 16 sprit screen with menu panel 3/ 6/ 9 or 16 sprit screen with full-screen
	Playback	1or 4 sprit screen
Others	ONVIF	Support camera discovering only (Oct / 2010) Support recording (1Q/2011)