

1. Introduction

This document describes the command interface specification of i-PRO network camera especially for H.265 supported models.

All command interface including all old models are shown on another document.
(New_CGI Command Supported Models for V.x.xx.pdf)

Revise Record

Ver.	Date	Chapter.	Comments
1.00	April 23, 2019	-	Original
1.01	June 12, 2020	2.11.1	Add value "25", "50" for parameter "img_fps"
		5.5.9	Add new CGI command (Switching image quality tuning data)
		6.1	Add capability information for "Zoom ratio for Motorized varifocal lens"
		6.5.4	Add parameter "afmode"
		6.13	Add parameter "pt_operability", "ir_afmode"
		7.5	Add comment
		9.7	Add new CGI command (Add hidden items to setup menu)
		9.8	Add new CGI command (Force PoE injector(60W power supply) mode setup)
		13.1 13.6.13	Add additional information for Scene change detection
1.02	August 20, 2020	12	Add valud "scd_enable", "apend_apl1", "apend_apl2" for parameter "fnc1", "fnc2", "fnc3", "fnc4", "fnc5"
		12	Correction of errors
		7.3.6	Correction of errors
		7.3 13.1	Add comment for WV-XAE200W
		7.11.2	Add message(ASCII) for WV-XAE200W (INTRUDER ALARM, LOITERING ALARM, DIRECTION ALARM, LINE CROSS ALARM)
		13.6.10	Correction of errors
		13.6.15	Add AI-VMD information
1.03	July 28, 2021	5.8	Divide and describe for each type of cameras about "Privacy zone setup"
		6.13	Add the parameter about the maximam number of Privacy zone
		7.10.1	Add the column "HTTP Alarm Protocol" in the table
		7.10.4	Add the parameter "Mothion detect ratio" in the table and in the "Command examples".
		7.10.4.4	Add "[H] i-VMD / AI-VMD alarm", [I] AI-VMD information and [J] Audio detection.
		7.11.2	1. Add the information if "Alarm notification which is generated from Extension Software" or not in the item "Padding" of "Basic message area". 2. Add the alarm notification information of Audio alarm detection, related to WV-XAE203W (No mask alarm detection) and related to WV-XAE207W (AI Occupancy Alarm detection) in "Extension area table contents"
		7.12	Add "HTTP alarm notificaton"
		11.9	Add the parameters related to SMTPv3 in the table (SNMP version, User name, Authentication, Encryption method, Password)
		12	1. Add the parameter to be needed to specify when i-VMD or Bestshot apps is used. 2. The correction of errors: the value of "time_mode1" through "time_mode 5"
		12.2	Add "Schedule setup for extension software"
-	Unify the expression, font type and size. Correct the spelling mistake.		
1.04	December 10, 2021	2.11.1	Add new Image mode
		2.12.1	Add new value for parameter nr framerate
		5.5.3	Add limitation to parameter blc, hlc
		8.2.3	Correct the spelling mistake.

Ver.	Date	Chapter.	Comments
		9.9	New chapter
1.05	April 25, 2022	2.12.4	"resolution_each_mode_all" was added.
		16.1.1.1	New chapter
		16.1.1.2	New chapter
		5.8.1	Parameters for "zone1_display/.....zone8_display" were added.
		11.1.2	New chapter

1.1. Camera model definition

H.265 supported models can be distinguished whether 'h265' is included in the response of "/cgi-bin/get_capability" (Refer to chapter 9.2) or not.

Ex. "video_server.image.format=jpeg, mjpeg, h264, h264_cabac, h265"

PTZ models can be distinguished by

video_server.basic.type=dome

Fixed models can be distinguished by

video_server.basic.type=fixed

or

video_server.basic.type=fixed_dome

Fisheye models can be distinguished by

video_server.basic.fisheye=yes

Multi-sensor models can be distinguished whether the number of sensor is more than two or not.

video_server.image.sensor.number=<numerical value>

Ex. video_server.image.sensor.number=4

1.2. API of basic functions

When the interfaces of only basic functions are required (ex. the first time integration), the following chapter can be used as the example of basic functions.

Function	Chapter
Video Streaming	
H.264 / H.265 transmission(CGI control)	2.2
or	or
H.264 / H.265 transmission(RTSP control)	2.3
H.264/H.265 setup	2.12
Audio Streaming	
Audio input transmission(CGI control)	4.2
or	or
Audio input transmission(RTSP control)	4.3
Audio setup	4.5
Image	
Upside down setup	5.2
Super Dynamic / Wide dynamic range	5.5.2
PTZ	
256 steps pan/tilt and 4 step zoom/focus control	6.2.1
or	or
256 step pan/tilt and 4 step zoom continuous control	6.2.2
Auto focus	6.2.3
Auto back focus (for fixed models)	6.3.3
Automode start and stop	6.4.1
Preset position	6.5
Drag & Zoom	6.11
Click & centering	6.12
Alarm	
I/O	7.1
VMD (Video Motion Detection) setup	7.2
I/O and VMD status notification (New format)	7.10.4
or	or
TCP alarm (Panasonic Alarm Protocol) notification	7.11
SD memory card recording	
Request play back stream	8.2
General	
Get product information	9.1
Get capability	9.2
Get setup data list	9.3
Time & date setup	9.4
or	or
NTP setup	11.8

2. Video Streaming

2.1. Supported Protocol and video codec

H.264 / H.265

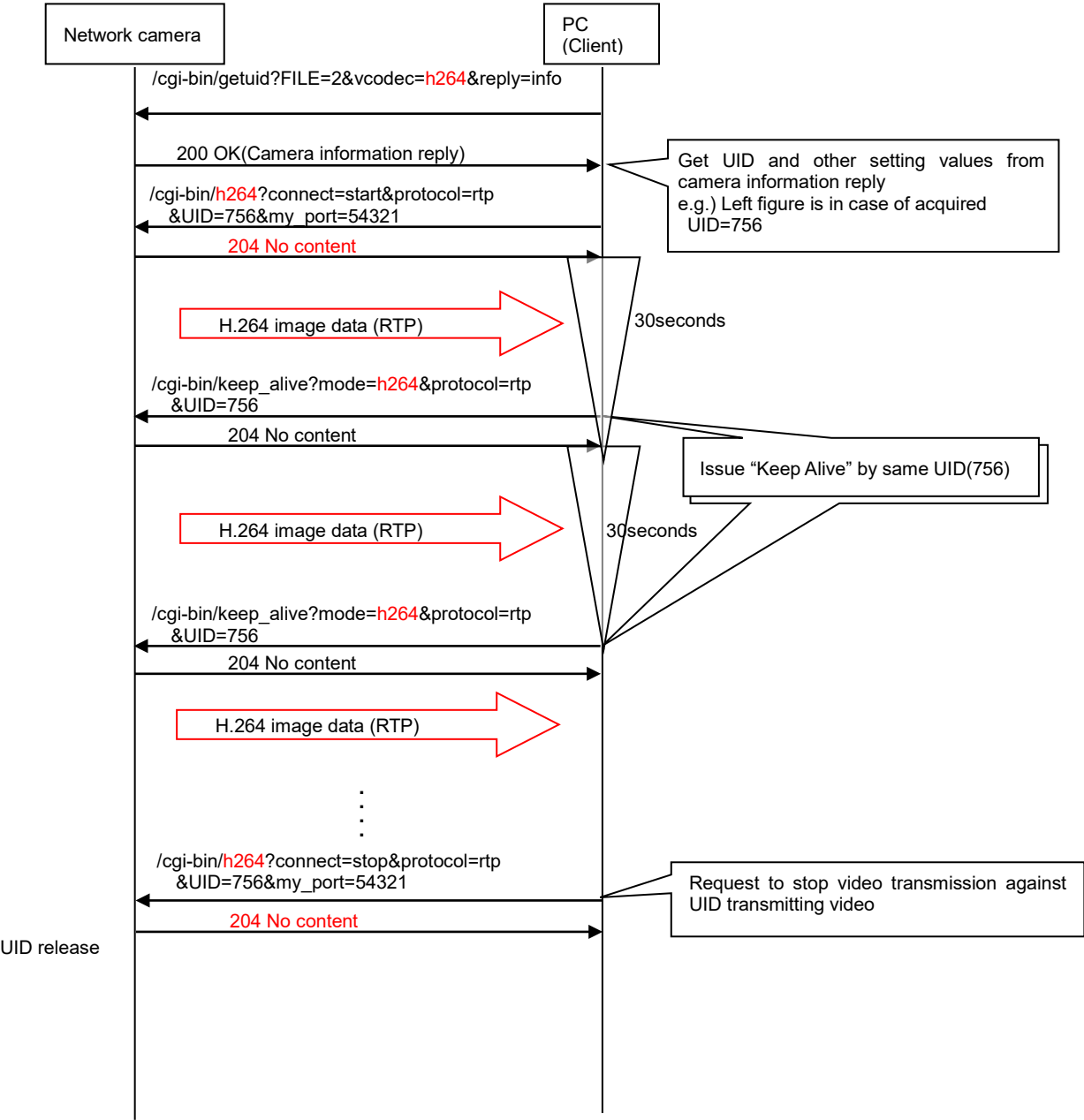
- RTP(CGI control) unicast
- RTP(CGI control) multicast
- RTP(RTSP control) unicast
- RTP(RTSP control) multicast
- RTP over RTSP
- RTP over RTSP over HTTP

JPEG

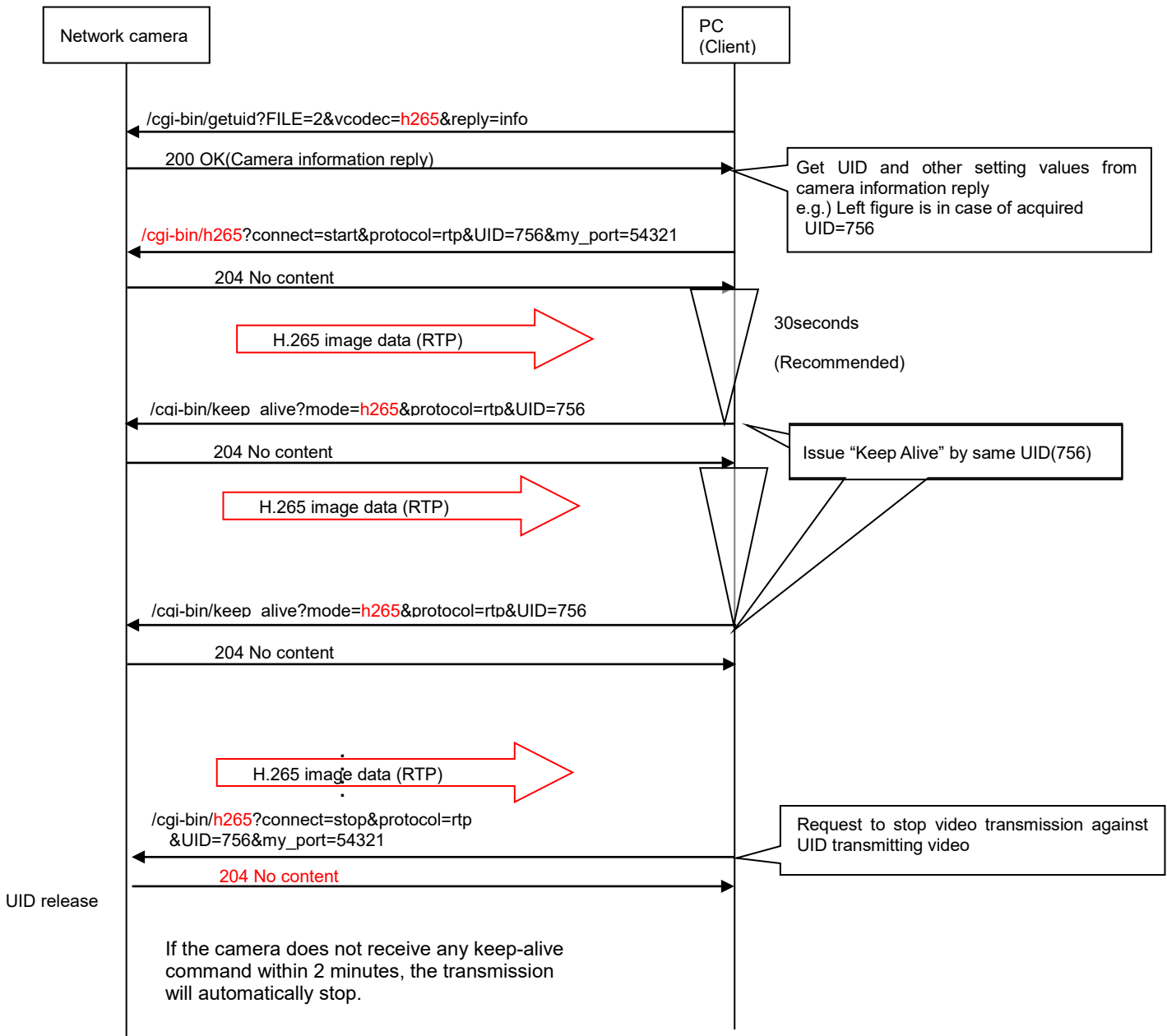
- HTTP snap shot (CGI control)
- HTTP motion JPEG (CGI control)

2.2. H.264 / H.265 transmission (CGI control)

2.2.1. H.264 Sequence



2.2.2. H.265 Sequence



2.2.3. Get UID (User management of video transmission)

[URL] /cgi-bin/getuid?FILE=2&vcodec=< Value>&reply=info[&ch=<Value>]

[Method] GET

[Access level] 3

Parameter name	Value	Comments
FILE	2 (fixed)	2 (fixed)
vcodec	jpeg, jpeg_2 jpeg_3 h264, h264_2 h264_3 h264_4 h265, h265_2 h265_3 h265_4	stream type jpeg : JPEG(1) stream jpeg_2 : JPEG(2) stream jpeg_3 : JPEG(3) stream h264 : H.264 h264_2: H.264 2nd stream h264_3: H.264 3rd stream h264_4: H.264 4th stream h265 : H.265 h265_2: H.265 2nd stream h265_3: H.265 3rd stream h265_4: H.265 4th stream
reply	info(fixed)	info : for PC software (fixed)
ch	1, 2, 3, 4	Channel 1: Channel 1 2: Channel 2 3: Channel 3 4: Channel 4 #This parameter is supported by Multi-sensor models and Quad stream mode of Fisheye models.

[Command example]

Get user ID (In case of H.265 transmission)

<http://192.168.0.10/cgi-bin/getuid?FILE=2&vcodec=h265>

* Model: X8570 (Request to a channel 2)

<http://192.168.0.10/cgi-bin/getuid?FILE=2&vcodec=h265&ch=2>

2.2.4. Response of Get UID

Response data is shown below

```
-----  
UID=< User ID >[CR][LF]  
ImageFormat=< Video format >[CR][LF]  
ImageCaptureMode=< Image Capture Mode >[CR][LF]  
ratio=< Aspect ratio >[CR][LF]  
Rotation=<Rotation>[CR][LF]  
Maxfps=<Maximum frame rate >[CR][LF]  
StreamMode=< Stream mode >[CR][LF]  
iBitrate=< H.265/H.264 bitrate >[CR][LF]  
iResolution=< H.265/H.264 resolution >[CR][LF]  
iQuality=< H.265 / H.264 quality >[CR][LF]  
sDelivery=< Transmissino type setting >[CR][LF]  
iUniPort=< unicast port number >[CR][LF]  
iMultiAdd1=< 1st octet of multicast address >[CR][LF]  
iMultiAdd2=< 2nd octet of multicast address >[CR][LF]  
iMultiAdd3=< 3rd octet of multicast address >[CR][LF]  
iMultiAdd4=< 4th octet of multicast address >[CR][LF]  
iMultiAdd=< multicast address >[CR][LF]  
iMultiPort=< Multicast port number >[CR][LF]  
aEnable=< Audio mode>[CR][LF]  
aEnc=< Audio enc >[CR][LF]  
aBitrate=< Audio bit rate >[CR][LF]  
aBitrate2=< Audio bit rate >[CR][LF]  
aBitrate3=< Audio bit rate >[CR][LF]  
aInterval=< Audio input interval >[CR][LF]  
aInPort=< Audio unicast port number >[CR][LF]  
aOutInterval=< Audio output interval >[CR][LF]  
aOutPort=< Audio output port >[CR][LF]  
aOutStatus=< Audio output status >[CR][LF]  
aOutUID=< Audio output UID >[CR][LF]  
ePort=< Event notification port number >[CR][LF]  
sAlarm=< Alarm status >[CR][LF]  
SDrec=< Recording status >[CR][LF]  
SDrec2=< Recording status >[CR][LF]  
sAUX=< Aux status >[CR][LF]  
iHttpPort=< HTTP port number >[CR][LF]  
iMultiAuto_h264_1=< Multicast auto for Stream (1) >[CR][LF]  
iMultiAuto_h264_2=< Multicast auto Stream (2) >[CR][LF]  
iMultiAuto_h264_3=< Multicast auto Stream (3) >[CR][LF]  
iMultiAuto_h264_4=< Multicast auto Stream (4) >[CR][LF]  
sRtspMode_h264_1=< Control mode Stream (1) >[CR][LF]  
sRtspMode_h264_2=< Control mode Stream (2) >[CR][LF]  
sRtspMode_h264_3=< Control mode Stream (3) >[CR][LF]  
sRtspMode_h264_4=< Control mode Stream (4) >[CR][LF]  
StreamEncode=< Encode setting for Stream(1) >[CR][LF]  
StreamEncode_2=< Encode setting for Stream(2) >[CR][LF]  
StreamEncode_3=< Encode setting for Stream(3) >[CR][LF]  
StreamEncode_4=< Encode setting for Stream(4) >[CR][LF]  
iTransmit_mode_1=< trans mission priority setting for Stream(1) >[CR][LF]  
iTransmit_mode_2=< trans mission priority setting for Stream(1) >[CR][LF]  
iTransmit_mode_3=< trans mission priority setting for Stream(1) >[CR][LF]  
iTransmit_mode_4=< trans mission priority setting for Stream(1) >[CR][LF]  
iSmartCoding=< Smart coding setting for Stream(1) >[CR][LF]  
iSmartCoding_2=< Smart coding setting for Stream(2) >[CR][LF]  
iSmartCoding_3=< Smart coding setting for Stream(3) >[CR][LF]  
iSmartCoding_4=< Smart coding setting for Stream(4) >[CR][LF]  
-----
```

Comments

Parameter name	Response value	Comments
UID	Numerical value	User ID [response] 1~65532 : UID 0,65533,65534,65535: UID for multicast stream [Error response] -1: the number of user has been already full. -2: Image format requested is different from the setting. -3: stream number requested is not available -4: channel number requested is not available
ImageFormat	jpeg, h264, h264_2, h264_3, h264_4 h265, h265_2, h265_3, h265_4	Video format which can be transmitted with this UID obtained from a camera. jpeg : JPEG h264 : H.264 h264_2 : H.264 2nd stream h264_3 : H.264 3rd stream h264_4 : H.264 4th stream h265 : H.265 h265_2 : H.265 2nd stream h265_3 : H.265 3rd stream h265_4 : H.265 4th stream
ImageCaptureMode	1.3m,2m,3m 5m,8m_15,8m_30 9m	Current value of the Image capture mode setting 1.3m: 1.3Mega pixel mode 2m: 2Mega pixel mode 3m :3Mega pixel mode 5m: 5Mega pixel mode 8m_15: 8Mega pixel 15 fps mode 8m_30: 8Mega pixel 30 fps mode 9m: 9Mega pixel mode
ratio	4_3, 16_9, 1_1	Aspect ratio 4_3: 4:3 mode 16_9: 16:9 mode 1_1: 1:1 mode
Rotation	0, 90, 180, 270	Image rotation: 0: 0degree, 90: 90 degree 180: Upside down 270: 270 degree
Maxfps	15, 30, 60	Maximum framerate 15: 15fps, 30: 30fps 60: 60fps
StreamMode	1 (fixed)	1(fixed)

Parameter name	Response value	Comments
iBitrate	64, 128, 256, 384, 512, 768, 1024, 1536, 2048, 3072, 4096, 6144, 8192, 10240, 12288, 14336, 16384, 20480, 24576,	Current value of the H.264/H.265 bandwidth setting. 64 : 64kbps, 128 : 128 kbps, 256 : 256 kbps, 384: 384 kbps, 512: 512 kbps, 768: 768 kbps, 1024: 1024 kbps, 1536: 1536 kbps, 2048: 2048 kbps, 3072: 3072 kbps, 4096: 4096 kbps, 6144: 6144 kbps 8192: 8192 kbps, 10240: 10240 kbps, 12288: 12288 kbps 14336: 14336 kbps 16384: 16384 kbps 20480: 20480 kbps 24576: 24576 kbps
iResolution	3840 3072 2992 2560 2192, 2048 1920 1600 1280 800 640 400 320	Current value of the H.265 / H.264 resolution setting Resolution to be set (4:3) 320 : QVGA 400 : 400x300 640 : VGA 1280 : 1280 x 960 2048 : 2048 x 1536 800 800 x 600 1600: 1600x1200 2560: 2560x1920 3072: 3072x2304 Resolution to be set (16:9) 640 : 640 x 360 320 : 320 x 180 1280 : 1280 x 720 1920 : 1920 x 1080 2560: 2560x1440 3072: 3072x1728 3840: 3840x2160 Resolution to set (1:1) 640 : 640 x 640 320 : 320 x 320 1280 : 1280 x 1280 2192 : 2192 x 2192 2992 : 2992 x 2992
iQuality	fine, normal, low 0, 1, 2, 3, 4, 5,6, 7, 8, 9	Current value of the H.265/ H.264 quality setting fine : Fine normal: Normal low : Low 0, 1, 2, 3, 4, 5, 6, 7, 8, 9 : 10 step setting when VBR
sDelivery	uni, multi, uni_manual	Current value for Transmission type 'uni' or 'uni_manual' : Unicast is available multi : Multicast is available

Parameter name	Response value	Comments
iMultiAdd1	224 to 239	Current value of 1 st octet of multicast address setting
iMultiAdd2	0 to 255	Current value of 2 nd octet of multicast address setting
iMultiAdd3	0 to 255	Current value of 3 rd octet of multicast address setting
iMultiAdd4	0 to 255	Current value of 4 th octet of multicast address setting
iMultiAdd	(IP address)	Current value of multicast address setting
iMultiPort	numerical value	Current value of multicast port number setting.
aEnable	off, in, out, inout, inout_full	Current value of audio mode setting off : OFF in : audio input out : audio output inout : interactive inout_full: Interactive (full duplex) [Note] # This information is used for audio transmission
aEnc	0, 1, 2	Audio encoder setup 0: G.726 1: G.711 2: AAC-LC
aBitrate	32, 16	Current value of audio bit rate setting(G.726) 32 : 32kbps, 16 : 16kbps
aBitrate2	64	Current value of audio bit rate setting(G.711) 64: 64kbps
aBitrate3	64	Current value of audio bit rate setting(AAC-LC) 64: 64kbps, 96: 96kbps, 128: 128kbps
aInterval	20, 40, 80, 160	Current value of audio input interval setting (from camera to PC) 20 : 20 msec 40 : 40 msec 80 : 80 msec 160 : 160 msec [Note] # This information is used for audio transmission
aOutInterval	160, 320, 640, 1280	Current value of audio output interval setting (from PC to camera) 160 : 160msec 320 : 320msec 640 : 640msec 1280 : 1280msec [Note] # This information is used for audio transmission
aOutPort	1024 to 50000	Current value of audio output port setting (from PC to camera) [Note] # This information is used for audio transmission
aOutStatus	on, off	Status of audio output function on : busy off : not busy [Note] # This information is used for audio transmission

Parameter name	Response value	Comments
aOutUID	numerical value	UID that is transmitting "audio output" [Note] # This information is used for audio transmission
sAlarm	ON, OFF	Alarm status (CH1) ON: Alarm occurred OFF: Alarm does not occurred
SDrec	on, off, disable	Status of SD card recording stream 1 on: Now recording off: Now not recording disable: cannot use SD recording
SDrec2	on, off, disable	Status of SD card recording stream 2
sAUX	open, close, off	AUX status open: OPEN close: CLOSE off: AUX is disabled
iHttpPort	numerical value	Current value of HTTP port number setting.
iMultiAuto_h264	0, 1	Multicast auto start(Stream(1)(H.264/H.265)) 0: OFF ,1: ON
iMultiAuto_h264_2	0, 1	Multicast auto start Stream(2)(H.264/H.265))
iMultiAuto_h264_3	0, 1	Multicast auto start Stream(3)(H.264/H.265))
iMultiAuto_h264_4	0, 1	Multicast auto start Stream(4)(H.264/H.265))
StreamEncode	1, 2	Encode setting of stream(1) 1:H.264, 2:H.265
StreamEncode_2	1, 2	Encode setting of stream(2)
StreamEncode_3	1, 2	Encode setting of stream(3)
StreamEncode_4	1, 2	Encode setting of stream(4)
iTransmit_mode	0, 1, 2, 4	Stream(1) priority setting 0: Bit rate priority 1: Frame rate priority 2: Best effort mode 4: VBR
iTransmit_mode_2	0, 1, 2, 3, 4	Stream(2) priority setting
iTransmit_mode_3	0, 1, 2, 3, 4	Stream(3) priority setting
iTransmit_mode_4	0, 1, 2, 3, 4	Stream(4) priority setting
iSmartCoding	0, 1, 2, 4, 5	Stream(1) Smartcoding setting 0: Off, 1: On(Low), 2: On(Mid), 4: On(Advanced),5: On(Frame rate control)
iSmartCoding_2	0, 1, 2, 4, 5	Stream(2) Smartcoding setting
iSmartCoding_3	0, 1, 2, 4, 5	Stream(3) Smartcoding setting
iSmartCoding_4	0, 1, 2, 4, 5	Stream(4) Smartcoding setting
The following parameters can be used for Multi-sensor models		
sAlarm2	ON, OFF	Alarm status (CH2)
sAlarm3	ON, OFF	Alarm status (CH3)
sAlarm4	ON, OFF	Alarm status (CH4)
iTransmit_mode_cam2	0, 1, 2, 3, 4	Stream(1) ch2 priority setting
iTransmit_mode_2_cam2	0, 1, 2, 3, 4	Stream(2) ch2 priority setting
iTransmit_mode_cam3	0, 1, 2, 3, 4	Stream(1) ch3 priority setting
iTransmit_mode_2_cam3	0, 1, 2, 3, 4	Stream(2) ch3 priority setting
iTransmit_mode_cam4	0, 1, 2, 3, 4	Stream(1) ch4 priority setting
iTransmit_mode_2_cam4	0, 1, 2, 3, 4	Stream(2) ch4 priority setting
iSmartCoding_cam2	0, 1, 2, 4, 5	Stream(1) ch2 Smartcoding setting
iSmartCoding_2_cam2	0, 1, 2, 4, 5	Stream(2) ch2 Smartcoding setting
iSmartCoding_cam3	0, 1, 2, 4, 5	Stream(1) ch3 Smartcoding setting
iSmartCoding_2_cam3	0, 1, 2, 4, 5	Stream(2) ch3 Smartcoding setting
iSmartCoding_cam4	0, 1, 2, 4, 5	Stream(1) ch4 Smartcoding setting
iSmartCoding_2_cam4	0, 1, 2, 4, 5	Stream(2) ch4 Smartcoding setting

Parameter name	Response value	Comments
The following parameters can be used for Fisheye models		
Fisheye_ImageMode	wpanorama QuadPTZ SinglePTZ panorama 4stream 9m_fisheye 5m_fisheye 9m_fisheye_wpanorama 5m_fisheye_wpanorama 9m_fisheye_panorama 5m_fisheye_panorama 9m_fisheye_QuadPTZ 5m_fisheye_QuadPTZ	Image capture mode of the Fish eye camera wpanorama: Double Panorama mode QuadPTZ: Quad PTZ mode SinglePTZ: Single PTZ mode panorama: Panorama mode 4stream: Quad streams mode 9m_fisheye: 9M fisheye mode 5m_fisheye: 5M fisheye mode 9m_fisheye_wpanorama: 9MFisheye+Double panorama 5m_fisheye_wpanorama: 5MFisheye+Double panorama 9m_fisheye_panorama: 9MFisheye+Panorama 5m_fisheye_panorama: 5MFisheye+Panorama 9m_fisheye_QuadPTZ: 9MFisheye+QuadPTZ 5m_fisheye_QuadPTZ: 5MFisheye+QuadPTZ
Fisheye_UpsideDown	ceiling wall	Ceiling or wall setting of the Fish eye camera ceiling: Ceiling wall: Wall
Fisheye_PTZ	yes no	PTZ enable or not enable of the Fish eye camera yes: Enable no: Disable

2.2.5. H.264 start/stop transmission

[URL]

/cgi-bin/h264?connect=<Value>[&my_port=<Value>]&UID=<Value>[&stream=<Value>][&ch=<Value>]

[Method] GET

[Access level] 3

Parameter name	Value	Comments
connect	start, stop	Transmit video stream transmission start : start video stream transmission stop : stop video stream transmission (for user ID which has already started stream transmission) *The value 'stop' is effective only unicast setting.
my_port	numerical value	Receive port no. of H.264 * This parameter can't be omitted in case unicast setting.
protocol	rtp	rtp (fixed) * This parameter can be omitted.
UID	numerical value	User ID(acquired UID) * This parameter can't be omitted.
stream	1, 2 3, 4	Specify the H.264 stream. 1 :Stream 1 2 :Stream 2 3 :Stream 3 4 :Stream 4 Default: 1 #This parameter can be omitted.
ch	1, 2, 3, 4	Channel 1: Channel 1 2: Channel 2 3: Channel 3 4: Channel 4 #This parameter is supported by Multi-sensor models and "Quad stream" mode for fisheye models. When this parameter is omitted, it works as a channel 1.

[Command example]

Start to transmit H.264 video stream (in case that port no. 40000 and user ID is 263)

http://192.168.0.10/cgi-bin/h264?my_port=40000&connect=start&protocol=rtp&UID=263

* Model: X8570 (Request to a channel 2)

http://192.168.0.10/cgi-bin/h264?my_port=40000&connect=start&protocol=rtp&UID=263&ch=2

2.2.6. H.265 start/stop transmission

[URL]

/cgi-bin/h265?connect=<Value>[&my_port=<Value>]&UID=<Value>[&stream=<Value>][&ch=<Value>]

[Method] GET

[Access level] 3

Parameter name	Value	Comments
connect	start stop	Transmit video stream transmission (H.265) start : start video stream transmission stop : stop video stream transmission (for user ID which has already started stream transmission) *The value 'stop' is effective only unicast setting.
my_port	numerical value	Receive port no. of H.265 * This parameter can't be omitted in case unicast setting.
protocol	rtp	rtp (fixed) * This parameter can be omitted.
UID	numerical value	User ID(acquired UID) * This parameter can't be omitted.
stream	1, 2 3, 4	Specify the stream number 1 :Stream 1 2 :Stream 2 3 :Stream 3 4 :Stream 4 #This parameter can be omitted. (Default: 1)
ch	1, 2, 3, 4	Channel 1: Channel 1 2: Channel 2 3: Channel 3 4: Channel 4 #This parameter is supported by Multi-sensor models and "Quad stream" mode for fisheye camera. When this parameter is omitted, it works as a channel 1.

[Command example]

Start to transmit H.265 video stream (in case that port no. 40000 and user ID is 263)

http://192.168.0.10/cgi-bin/h265?my_port=40000&connect=start&protocol=rtp&UID=263

2.2.7. Keep Alive

[URL]

[/cgi-bin/keep-alive?mode=<Value>&prococol=<Value>&UID=<Value>\[&ch=<Value>\]](#)

[Method] GET

[Access level] 3

Parameter name	Value	Comments
mode	jpeg, jpeg_2, jpeg_3 audio, h264, h264_2, h264_3, h264_4, h265, h265_2, h265_3, h265_4	jpeg : "Keep Alive" of JPEG(1) jpeg_2 : "Keep Alive" of JPEG(2) stream jpeg_3 : "Keep Alive" of JPEG(3) stream audio : "Keep Alive" of audio h264 : "Keep Alive" of H.264 h264_2: "Keep Alive" of H.264(2) h264_3: "Keep Alive" of H.264(3) h264_4: "Keep Alive" of H.264(4) h265 : H.265 h265_2: H.265 2nd stream h265_3: H.265 3rd stream h265_4: H.265 4th stream
protocol	rtp http	Transmission method rtp : RTP transmission (H.265, H.264, audio) http : HTTP transmission (JPEG, audio)
UID	0 to 65535	User ID(acquired UID)
ch	1, 2, 3, 4	Channel 1: Channel 1 2: Channel 2 3: Channel 3 4: Channel 4 #This parameter is supported by Multi-sensor models and "Quad stream" mode for fisheye camera. When this parameter is omitted, it works as a channel 1.

[Command example]

H.264 keep-alive command (stream 2)

http://192.168.0.10/cgi-bin/keep_alive?mode=h264_2&protocol=rtp&UID=263&stream=2

Audio keep-alive command (stream 2)

http://192.168.0.10/cgi-bin/keep_alive?mode=audio&protocol=rtp&UID=263&stream=2

*Model: X8570 of the H.264 keep-alive command (stream 2) (Request to a channel 2)

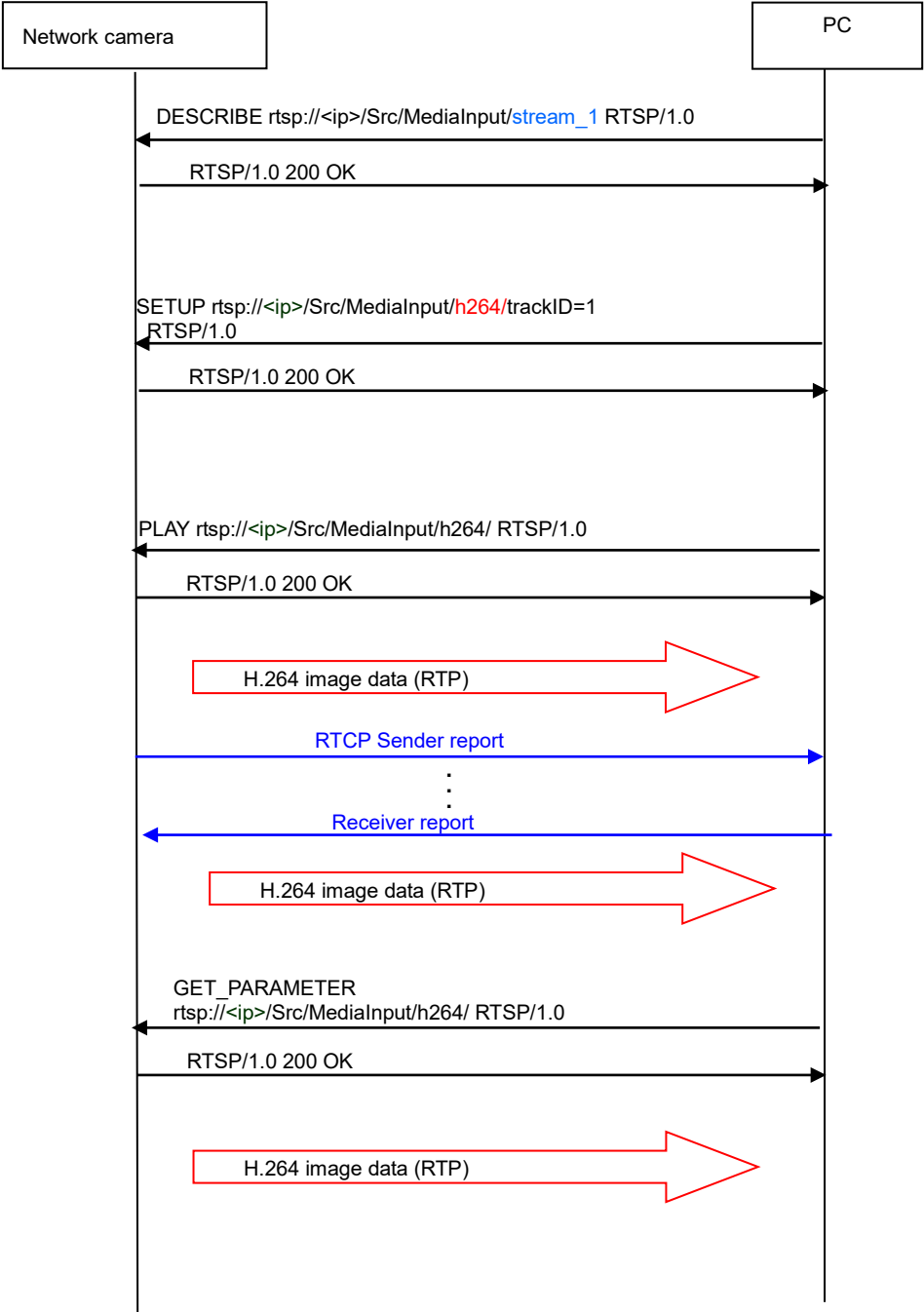
http://192.168.0.10/cgi-bin/keep_alive?mode=h264&protocol=rtp&UID=263&stream=2&ch=2

2.3. H.264 / H.265 transmission (RTSP control)

2.3.1. H.264 Sequence

The sequence of H.264 RTP transmission controlled by RTSP is described as follows.

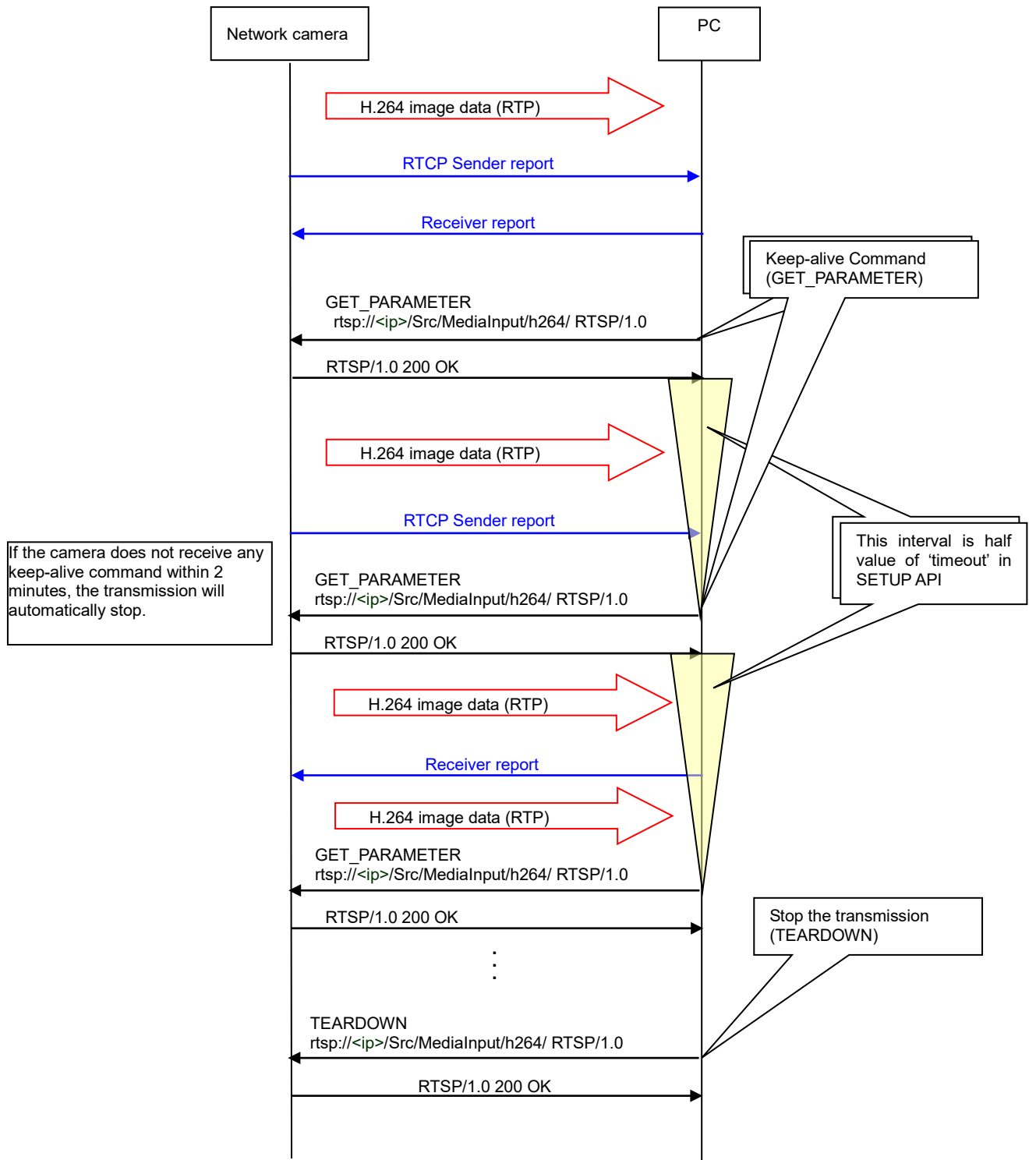
(1) Start the transmission



(2) Keep-alive and stop the transmission

Camera receives following command as keep-alive

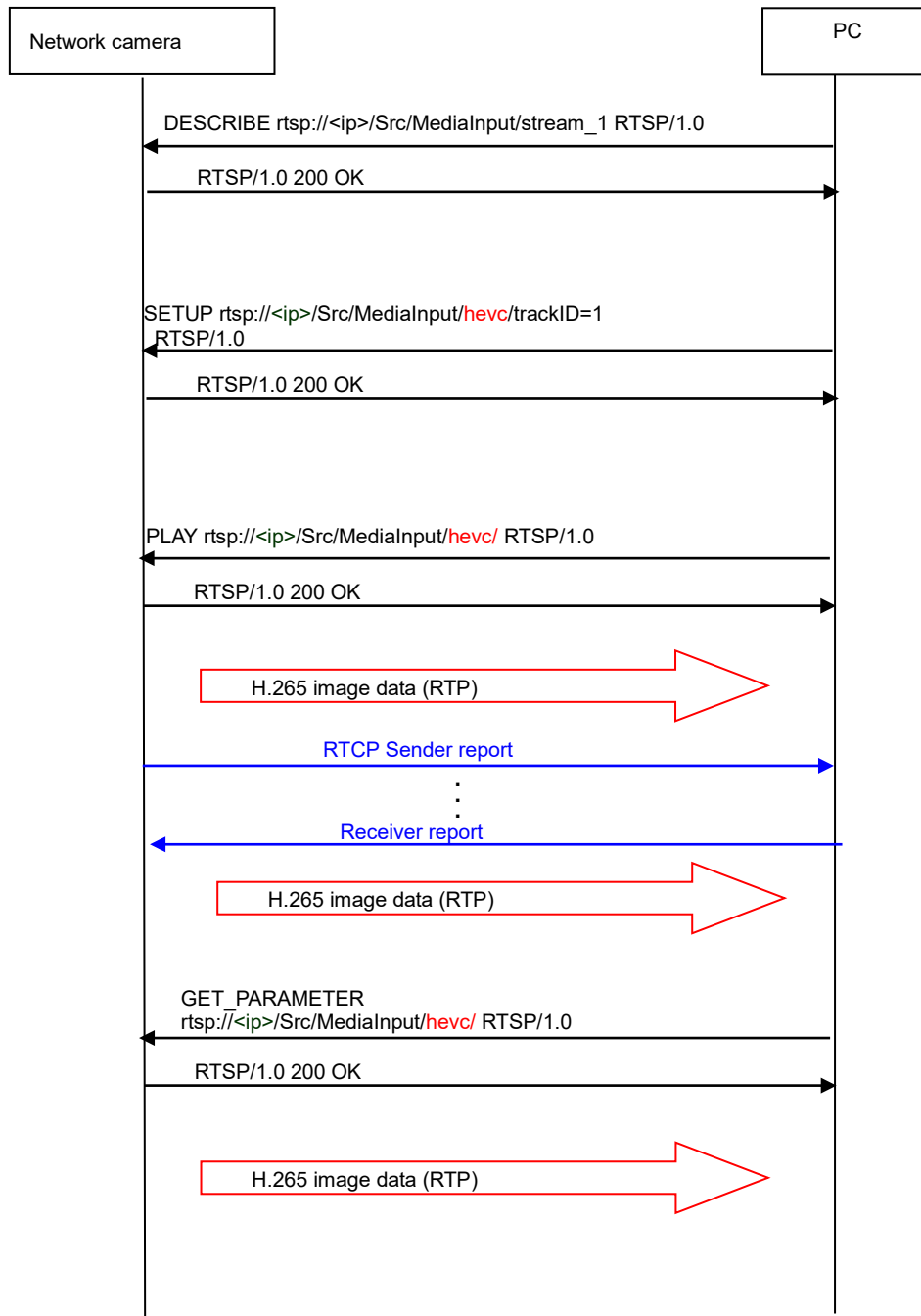
OPTIONS,GET_PARAMETER(recommend),SET_PARAMETER,RTCP Receiver report



2.3.2. H.265 Sequence

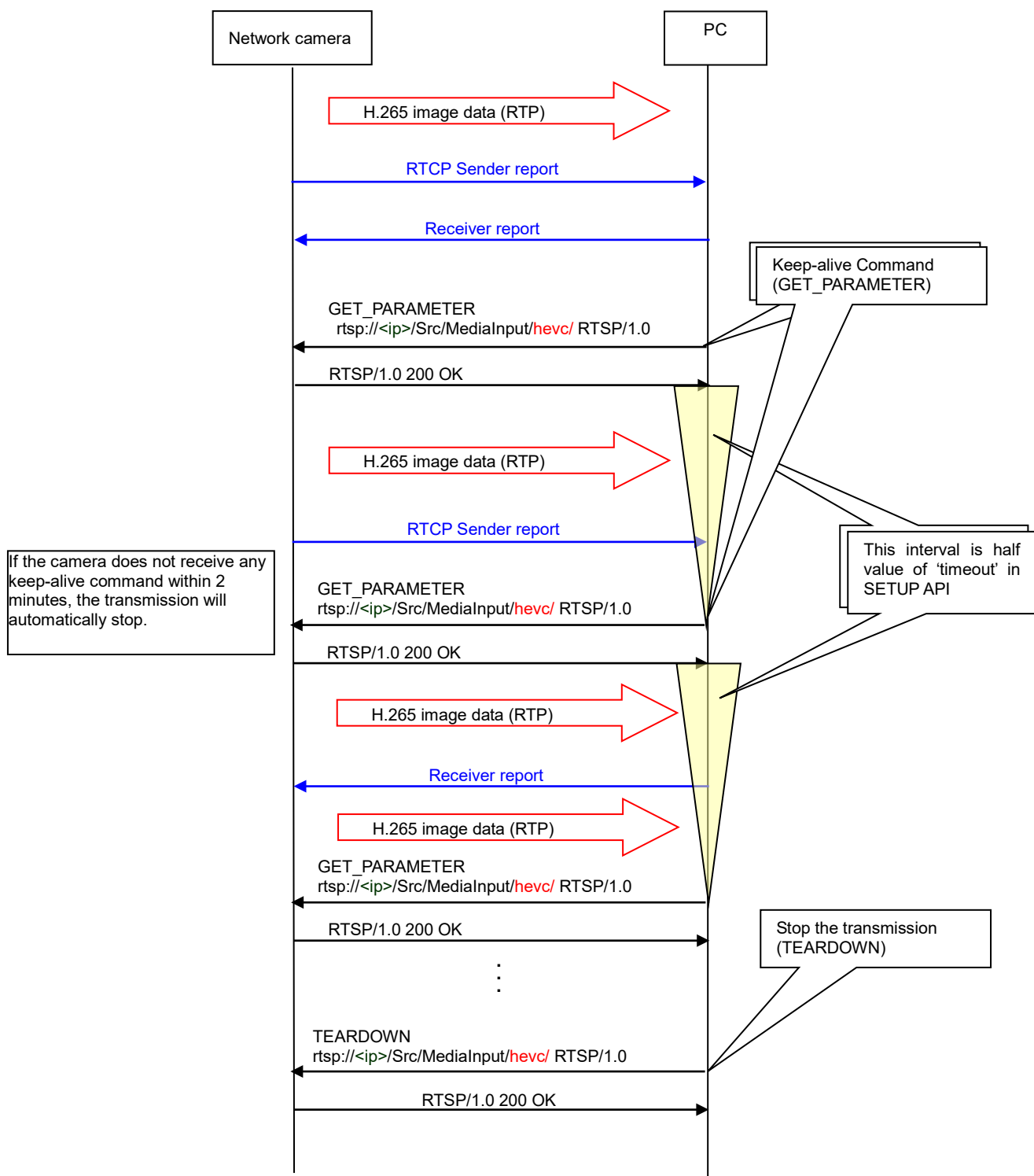
The sequence of H.265 RTP transmission controlled by RTSP is described as follows.

(1) Start the transmission



(2) Keep-alive and stop the transmission

Camera receives following command as keep-alive
 OPTIONS, GET_PARAMETER(recommend), SET_PARAMETER, RTCP Receiver report



2.3.3. RTSP URL

URL	comment
rtsp://<ip address>/Src/MediaInput/stream_1	stream(1) H.265/H.264
rtsp://<ip address>/Src/MediaInput/stream_2	stream(2) H.265/H.264
rtsp://<ip address>/Src/MediaInput/stream_3	stream(3) H.265/H.264
rtsp://<ip address>/Src/MediaInput/stream_4	stream(4) H.265/H.264
For Multi-sensor models and Quad stream mode for Fisheye camera	
rtsp://<ip address>/Src/MediaInput/stream_1/ch_1	stream(1) ch1 H.265/H.264
rtsp://<ip address>/Src/MediaInput/stream_1/ch_2	stream(1) ch2 H.265/H.264
rtsp://<ip address>/Src/MediaInput/stream_1/ch_3	stream(1) ch3 H.265/H.264
rtsp://<ip address>/Src/MediaInput/stream_1/ch_4	stream(1) ch4 H.265/H.264
rtsp://<ip address>/Src/MediaInput/stream_2/ch_1	stream(2) ch1 H.265/H.264
rtsp://<ip address>/Src/MediaInput/stream_2/ch_2	stream(2) ch2 H.265/H.264
rtsp://<ip address>/Src/MediaInput/stream_2/ch_3	stream(2) ch3 H.265/H.264
rtsp://<ip address>/Src/MediaInput/stream_2/ch_4	stream(2) ch4 H.265/H.264
The following URL are legacy URL. These can use only when the encode type is set to H.264. If the setting doesn't set H.264, the camera reply error 503.	
rtsp://<ip address>/Src/MediaInput/h264	stream(1) H.264
rtsp://<ip address>/Src/MediaInput/h264/stream_1	stream(1) H.264
rtsp://<ip address>/Src/MediaInput/h264/stream_1/ch_1	stream(1) ch1 H.264
rtsp://<ip address>/Src/MediaInput/h264/stream_1/ch_2	stream(1) ch2 H.264
rtsp://<ip address>/Src/MediaInput/h264/stream_1/ch_3	stream(1) ch3 H.264
rtsp://<ip address>/Src/MediaInput/h264/stream_1/ch_4	stream(1) ch4 H.264
rtsp://<ip address>/Src/MediaInput/h264/stream_2	stream(2) H.264
rtsp://<ip address>/Src/MediaInput/h264/stream_2/ch_1	stream(2) ch1 H.264
rtsp://<ip address>/Src/MediaInput/h264/stream_2/ch_2	stream(2) ch2 H.264
rtsp://<ip address>/Src/MediaInput/h264/stream_2/ch_3	stream(2) ch3 H.264
rtsp://<ip address>/Src/MediaInput/h264/stream_2/ch_4	stream(2) ch4 H.264
rtsp://<ip address>/Src/MediaInput/h264/stream_3	stream(3) H.264
rtsp://<ip address>/Src/MediaInput/h264/stream_4	stream(4) H.264

2.3.4. Command description

2.3.4.1. DESCRIBE

(1) Request example

```
DESCRIBE rtsp://<ip address>/Src/MediaInput/stream_1 RTSP/1.0
CSeq: 1
Accept: application/sdp
User-Agent: <client>
```

(2) Response example

```
RTSP/1.0 200 OK
CSeq: 1
Connection: Keep-Alive
Content-Base: rtsp://<ip address>/Src/MediaInput/h264/
Content-type: application/sdp
Content-length: 420
```

[sdp sample]

```
v=0
o=- 1 1 IN IP4 192.168.0.10
s=Media Presentation
e=NONE
c=IN IP4 0.0.0.0
b=AS:3024
t=0 0
a=control:*
a=range:npt=now-
m=video 0 RTP/AVP 98
b=AS:8000
a=framrate:30.0
a=control:trackID=1
a=rtptime:98 H264/90000
a=fmtp:98 packetization-mode=1; profile-level-id=640028; sprop-parameter-sets=Z2QAKK3FTYQ4jJNipsI
cRkxmU2EOlyTRBijEc2SSIJEYjmySRBijEc2SQtAUB7/gNUgAAF3YAAr8h7ED6AAC0Dd///9iB9AABaBu
///1,aM44MA==
a=h264-esid:201
c=IN IP4 239.192.0.20/16 (* when multicast is set, this line exists)
m=audio 0 RTP/AVP 97 (* when audio(G.726) is enable, following lines exist)
b=AS:16
a=control:trackID=2
a=rtptime:97 G726-16/8000
a=h264-esid:201
c=IN IP4 239.192.0.20/16 (* when multicast is set, this line exists)
```

2.3.4.2. SETUP

(1) Request video example

```
SETUP rtsp://<ip address>/Src/MediaInput/h264/trackID=1 RTSP/1.0
CSeq: 2
Transport: RTP/AVP;unicast;client_port=6970-6971 (*)
User-Agent: <client>
```

*When multicast

```
Transport: RTP/AVP;multicast;client_port=49830-49831
```

(2) Response example

```
RTSP/1.0 200 OK
CSeq: 2
Connection: Keep-Alive
Session: 343003461131330550741819087776;timeout=120
Transport: RTP/AVP/UDP;unicast;client_port=6970-6971;server_port=59008-59009;ssrc=6ac0df3d (*)
```

*When multicast

```
Transport: RTP/AVP/UDP;multicast;destination=239.192.0.20;tll=16;port=37004-37005;ssrc=f8ecf253
```

(3) Request audio example

```
SETUP rtsp://<ip address>/Src/MediaInput/h264/trackID=2 RTSP/1.0
CSeq: 3
Transport: RTP/AVP;unicast;client_port=6972-6973 (*)
User-Agent: <client>
```

*When multicast

```
Transport: RTP/AVP;multicast;client_port=49832-49833
```

(4) Response example

```
RTSP/1.0 200 OK
CSeq: 3
Connection: Keep-Alive
Session: 343003461131330550741819087776;timeout=120
Transport: RTP/AVP/UDP;unicast;client_port=6972-6973;server_port=59010-59011;ssrc=6ac0df3d (*)
```

*When multicast

```
Transport: RTP/AVP/UDP;multicast;destination=239.192.0.20;tll=16;port=38004-38005;ssrc=5a11fe48
```

2.3.4.3. PLAY

(1) Request example

```
Request: PLAY rtsp://<ip address>/Src /MediaInput/h264/ RTSP/1.0
CSeq: 3
Range: npt=0.000000-
Session: 343003461131330550741819087776
User-Agent: <client>
```

(2) Response example

```
RTSP/1.0 200 OK
CSeq: 3
Connection: Keep-Alive
Session: 343003461131330550741819087776
RTP-Info: url=rtsp://192.168.0.10/Src /MediaInput/h264/trackID=1;
seq=1634890799;rtptime=1145662307
```

2.3.4.4. TEARDOWN

(1) Request example

```
TEARDOWN rtsp://<ip address>/Src /MediaInput/h264/ RTSP/1.0
```

CSeq: 4
Session: 343003461131330550741819087776
User-Agent: <client>

(2) Response example

RTSP/1.0 200 OK
CSeq: 4
Connection: Keep-Alive
Session: 343003461131330550741819087776

2.3.4.5. OPTIONS

(1) Request example

OPTIONS rtsp://<ip address>/Src /MediaInput/h264/ RTSP/1.0
CSeq: 18
User-Agent: <client>

(2) Response example

RTSP/1.0 200 OK
CSeq: 18
Connection: Keep-Alive
Public: DESCRIBE, GET_PARAMETER, OPTIONS, PAUSE, PLAY, SETUP, TEARDOWN

2.3.4.6. PAUSE

(1) Request example

PAUSE rtsp://<ip address>/Src /MediaInput/h264/ RTSP/1.0
CSeq: 6
Session: 343003461131330550741819087776
User-Agent: <client>

(2) Response example

RTSP/1.0 200 OK
CSeq: 6
Connection: Keep-Alive
Session: 343003461131330550741819087776

2.3.4.7. GET_PARAMETER

(1) Request example

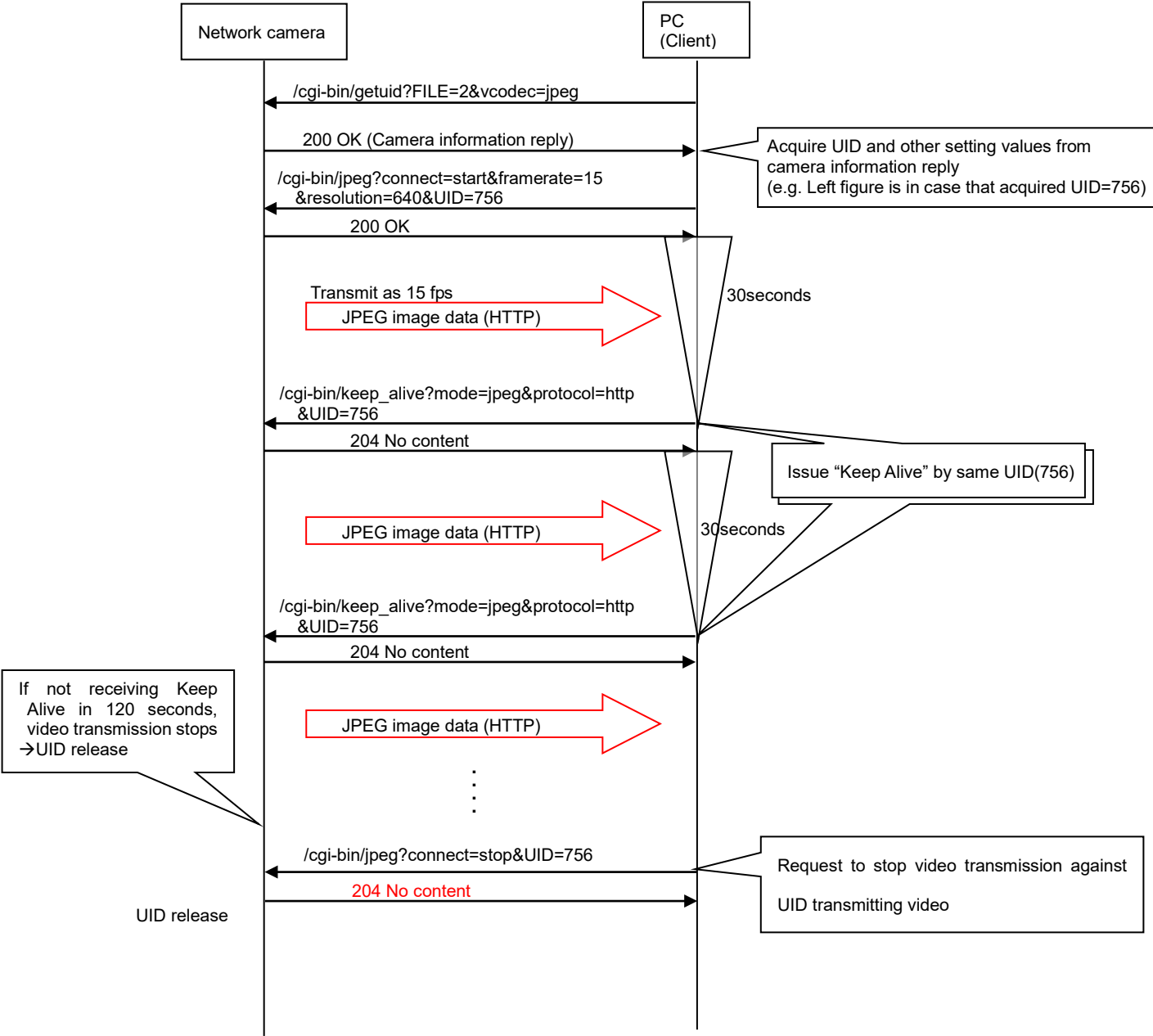
GET_PARAMETER rtsp://<ip address>/Src /MediaInput/h264/ RTSP/1.0
CSeq: 7
Session: 343003461131330550741819087776

(2) Response example

RTSP/1.0 200 OK
CSeq: 7
Connection: Keep-Alive
Session: 343003461131330550741819087776

2.4. JPEG transmission

2.4.1. JPEG sequence



2.4.2. Get UID (User management of video transmission)

[URL] /cgi-bin/getuid?FILE=2&vcodec=< Value>&reply=info[&ch=<Value>]

[Method] GET

[Access level] 3

Parameter name	Value	Comments
FILE	2 (fixed)	2 (fixed)
vcodec	jpeg, jpeg_2, jpeg_3	stream type jpeg : JPEG(1) stream jpeg_2 : JPEG(2) stream jpeg_3 : JPEG(3) stream
reply	info (fixed)	Response format info : for PC software (fixed)
ch	1, 2, 3, 4	Channel 1: Channel 1 2: Channel 2 3: Channel 3 4: Channel 4 #This parameter is supported by Multi-sensor models. When this parameter is omitted, it works as a channel 1.

2.4.3. JPEG start/stop transmission

[URL]

/cgi-bin/jpeg?connect=<Value>[&framerate=<Value>]&UID=<Value>[&stream=<Value>][&ch=<Value>]

[Method] GET

[Access level] 3

Parameter name	Value	Comments
connect	start stop	Transmit JPEG video stream start : start transmitting stop : stop transmitting(use for user ID which is already transmitting) [Note] This parameter can't be omitted.
framerate	0.1, 0.2 0.33, 0.5 1,2,3,5,6 10,12 15,30	Frame rate of stream specified from 0.1 to 30 fps #This parameter can be omitted.
UID	numerical value	User ID(acquired UID)
stream	1, 2,3	Specify the JPEG stream. 1 :JPEG(1) 2 :JPEG(2) 3 :JPEG(3) Default: 1 #This parameter can be omitted.
ch	1, 2, 3, 4	Channel 1: Channel 1 2: Channel 2 3: Channel 3 4: Channel 4 #This parameter is supported by Multi-sensor models. When this parameter is omitted, it works as a channel 1.

[Command example]

Start to transmit JPEG video stream (in case of 15fps, JPEG(1), user ID is 263)

<http://192.168.0.10/cgi-bin/jpeg?connect=start&framerate=15&stream=1&UID=263>

* Model: X8570, S8530 (Request to a channel 2)

<http://192.168.0.10/cgi-bin/jpeg?connect=start&framerate=15&stream=1&UID=263&ch=2>

2.4.4. Keep Alive

Please refer to chapter 2.2.7

2.5. JPEG transmission ("UID" is unnecessary)

[URL] /cgi-bin/mjpeg[?<Parameter name>=<Value>]

[Method] GET

[Access level] 3

Parameter name	Value	Comments
resolution	640x480, 640x360, 320x240, 320x180, 400x300, 800x600, 1280x960, 1280x720, 1600x1200, 1920x1080, 2048x1536, 2560x1920 2560x1440 3072x2304 3072x1728 3840x2160 640 x 640 320 x 320 1280 x 1280 2192 x 2192 2992 x 2992	Resolution When requested resolution is not set for JPEG(1), JPEG(2) or JPEG(3) on camera, camera transmit JPEG(1).
framerate	0.1, 0.2, 0.33 0.5, 1, 2, 3 5, 6, 10 12, 15, 30	Frame rate of stream specified from 0.1 to 30 fps
ch	1, 2, 3, 4	Channel 1: Channel 1 2: Channel 2 3: Channel 3 4: Channel 4 #This parameter is supported by Multi-sensor models. When this parameter is omitted, it works as a channel 1

[Command example]

Start to transmit JPEG video stream (in case of 15fps, VGA)

<http://192.168.0.10/cgi-bin/mjpeg?framerate=15&resolution=640x480>

* Model: X8570 (Request to a channel 2)

Start to transmit JPEG video stream (in case of 2fps, VGA)

<http://192.168.0.10/cgi-bin/mjpeg?framerate=2&resolution=640x480&ch=2>

2.6. Image Viewer

This command can be used to show video on HTML that user develop.

[URL] ImageViewer[?<Parameter name>=<Value>]

[Method] GET

[Access level] 3

Parameter name	Value	Comments
Mode	Motion, JPEG, JPEG_1, JPEG_2, JPEG_3, H264,H264_1, H264_2, H264_3, H264_4, H265,H265_1, H265_2, H265_3, H265_4	Image format Motion,JPEG,JPEG_1: JPEG(1) JPEG_2: JPEG(2) JPEG_3: JPEG(3) Refresh: Display still images. 'interval' is also needed. H264, H264_1, H.265, H.265_1 : Stream(1) H264_2, H.265_2 : Stream(2) H264_3, H.265_3 : Stream(3) H264_4, H.265_4 : Stream(4) #H.264 and H.265 can be used for IE only (plugin software is needed). Only Motion JPEG can be used by browsers other than IE. #This parameter can be omitted.(Default: JPEG(1))
Resolution	640x480, 640x360, 320x240, 320x180, 400x300, 800x600, 1280x960, 1280x720, 1600x1200, 1920x1080, 2048x1536, 2560x1920, 2560x1440, 3072x2304, 3072x1728 3840x2160 640x640, 320x320 1280x1280 2192x2192, 2992x2992	JPEG Resolution When requested resolution is not set for JPEG(1), JPEG(2) or JPEG(3) on camera, camera transmit JPEG(1). #This parameter can be used when 'Mode=JPEG' or 'Refresh'.
Interval	1,2,3,5,10	1,2,3,5,10 (Sec) #This parameter can be used when 'Mode=Refresh'.
Audio	on, off	PC side Audio output ON/OFF #Un-setting up and specification other than 'off' are set as 'on'. In the case of AudTool=1, a setup of this parameter is disregarded.
AudTool	1, 0	Audio control part On/Off 1:On, 0:Off(default)
View	Full Normal Full1	Full-screen display change Full : It displays to the limit of the Windows size of a browser. Normal : Usual display Full1 : Full-screen (It usually returns to a display by PC Esc key.)
CH	1,2,3,4	Channel 1: Channel 1, 2: Channel 2, 3: Channel 3, 4: Channel 4 #This parameter is supported by Multi-sensor models and "Quad stream" mode for fisheye camera.

[Command example]

Display motion images

<http://192.168.0.10/ImageViewer?Resolution=320x240&Quality=Standard&Mode=JPEG>

Display still images at a refresh rate of 1 per 5 seconds

<http://192.168.0.10/ImageViewer?Resolution=320x240&Quality=Standard&Mode=Refresh&Interval=5>

2.7. JPEG snapshot

[URL] /cgi-bin/camera?[resolution=<Value>][&stream=<Value>][&ch=<Value>]

[Method] GET

[Access level] 3

Parameter name	Value	Comments
resolution	640, 320, 1280, 2048 800, 1600 2560 3072 1920 3840 2192 2992	<p>Resolution to be set (4:3) 640 : VGA 320 : QVGA 1280 : 1280 x 960 2048 : 2048 x 1536 800 800 x 600 1600: 1600x1200 2560: 2560x1920 3072: 3072x2304</p> <p>Resolution to be set (16:9) 640 : 640 x 360 320 : 320 x 180 1280 : 1280 x 720 1920 : 1920 x 1080 2048 : 1920 x 1080 2560: 2560x1440 3072: 3072x1728 3840: 3840x2160</p> <p>Resolution to set (1:1) 640 : 640 x 640 320 : 320 x 320 1280 : 1280 x 1280 2192 : 2192 x 2192 2992 : 2992 x 2992</p> <p>When requested resolution is not set for JPEG(1), JPEG(2) or JPEG(3) on camera, camera transmit JPEG(1). #This parameter can be omitted. (Default: JPEG(1))</p>
stream	1, 2,3	Specify the JPEG stream. This parameter can be used instead of the parameter 'resolution' 1 :JPEG(1) , 2 :JPEG(2) ,3 :JPEG(3) #This parameter can be omitted. (Default: 1)
ch	1, 2, 3, 4	Channel 1: Channel 1 ,2: Channel 2 ,3: Channel 3 .4: Channel 4 #This parameter is supported by Multi-sensor models. When this parameter is omitted, it works as a channel 1

[Command example]

Request JPEG image as a one shot (Resolution: 640 x 480)

<http://192.168.0.10/cgi-bin/camera?resolution=640>

*Model: X8570 (Request to a channel 2)

<http://192.168.0.10/cgi-bin/camera?resolution=640&ch=2>

2.8. H.264/H.265 enforced I-frame insertion

[H.264]

[URL] [/cgi-bin/h264_l_insert ?\[stream=<Value>\]\[&ch=<Value>\]](#)

[Method] GET

[Access level] 3

Parameter name	Value	Comments
stream	1, 2, 3, 4	Specify the H.264 stream. 1 :Stream 1 ,2 :Stream 2 3 :Stream 3, 4 :Stream 4 * This parameter can be omitted. (Default: 1)
ch	1, 2, 3, 4	Channel 1: Channel 1, 2: Channel 2 3: Channel 3, 4: Channel 4 #This parameter is supported by Multi-sensor models and "Quad stream" mode for fisheye models. #This parameter can be omitted(Default: 1).

[Command example]

Enforced I-frame insertion

http://192.168.0.10/cgi-bin/h264_l_insert

[H.265]

[URL] [/cgi-bin/h265_l_insert ?\[stream=<Value>\]\[&ch=<Value>\]](#)

[Method] GET

[Access level] 3

Parameter name	Value	Comments
stream	1, 2, 3, 4	Specify the stream number 1 :Stream 1, 2 :Stream 2 3 :Stream 3, 4 :Stream 4 * This parameter can be omitted.(Default:1)
ch	1, 2, 3, 4	Channel 1: Channel 1, 2: Channel 2 3: Channel 3, 4: Channel 4 [Note] #This parameter is supported by Multi-sensor models and "Quad stream" mode for fisheye camera. #This parameter can be omitted(Default: 1).

[Command example]

Enforced I-frame insertion

http://192.168.0.10/cgi-bin/h265_l_insert

2.9. H.264/H.265 Multicast auto start mode

[Note]

To perform this function, 'multicast' must be set for 'Transmission type' setting.

[Stream(1)]

[URL] [/cgi-bin/set_h264?multicast_auto=<Value>](#)

[Method] GET

[Access level] 1

Parameter name	Value	Comments	Parameter to get current setting (/cgi-bin/getdata)
multicast_auto	0, 1	Multicast Auto Start ON/OFF 0: OFF , 1: ON	H264MLAUTO

[Stream(2)]

[URL] [/cgi-bin/set_h264_2?multicast_auto=<Value>](#)

[Method] GET

[Access level] 1

Parameter name	Value	Comments	Parameter to get current setting (/cgi-bin/getdata)
multicast_auto	0, 1	Multicast Auto Start ON/OF	H264MLAUTO_2

[Stream(3)]

[URL] [/cgi-bin/set_h264_3?multicast_auto=<Value>](#)

[Method] GET

[Access level] 1

Parameter name	Value	Comments	Parameter to get current setting (/cgi-bin/getdata)
multicast_auto	0, 1	Multicast Auto Start ON/OFF	H264MLAUTO_3

[Stream(4)]

[URL] [/cgi-bin/set_h264_4?multicast_auto=<Value>](#)

[Method] GET

[Access level] 1

Parameter name	Value	Comments	Parameter to get current setting (/cgi-bin/getdata)
multicast_auto	0, 1	Multicast Auto Start ON/OFF	H264MLAUTO_4

[Command example]

e.g.) Multicast auto start ON (Stream(1))

http://192.168.0.10/cgi-bin/set_h264?multicast_auto=1

2.10. Session management

[URL] /cgi-bin/man_session?command=<Value>[&uid=<Value>]

[Method] POST, GET

[Access level] 1

Parameter name	Value	Comments
command	release, get, release_all	Session management get : Get session information release: Release Target UID release_all: Release all UID.
uid		Target UID

[Command example]

Get current number of the session.

http://192.168.0.10/cgi-bin/man_session?command=get

The response format is described as below

(H.264 or H.265: 2 session, Audio(RTP): 2 session, MJPEG:2 session, Audio(HTTP):1 session,
Current UID used: 50000,50001,50002,50003,50004

```
-----  
HTTP/1.0 200 OK[CR][LF]  
Content-Type: text/plain[CR][LF]  
[CR][LF]  
H.264 session: 2[CR][LF]  
Audio(udp) session: 2[CR][LF]  
Jpeg session: 2[CR][LF]  
Audio(tcp) session: 1[CR][LF]  
[CR][LF]  
Used UID: 50000,50001,50002,50003,50004  
-----
```

Release UID 50000

http://192.168.0.10/cgi-bin/man_session?command=release&uid=50000

Release UID 0(multicast)

http://192.168.0.10/cgi-bin/man_session?command=release&uid=0

Release all UID

http://192.168.0.10/cgi-bin/man_session?command=release_all

2.11. Image capture mode setup

2.11.1. Image capture mode setup

[URL] /cgi-bin/set_imgmode?img_mode=<Value>&img_ratio=<Value>[&img_fps=<Value>]

[Method] POST

[Access level] 1

Parameter name	Value	Comments	Parameter to get current setting (/cgi-bin/getdata)
img_mode	1.3m, 2m, 3m, 5m, 8m_12_5, 8m_15, 8m_25, 8m_30 9m, 2688x1520 _25fps, 2688x1520 _30fps	Imaging mode 1.3m: 1.3Mega pixel mode 2m: 2Mega pixel mode 3m :3Mega pixel mode 5m: 5Mega pixel mode 8m_12_5: 8Mega pixel(12.5fps) mode 8m_15: 8Mega pixel (15 fps) mode 8m_25: 8Mega pixel(25fps) mode 8m_30: 8Mega pixel(30 fps) mode 9m: 9Mega pixel mode 2688x1520_25fps: 2688x1520 pixel (25 fps) mode 2688x1520_30fps: 2688x1520 pixel(30 fps) mode	IMAGESELECT
imgratio	4_3, 16_9	Aspect ratio 4_3 : 4:3 mode 16_9 : 16:9 mode	IMAGERATIO
img_fps	30, 60, 25, 50	Maximum framerate (fps) 30: 30fps mode 60: 60fps mode 25: 25fps mode 50: 50fps mode	IMAGEFPS

[Command example]

Set to 2 mega pixel,16:9 mode

http://192.168.0.10/cgi-bin/set_imgmode?img_mode=2m&imgratio=16_9

25fps mode and 50fps mode can be added to setup menu by using specific CGI.

Please refer to 9.7.

2.11.2. Capability information

CGI: /cgi-bin/get_capability

Related response: [video_server.image.mode=<Value>](#)

Value	Comments
-------	----------

Value	Comments
3m, 1_3m	Supported image capture mode 3m : 3 mega pixel 1_3m : 1.3 mega pixel
3m_r16_9, 1_3m_r16_9,	3m_r16_9: 3mega pixel(16:9) - 1080P 1_3m_r16_9: 1.3mega pixel (16:9)
2m 2m_r16_9	2m : 2 mega pixel [4:3] 2m_r16_9 : 2 mega pixel [16:9]
2m_r16_9_60fps	2m_r16_9_60fps: 2 mega pixel [16:9](60fpsmode)
9m, 9m_r16_9,	9m: 9m [4:3] 9m_r16_9: 9m [16:9]
9m_r1_1, 5m, 5m_r16_9,	9m_r1_1: 9m [1:1] 5m: 5m [4:3] 5m_r16_9: 5m [16:9]
5m_r1_1, 8m_15	5m_r1_1: 5m [1:1] 8m_15: 8 mega pixel[16:9] (15fps mode)
8m_30	8m_30: 8 mega pixel[16:9] (30fps mode)

2.11.3. Image capture mode setup for Fisheye camera

[URL] /cgi-bin/setdata?IMG_PATTERN=<Value>&LAYOUT=<Value>

[Method] GET/POST

[Access level] 1

Parameter name	Value	Comments	Parameter to get current setting (/cgi-bin/getdata)
IMG_PATTERN	fisheye, wpanorama, panorama, ptz_4, ptz_1, double_1_f, double_2_f, double_f_4, 4stream	Image type fisheye : Fisheye mode wpanorama: Double Panorama mode panorama : Panorama mode ptz_4 : Quad PTZ mode ptz_1 : Single PTZ mode double_2_f : Fisheye + Double Panorama mode double_1_f : Fisheye + Panorama mode double_f_4 : Fisheye + Quad PTZ mode 4stream : Quad streams mode #This parameter can't be omitted.	IMG_PATTERN
LAYOUT	ceiling, wall	Layout ceiling : Ceiling installation wall : Wall installation #This parameter can't be omitted.	LAYOUT

[Command list]

***Important:** Don't send the other combination of parameters which described in the following list.

Image capture mode	Command
1 Fisheye [1:1]	http://192.168.0.10/cgi-bin/setdata?&IMG_PATTERN=fisheye&LAYOUT=ceiling
2 Double Panorama [16:9] <Ceiling>	http://192.168.0.10/cgi-bin/setdata?&IMG_PATTERN=wpanorama&LAYOUT=ceiling
3 Panorama [16:9] <Wall>	http://192.168.0.10/cgi-bin/setdata?&IMG_PATTERN=panorama&LAYOUT=wall
4 Quad PTZ [4:3] <Ceiling><Wall>	http://192.168.0.10/cgi-bin/setdata?&IMG_PATTERN=ptz_4&LAYOUT=ceiling http://192.168.0.10/cgi-bin/setdata?&IMG_PATTERN=ptz_4&LAYOUT=wall

5	Single PTZ [4:3] <Ceiling><Wall>	<Ceiling> http://192.168.0.10/cgi-bin/setdata?&IMG_PATTERN=ptz_1&LAYOUT=ceiling <Wall> http://192.168.0.10/cgi-bin/setdata?&IMG_PATTERN=ptz_1&LAYOUT=wall
6	Fisheye[1:1] + Double Panorama[16:9] <Ceiling>	http://192.168.0.10/cgi-bin/setdata?&IMG_PATTERN=double_2_f&LAYOUT=ceiling
7	Fisheye[1:1] + Panorama[16:9] <Wall>	http://192.168.0.10/cgi-bin/setdata?&IMG_PATTERN=double_1_f&LAYOUT=wall
8	Fisheye[1:1] + Quad PTZ[4:3] <Ceiling>	http://192.168.0.10/cgi-bin/setdata?&IMG_PATTERN=double_f_4&LAYOUT=ceiling
9	Quad stream <Ceiling>	http://192.168.0.10/cgi-bin/setdata?&IMG_PATTERN=4stream&LAYOUT=ceiling

[Description of 9M(X4x7x Series)]

The following types of images can be transmitted in each "Image capture mode" setting.


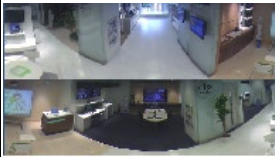

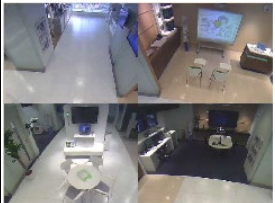

Image capture mode		Explanation
1	9M fisheye [1:1]	<p>Fisheye images are transmitted. (Max. 30fps) The maximum image capture size that can be configured is 9 megapixel (2992(H) x 2992(V)).</p> 
2	Double Panorama [16:9] <Ceiling>	<p>Double Panorama images are transmitted. (Max. 15fps) The maximum image capture size that can be configured is 3.5 megapixel (2560(H) x 1440(V)).</p> 
3	Panorama [16:9] <Wall>	<p>Panorama images are transmitted. (Max. 15fps) The maximum image capture size that can be configured is 3.5 megapixel (2560(H) x 1440(V)).</p> 
4	Quad PTZ [4:3] <Ceiling><Wall>	<p>Quad PTZ images are transmitted. (Max. 15fps) The maximum image capture size that can be configured is 5 megapixel (2560(H) x 1920(V)).</p> 
5	Single PTZ [4:3] <Ceiling><Wall>	<p>Single PTZ images are transmitted. (Max. 15fps) The maximum image capture size that can be configured is 5 megapixel (2560(H) x 1920(V)).</p> 







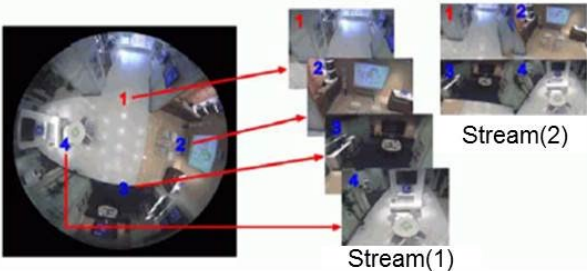
Image capture mode		Explanation
6	9MFisheye[1:1] + Double Panorama[16:9] <Ceiling>	<p>Fisheye images and Double Panorama can be transmitted at the same time. (Max. 15fps)</p> <p>The maximum image capture size that can be configured for Fisheye images is 9 megapixel (2992(H) x 2992(V)), and for Double Panorama images is 1 megapixel (1280(H) x 720(V)).</p>   <p>Stream(1) Stream (2)</p>
7	9MFisheye[1:1] + Panorama[16:9] <Wall>	<p>Fisheye images and Panorama images can be transmitted at the same time. (Max. 15fps)</p> <p>The maximum image capture size that can be configured for Fisheye images is 9 megapixel (2992(H) x 2992(V)), and for Panorama images is 1 megapixel (1280(H) x 720(V)).</p>   <p>Stream (1) Stream (2)</p>
8	9MFisheye[1:1] + Quad PTZ[4:3] <Ceiling><Wall>	<p>Fisheye images and Quad PTZ images can be transmitted at the same time. (Max. 15fps)</p> <p>The maximum image capture size that can be configured for Fisheye images is 9 megapixel (2992(H) x 2992(V)), and for Quad PTZ images is 1.3 megapixel (1280(H) x 960(V)).</p>   <p>Stream (1) Stream (2)</p>
9	Quad stream <Ceiling>	<p>4 types of Single PTZ images can be transmitted. (max. 15fps)</p> <p>A single screen image containing the 4 types of images combined together can also be transmitted. (max. 5fps)</p> <p>Only H.264 or H.265 images can be sent.</p> <p>The maximum image capture size that can be configured for Single PTZ (Quad stream) is 1.3 megapixel (1280(H) x 960(V)), and for Quad stream is 5 megapixel (2560(H) x 1920(V)).</p>  <p>Stream(2)</p> <p>Stream(1)</p>

Image capture mode	Stream(1)	Stream(2)	JPEG(1)	JPEG(2)
9M fisheye [1:1]	Fisheye: 2992x2992 2192x2192 1280x1280 640x640 320x320	Fisheye: 1280x1280 640x640 320x320	Fisheye: 2992x2992 2192x2192 1280x1280 640x640 320x320	Fisheye: 1280x1280 640x640 320x320
Double Panorama [16:9] <Ceiling>	DoublePanorama: 2560x1440 1920x1080 1280x720 640x360 320x180	DoublePanorama: 1920x1080 1280x720 640x360 320x180	DoublePanorama: 2560x1440 1920x1080 1280x720 640x360 320x180	DoublePanorama: 1920x1080 1280x720 640x360 320x180
Panorama [16:9] <Wall>	Panorama: 2560x1440 1920x1080 1280x720 640x360 320x180	Panorama: 1920x1080 1280x720 640x360 320x180	Panorama: 2560x1440 1920x1080 1280x720 640x360 320x180	Panorama: 1920x1080 1280x720 640x360 320x180
Quad PTZ [4:3] <Ceiling><Wall>	Quad PTZ: 2560x1920 2048x1536 1600x1200 1280x960 800x600 VGA QVGA	Quad PTZ: 1280x960 800x600 VGA QVGA	Quad PTZ: 2560x1920 2048x1536 1600x1200 1280x960 800x600 VGA QVGA	Quad PTZ: 1280x960 800x600 VGA QVGA
Single PTZ [4:3] <Ceiling><Wall>	Single PTZ: 2560x1920 2048x1536 1600x1200 1280x960 800x600 VGA QVGA	Single PTZ: 1280x960 800x600 VGA QVGA	Single PTZ: 2560x1920 2048x1536 1600x1200 1280x960 800x600 VGA QVGA	Single PTZ: 1280x960 800x600 VGA QVGA
9MFisheye[1:1] + Double Panorama[16:9] <Ceiling>	Fisheye: 2992x2992 2192x2192 1280x1280 640x640 320x320	DoublePanorama: 1280x720 640x360 320x180	Fisheye: 2992x2992 2192x2192 1280x1280 640x640 320x320	DoublePanorama: 1280x720 640x360 320x180
9MFisheye[1:1] + Panorama[16:9] <Wall>	Fisheye: 2992x2992 2192x2192 1280x1280 640x640 320x320	Panorama: 1280x720 640x360 320x180	Fisheye: 2992x2992 2192x2192 1280x1280 640x640 320x320	Panorama: 1280x720 640x360 320x180
9MFisheye[1:1] + Quad PTZ[4:3] <Ceiling><Wall>	Fisheye: 2992x2992 2192x2192 1280x1280 640x640 320x320	Quad PTZ: 1280x960 800x600 VGA QVGA	Fisheye: 2992x2992 2192x2192 1280x1280 640x640 320x320	Quad PTZ: 1280x960 800x600 VGA QVGA
Quad stream <Ceiling>	1CH - 4CH 1280x960 800x600 VGA QVGA	Quad PTZ: 2560x1920 2048x1536 1600x1200 1280x960 800x600 VGA QVGA	-	-

[Description of 5M(S4x50 Series)]

The following types of images can be transmitted in each "Image capture mode" setting.


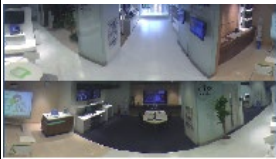

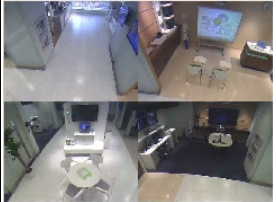

Image capture mode		Explanation
1	5M fisheye [1:1]	<p>Fisheye images are transmitted. (Max. 30fps) The maximum image capture size that can be configured is 5 megapixel (2192(H) x 2192(V)).</p> 
2	Double Panorama [16:9] <Ceiling>	<p>Double Panorama images are transmitted. (Max. 30fps) The maximum image capture size that can be configured is 2.0 megapixel (1920(H) x 1080(V)).</p> 
3	Panorama [16:9] <Wall>	<p>Panorama images are transmitted. (Max. 30fps) The maximum image capture size that can be configured is 2.0 megapixel (1920(H) x 1080(V)).</p> 
4	Quad PTZ [4:3] <Ceiling><Wall>	<p>Quad PTZ images are transmitted. (Max. 30fps) The maximum image capture size that can be configured is 2 megapixel (1600(H) x 1200(V)).</p> 
5	Single PTZ [4:3] <Ceiling><Wall>	<p>Single PTZ images are transmitted. (Max. 30fps) The maximum image capture size that can be configured is 2 megapixel (1600(H) x 1200(V)).</p> 


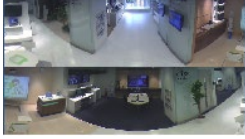



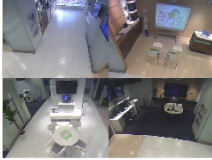
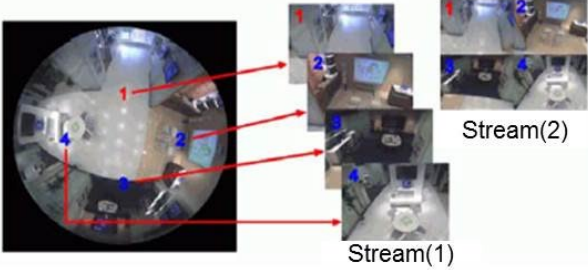
Image capture mode		Explanation
6	5MFisheye[1:1] + Double Panorama[16:9] <Ceiling>	<p>Fisheye images and Double Panorama can be transmitted at the same time. (Max. 30fps)</p> <p>The maximum image capture size that can be configured for Fisheye images is 5 megapixel (2192(H) x 2192(V)), and for Double Panorama images is 1 megapixel (1280(H) x 720(V)).</p>   <p>Stream (1) Stream (2)</p>
7	5MFisheye[1:1] + Panorama[16:9] <Wall>	<p>Fisheye images and Panorama images can be transmitted at the same time. (Max. 30fps)</p> <p>The maximum image capture size that can be configured for Fisheye images is 5 megapixel (2192(H) x 2192(V)), and for Panorama images is 1 megapixel (1280(H) x 720(V)).</p>   <p>Stream (1) Stream (2)</p>
8	5MFisheye[1:1] + Quad PTZ[4:3] <Ceiling><Wall>	<p>Fisheye images and Quad PTZ images can be transmitted at the same time. (Max. 30fps)</p> <p>The maximum image capture size that can be configured for Fisheye images is 5 megapixel (2192(H) x 2192(V)), and for Quad PTZ images is 1.3 megapixel (1280(H) x 960(V)).</p>   <p>Stream (1) Stream (2)</p>
9	Quad stream <Ceiling>	<p>4 types of Single PTZ images can be transmitted. (max. 30fps)</p> <p>A single screen image containing the 4 types of images combined together can also be transmitted. (max. 5fps)</p> <p>Only H.264 or H.265 images can be sent.</p> <p>The maximum image capture size that can be configured for Single PTZ (Quad stream) is 1.3 megapixel (1280(H) x 960(V)), and for Quad stream is 2.0 megapixel (1600(H) x 1200(V)).</p>  <p>Stream(2)</p> <p>Stream(1)</p>

Image capture mode	Stream (1)	Stream (2)	JPEG(1)	JPEG(2)
5M fisheye [1:1]	Fisheye: 2192x2192 1280x1280 640x640 320x320	Fisheye: 1280x1280 640x640 320x320	Fisheye: 2192x2192 1280x1280 640x640 320x320	Fisheye: 1280x1280 640x640 320x320
Double Panorama [16:9] <Ceiling>	DoublePanorama: 1920x1080 1280x720 640x360 320x180	DoublePanorama: 1280x720 640x360 320x180	DoublePanorama: 1920x1080 1280x720 640x360 320x180	DoublePanorama: 1280x720 640x360 320x180
Panorama [16:9] <Wall>	Panorama: 1920x1080 1280x720 640x360 320x180	Panorama: 1280x720 640x360 320x180	Panorama: 1920x1080 1280x720 640x360 320x180	Panorama: 1280x720 640x360 320x180
Quad PTZ [4:3] <Ceiling><Wall>	Quad PTZ: 1600x1200 1280x960 800x600 VGA QVGA	Quad PTZ: 1280x960 VGA QVGA	Quad PTZ: 1600x1200 1280x960 800x600 VGA QVGA	Quad PTZ: 1280x960 VGA QVGA
Single PTZ [4:3] <Ceiling><Wall>	Single PTZ: 1600x1200 1280x960 800x600 VGA QVGA	Single PTZ: 1280x960 VGA QVGA	Single PTZ: 1600x1200 1280x960 800x600 VGA QVGA	Single PTZ: 1280x960 VGA QVGA
5MFisheye[1:1] + Double Panorama[16:9] <Ceiling>	Fisheye: 2192x2192 1280x1280 640x640 320x320	DoublePanorama: 1280x720 640x360 320x180	Fisheye: 2192x2192 1280x1280 640x640 320x320	DoublePanorama: 1280x720 640x360 320x180
5MFisheye[1:1] + Panorama[16:9] <Wall>	Fisheye: 2192x2192 1280x1280 640x640 320x320	Panorama: 1280x720 640x360 320x180	Fisheye: 2192x2192 1280x1280 640x640 320x320	Panorama: 1280x720 640x360 320x180
5MFisheye[1:1] + Quad PTZ[4:3] <Ceiling><Wall>	Fisheye: 2192x2192 1280x1280 640x640 320x320	Quad PTZ: 1280x960 800x600 VGA QVGA	Fisheye: 2192x2192 1280x1280 640x640 320x320	Quad PTZ: 1280x960 800x600 VGA QVGA
Quad stream <Ceiling>	1CH - 4CH 1280x960 800x600 VGA QVGA	Quad PTZ: 1600x1200 1280x960 800x600 VGA QVGA	-	-

2.11.4. Capability information for Fisheye camera

CGI: /cgi-bin/get_capability

Related response: video_server.image.mode_fisheye=<Value>

Value	Comments
[1 monitor mode] wpanorama, QuadPTZ, SinglePTZ, panorama, 9m_fisheye, 5m_fisheye,	Supported capture mode for the fisheye camera. [1 monitor mode] wpanorama: Double Panorama QuadPTZ: Quad PTZ <Ceiling> or <Wall> SinglePTZ: Single PTZ <Ceiling> or <Wall> panorama: Panorama 9m_fisheye: 9M Fisheye 5m_fisheye: 5M Fisheye
[2 monitor mode] 9m_fisheye_wpanorama, 5m_fisheye_wpanorama, 9m_fisheye_panorama, 5m_fisheye_panorama, 9m_fisheye_QuadPTZ, 5m_fisheye_QuadPTZ,	[2 monitor mode] 9m_fisheye_wpanorama: 9MFisheye + Double Panorama 5m_fisheye_wpanorama: 5MFisheye + Double Panorama 9m_fisheye_panorama: 9MFisheye + Panorama 5m_fisheye_panorama: 5MFisheye + Panorama 9m_fisheye_QuadPTZ: 9MFisheye + QuadPTZ 5m_fisheye_QuadPTZ: 5MFisheye + QuadPTZ
[Quad stream] 4stream	[Quad stream] 4stream: Quad streams

2.12. H.264/H.265 setup

2.12.1. Stream(1)

[URL] /cgi-bin/set_h264? [<Parameter name>=<Value>][&ch=<Value>]

[Method] POST

[Access level] 1

Parameter name	Value	Comments	Parameter to get current setting (/cgi-bin/getdata)
h264_transmit	0, 1	H.264 /H.265 transmission 0: OFF, 1: ON	H264
encode_type	1,2	Encode type(*1) 1: H.264, 2: H.265	STREAMENCMODE
h264_resolution	320 400 640 800 1280 1600 1920 2048 3072 2560 3840 2192 2992	H.264 /H.265 Resolution (4:3) 320: QVGA 400:400x300 640: VGA 800: 800x600 1280: 1280x960 1600: 1600x1200 2048: 2048x1536 2560: 2560x1920 3072: 3072x2304 (16:9) 320: 320x180 640: 640x360 1280: 1280x720 1920: 1920x1080 2560: 2560x1440 3072: 3072x1728 3840: 3840x2160 (1:1) 640 : 640 x 640 320 : 320 x 320 1280 : 1280 x 1280 2192 : 2192 x 2192 2992 : 2992 x 2992	H264SIZE
f_priority	0, 1, 2, 4	H.264 /H.265 stream priority 0: Bit rate priority 1: Frame rate priority 2: Best effort mode 4: VBR	H264FPRIORITY

Parameter name	Value	Comments	Parameter to get current setting (/cgi-bin/getdata)
nr_framerate	1, 3, 5, 7.5, 10, 12, 15, 20, 30, 60	H.264 /H.265 Framerate 1: 1 fps 3: 3 fps / 3.1 fps 5: 5 fps / 4.2 fps 7.5: 7.5 fps / 6.25fps 10: 10 fps / 8.3fps 12: 12 fps / 12.5fps 15: 15 fps 20: 20 fps 30: 30 fps,25 fps 60: 60 fps The value of framerate might be different when corresponding to same value in case of different image mode	H264NRFRAMERATE
h264_bandwidth	64, 128, 256, 384, 512, 768, 1024, 1536, 2048, 3072, 4096, 6144, 8192, 10240, 12288, 14336, 16384, 20480, 24576,	H.264 /H.265 bandwidth 64: 64kbps, 128: 128 kbps, 256: 256 kbps, 384: 384 kbps, 512: 512 kbps, 768: 768 kbps, 1024: 1024 kbps, 1536: 1536 kbps, 2048: 2048 kbps, 3072: 3072 kbps, 4096: 4096 kbps, 6144: 6144 kbps, 8192: 8192 kbps, 10240: 10240kbps, 12288: 12288kbps, 14336: 14336kbps, 16384: 16384 kbps 20480: 20480 kbps 24576: 24576 kbps	H264BWC
h264_quality	fine, normal, low 0, 1, 2, 3, 4, 5,6, 7, 8, 9	H.264 /H.265 quality fine: Fine normal: Normal low: Low 0, 1, 2, 3, 4, 5, 6, 7, 8, 9 : 10 step setting when VBR	H264QUAL
h264_ivop	0.2, 0.25 0.33, 0.5, 1, 2, 3, 4, 5	H.264 /H.265 Ivop insertion interval 0.2: 0.2 sec 0.25 :0.25 sec 0.33: 0.33 sec 0.5: 0.5 sec 1: 1 sec 2: 2 sec 3: 3 sec 4: 4 sec 5: 5 sec	H264RINT
h264_unimulti	uni, multi, uni_manual	Transmission type uni: unicast(auto) multi: multicast uni_manual: unicast(manual)	H264MTD
multicast_addr1	224 to 239	H.264/H.265 multicast address 1st octet	H264MLADD1
multicast_addr2	0 to 255	H.264/H.265 multicast address 2nd octet	H264MLADD2

Parameter name	Value	Comments	Parameter to get current setting (/cgi-bin/getdata)
multicast_addr3	0 to 255	H.264/H.265 multicast address 3rd octet	H264MLADD3
multicast_addr4	0 to 255	H.264/H.265 multicast address 4th octet	H264MLADD4
multicast_addr	(IPv4 address) or (IPv6 address)	H.264/H.265 multicast address	H264MLADD
multicast_port	1024 to 50000	H.264 /H.265 multicast port number	H264MLPORT
multicast_ttl	1 to 254	H.264 /H.265 multicast TTL	H264MLTTL
ch	1, 2, 3, 4	Channel 1: Channel 1 2: Channel 2 3: Channel 3 4: Channel 4 #This parameter is supported by Multi-sensor models. When this parameter is omitted, it works as all channel.	refer to chapter 2.12.3

[Command example]

Change the H.264 resolution to 640x480.

http://192.168.0.10/cgi-bin/set_h264?h264_resolution=640

Change the H.264 quality to low

http://192.168.0.10/cgi-bin/set_h264?h264_quality=low

Change the H.264 quality to normal, bandwidth to 1024kbps

http://192.168.0.10/cgi-bin/set_h264?h264_quality=normal&h264_bandwidth=1024

Set H.264 multicast address to 224.0.50.102 and port number: 32002

http://192.168.0.10/cgi-bin/set_h264?multicast_addr1=224&multicast_addr2=0&multicast_addr3=50&multicast_addr4=102&multicast_port=32002

*1 Encode type can be also changed by following CGI

[URL] [/cgi-bin/setdata? \[<Parameter name>=<Value>\]](#)

[Method] GET/POST

[Access level] 1

Parameter name	Value	Comments
ENCODE_TYPE	1, 2	Encode type of the stream 1. 1: H.264, 2: H.265
ENCODE_TYPE_2	1, 2	Encode type of the stream 2
ENCODE_TYPE_3	1, 2	Encode type of the stream 3
ENCODE_TYPE_4	1, 2	Encode type of the stream 4

e.g.) Set stream 1 to H.264

http://192.168.0.10/cgi-bin/setdata?ENCODE_TYPE=1

2.12.2. Stream(2)/Stream(3)/Stream(4)

[Stream 2]

[URL] /cgi-bin/set_h264_2? [<Parameter name>=<Value>][&ch=<Value>]

[Method] POST

[Access level] 1

Parameter name	Value	Parameter to get current setting (/cgi-bin/getdata)
h264_transmit	refer to Stream(1)	H264_2
encode_type	refer to Stream(1)	STREAMENCMODE_2
h264_resolution	refer to Stream(1)	H264SIZE_2
f_priority	refer to Stream(1)	H264FPRIORITY_2
nr_framerate	refer to Stream(1)	H264NRFRAMERATE_2
h264_bandwidth	refer to Stream(1)	H264BWC_2
h264_quality	refer to Stream(1)	H264QUAL_2
h264_ivop	refer to Stream(1)	H264RINT_2
h264_unimulti	refer to Stream(1)	H264MTD_2
multicast_addr1	refer to Stream(1)	H264MLADD1_2
multicast_addr2	refer to Stream(1)	H264MLADD2_2
multicast_addr3	refer to Stream(1)	H264MLADD3_2
multicast_addr4	refer to Stream(1)	H264MLADD4_2
multicast_addr	refer to Stream(1)	H264MLADD_2
multicast_port	refer to Stream(1)	H264MLPORT_2
multicast_ttl	refer to Stream(1)	H264MLTTL_2
ch	refer to Stream(1)	refer to chapter 2.12.3

[Command example]

Change the H.264 second stream resolution to 640x480.

http://192.168.0.10/cgi-bin/set_h264_2?h264_resolution=640

Change the H.264 second stream quality to low

http://192.168.0.10/cgi-bin/set_h264_2?h264_quality=low

Change the H.264 second stream quality to normal, bandwidth to 1024kbps

http://192.168.0.10/cgi-bin/set_h264_2?h264_quality=normal&h264_bandwidth=1024

Set H.264 second stream multicast address to 224.0.50.102 and port number: 32002

http://192.168.0.10/cgi-bin/set_h264_2?multicast_addr1=224&multicast_addr2=0&multicast_addr3=50&multicast_addr4=102&multicast_port=32002

[Stream 3]

[URL] /cgi-bin/set_h264_3? [<Parameter name>=<Value>][&ch=<Value>]

[Method] POST

[Access level] 1

Parameter name	Value	Parameter to get current setting (/cgi-bin/getdata)
h264_transmit	refer to Stream(1)	H264_3
encode_type	refer to Stream(1)	STREAMENCMODE_3
h264_resolution	refer to Stream(1)	H264SIZE_3
f_priority	refer to Stream(1)	H264FPRIORITY_3
nr_framerate	refer to Stream(1)	H264NRFRAMERATE_3
h264_bandwidth	refer to Stream(1)	H264BWC_3
h264_quality	refer to Stream(1)	H264QUAL_3
h264_ivop	refer to Stream(1)	H264RINT_3
h264_unimulti	refer to Stream(1)	H264MTD_3
multicast_addr1	refer to Stream(1)	H264MLADD1_3
multicast_addr2	refer to Stream(1)	H264MLADD2_3
multicast_addr3	refer to Stream(1)	H264MLADD3_3
multicast_addr4	refer to Stream(1)	H264MLADD4_3
multicast_addr	refer to Stream(1)	H264MLADD_3
multicast_port	refer to Stream(1)	H264MLPORT_3
multicast_ttl	refer to Stream(1)	H264MLTTL_3
ch	refer to Stream(1)	refer to chapter 2.12.3

[Command example]

Change the H.264 resolution to 640x480.

http://192.168.0.10/cgi-bin/set_h264_3?h264_resolution=640

Change the H.264 quality to low

http://192.168.0.10/cgi-bin/set_h264_3?h264_quality=low

Change the H.264 quality to normal, bandwidth to 1024kbps

http://192.168.0.10/cgi-bin/set_h264_3?h264_quality=normal&h264_bandwidth=1024

Set H.264 multicast address to 224.0.50.102 and port number: 32002

http://192.168.0.10/cgi-bin/set_h264_3?multicast_addr1=224&multicast_addr2=0&multicast_addr3=50&multicast_addr4=102&multicast_port=32002

[Stream 4]

[URL] /cgi-bin/set_h264_4? [<Parameter name>=<Value>][&ch=<Value>]

[Method] POST

[Access level] 1

Parameter name	Value	Parameter to get current setting (/cgi-bin/getdata)
h264_transmit	refer to Stream(1)	H264_4
encode_type	refer to Stream(1)	STREAMENCMODE_4
h264_resolution	refer to Stream(1)	H264SIZE_4
f_priority	refer to Stream(1)	H264FPRIORITY_4
nr_framerate	refer to Stream(1)	H264NRFRAMERATE_4
h264_bandwidth	refer to Stream(1)	H264BWC_4
h264_quality	refer to Stream(1)	H264QUAL_4
h264_ivop	refer to Stream(1)	H264RINT_4
h264_unimulti	refer to Stream(1)	H264MTD_4
multicast_addr1	refer to Stream(1)	H264MLADD1_4
multicast_addr2	refer to Stream(1)	H264MLADD2_4
multicast_addr3	refer to Stream(1)	H264MLADD3_4
multicast_addr4	refer to Stream(1)	H264MLADD4_4
multicast_addr	refer to Stream(1)	H264MLADD_4
multicast_port	refer to Stream(1)	H264MLPORT_4
multicast_ttl	refer to Stream(1)	H264MLTTL_4
ch	refer to Stream(1)	refer to sectoin 2.12.3

[Command example]

Change the H.264 resolution to 640x480.

http://192.168.0.10/cgi-bin/set_h264_4?h264_resolution=640

Change the H.264 quality to low

http://192.168.0.10/cgi-bin/set_h264_4?h264_quality=low

Change the H.264 quality to normal, bandwidth to 1024kbps

http://192.168.0.10/cgi-bin/set_h264_4?h264_quality=normal&h264_bandwidth=1024

Change the H.264 unicast port number to 3072

http://192.168.0.10/cgi-bin/set_h264_4?unicast_port=3072

Set H.264 multicast address to 224.0.50.102 and port number: 32002

http://192.168.0.10/cgi-bin/set_h264_4?multicast_addr1=224&multicast_addr2=0&multicast_addr3=50&multicast_addr4=102&multicast_port=32002

2.12.3. Get current settings for Multi-sensor models

CGI: /cgi-bin/getdata

Parameter name	Comments
H264_CH1	STREAM(1) transmission(ch1) 0: OFF, 1: ON
H264_CH2	STREAM(1) transmission(ch2)
H264_CH3	STREAM(1) transmission(ch3)
H264_CH4	STREAM(1) transmission(ch4)
H264BWC_CH1	STREAM(1) bandwidth(ch1)
H264BWC_CH2	STREAM(1) bandwidth(ch2)
H264BWC_CH3	STREAM(1) bandwidth(ch3)
H264BWC_CH4	STREAM(1) bandwidth(ch4)
H264SIZE_CH1	STREAM(1) resolution(ch1)
H264SIZE_CH2	STREAM(1) resolution(ch2)
H264SIZE_CH3	STREAM(1) resolution(ch3)
H264SIZE_CH4	STREAM(1) resolution(ch4)
H264FPRIORITY_CH1	STREAM(1) stream priority (ch1) 0: Bit rate priority, 1: Frame rate priority 2: Best effort mode, 4: VBR
H264FPRIORITY_CH2	STREAM(1) stream priority (ch2)
H264FPRIORITY_CH3	STREAM(1) stream priority (ch3)
H264FPRIORITY_CH4	STREAM(1) stream priority (ch4)
H264NRFRAMERATE_CH1	Framerate (STREAM(1))(ch1)
H264NRFRAMERATE_CH2	Framerate (STREAM(1))(ch2)
H264NRFRAMERATE_CH3	Framerate (STREAM(1))(ch3)
H264NRFRAMERATE_CH4	Framerate (STREAM(1))(ch4)
H264QUAL_CH1	STREAM(1) quality (ch1)
H264QUAL_CH2	STREAM(1) quality (ch2)
H264QUAL_CH3	STREAM(1) quality (ch3)
H264QUAL_CH4	STREAM(1) quality (ch4)
H264RINT_CH1	STREAM(1) Ivp insertion interval (ch1)
H264RINT_CH2	STREAM(1) Ivp insertion interval (ch2)
H264RINT_CH3	STREAM(1) Ivp insertion interval (ch3)
H264RINT_CH4	STREAM(1) Ivp insertion interval (ch4)
H264MTD_CH1	STREAM(1) transmission type (ch1)
H264MTD_CH2	STREAM(1) transmission type (ch2)
H264MTD_CH3	STREAM(1) transmission type (ch3)
H264MTD_CH4	STREAM(1) transmission type (ch4)
H264MLADD1	Multicast address 1st octet (STREAM(1)) 224 to 239
H264MLADD2	Multicast address 2nd octet (STREAM(1)) 0 to 255
H264MLADD3	Multicast address 3rd octet (STREAM(1)) 0 to 255
H264MLADD4	Multicast address 4th octet (STREAM(1)) 0 to 255
H264MLADD1CH2	Multicast address 1st octet (STREAM(1) Ch2) 224 to 239
H264MLADD2CH2	Multicast address 2nd octet (STREAM(1) Ch2) 0 to 255
H264MLADD3CH2	Multicast address 3rd octet (STREAM(1) Ch2) 0 to 255
H264MLADD4CH2	Multicast address 4th octet (STREAM(1) Ch2) 0 to 255
H264MLADD1CH3	Multicast address 1st octet (STREAM(1) Ch3) 224 to 239
H264MLADD2CH3	Multicast address 2nd octet (STREAM(1) Ch3) 0 to 255
H264MLADD3CH3	Multicast address 3rd octet (STREAM(1) Ch3) 0 to 255
H264MLADD4CH3	Multicast address 4th octet (STREAM(1) Ch3) 0 to 255
H264MLADD1CH4	Multicast address 1st octet (STREAM(1) Ch4) 224 to 239
H264MLADD2CH4	Multicast address 2nd octet (STREAM(1) Ch4) 0 to 255
H264MLADD3CH4	Multicast address 3rd octet (STREAM(1) Ch4) 0 to 255
H264MLADD4CH4	Multicast address 4th octet (STREAM(1) Ch4) 0 to 255

Parameter name	Comments
H264MLADD_1_CH1	STREAM(1) multicast address (ch1)
H264MLADD_1_CH2	STREAM(1) multicast address (ch2)
H264MLADD_1_CH3	STREAM(1) multicast address (ch3)
H264MLADD_1_CH4	STREAM(1) multicast address (ch4)
H264MLPORT_CH1	Multicast port(STREAM(1)) (ch1)
H264MLPORT_CH2	Multicast port(STREAM(1)) (ch2)
H264MLPORT_CH3	Multicast port(STREAM(1)) (ch3)
H264MLPORT_CH4	Multicast port(STREAM(1)) (ch4)
H264_2_CH1	STREAM(2) transmission(ch1)
H264_2_CH2	STREAM(2) transmission(ch2)
H264_2_CH3	STREAM(2) transmission(ch3)
H264_2_CH4	STREAM(2) transmission(ch4)
H264BWC_2_CH1	STREAM(2) bandwidth (ch1)
H264BWC_2_CH2	STREAM(2) bandwidth (ch2)
H264BWC_2_CH3	STREAM(2) bandwidth (ch3)
H264BWC_2_CH4	STREAM(2) bandwidth (ch4)
H264SIZE_2_CH1	STREAM(2) resolution (ch1)
H264SIZE_2_CH2	STREAM(2) resolution (ch2)
H264SIZE_2_CH3	STREAM(2) resolution (ch3)
H264SIZE_2_CH4	STREAM(2) resolution (ch4)
H264FPRIORITY_2_CH1	STREAM(2) stream priority(ch1)
H264FPRIORITY_2_CH2	STREAM(2) stream priority(ch2)
H264FPRIORITY_2_CH3	STREAM(2) stream priority(ch3)
H264FPRIORITY_2_CH4	STREAM(2) stream priority(ch4)
H264NRFRAMERATE_2_CH1	Framerate (STREAM(2))(ch1)
H264NRFRAMERATE_2_CH2	Framerate (STREAM(2))(ch2)
H264NRFRAMERATE_2_CH3	Framerate (STREAM(2))(ch3)
H264NRFRAMERATE_2_CH4	Framerate (STREAM(2))(ch4)
H264QUAL_2_CH1	STREAM(2) quality (ch1)
H264QUAL_2_CH2	STREAM(2) quality (ch2)
H264QUAL_2_CH3	STREAM(2) quality (ch3)
H264QUAL_2_CH4	STREAM(2) quality (ch4)
H264RINT_2_CH1	Ivop insertion interval (STREAM(2)) (ch1)
H264RINT_2_CH2	Ivop insertion interval (STREAM(2)) (ch2)
H264RINT_2_CH3	Ivop insertion interval (STREAM(2)) (ch3)
H264RINT_2_CH4	Ivop insertion interval (STREAM(2)) (ch4)
H264MTD_2_CH1	Transmission type (STREAM(2)) (ch1)
H264MTD_2_CH2	Transmission type (STREAM(2)) (ch2)
H264MTD_2_CH3	Transmission type (STREAM(2)) (ch3)
H264MTD_2_CH4	Transmission type (STREAM(2)) (ch4)
H264MLADD1_2	Multicast address 1st octet (STREAM(2)) 224 to 239
H264MLADD2_2	Multicast address 2nd octet (STREAM(2)) 0 to 255
H264MLADD3_2	Multicast address 3rd octet (STREAM(2)) 0 to 255
H264MLADD4_2	Multicast address 4th octet (STREAM(2)) 0 to 255
H264MLADD1CH2_2	Multicast address 1st octet (STREAM(2) Ch2) 224 to 239
H264MLADD2CH2_2	Multicast address 2nd octet (STREAM(2) Ch2) 0 to 255
H264MLADD3CH2_2	Multicast address 3rd octet (STREAM(2) Ch2) 0 to 255
H264MLADD4CH2_2	Multicast address 4th octet (STREAM(2) Ch2) 0 to 255
H264MLADD1CH3_2	Multicast address 1st octet (STREAM(2) Ch3) 224 to 239
H264MLADD2CH3_2	Multicast address 2nd octet (STREAM(2) Ch3) 0 to 255
H264MLADD3CH3_2	Multicast address 3rd octet (STREAM(2) Ch3) 0 to 255
H264MLADD4CH3_2	Multicast address 4th octet (STREAM(2) Ch3) 0 to 255
H264MLADD1CH4_2	Multicast address 1st octet (STREAM(2) Ch4) 224 to 239

Parameter name	Comments
H264MLADD2CH4_2	Multicast address 2nd octet (STREAM(2) Ch4) 0 to 255
H264MLADD3CH4_2	Multicast address 3rd octet (STREAM(2) Ch4) 0 to 255
H264MLADD4CH4_2	Multicast address 4th octet (STREAM(2) Ch4) 0 to 255
H264MLADD_2_CH1	STREAM(2) multicast address (ch1)
H264MLADD_2_CH2	STREAM(2) multicast address (ch2)
H264MLADD_2_CH3	STREAM(2) multicast address (ch3)
H264MLADD_2_CH4	STREAM(2) multicast address (ch4)
H264MLPORT_2_CH1	Multicast port(STREAM(2)) (ch1)
H264MLPORT_2_CH2	Multicast port(STREAM(2)) (ch2)
H264MLPORT_2_CH3	Multicast port(STREAM(2)) (ch3)
H264MLPORT_2_CH4	Multicast port(STREAM(2)) (ch4)

2.12.4. Capability information

2.12.4.1. Common definition for all image capture mode

CGI: /cgi-bin/get_capability

Related response:

video_server.image.h264.<Parameter name>=<Value>
 video_server.image.h264-2.<Parameter name>=<Value>
 video_server.image.h264-3.<Parameter name>=<Value>
 video_server.image.h264-4.<Parameter name>=<Value>
 video_server.image.h265.<Parameter name>=<Value>
 video_server.image.h265-2.<Parameter name>=<Value>
 video_server.image.h265-3.<Parameter name>=<Value>
 video_server.image.h265-4.<Parameter name>=<Value>

Parameter name	Value	Comments
resolution	3072x2304,2560x1920, 2048x1536, 1600x1200, 1280x960, 800x600, 640x480, 400x300, 320x240, 3072x1728,2560x1440, 1920x1080, 1280x720, 640x360, 320x180, 2992x2992, 2192x2192, 1280x1280, 640x640,320x320	Supported resolution parameter The value is divided by a comma. e.g.) 1280x960,640x480,320x240
stream_mode	bitrate, framerate, best_effort, vbr	Supported transmission mode bitrate: Constant bitrate framerate: Framerate best_effort: Best effort vbr: VBR e.g.) bitrate,framerate,best_effort,vbr
quality	fine, normal, low	Supported quality parameter e.g.) fine,normal,low
quality_vbr	0,1,2,3,4,5,6,7,8,9	Supported quality parameter for VBR mode
i_interval	0.2, 0.25, 0.33, 0.5, 1, 2, 3, 4, 5	Supported I frame interval (refresh interval) e.g.) 0.2,0.25, 0.33,0.5,1,2,3,4,5
bandwidth	64,128,256,384,512,768,1024, 1536,2048,3072,4096,5120, 6144,7168,8192,9126,10240, 11264,12288,13312,14336, 15360,16384,17408,18432, 19456,20480,21504,22528, 23552,24576	Supported bandwidth parameter e.g.) 64,128,256,384,512,768,1024,1536,2048,3072,4096, 5120,6144,7168,8192,9126,10240,11264,12288,13 312,14336,15360,16384,17408,18432,19456,20480, 21504,22528,23552,24576
framerate	1, 3, 5, 7.5, 10, 12, 15, 20, 30,60	Supported framerate parameter e.g.) 1,3,5,7.5,10,12,15,20,30

2.12.4.2. Definition for each image capture mode

CGI : /cgi-bin/get_capability

Related response:

[Image capture mode definition]

Refer to chapter 2.11.2 (video_server.image.mode) and 2.11.4(video_server.image.mode_fisheye)

[Resolution] (Resolution settings applicable for the current settings for respective imaging mode)

video_server.image.h264.resolution_each_mode.<Image capture mode>=<Value>
video_server.image.h264-2.resolution_each_mode.<Image capture mode>=<Value>
video_server.image.h264-3.resolution_each_mode.<Image capture mode>=<Value>
video_server.image.h264-4.resolution_each_mode.<Image capture mode>=<Value>
video_server.image.h265.resolution_each_mode.<Image capture mode>=<Value>
video_server.image.h265-2.resolution_each_mode.<Image capture mode>=<Value>
video_server.image.h265-3.resolution_each_mode.<Image capture mode>=<Value>
video_server.image.h265-4.resolution_each_mode. <Image capture mode>=<Value>

Refer to chapter 2.12.4.1 for Value 'resolution'.

[Resolution] (All resolution settings applicable for respective capture mode)

video_server.image.h264.resolution_each_mode_all.<Image capture mode>=<Parameter value>
video_server.image.h264-2.resolution_each_mode_all.<Image capture mode>=<Parameter value>
video_server.image.h264-3.resolution_each_mode_all.<Image capture mode>=<Parameter value>
video_server.image.h264-4.resolution_each_mode_all.<Image capture mode>=<Parameter value>
video_server.image.h265.resolution_each_mode_all.<Image capture mode>=<Parameter value>
video_server.image.h265-2.resolution_each_mode_all.<Image capture mode>=<Parameter value>
video_server.image.h265-3.resolution_each_mode_all.<Image capture mode>=<Parameter value>
video_server.image.h265-4.resolution_each_mode_all. <Image capture mode>=<Parameter value>

Refer to 2.12.4.1 for 'Parameter value'

[Maximum frame rate and minimum frame rate]

video_server.image.h264.max_framerate.<Image capture mode>=<Value>
video_server.image.h264.min_framerate.<Image capture mode>=<Value>
video_server.image.h264-2.max_framerate.<Image capture mode>=<Value>
video_server.image.h264-2.min_framerate.<Image capture mode>=<Value>
video_server.image.h264-3.max_framerate.<Image capture mode>=<Value>
video_server.image.h264-3.min_framerate.<Image capture mode>=<Value>
video_server.image.h264-4.max_framerate.<Image capture mode>=<Value>
video_server.image.h264-4.min_framerate.<Image capture mode>=<Value>

video_server.image.h265.max_framerate.<Image capture mode>=<Value>
video_server.image.h265.min_framerate.<Image capture mode>=<Value>
video_server.image.h265-2.max_framerate.<Image capture mode>=<Value>
video_server.image.h265-2.min_framerate.<Image capture mode>=<Value>
video_server.image.h265-3.max_framerate.<Image capture mode>=<Value>
video_server.image.h265-3.min_framerate.<Image capture mode>=<Value>
video_server.image.h265-4.max_framerate.<Image capture mode>=<Value>
video_server.image.h265-4.min_framerate.<Image capture mode>=<Value>

Refer to chapter 2.12.4.1 for Value 'frame rate'.

2.13. Dynamic change of framerate/quality/bitrate/resolution without disconnect the stream

[Important]

When the "Best effort mode" is selected for "Transmission priority" or selected for "Recording stream" to SD memory card, this feature doesn't work. The camera sends response 403 Forbidden.

When CGI parameter includes only "nr_xxx" (that mean one "nr_xxx" or multiple "nr_xxx"), those settings are not saved to memory on camera. This mean that settings will change back when power off and on.

When at least one parameter other than "nr_xxx" exist in CGI (parameters shown on chapter 2.12), those settings are saved.

Ex.

- /cgi-bin/set_h264?nr_framerate=xx -> not save to memory
- /cgi-bin/set_h264?nr_framerate=xx&nr_bandwidth=xx -> not save to memory
- /cgi-bin/set_h264?f_priority=xx&nr_framerate=xx&nr_bandwidth=xx -> save to memory

2.13.1. Stream(1)

[URL] /cgi-bin/set_h264? [<Parameter name>=<Value>][&ch=<Value>]

[Method] POST

[Access level] 1

Parameter name	Value	Comments	Parameter to get current setting (/cgi-bin/getdata)
nr_h264_bandwidth	64, 128, 256, 384, 512, 768, 1024, 1536, 2048, 3072, 4096, 5120, 6144, 7168, 8192, 9216, 10240, 11264, 12288, 13312, 14336, 15360, 16384, 17408, 18432, 19456, 20480, 21504, 22528, 23552, 24576	H.264 /H.265 bandwidth 64: 64kbps, 128: 128 kbps, 256: 256 kbps, 384: 384 kbps, 512: 512 kbps, 768: 768 kbps, 1024: 1024 kbps, 1536: 1536 kbps, 2048: 2048 kbps, 3072: 3072 kbps, 4096: 4096 kbps, 5120: 5120 kbps, 6144: 6144 kbps, 7168: 7168 kbps, 8192: 8192 kbps, 9216: 9216 kbps, 10240: 10240kbps, 11264: 11264kbps, 12288: 12288kbps, 13312: 13312kbps, 14336: 14336kbps, 15360: 15360kbps, 16384: 16384kbps, 17408: 17408kbps, 18432: 18432kbps, 19456: 19456kbps, 20480: 20480kbps, 21504: 21504kbps, 22528: 22528kbps, 23552: 23552kbps, 24576: 24576 kbps	NRH264BWC

Parameter name	Value	Comments	Parameter to get current setting (/cgi-bin/getdata)
nr_framerate	1, 3, 5, 7.5, 10, 12, 15, 20, 30, 60	H.264 /H.265 Framerate 1: 1 fps 3: 3 fps 5: 5 fps 7.5: 7.5 fps 10: 10 fps 12: 12 fps 15: 15 fps 20: 20 fps 30: 30 fps 60: 60 fps	H264NRFRAMERATE
nr_h264_resolution	320 400 640 800 1280 1600 1920 2048 3072 2560 3840 2192 2992	H.264 /H.265 Resolution (4:3) 320: QVGA 400:400x300 640: VGA 800: 800x600 1280: 1280x960 1600: 1600x1200 2048: 2048x1536 2560: 2560x1920 3072: 3072x2304 (16:9) 320: 320x180 640: 640x360 1280: 1280x720 1920: 1920x1080 2560: 2560x1440 3072: 3072x1728 3840: 3840x2160 (1:1) 640 : 640 x 640 320 : 320 x 320 1280 : 1280 x 1280 2192 : 2192 x 2192 2992 : 2992 x 2992	NRH264SIZE
nr_h264_quality	fine, normal, low 0, 1, 2, 3, 4, 5,6, 7, 8, 9	H.264 /H.265 quality setting fine: Fine normal: Normal low: Low 0, 1, 2, 3, 4, 5, 6, 7, 8, 9 : 10 step setting when VBR	NRH264QUAL
ch	1, 2, 3, 4	Channel 1: Channel 1 ,2: Channel 2 3: Channel 3, 4: Channel 4 [Note] #This parameter is supported by Multi-sensor models. When this parameter is omitted, it works as all channel	

[Command example]

Changes H.264 bitrate setting to 4096 kbps

http://192.168.0.10/cgi-bin/set_h264?nr_h264_bandwidth=4096

2.13.2. Stream(2)/Stream(3)/Stream(4)

[Stream 2]

[URL] /cgi-bin/set_h264_2? [<Parameter name>=<Value>][&ch=<Value>]
[Method] POST
[Access level] 1

Parameter name	Value	Parameter to get current setting (/cgi-bin/getdata)
nr_h264_bandwidth	refer to Stream(1)	NRH264BWC_2
nr_framerate	refer to Stream(1)	H264NRFRAMERATE_2
nr_h264_resolution	refer to Stream(1)	NRH264SIZE_2
nr_h264_quality	refer to Stream(1)	NRH264QUAL_2
ch	refer to Stream(1)	-

[Stream 3]

[URL] /cgi-bin/set_h264_3? [<Parameter name>=<Value>][&ch=<Value>]
[Method] POST
[Access level] 1

Parameter name	Value	Parameter to get current setting (/cgi-bin/getdata)
nr_h264_bandwidth	refer to Stream(1)	NRH264BWC_3
nr_framerate	refer to Stream(1)	H264NRFRAMERATE_3
nr_h264_resolution	refer to Stream(1)	NRH264SIZE_3
nr_h264_quality	refer to Stream(1)	NRH264QUAL_3
ch	refer to Stream(1)	-

[Stream 4]

[URL] /cgi-bin/set_h264_4? [<Parameter name>=<Value>][&ch=<Value>]
[Method] POST
[Access level] 1

Parameter name	Value	Parameter to get current setting (/cgi-bin/getdata)
nr_h264_bandwidth	refer to Stream(1)	NRH264BWC_4
nr_framerate	refer to Stream(1)	H264NRFRAMERATE_4
nr_h264_resolution	refer to Stream(1)	NRH264SIZE_4
nr_h264_quality	refer to Stream(1)	NRH264QUAL_4
ch	refer to Stream(1)	-

2.13.3. Capability information

CGI: /cgi-bin/get_capability

Related response:

video_server.image.h264.continuaous_streaming.parameter=<Value>
video_server.image.h264-2.continuaous_streaming.parameter=<Value>
video_server.image.h264-3.continuaous_streaming.parameter=<Value>
video_server.image.h264-4.continuaous_streaming.parameter=<Value>
video_server.image.h265.continuaous_streaming.parameter=<Value>
video_server.image.h265-2.continuaous_streaming.parameter=<Value>
video_server.image.h265-3.continuaous_streaming.parameter=<Value>
video_server.image.h265-4.continuaous_streaming.parameter=<Value>

Parameter name	Value	Comments
parameter	resolution, framerate, bitrate, quality	Supported parameter for changing setting with continuous streaming.

2.14. Dynamic change of I-frame interval without disconnect the stream

[Important]

When using this CGI, I-frame interval setting is not saved to flash memory on camera to prevent frequent access to flash access and shorten lifetime. This mean settings change back when power off and on.

[H.264 stream]

[URL] [/cgi-bin/h264_l_interval?interval=<Value>\[&stream=<Value>\]\[&ch=<Value>\]](#)

[Method] GET

[Access level] 3

Parameter name	Value	Comments
interval	0.2, 0.25, 0.33,0.5, 1, 2,3, 4, 5	I-frame insertion interval 0.2 : 0.2 sec, 0.25 :0.25 sec, 0.33 : 0.33 sec, 0.5 : 0.5 sec , 1: 1 sec, 2: 2 sec ,3: 3 sec, 4: 4 sec, 5: 5 sec
stream	1, 2,3, 4	Specify the H.264 stream 1 :Stream 1, 2 :Stream 2, 3 :Stream 3, 4 :Stream 4 # This parameter can be omitted.(Default: 1)
ch	1, 2, 3, 4	Channel 1: Channel 1, 2: Channel 2,3: Channel 3, 4: Channel 4 #This parameter is supported by Multi-sensor models.

[Command example]

Set I-frame interval as 1 second

http://192.168.0.10/cgi-bin/h264_l_interval?interval=1

[H.265 stream]

[URL] [/cgi-bin/h265_l_interval?interval=<Value>\[&<stream>=<Value>\]\[&ch=<Value>\]](#)

[Method]: GET

[Access level] 3

Parameter name	Value	Comments
interval	0.2, 0.25, 0.33,0.5, 1, 2,3, 4, 5	I-frame insertion interval
stream	1, 2,3, 4	Specify the H.265 stream
ch	1, 2, 3, 4	Channel #This parameter is supported by Multi-sensor models.

[Command example]

Set I-frame interval as 1 second

http://192.168.0.10/cgi-bin/h265_l_interval?interval=1

2.15. H.264 profile/ encoding entropy setup

2.15.1. H.264 profile/ encoding entropy setup

[URL] /cgi-bin/setdata? [<Parameter name>=<Value>]

[Method] POST

[Access level] 1

Parameter name	Value	Comments	Parameter to get current setting (/cgi-bin/getdata)
H264PROFILE	0, 1	0: High profile 1: Baseline profile	/cgi-bin/getdata? req= H264PROFILE
H264PROFILE_2	0, 1	0: High profile 1: Baseline profile	/cgi-bin/getdata? req= H264PROFILE_2
H264PROFILE_3	0, 1	0: High profile 1: Baseline profile	/cgi-bin/getdata? req= H264PROFILE_3
H264PROFILE_4	0, 1	0: High profile 1: Baseline profile	/cgi-bin/getdata? req= H264PROFILE_4
H264CODING	0, 1	H.264(1) encoding entropy 0: CABAC (Default) 1: CAVLC	H264ENCTYPE
H264CODING_2	0, 1	H.264(2) encoding entropy	H264ENCTYPE_2
H264CODING_3	0, 1	H.264(3) encoding entropy	H264ENCTYPE_3
H264CODING_4	0, 1	H.264(4) encoding entropy	H264ENCTYPE_4

e.g.) Set H.264(1) to CAVLC

<http://192.168.0.10/cgi-bin/setdata?H264CODING=1>

2.15.2. Capability information

Parameter name	Value	Comments
format	jpeg, mjpeg, h264, h264_cabac , h265	Supported image format jpeg : Jpeg 1 shot mjpeg : Motion jpeg h264: H.264(CAVLC) h264_cabac : H.264(CABAC) h265: H.265

2.16. JPEG setup

2.16.1. JPEG setup

[URL] /cgi-bin/setdata?[<Parameter name>=<Value>]

[Method] GET/POST

[Access level] 1

Parameter name	Value	Comments	Parameter to get current setting (/cgi-bin/getdata)
LIVESIZE	320,640, 1280,2048 800,1600 2560,1920, 2192,2992	JPEG(1) resolution Resolution to be set (4:3) 320 : QVGA 640 : VGA 1280 : 1280 x 960 2048 : 2048 x 1536 800 800 x 600 1600: 1600x1200 2560: 2560x1920 Resolution to be set (16:9) 320 : 320 x 180 640 : 640 x 360 1280 : 1280 x 720 1920 : 1920 x 1080 2048 : 1920 x 1080 2560: 2560x1440 Resolution to be set (1:1) 320 : 320 x 320 640 : 640 x 640 1280 : 1280 x 1280 2192 : 2192 x 2192 2992 : 2992 x 2992	LIVESIZE
LIVEQUAL1280	0, 1, 2, 3, 4, 5, 6, 7, 8, 9	JPEG(1) quality 0 :means superfine, 1 :means fine, 2, 3, 4, 5 :means normal, 6, 7, 8, 9 :means low	LIVEQUAL
LIVESIZE2	2048, 1920, 1600, 1280, 640,400, 320,	JPEG(2) resolution	LIVESIZE2
LIVEQUAL640	0, 1, 2, 3, 4, 5, 6, 7, 8, 9	JPEG(2) quality	LIVEQUAL2
LIVESIZE3	2048, 1920, 1600, 1280, 640,400, 320,	JPEG(3) resolution	LIVESIZE3
LIVEQUAL320	0, 1, 2, 3, 4, 5, 6, 7, 8, 9	JPEG(3) quality	LIVEQUAL3

e.g.) Set each JPEG as the following.

JPEG(1):1920x1080, quality:5, JPEG(2):1280x720, quality:2, JPEG(3):640x480, quality:9

<http://192.168.0.10/cgi-bin/setdata?LIVESIZE=1920&LIVEQUAL1280=5&LIVESIZE2=1280&LIVEQUAL640=2&LIVESIZE3=640&LIVEQUAL320=9>

2.16.2. Capability information

2.16.2.1. Common definition for all image capture mode

CGI: /cgi-bin/get_capability

[Resolution, quality for JPEG snapshot]

video_server.image.jpeg.<Parameter name>=<Value>

Parameter name	Value	Comments
resolution	3072x2304 2560x1920, 2048x1536, 1600x1200, 1280x960, 800x600, 640x480, 400x300, 320x240, 3072x1728 2560x1440, 1920x1080, 1280x720, 640x360, 320x180, 2992x2992 , 2192x2192, 1280x1280, 640x640, 320x320	Supported resolution parameter of jpeg The value is divided by a comma. e.g.) 640x480,320x240
quality	0,1,2,3,4,5,6,7,8,9	Supported quality parameter of jpeg e.g.) 0,1,2,3,4,5,6,7,8,9

[Resolution, quality, frame rate for MJPEG]

video_server.image.mjpeg.<Parameter name>=<Value>

Parameter name	Value	Comments
resolution	refer to JPEG snapshot	
quality	refer to JPEG snapshot	
framerate	0.1, 0.2, 0.33, 0.5, 1, 2, 3, 5, 6, 10, 15, 30	Supported framerate parameter of mjpeg The value is divided by a comma. e.g.) 0.1,0.2,0.33,0.5,1,2,3,5,6,10,15,30

[The maximum file size of a jpeg file]

video_server.image.jpeg.max_size.<Parameter name>=<Value>

Parameter name	Value	Comments
2048x1536	(numerical value)	<p>The maximum file size of a jpeg file when the resolution of the image is '2048x1536'.</p> <p>The value is divided by a comma. Structure: <Value1>,<Value2>,<Value3>,<Value4>,<Value5>, ,,, ,<Value(n)>, ,,</p> <p>When the selectable 'quality parameter for JPEG' of the camera are '0 / 1 / 2 / 3 / 4 / 5 / 6 / 7 / 8 / 9 / 10', the value means below.</p> <p><Value1>: This is the maximum file size of a jpeg file, when the quality parameter setting is '0'. <Value2>: This is the maximum file size of a jpeg file, when the quality parameter setting is '1'. <Value3>: This is the maximum file size of a jpeg file, when the quality parameter setting is '2'. <Value4>: This is the maximum file size of a jpeg file, when the quality parameter setting is '3'. <Value5>: This is the maximum file size of a jpeg file, when the quality parameter setting is '4'. <Value6>: This is the maximum file size of a jpeg file, when the quality parameter setting is '5'. <Value7>: This is the maximum file size of a jpeg file, when the quality parameter setting is '6'. <Value8>: This is the maximum file size of a jpeg file, when the quality parameter setting is '7'. <Value9>: This is the maximum file size of a jpeg file, when the quality parameter setting is '8'. <Value10>: This is the maximum file size of a jpeg file, when the quality parameter setting is '9'.</p> <p>e.g.) 138,103,86,70,60,52,43,35,30,26</p>
1920x1080	(numerical value)	The maximum file size of a jpeg file when the resolution of the image is '1920x1080'.
1600x1200	(numerical value)	The maximum file size of a jpeg file when the resolution of the image is '1600x1200'.
1280x960	(numerical value)	The maximum file size of a jpeg file when the resolution of the image is '1280x960'.
1280x720	(numerical value)	The maximum file size of a jpeg file when the resolution of the image is '1280x720'.
800x600	(numerical value)	The maximum file size of a jpeg file when the resolution of the image is '800x600'.
640x480	(numerical value)	The maximum file size of a jpeg file when the resolution of the image is '640x480'.
640x360	(numerical value)	The maximum file size of a jpeg file when the resolution of the image is '640x360'.
400x300	(numerical value)	The maximum file size of a jpeg file when the resolution of the image is '400x300'.
320x240	(numerical value)	The maximum file size of a jpeg file when the resolution of the image is '320x240'.
320x180	(numerical value)	The maximum file size of a jpeg file when the resolution of the image is '320x180'.

Parameter name	Value	Comments
2560x1920	(numerical value)	The maximum file size of a jpeg file when the resolution of the image is '2560x1920'.
2560x1440	(numerical value)	The maximum file size of a jpeg file when the resolution of the image is '2560x1440'.
320x320	(numerical value)	The maximum file size of a jpeg file when the resolution of the image is '320x320'.
640x640	(numerical value)	The maximum file size of a jpeg file when the resolution of the image is '640x640'.
1280x1280	(numerical value)	The maximum file size of a jpeg file when the resolution of the image is '1280x1280'.
2192x2192	(numerical value)	The maximum file size of a jpeg file when the resolution of the image is '2192x2192'.
2992x2992	(numerical value)	The maximum file size of a jpeg file when the resolution of the image is '2992x2992'.
3072x2304	(numerical value)	The maximum file size of a jpeg file when the resolution of the image is '3072x2304'.
3072x1728	(numerical value)	The maximum file size of a jpeg file when the resolution of the image is '3072x1728'.

2.16.2.2. Definition for each image capture mode

CGI: /cgi-bin/get_capability

Related response:

[Image capture mode definition]

Refer to chapter 2.11.2 (video_server.image.mode) and 2.11.4 (video_server.image.mode_fisheye)

[Resolution] (Available resolution for current settings)

video_server.image.jpeg.resolution_each_mode.<Image capture mode>=<Value>

video_server.image.mjpeg.resolution_each_mode.<Image capture mode>=<Value>

Refer to chapter 2.16.2.12.12.4.1 for Value 'resolution'.

[Resolution] (Selectable resolution for each mode)

video_server.image.jpeg.resolution_each_mode_all.<Image capture mode>=<Value>

video_server.image.mjpeg.resolution_each_mode_all.<Image capture mode>=<Value>

Refer to chapter 2.16.2.1 for Value 'resolution'.

[Maximum frame rate]

video_server.image.mjpeg.max_framerate.<Image capture mode>=<Value>

Refer to 2.16.2.1 for Value 'frame rate'.

3. Smart Coding (GOP control/ Smart facial coding/ Auto VIQS)

3.1. Overview

• **GOP control:** Reduce data when there is little motion in the image.

Off: Normal encode.

On(Low): I frame interval will automatically change 1sec to 8sec.

On(Mid): I frame interval will automatically change 1sec to 16sec

On(Advanced): I frame interval is fixed to 60sec.

On(Frame rate control): The frame rate ranges from 1fps to setting value(ex.30fps) depending on the size of image changes

• **Smart facial coding/Auto VIQS**

Maintains high image quality in the areas of the image containing people's faces and moving objects, and reduces the transmission data volume in other areas of the image.

Off: Does not use "AUTO VIQS" and "Smart Facial Coding".

On(AUTO VIQS): Maintains high image quality in the areas of the image containing moving objects, and reduces the transmission data volume in other areas of the image.

On(Smart Facial Coding): Maintains high image quality in the areas of the image containing people's faces and moving objects, and reduces the transmission data volume in other areas of the image.

3.2. Smart Coding setup

[URL] /cgi-bin/setdata[?<Parameter name>=<Value>]

[Method] GET/POST

[Access level] 1

Parameter name	Value	Comments	Parameter to get current setting (/cgi-bin/getdata)
SMARTCODING	0, 1, 2, 4, 5	GOP control setting for stream(1) 0: OFF 1: ON(Low) 2: ON(Mid) 4: ON(Advanced) 5: On(Frame rate control):	SMARTCODING
SMARTCODING_2	0, 1, 2, 4, 5	GOP control setting for stream(2)	SMARTCODING_2
SMARTCODING_3	0, 1, 2, 4, 5	GOP control setting for stream(3)	SMARTCODING_3
SMARTCODING_4	0, 1, 2, 4, 5	GOP control setting for stream(4)	SMARTCODING_4
SMART_FACE	0,1	" Smart Facial Coding " setting for stream(1) 0: Off, 1:On	SMART_FACE
SMART_VIQS	0,1	" Auto VIQS " for stream(1) 0: Off, 1:On	SMART_VIQS
SMART_VIQS_2	0,1	" Auto VIQS " for stream(2)	SMART_VIQS_2
The following parameters can be used for Multi-sensor models			
SMARTCODING_CH1	0, 1, 2, 4, 5	GOP control for stream(1) /CH1	SMARTCODING_CH1
SMARTCODING_CH2	0, 1, 2, 4, 5	GOP control for stream(1) /CH2	SMARTCODING_CH2
SMARTCODING_CH3	0, 1, 2, 4, 5	GOP control for stream(1) /CH3	SMARTCODING_CH3
SMARTCODING_CH4	0, 1, 2, 4, 5	GOP control for stream(1) /CH4	SMARTCODING_CH4
SMARTCODING_2_CH1	0, 1, 2, 4, 5	GOP control for stream(2) /CH1	SMARTCODING_2_CH1
SMARTCODING_2_CH2	0, 1, 2, 4, 5	GOP control for stream(2) /CH2	SMARTCODING_2_CH2
SMARTCODING_2_CH3	0, 1, 2, 4, 5	GOP control for stream(2) /CH3	SMARTCODING_2_CH3
SMARTCODING_2_CH4	0, 1, 2, 4, 5	GOP control for stream(2) /CH4	SMARTCODING_2_CH4
SMART_VIQS_CH1	0,1	" Auto VIQS " for stream(1) /CH1 0: Off, 1:On	SMART_VIQS_CH1
SMART_VIQS_CH2	0,1	" Auto VIQS " for stream(1) /CH2	SMART_VIQS_CH2
SMART_VIQS_CH3	0,1	" Auto VIQS " for stream(1) /CH3	SMART_VIQS_CH3
SMART_VIQS_CH4	0,1	" Auto VIQS " for stream(1) /CH4	SMART_VIQS_CH4
SMART_VIQS_2_CH1	0,1	" Auto VIQS " for stream(2) /CH1	SMART_VIQS_2_CH1
SMART_VIQS_2_CH2	0,1	" Auto VIQS " for stream(2) /CH2	SMART_VIQS_2_CH2
SMART_VIQS_2_CH3	0,1	" Auto VIQS " for stream(2) /CH3	SMART_VIQS_2_CH3
SMART_VIQS_2_CH4	0,1	" Auto VIQS " for stream(2) /CH4	SMART_VIQS_2_CH4

e.g.) Set stream(1) to Smart Coding mode ON(Mid)

<http://192.168.0.10/cgi-bin/setdata?SMARTCODING=2>

3.3. Capability information

CGI: /cgi-bin/get_capability

Related response:

[Overview]

video_server.smartcoding.<Parameter name>=<Value>

Parameter name	Value	Comments
supported stream	yes, no h264-1,h264-2,h264-3, h264-4,h265-1,h265-2, h265-3,h265-4	Smart Coding mode is supported or not supported Supported stream
type	gop, smartface, autoviqs	Supported smartcoding type gop: GOP control function. smartface: 'Smart facial coding' and 'Auto VIQS' . autoviqs: 'Auto VIQS'. #Not 'autoviqs' but 'smart face' exist for model that support both 'Smart facial coding' and 'Auto VIQS'.

[GOP control for each stream]

video_server.smartcoding.h265-1.gop.<Parameter name>=<Value>

video_server.smartcoding.h265-2.gop.<Parameter name>=<Value>

video_server.smartcoding.h265-3.gop.<Parameter name>=<Value>

video_server.smartcoding.h265-4.gop.<Parameter name>=<Value>

video_server.smartcoding.h264-1.gop.<Parameter name>=<Value>

video_server.smartcoding.h264-2.gop.<Parameter name>=<Value>

video_server.smartcoding.h264-3.gop.<Parameter name>=<Value>

video_server.smartcoding.h264-4.gop.<Parameter name>=<Value>

Parameter name	Value	Comments
supported	yes, no	GOP control is supported or not supported
parameter	low, mid, advanced, dynamic_fps	Supported parameter of the gop control low: ON(Low) mid: ON(Mid) advanced: ON(Advanced) dynamic_fps: On(Frame rate control):

[Smart facial coding and Auto VIQS for each stream]

video_server.smartcoding.h265-1.smartface.<Parameter name>=<Value>
 video_server.smartcoding.h265-2.smartface.<Parameter name>=<Value>
 video_server.smartcoding.h265-3.smartface.<Parameter name>=<Value>
 video_server.smartcoding.h265-4.smartface.<Parameter name>=<Value>
 video_server.smartcoding.h264-1.smartface.<Parameter name>=<Value>
 video_server.smartcoding.h264-2.smartface.<Parameter name>=<Value>
 video_server.smartcoding.h264-3.smartface.<Parameter name>=<Value>
 video_server.smartcoding.h264-4.smartface.<Parameter name>=<Value>

Parameter name	Value	Comments
supported	yes, no	'Smart facial coding' and 'Auto VIQS' are supported or not supported

[Auto VIQS for each stream]

video_server.smartcoding.h265-1.autoviqs.<Parameter name>=<Value>
 video_server.smartcoding.h265-2.autoviqs.<Parameter name>=<Value>
 video_server.smartcoding.h265-3.autoviqs.<Parameter name>=<Value>
 video_server.smartcoding.h265-4.autoviqs.<Parameter name>=<Value>
 video_server.smartcoding.h264-1.autoviqs.<Parameter name>=<Value>
 video_server.smartcoding.h264-2.autoviqs.<Parameter name>=<Value>
 video_server.smartcoding.h264-3.autoviqs.<Parameter name>=<Value>
 video_server.smartcoding.h264-4.autoviqs.<Parameter name>=<Value>

Parameter name	Value	Comments
supported	yes, no	'Smart facial coding' and 'Auto VIQS' are supported or not supported

4. Audio Streaming

4.1. Supported Protocol and audio codec

[Audio input(from camera to PC)]

G.726/G.711/AAC-LC with H.264 / H.265

- RTP(CGI control) unicast
- RTP(CGI control) multicast
- RTP(RTSP control) unicast
- RTP(RTSP control) multicast
- RTP over RTSP
- RTP over RTSP over HTTP

G.726/G.711/AAC-LC with MJPEG

- HTTP (CGI control)

[Audio output (from PC to camera)]

G.726 with H.264 / H.265

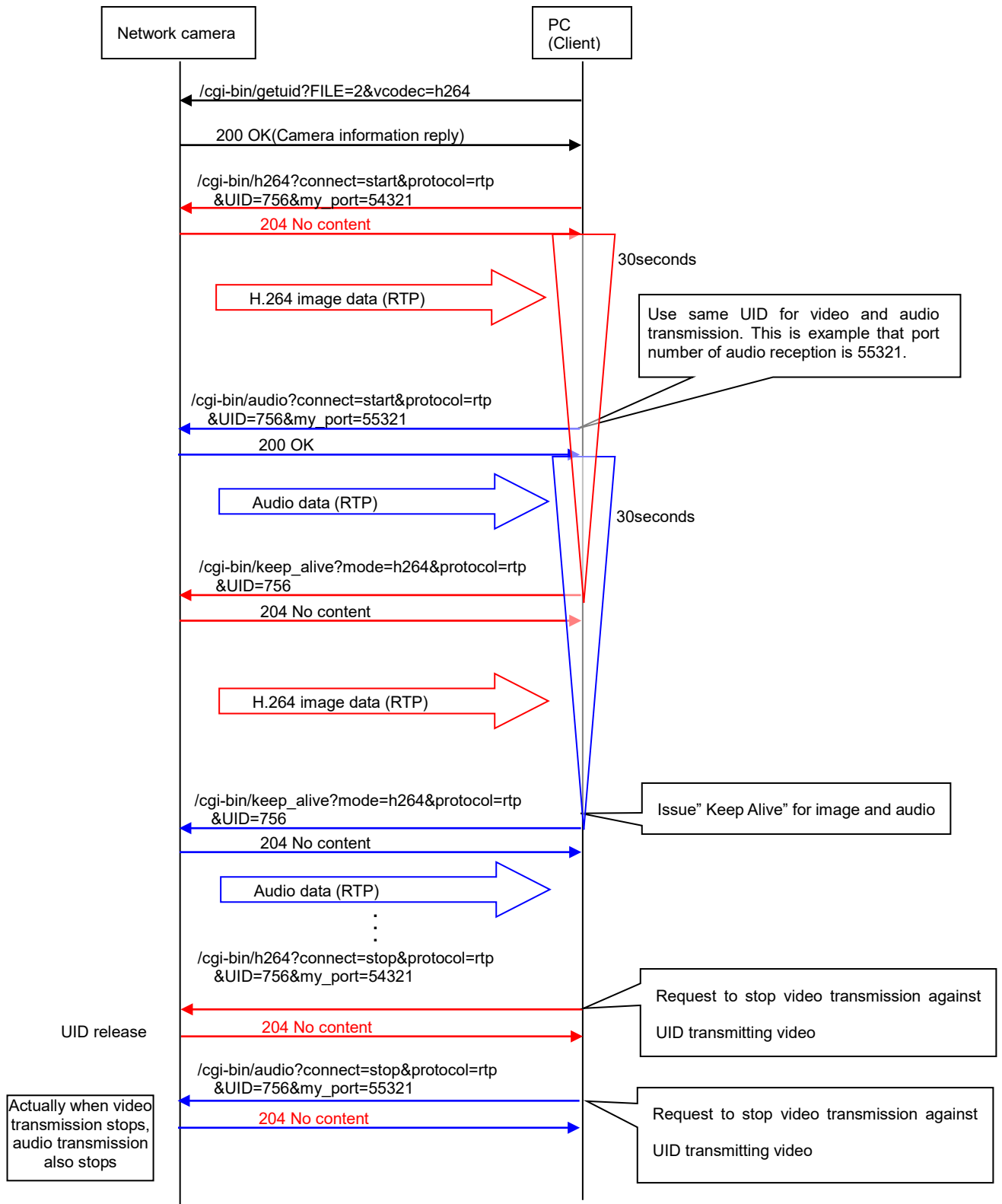
- RTP(CGI control)

G.726 with MJPEG

- HTTP (CGI control)

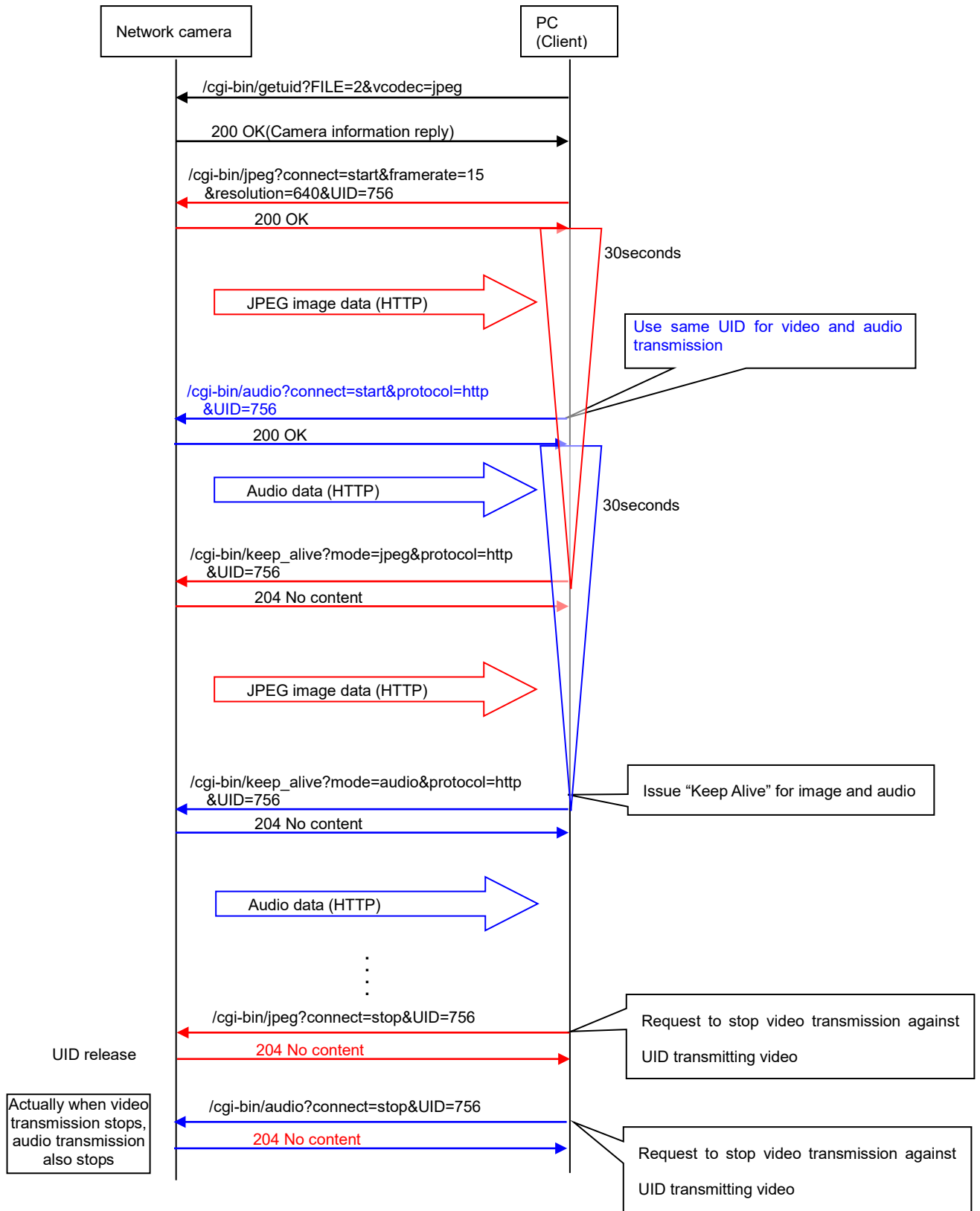
4.2. Audio input transmission (CGI control)

4.2.1. Sequence of H.264/H.265 and Audio input transmission



*If a video transmission stops, an audio transmission of same UID also stops

4.2.2. Sequence of MJPEG and Audio input transmission



4.2.3. Get UID

Please refer to chapter 2.2.3

4.2.4. Audio input transmission

[URL]

/cgi-bin/audio?connect=<Value>&protocol=<Value>[&my_port=<Value>]&mode=in&UID=<Value>[&stream=<Value>][&ch=<Value>]

[Method] GET

[Access level] 3

Parameter name	Value	Comments
connect	start stop	Transmit audio start : start audio transmission stop : stop audio transmission (for user ID which has already started stream transmission)
protocol	rtp http	rtp : audio transmission in case of H.264/H.265 http : audio transmission in case of JPEG
my_port	numerical value	Receive port no. of audio (Even number only) #It is possible to omit in case of H.264/H.265 multicast and JPEG transmission.
mode	in out	in: audio input out: audio output
UID	numerical value	User ID(acquired UID)
stream	1, 2 3, 4	Specify the stream 1, stream 2, stream 3 or stream 4. 1 :Stream 1 ,2 :Stream 2 3 :Stream 3 ,4 :Stream 4 Default: 1
ch	1, 2, 3, 4	Channel 1: Channel 1 ,2: Channel 2 3: Channel 3 ,4: Channel 4 #This parameter is supported by Multi-sensor models or Quad stream mode of Fisheye models.

[Command example]

Audio transmission start (in case of port no. 38004 and user ID is 263)

http://192.168.0.10/cgi-bin/audio?my_port=38004&connect=start&protocol=rtp&UID=263&mode=in

Stream 2

http://192.168.0.10/cgi-bin/audio?my_port=38004&connect=start&protocol=rtp&UID=263&mode=in&stream=2

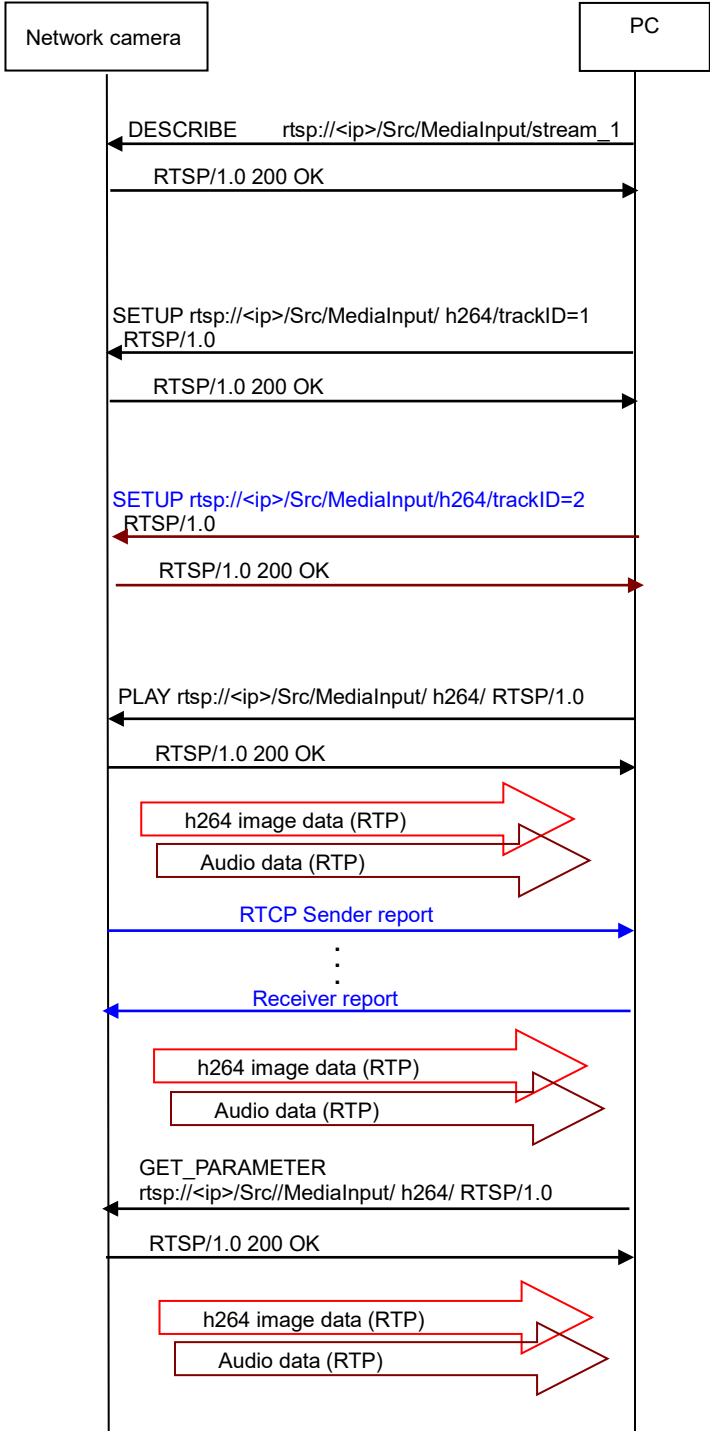
4.2.5. Keep Alive

Please refer to chapter 2.2.7

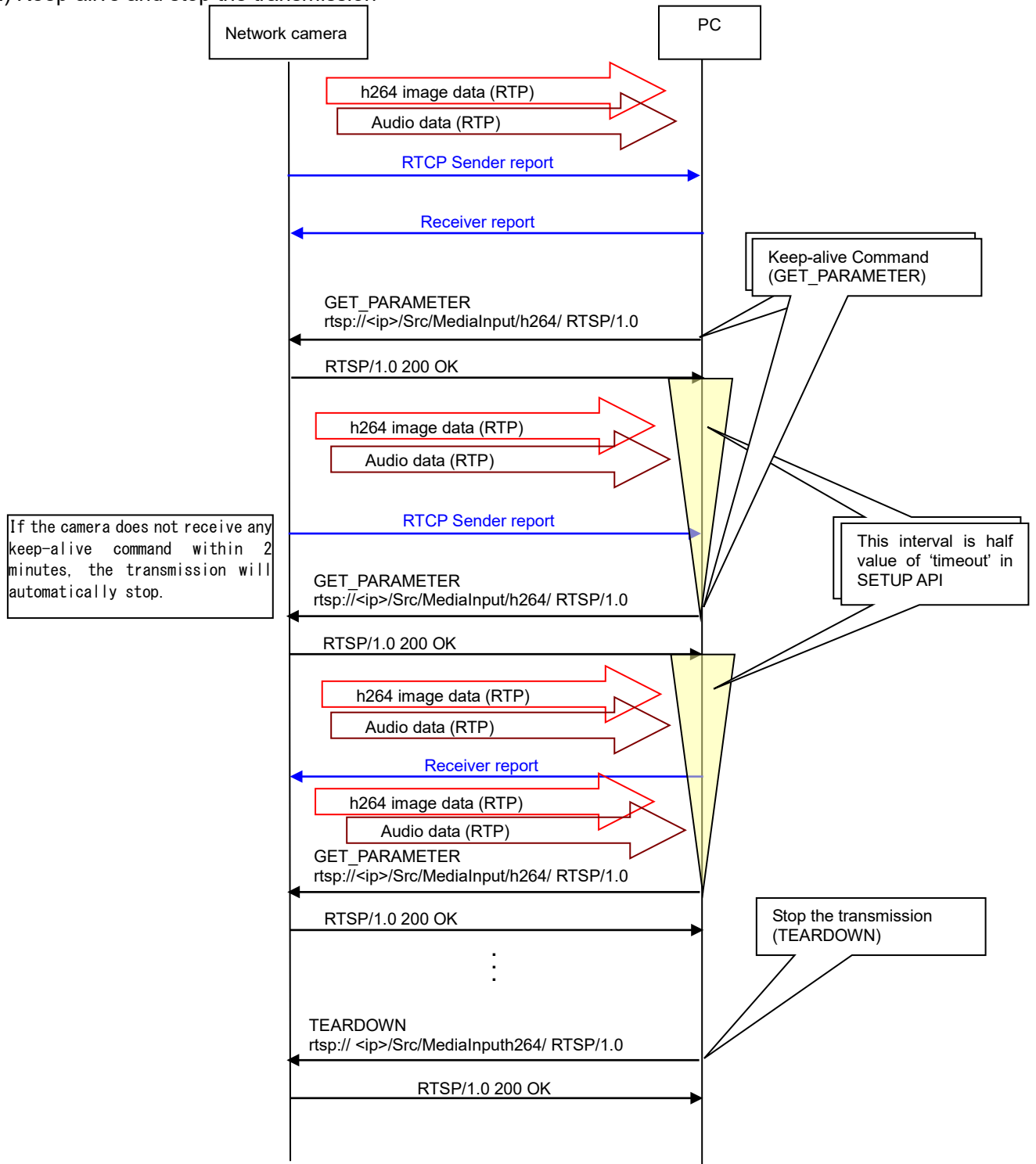
4.3. Audio input transmission (RTSP control)

4.3.1. Sequence of H.264/H.265 and Audio input transmission

(1) Start the transmission



(2) Keep-alive and stop the transmission



4.3.2. RTSP URL

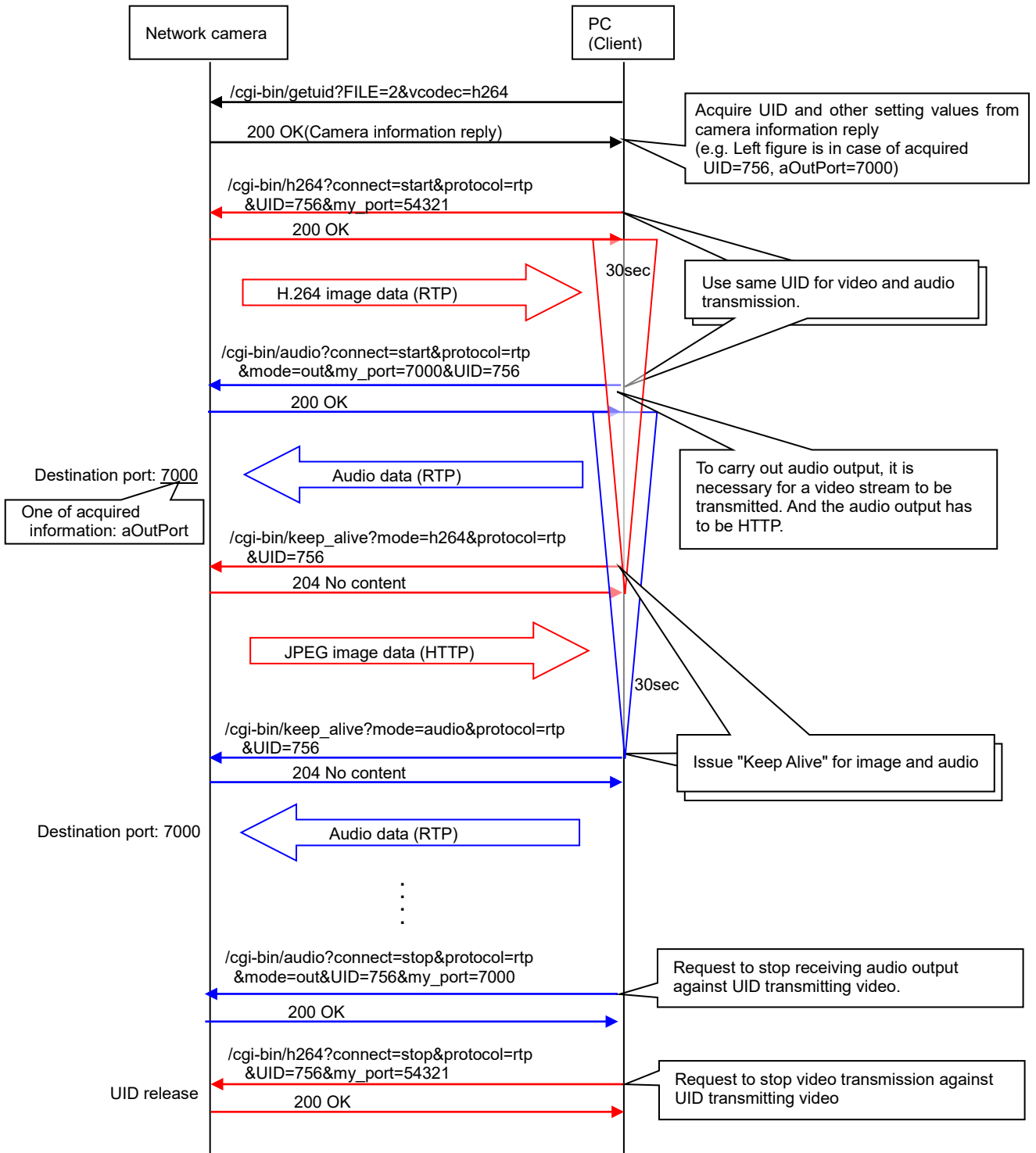
Refer to 2.3.1

4.3.3. Command description

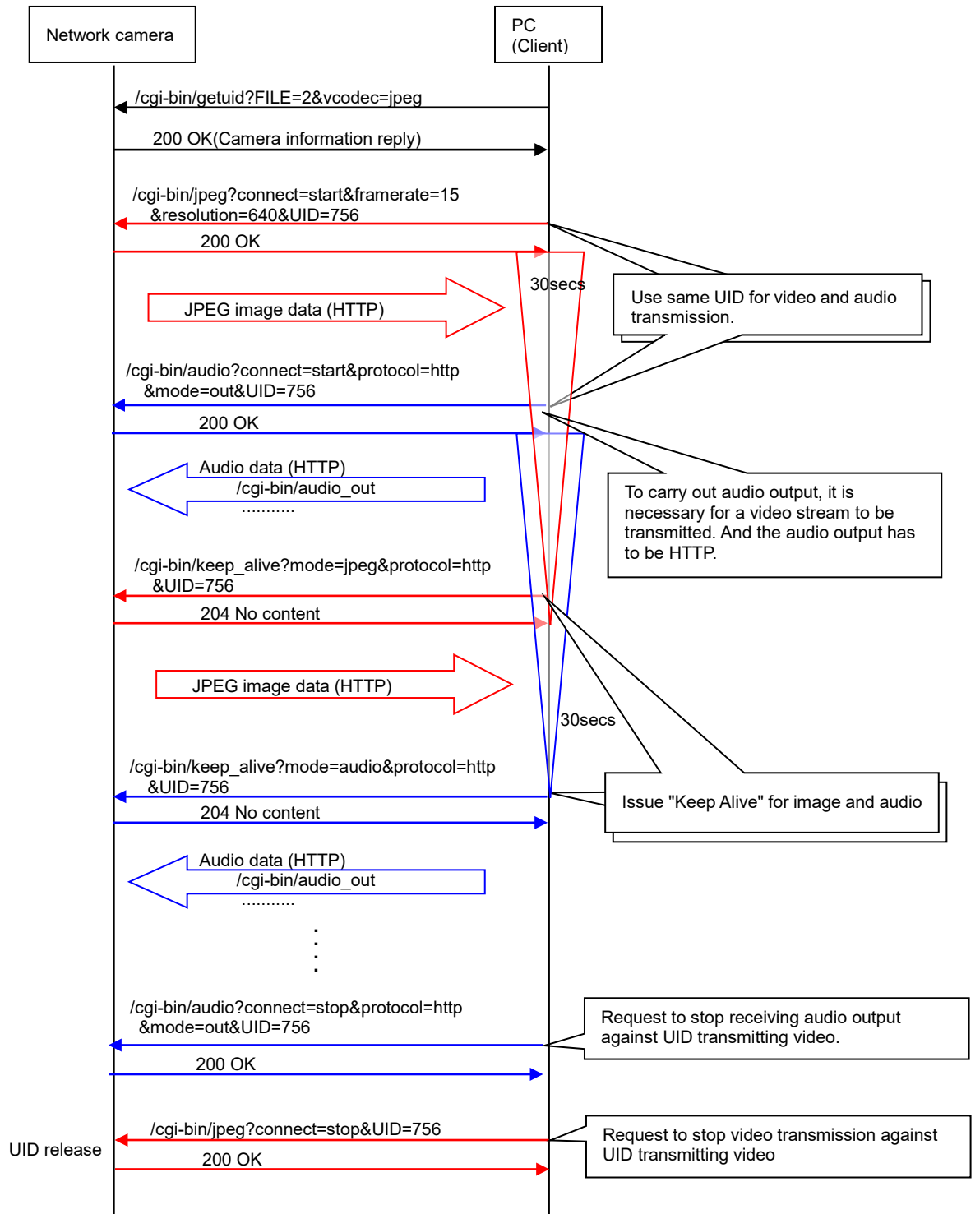
Refer to 2.3.2

4.4. Audio output (CGI control)

4.4.1. Sequence of H.264/H.265 and Audio output



4.4.2. Sequence of MJPEG and Audio output



4.4.3. Get UID

Please refer to chapter 2.2.3

4.4.4. Keep alive

Please refer to chapter 2.2.7

4.4.5. Get audio out status

CGI: `/cgi-bin/getdata`

Parameter name	Value	Comments
AUDIOSTATUS	on, off	Audio output status (PC to Camera)

4.5. Audio setup

[URL] /cgi-bin/set_audio? [<Parameter name>=<Value>]

[Method] POST

[Access level] 1

Parameter name	Value	Comments	Parameter to get current setting (/cgi-bin/getdata)
audio	off, in, out, inout, inout_full,	Audio mode setup off :OFF in :Mic input out :Audio output inout :Interactive (half duplex) inout_full: Interactive (full duplex)	AUDIO
audio_encoder	g726, g711 aac	Audio encoder setup g726 : G.726 g711 : G.711 (u-law) aac : AAC-LC [Note] G. 711 is available only when "audio" is selected for 'in'.	AUDIOENC 0: G.726 1 : G.711 (u-law) 2 : AAC-LC
audio_sens	low, middle, high, line_low, line_middle, line_high	Audio input volume (Camera to PC) low :low (MIC) middle :middle (MIC) high :high (MIC) line_low :low (Line) line_middle: middle (Line) line_high :high (Line)	AUDIOSENS
out_sens	low, middle, high	Audio output volume (PC to Camera) low :Low middle :Middle high :High	AUDIOOUTSENS
audio_bitrate	16, 32 64,96,128	Audio bit rate 16 :16 kbps (G.726) 32 :32 kbps (G.726) 64 :64 kbps (AAC-LC) 96 :96 kbps (AAC-LC) 128:128kbps (AAC-LC)	(G.726) AUDIOBITRATE (AAC-LC) AUDIOBITRATE_AAC
audio_interval	20, 40, 80, 160	Mic input interval (Camera to PC) 20 :20msec, 40 :40 msec 80 :80msec, 160 :160 msec	AUDIOINT
out_port	1024 to 50000	Audio output port (PC to Camera)	AUDIOOUTPORT
out_interval	160, 320, 640, 1280	Audio output interval (PC to Camera) 160 :160 msec, 320 :320 msec 640 :640 msec, 1280 :1 280 msec	AUDIOOUTINT
mic_select	internal, external	Mic select internal: The camera's built-in mic is used. external: Uses the audio inputted from the mic or the line input terminal.	AUDIOMIC

[Command examples]

Change Audio Settings to Mic input

http://192.168.0.10/cgi-bin/set_audio?audio=in

4.6. Capability information

[Audio mode]

video_server.audio.<Parameter name>=<Value>

Parameter name	Value	Comments
transmission	off, input, output, half_duplex, full_duplex	Audio mode setup off :OFF in :Mic input out :Audio output inout :Interactive (half duplex) inout_full: Interactive (full duplex)

[Input]

video_server.audio.audio_input.<Parameter name>=<Value>

Parameter name	Value	Comments
number	(numerical value)	The number of audio (Mic) input
type	internal, external	internal: The camera has the built-in mic. external: The external mic or line input can be connected to the camera as audio input
encode_type	g726_16k, g726_32k, g711_64k, aac-lc_64k aac-lc_96k aac-lc_128k	Supported audio input encoding format g726_16k: G.726(16kbps) g726_32k: G.726(32kbps) g711_64k: G.711(64kbps) aac-lc_64k: AAC-LC(64kbps) aac-lc_96k: AAC-LC(96kbps) aac-lc_128k: AAC-LC(128kbps)

[Output]

video_server.audio.audio_output.<Parameter name>=<Value>

Parameter name	Value	Comments
number	(numerical value)	The number of audio output (speaker)
encode_type	g726_16k, g726_32k,	Supported audio output encoding format g726_16k: G.726(16kbps) g726_32k: G.726(32kbps)

5. Image

5.1. Image rotation

5.1.1. Image rotation setup

[URL] /cgi-bin/set_basic?img_rotate=<Value>

[Method] GET/POST

[Access level] 1

Parameter name	Value	Comments	Parameter to get current setting (/cgi-bin/getdata)
img_rotate	0, 90, 180, 270	Image rotation 0: Normal, 90: 90 degree, 180: 180 degree (Upside-down), 270: 270 degree	IMAGE_ROTATION

e.g.) Set 90 degree

http://192.168.0.10/cgi-bin/set_basic?img_rotate=90

5.1.2. Capability information

CGI: /cgi-bin/get_capability

Related response:

[Overview]

video_server.image.rotation.<Parameter name>=<Value>

Parameter name	Value	Comments
supported	yes, no	Image rotation function supported or not supported
parameter	0,90,180,270	Supported parameter. 0: Off, 90: 90 deg. 180: Upside down, 270: 270deg.

5.2. Upside down setup

[Fixed camera models]

[URL] [/cgi-bin/set_basic?upside=1](#)

[Method] GET/POST

[Access level] 1

Parameter name	Value	Comments	Parameter to get current setting (/cgi-bin/getdata)
upside	0, 1	Upside-down 1: ON (desktop) 0: OFF (ceiling) #When using this parameter for Multi-sensor models, it effects to all ch.	UPSIDEDOWN
The following parameters can be used for Multi-sensor models			
upside1	0, 1	Upside-down of ch1	UPSIDEDOWN
upside2	0, 1	Upside-down of ch2	UPSIDEDOWN_CH2
upside3	0, 1	Upside-down of ch3	UPSIDEDOWN_CH3
upside4	0, 1	Upside-down of ch4	UPSIDEDOWN_CH4

[Command example]

http://192.168.0.10/cgi-bin/set_basic?upside=1

[PTZ camera models]

[URL] [/cgi-bin/set_camfunc?upside=1](#)

[Method] POST

[Access level] 1

Parameter name	Value	Comments	Parameter to get current setting (/cgi-bin/getdata)
upside	0, 1	Upside-down 1: OFF (ceiling) 0: ON (desktop)	UPSIDEDOWN

5.3. Brightness

5.3.1. Brightness control

[URL] /cgi-bin/camctrl?[<Parameter name>=<Value>]

[Method] GET

[Access level] 2

Parameter name	Value	Comments	Parameter to get current setting (/cgi-bin/getdata)
bright	1, up, down	1 : return to default up : make bright down : make dark	BRIGHTNESS
ch	1, 2, 3, 4	Channel 1: Channel 1 2: Channel 2 3: Channel 3 4: Channel 4 #This parameter is supported by Multi-sensor models. When this parameter is omitted, it works as a channel 1	-

[Command example]

Brightness

<http://192.168.0.10/cgi-bin/camctrl?bright=up>

*Model: X8570, S8530 (Request to a channel 2)

<http://192.168.0.10/cgi-bin/camctrl?bright=up&ch=2>

5.3.2. Brightness status display setup

[URL] /cgi-bin/set_basic?bright_disp=<Value>

[Method] POST

[Access level] 1

Parameter name	Value	Comments	Parameter to get current setting (/cgi-bin/getdata)
bright_disp	0, 1	Brightness status display on image 0: OFF, 1: ON	BRIGHTNESSDISP

[Command example]

Configure the brightness status display setting to OFF

http://192.168.0.10/cgi-bin/set_basic?bright_disp=0

5.3.3. Capability information

CGI: /cgi-bin/get_capability

[Supported models reply]

video_server.cam_ctrl.brightness=camctrl_bright

5.4. B/W Switch

5.4.1. B/W Switch control

[URL] /cgi-bin/camctrl?black_white=<Value>[&ch=<Value>]

[Method] GET

[Access level] 2

Parameter name	Value	Comments	Parameter to get current setting (/cgi-bin/getdata)
black_white	off , on , on_ir auto1, auto2, auto3,	off : B/W switch OFF on : B/W switch ON (IR Light Off) on_ir : B/W switch ON(IR Light On) auto1 : B/W switch AUTO1(IR Light Off) auto2 : B/W switch AUTO2(IR Light On) auto3 : B/W switch AUTO3	BW
ch	1, 2, 3, 4	Channel 1: Channel 1 2: Channel 2 3: Channel 3 4: Channel 4 [Note] #This parameter is supported by Multi-sensor models. When this parameter is omitted, it works as a channel 1	-

[Command examples]

B/W switch AUTO1

http://192.168.0.10/cgi-bin/camctrl?black_white=auto1

*Model: X8570, S8530 (Request to a channel 2)

http://192.168.0.10/cgi-bin/camctrl?black_white=on&ch=2

5.4.2. Capability information

CGI: /cgi-bin/get_capability

video_server.cam_ctrl.bw.<Parameter name>=<Value>

Parameter name	Value	Comments
supported	yes, no	B/W switch command supported or not supported
type	IR, simple	B/W switch type IR: IR filter simple: Simple B/W switch (support off and auto1)

5.5. Image quality setup

5.5.1. Capability information

CGI: /cgi-bin/get_capability

Related response:

[Overview]

video_server.image.sensor.<Parameter name>=<Value>

Parameter name	Value	Comments
sd	yes, no	SuperDynamic / Wide dynamic range function supported or not supported
fog	yes, no	Fog compensation is supported or not supported
hlc	yes, no	High light compensation is supported or not supported
auto_adjust	yes, no	Intelligent auto function is supported or not
aspect_ratio	4_3, 16_9	Aspect ratio of the image sensor 4_3 : 4:3 sensor 16_9: 16:9 sensor

[Parameter and level of SuperDynamic / Wide dynamic range]

video_server.image.sensor.sd.<Parameter name>=<Value>

Parameter name	Value	Comments
parameter	0, 1	Supported value of Super dynamic
level_range	<Minimum value>, <Maximum value>	Supported parameter range of the Super dynamic level e.g.) '.sd.level_range=0,31' means 0 to 31 can be set.

5.5.2. Intelligent auto setup

[URL] /cgi-bin/image_adjust? [<Parameter name>=<Value>]
 [Method] POST
 [Access level] 1

Parameter name	Value	Comments	Parameter to get current setting (/cgi-bin/getdata)
auto_adjust	0, 1	Intelligent auto 0: Off 1: On	AUTO_ADJUST
face_priority_level	0-255, reset	Face priority level	FACE_PRIORITY_LEVEL
motion_priority_level	0-255, reset	Motion priority level	MOTION_PRIORITY_LEVEL
Ch	1, 2, 3, 4	Channel 1: Channel 1 2: Channel 2 3: Channel 3 4: Channel 4 [Note] #This parameter is supported by Multi-sensor models. When this parameter is omitted, it works as all channel	-

5.5.3. Super Dynamic / Wide dynamic range

[URL] /cgi-bin/image_adjust? [<Parameter name>=<Value>]
 [Method] POST
 [Access level] 1

Parameter name	Value	Comments	Parameter to get current setting (/cgi-bin/getdata)
Sd	0, 1,	Super Dynamic / Wide dynamic range 0 :OFF 1 :ON [Note] - This setting is available only when "Outdoor scene" or "Indoor scene" is selected for "Light control mode" setting.	MEGASD
sd_level	0-31, reset	Super dynamic level	SD_LEVEL
bic	0, 1	Backlight compensation 0 :OFF, 1 :ON #When "On" is selected for "Super Dynamic / Wide dynamic range / Intelligent auto", or "High light compensation", this setting is unavailable.	BLC
bic_level	0 to 31, reset	Level of back light compensation 0 to 31: Level reset: Reset to default value	BLC_LEVEL
hlc	0, 1	High light compensation 0: OFF , 1: ON #When "On" is selected for "Super Dynamic / Wide dynamic range / Intelligent auto " or "Backlight compensation", this setting is unavailable.	HLC
hlc_level	0 to 31, reset	Level of high light compensation 0 to 31: Level reset: Reset to default value	HLCLEVEL
Ch	1, 2, 3, 4	Channel 1: Channel 1 2: Channel 2 3: Channel 3 4: Channel 4 #This parameter is supported by Multi-sensor models. When this parameter is omitted, it works as all channel	-

[Command examples]
 Super Dynamic ON

http://192.168.0.10/cgi-bin/image_adjust?sd=1

5.5.4. Light control mode setup

[URL] /cgi-bin/image_adjust? [<Parameter name>=<Value>]
 [Method] POST
 [Access level] 1

Parameter name	Value	Comments	Parameter to get current setting (/cgi-bin/getdata)
alc_elc	shutter, flickeress, flickeress_60, elc, alc	Light control mode shutter : Outdoor scene flickeress: Indoor scene / Indoor scene(50Hz) flickeress_60: Indoor scene (60Hz) elc : ELC alc : Fix shutter #When "On" is selected for "Super Dynamic / Wide dynamic range", "ELC" and "Fix shutter" are unavailable.	ALCELC
brightness	0 to 255 reset	Brightness 0 to 255 :The level reset :Reset the setting to the default	BRIGHTNESS
agc	0 to 31 reset	AGC 0 to 31 :The level reset :Reset the setting to the default	AGC
shutter	1_30, 3_100, 3_120, 2_100, 2_120, 1_100, 1_120, 1_250, 1_500, 1_1000, 1_2000, 1_4000, 1_8000, 1_10000 off, auto, flickerless,	Fix shutter speed / ELC(Maximum exposure time) for Light control mode 1_30 :1/30 Fix/ ELC(1/30s) 3_100: 3/100 Fix/ ELC(3/100s) 3_120: 3/120 Fix/ ELC(3/120s) 2_100: 2/100 Fix/ ELC(2/100s) 2_120: 2/120 Fix/ ELC(2/120s) 1_100: 1/100 Fix/ ELC(1/100s) 1_120: 1/120 Fix/ ELC(1/120s) 1_250: 1/250 Fix/ ELC(1/250s) 1_500: 1/500 Fix/ ELC(1/500s) 1_1000 :1/1000 Fix/ELC(1/1000s) 1_2000 :1/2000 Fix/ELC(1/2000s) 1_4000 :1/4000 Fix/ELC(1/4000s) 1_8000 :1/8000 Fix/ELC(/8000s) 1_10000 :1/10000 Fix/ELC(1/10000s) off :OFF(Fixed at 1/60 seconds) auto :AUTO flickerless :1/100 (Fixed at 1/100 seconds) [Note] When setting this parameter, the "Light control mode" would be changed to "alc" automatically.	SHUTTER

Parameter name	Value	Comments	Parameter to get current setting (/cgi-bin/getdata)
slowshutter	16_30, 0.5333, 10_30, 1_3, 6_30, 1_5, 4_30, 1_7.5, 2_30, 1_15, 1_30, 3_120, 2_100, 2_120, 1_100, 1_120, 1_250, 1_500, 1_1000, 1_2000, 1_4000, 1_10000	Auto slow shutter(Sensitivity up) 16_30, 0.5333: Max. 16/30s 10_30, 1_3 : Max. 10/30s 6_30, 1_5 : Max. 6/30s 4_30, 1_7.5 : Max. 4/30s 2_30, 1_15: Max. 2/30s 1_30, off : Max. 1/30s 3_120: Max.3/120s 2_100: Max.2/100s 2_120: Max.2/120s 1_100: Max.1/100s 1_120: Max.1/120s 1_250: Max.1/250s 1_500: Max.1/500s 1_1000: Max.1/1000s 1_2000: Max.1/2000s 1_4000: Max.1/4000s	SENSITIVITY 16_30: Max. 16/30s 10_30 : Max. 10/30s 6_30 : Max. 6/30s 4_30 : Max. 4/30s 2_30: Max. 2/30s 1_30 : Max. 1/30s 3_120: Max.3/120s 2_100: Max.2/100s 2_120: Max.2/120s 1_100: Max.1/100s 1_120: Max.1/120s 1_250: Max.1/250s 1_500: Max.1/500s 1_1000: Max.1/1000s 1_2000: Max.1/2000s 1_4000: Max.1/4000s
Ch	1, 2, 3, 4	Channel 1: Channel 1 2: Channel 2 3: Channel 3 4: Channel 4 [Note] #This parameter is supported by Multi-sensor models. When this parameter is omitted, it works as all channel	-

[Command examples]

Change the gain of Image

http://192.168.0.10/cgi-bin/image_adjust?agc=20

Set the speed of electric shutter to 1/10000 seconds.

http://192.168.0.10/cgi-bin/image_adjust?shutter=1_10000

5.5.5. Day & Night(IR) setup

[URL] [/cgi-bin/image_adjust? \[<Parameter name>=<Value>\]](#)
 [Method] POST
 [Access level] 1

Parameter name	Value	Comments	Parameter to get current setting (/cgi-bin/getdata)
black_white	on, on_ir, off, auto1, auto2, auto3	Day & Night on :The black & white mode (IR Light Off) on_ir: The black & white mode (IR Light On) off:The color mode. auto1: auto(IR Light Off) auto2: auto (IR Light On) auto3: Super Chroma Compensation(SCC)	BW
black_white_level	high, low	The threshold illuminance level (brightness) to switch between the color mode and the black & white mode. High/ Low	BWLEVEL
black_white_time	2, 10, 30, 60	Dwell time The interval before switching between the color mode and black & white mode from the following 2 : 2 sec 10 : 10sec 30 : 30sec 60 : 1min	BWTIME
ir_led_sync	AutoH, AutoM, AutoL, Off	IR LED light intensity Off: IR LED light does not light. AutoH: High AutoM: Middle AutoL: Low	IRLED
ir_led_intensity	0, 1	Intensity control 0: Off 1: On	IRLEDCTRL
Ch	1, 2, 3, 4	Channel 1: Channel 1, 2: Channel 2 3: Channel 3, 4: Channel 4 #This parameter is supported by Multi-sensor models. When this parameter is omitted, it works as all channel.	-

[Command examples]

Set the Day/Night mode to auto2

http://192.168.0.10/cgi-bin/image_adjust?black_white=auto2

Set the IR LED Light mode to AutoM

http://192.168.0.10/cgi-bin/image_adjust?ir_led_sync=AutoM

5.5.6. White balance setup

[URL] [/cgi-bin/image_adjust? \[<Parameter name>=<Value>\]](#)
 [Method] POST
 [Access level] 1

Parameter name	Value	Comments	Parameter to get current setting (/cgi-bin/getdata)
whitebalance	awc, atw1, atw2 auto, hold	White balance awc :Automatic white balance control mode(AWC) atw1 :Automatic tracing white balance mode.(ATW1) atw2 :Automatic tracing white balance mode under a sodium lamp.(ATW2) auto :AUTO hold :HOLD [Important] When "AWC" is selected, send one more cgi to adjust the white balance (/cgi-bin/image_adjust?awc_set=on).	WHITEBAL
rvol	0 to 255, reset	Red gain 0 to 255 :volume reset :Reset the color to the default	RVOL
bvol	0 to 255, reset	Blue gain 0 to 255 :volume reset :Reset the color to the default	BVOL
Ch	1, 2, 3, 4	Channel 1: Channel 1 2: Channel 2 3: Channel 3 4: Channel 4 [Note] #This parameter is supported by Multi-sensor models. When this parameter is omitted, it works as all channel	-

5.5.7. Detailed setup

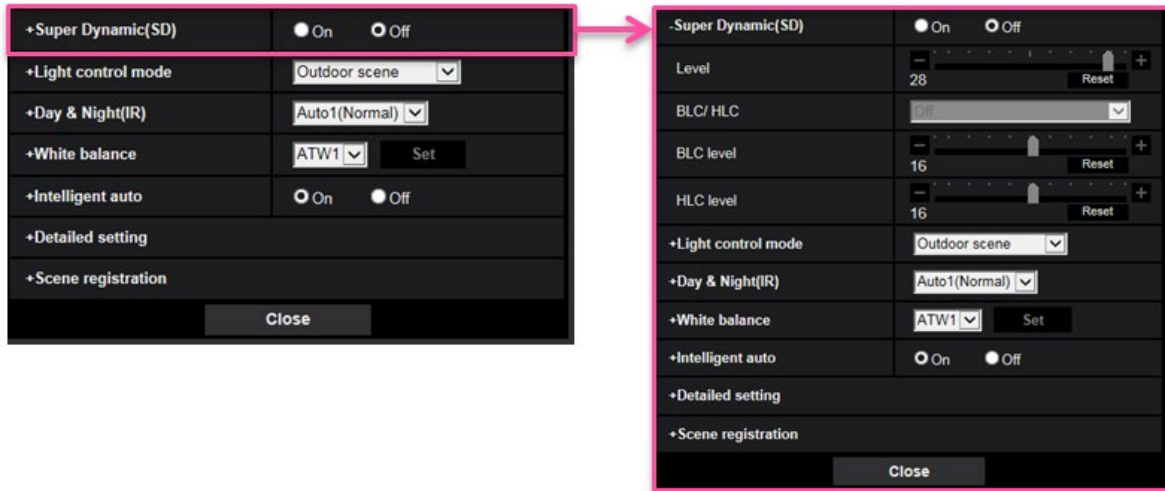
[URL] /cgi-bin/image_adjust? [<Parameter name>=<Value>]
 [Method] POST
 [Access level] 1

Parameter name	Value	Comments	Parameter to get current setting (/cgi-bin/getdata)
contrast_auto	0, 1	Auto contrast adjust 0: Off , 1: On #When "On" is selected for "auto_adjust", this setting is unavailable.	CONTRAST_AUTO
contrast_level	0-255, reset	Contrast level	CONTRAST_LEVEL
dark_revise_level	0-255, reset	Adaptive black stretch	DARK_REVISE_LEVEL
highlight_revise_level	0-255, reset	Adaptive highlight stretch	HIGHLIGHT_REVISE_LEVEL
fog_revise	0, 1	Fog compensation 0: OFF, 1: ON #When "On" is selected for "auto_adjust " or "contrast_auto", this setting is unavailable.	FOG
fog_revise_level	0 to 8, reset	Level of fog compensation	FOGLEVEL
chroma	0 to 255,reset	Chroma gain level	CHROMA
hue	0-255, reset	Hue level	HUE
sharpness	0 to 31,reset,	Aperture level(Sharpness)	APERTURE
pedestal	0 to 255,reset	Pedestal level	PEDESTAL
dnr	0 to 255,reset	Digital noise reduction	DNR
Ch	1, 2, 3, 4	Channel 1: Channel 1, 2: Channel 2 3: Channel 3, 4: Channel 4 #This parameter is supported by Multi-sensor models. When this parameter is omitted, it works as all channel	-

5.5.8. URL of the image adjust setup page

[URL] /cgi-bin/image_adjust
 [Method] GET
 [Access level] 1

When calling the URL, the 'image adjust setup (html page)' will appear (The camera reply the html file). It can change settings inside of the html.



5.5.9. Switching image quality tuning data (Detailed setting which cannot be configured by setup menu or other CGI)

[URL] /cgi-bin/image_profile?[<Parameter name>=<Value>]
 [Method] POST
 [Access level] 1

Parameter Name	Value	Comments
type	0, 1	0: Image quality tuning data which is in the current firmware is applied. 1: Image quality tuning data which is used before V4.25 is applied.

[Note]:

As for the cameras which do not support this command, image quality tuning data which is in the current firmware is always used.

5.6. VIQS (manual area setup)

[URL] /cgi-bin/set_viqs?[<Parameter name>=<Value>]

[Method] GET

[Access level] 1

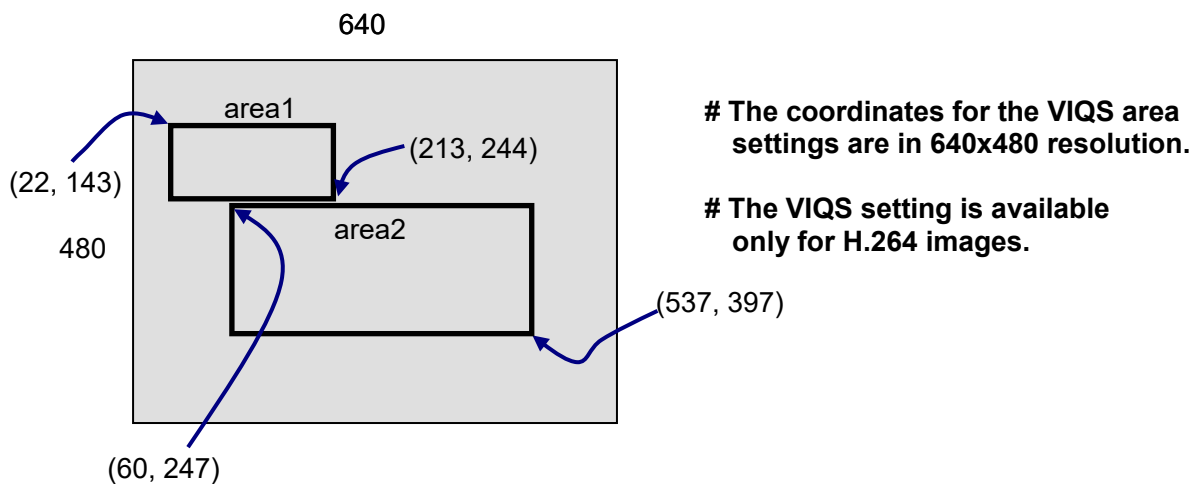
Parameter name	Value	Comments	Parameter to get current setting (/cgi-bin/getdata)
stream1	0, 1	Whether or not to activate VIQS function to stream 1. 0: Off, 1: On	VIQSSTREAM1
stream2	0, 1	Whether or not to activate VIQS function to stream 2.	VIQSSTREAM2
stream3	0, 1	Whether or not to activate VIQS function to stream 3.	VIQSSTREAM3
stream4	0, 1	Whether or not to activate VIQS function to stream 4.	VIQSSTREAM4
area_ulx	0 to 639	Upper left X coordinates of VIQS area1	VIQSULX
area_uly	0 to 479	Upper left Y coordinates of VIQS area1	VIQSULY
area_brx	0 to 639	Lower right X coordinates of VIQS area1	VIQSBRX
area_bry	0 to 479	Lower right Y coordinates of VIQS area1	VIQSBRY
area_state	enable , disable	Status of area 1 enable : Use area 1 disable : Not use area 1	-
area2_ulx	0 to 639	Upper left X coordinates of VIQS area2	VIQSULX2
area2_uly	0 to 479	Upper left Y coordinates of VIQS area2	VIQSULY2
area2_brx	0 to 639	Lower right X coordinates of VIQS area2	VIQSBRX2
area2_bry	0 to 479	Lower right Y coordinates of VIQS area2	VIQSBRY2
area2_state	enable , disable	Status of area 2	-
area3_ulx	0 to 639	Upper left X coordinates of VIQS area3	VIQSULX3
area3_uly	0 to 479	Upper left Y coordinates of VIQS area3	VIQSULY3
area3_brx	0 to 639	Lower right X coordinates of VIQS area3	VIQSBRX3
area3_bry	0 to 479	Lower right Y coordinates of VIQS area3	VIQSBRY3
area3_state	enable , disable	Status of area 3	-
area4_ulx	0 to 639	Upper left X coordinates of VIQS area4	VIQSULX4
area4_uly	0 to 479	Upper left Y coordinates of VIQS area4	VIQSULY4
area4_brx	0 to 639	Lower right X coordinates of VIQS area4	VIQSBRX4
area4_bry	0 to 479	Lower right Y coordinates of VIQS area4	VIQSBRY4
area4_state	enable , disable	Status of area 4	-
area5_ulx	0 to 639	Upper left X coordinates of VIQS area5	VIQSULX5
area5_uly	0 to 479	Upper left Y coordinates of VIQS area5	VIQSULY5
area5_brx	0 to 639	Lower right X coordinates of VIQS area5	VIQSBRX5
area5_bry	0 to 479	Lower right Y coordinates of VIQS area5	VIQSBRY5
area5_state	enable , disable	Status of area 5	-
area6_ulx	0 to 639	Upper left X coordinates of VIQS area6	VIQSULX6
area6_uly	0 to 479	Upper left Y coordinates of VIQS area6	VIQSULY6
area6_brx	0 to 639	Lower right X coordinates of VIQS area6	VIQSBRX6
area6_bry	0 to 479	Lower right Y coordinates of VIQS area6	VIQSBRY6
area6_state	enable , disable	Status of area 6	-
area7_ulx	0 to 639	Upper left X coordinates of VIQS area7	VIQSULX7
area7_uly	0 to 479	Upper left Y coordinates of VIQS area7	VIQSULY7
area7_brx	0 to 639	Lower right X coordinates of VIQS area7	VIQSBRX7
area7_bry	0 to 479	Lower right Y coordinates of VIQS area7	VIQSBRY7

area7_state	enable , disable	Status of area 7	-
area8_ulx	0 to 639	Upper left X coordinates of VIQS area8	VIQSULX8
area8_uly	0 to 479	Upper left Y coordinates of VIQS area8	VIQSULY8
area8_brx	0 to 639	Lower right X coordinates of VIQS area8	VIQSBRX8
area8_bry	0 to 479	Lower right Y coordinates of VIQS area8	VIQSBRY8
area8_state	enable , disable	Status of area 8	-
viqs_level	0 to 9	Level: 0(min) to 9 (max) *Configure the difference level in the image quality between specified areas and non-specified areas. The greater the difference level, the more the image quality of the non-specified area is reduced. This makes it possible to moderate the image data size.	-
reply	info	It will replay account of how much % of selected VIQS area has in the whole images. *It is optional. When you select off, it will not replay.	-
reg	on off	After restarting, select whether VIQS area information is saved or not in the memory on: area information is saved after restarting (Default) off: area information is not saved after restarting *It is optional. When you select 'off', area information will not be saved when you restart system. *If you change area frequently, please set to 'off' in order not to save area information.	-
preno	0 , 1 to 8	Preset position number to configure the area. 0: Without the preset positions *1 1-8: Preset positions *This parameter is supported by the PTZ cameras which have preset position feature.	-
ch	1, 2, 3, 4	Channel 1: Channel 1 2: Channel 2 3: Channel 3 4: Channel 4 *This parameter is supported by Multi-sensor models. When this parameter is omitted, it effects to all ch.	-

[Command example]

Stream1: On, VIQS area 1: (22, 143)-(213, 244), VIQS area 2: (60, 247)-(537,397)

http://192.168.0.10/cgi-bin/set_viqs?stream1=1&stream2=0&area_ulx=22&area_uly=143&area_brx=213&area_bry=244&area2_ulx=60&area2_uly=247&area2_brx=537&area2_bry=397&reply=info



Response format, when the 'reply' parameter sets to 'info'.

HTTP/1.1 200OK[0d][0a]

...

[0d][0a]

VIQS area / total area = ** %[0d][0a]

*Recommended: Less than 40% of total area.[0d][0a]

The best percentage of the VIQS area / total area are 40%.

5.7. Lens distortion compensation

[URL] /cgi-bin/dist_comp?comp=<Value>

[Method] GET

[Access level] 1

Parameter name	Value	Comments	Parameter to get current setting (/cgi-bin/getdata)
comp	0 to 255	Lens distortion compensation 0 to 255	DISTCOMP

[Command example]

Set Lens distortion compensation: 20

http://192.168.0.10/cgi-bin/dist_comp?comp=20

5.8. Privacy zone setup

5.8.1. Privacy zone setup (Fixed (Box / Dome) camera / 360-degree camera / Multi-sensor camera)

[URL] /cgi-bin/privacymode?[<Parameter name>=<Value>]

[Method] POST

[Access level] 1

Parameter name	Value	Comments	Parameter to get current setting (/cgi-bin/getdata)
area1_ulx	0 to 639	Upper left X coordinates of zone 1	PRVULX1
area1_uly	0 to 479	Upper left Y coordinates of zone 1	PRVULY1
area1_brx	0 to 639	Lower right X coordinates of zone 1	PRVBRX1
area1_bry	0 to 479	Lower right Y coordinates of zone 1	PRVBRY1
area2_ulx	0 to 639	Upper left X coordinates of zone 2	PRVULX2
area2_uly	0 to 479	Upper left Y coordinates of zone 2	PRVULY2,
area2_brx	0 to 639	Lower right X coordinates of zone 2	PRVBRX2
area2_bry	0 to 479	Lower right Y coordinates of zone 2	PRVBRY2
area3_ulx	0 to 639	Upper left X coordinates of zone 3	PRVULX3
area3_uly	0 to 479	Upper left Y coordinates of zone 3	PRVULY3
area3_brx	0 to 639	Lower right X coordinates of zone 3	PRVBRX3
area3_bry	0 to 479	Lower right Y coordinates of zone 3	PRVBRY3
area4_ulx	0 to 639	Upper left X coordinates of zone 4	PRVULX4
area4_uly	0 to 479	Upper left Y coordinates of zone 4	PRVULY4
area4_brx	0 to 639	Lower right X coordinates of zone 4	PRVBRX4
area4_bry	0 to 479	Lower right Y coordinates of zone 4	PRVBRY4
area5_ulx	0 to 639	Upper left X coordinates of zone 5	PRVULX5
area5_uly	0 to 479	Upper left Y coordinates of zone 5	PRVULY5
area5_brx	0 to 639	Lower right X coordinates of zone 5	PRVBRX5
area5_bry	0 to 479	Lower right Y coordinates of zone 5	PRVBRY5
area6_ulx	0 to 639	Upper left X coordinates of zone 6	PRVULX6
area6_uly	0 to 479	Upper left Y coordinates of zone 6	PRVULY6
area6_brx	0 to 639	Lower right X coordinates of zone 6	PRVBRX6
area6_bry	0 to 479	Lower right Y coordinates of zone 6	PRVBRY6
area7_ulx	0 to 639	Upper left X coordinates of zone 7	PRVULX7
area7_uly	0 to 479	Upper left Y coordinates of zone 7	PRVULY7
area7_brx	0 to 639	Lower right X coordinates of zone 7	PRVBRX7
area7_bry	0 to 479	Lower right Y coordinates of zone 7	PRVBRY7
area8_ulx	0 to 639	Upper left X coordinates of zone 8	PRVULX8
area8_uly	0 to 479	Upper left Y coordinates of zone 8	PRVULY8
area8_brx	0 to 639	Lower right X coordinates of zone 8	PRVBRX8
area8_bry	0 to 479	Lower right Y coordinates of zone 8	PRVBRY8

Parameter name	Value	Comments	Parameter to get current setting (/cgi-bin/getdata)
display_mode	mask, mosaic	Display type of privacy zone mask: Gray mosaic: Mosaic #This parameter is supported by some fixed camera models	-
ch	1, 2, 3, 4	Channel 1: Channel 1,2: Channel 2 3: Channel 3,4: Channel 4 #This parameter is supported by Multi-sensor models.	-
zone1_display	mask, off	Select On/Off for each zone mask: on off: off	
zone2_display	mask, off	Select On/Off for each zone mask: on off: off	
zone3_display	mask, off	Select On/Off for each zone mask: on off: off	
zone4_display	mask, off	Select On/Off for each zone mask: on off: off	
zone5_display	mask, off	Select On/Off for each zone mask: on off: off	
zone6_display	mask, off	Select On/Off for each zone mask: on off: off	
zone7_display	mask, off	Select On/Off for each zone mask: on off: off	
zone8_display	mask, off	Select On/Off for each zone mask: on off: off	

[Command example]

Set privacy zone 1 (Upper left coordinates: (142,210), Lower right coordinates: (244,292),
Display type: Mosaic (S25xx Series)

http://192.168.0.10/cgi-bin/privacymode?area1_ulx=142&area1_uly=210&area1_brx=244&area1_bry=292&display_mode=mosaic&zone1_display=mask

[Get registration status for all area]

CGI: /cgi-bin/getdata

Related response

Parameter name	Value	Comments
PRVENT	Bit string	Registration information of privacy zone 1: Registered zone 0: Not registered zone e.g.) 11000000: Zone1,2 are registered zone and Zone 3,4,5,6,7,8 are not registered zone.

5.8.2. Privacy zone setup (PTZ camera)

[URL] /cgi-bin/set_ptz_privacy? [<Parameter name>=<Value>]

[Method] POST

[Access level] 1

Parameter name	Value	Comments	Parameter to get current setting (/cgi-bin/getdata)
zoneset	1 to 32	Privacy zone number to be set	-
area_ulx	0 to 639	Upper left X coordinates of zone 1	
area_uly	0 to 479	Upper left Y coordinates of zone 1	
area_brx	0 to 639	Lower right X coordinates of zone 1	
area_bry	0 to 479	Lower right Y coordinates of zone 1	
zonedel	1 to 32	Privacy zone number to be deleted	-

[Command example]

Set privacy zone 1 (Upper left coordinates: (142,210), Lower right coordinates: (244,292))
(X65xx Series)

http://192.168.0.10/cgi-bin/set_ptz_privacy?zoneset=1&area_ulx=142&area_uly=210&area_brx=244&area_bry=292

Delete privacy zone 1

http://192.168.0.10/cgi-bin/set_ptz_privacy?zonedel=1

The number of privacy zone can be switched 8 or 32. See Chapter [6.13](#).

6. PTZ

6.1. Capability information

CGI: /cgi-bin/get_capability

Related response:

[Overview]

[video_server.cam_ctrl.ptz.<Parameter name>=<Value>](#)

Parameter name	Value	Comments
supported	yes, no	PTZ function supported or not supported
zoom	(numerical value)	Zoom ratio
el_zoom	(numerical value)	EL-zoom maximum ratio
command	camctrl, direct_16, direct_256d, direct_256r, click_centering, drag_zoom, default_zoom	Supported ptz command camctrl: /cgi-bin/camctrl direct_16: /cgi-bin/directctrl (16steps) >>> Chapter 6.2.1 direct_256d: /cgi-bin/directctrl (256steps) >>> Chapter 6.2.1 direct_256r: /cgi-bin/directctrl (256steps) >>> Chapter 6.2.2 click_centering: Click & centering >>> Chapter 6.12 drag_zoom: Drag & Zoom command >>> Chapter 6.11 default_zoom: Zoom reset command

[Pan range]

[video_server.cam_ctrl.ptz.pan_range.<Parameter name>=<Value>](#)

Parameter name	Value	Comments
----------------	-------	----------

Parameter name	Value	Comments
type	endless, limited	Endless or not endless of pan endless: Endless pan limited : Not endless
abs_value	(numerical value),(numerical value)	Pan range of the absolute angle control command (/cgi-bin/absctrl). (Chapter 6.9) The value is divided by comma. e.g.) -475,475 means pan range is -475 to 475

[Tilt range]

[video_server.cam_ctrl.ptz.tilt_range.<Parameter name>=<Value>](#)

Parameter name	Value	Comments
abs_value	(numerical value),(numerical value)	Tilt range of the absolute angle control command (/cgi-bin/absctrl) (Chapter 6.9) The value is divided by comma. e.g.) -150,1850 means tilt range is -150 to 1850(-15.0 to 185.0)

[Zoom ratio for Motorized varifocal lens]

[video_server.cam_ctrl.ptz.<Parameter name>=<Value>](#)

Parameter name	Value	Comments
v_zoom	(numerical value)	Maximum zoom ratio by Motorized varifocal lens >>>Chapter6.3
v_zoom_current	(numerical value)	Current zoom ration by Motorized varifocal lens

[Auto back focus]

[video_server.cam_ctrl.abf.<Parameter name>=<Value>](#)

Parameter name	Value	Comments
supported	yes, no	ABF command supported or not supported >>>Chapter 6.3.3

[Focus]

[video_server.cam_ctrl.focus.<Parameter name>=<Value>](#)

Parameter name	Value	Comments
supported	yes, no	Focus command supported or not supported

[Auto focus]

[video_server.cam_ctrl.auto_focus.<Parameter name>=<Value>](#)

Parameter name	Value	Comments
supported	yes, no	Auto focus command supported or not supported

[Auto mode]

[video_server.cam_ctrl.auto_mode.<Parameter name>=<Value>](#)

Parameter name	Value	Comments
supported	yes, no	Auto mode supported or not supported >>>Chapter 6.4
type	attract, atpan, seq, patrol, patrol2, patrol3, patrol4, attract_manual	Supported auto mode attract: Auto tracking atpan: Auto pan seq: Preset sequence patrol: Patrol patrol2: Patrol2 patrol3: Patrol3 patrol4: Patrol4 attract_manual: Rock on the target & auto-tracking

[Preset]

[video_server.cam_ctrl.preset.<Parameter name>=<Value>](#)

Parameter name	Value	Comments
supported	yes, no	Preset command supported or not supported >>Chapter 6.5
number	(numerical value)	Number of preset position

6.2. Pan/Tilt/Zoom/Focus

6.2.1. 256 steps pan/tilt and 4 step zoom/focus control

[URL] /cgi-bin/directctrl?dpan=<Value>&dtilt=<Value>&zoom=<Value>[&ch=<Value>]

[Method] GET

[Access level] 2

Parameter name	Value	Comments
dpan	-256 to 256	Set up pan speed -256(fast) to -1(slow):left 1(slow) to 256(fast):right 0 : stop pan motion
dtilt	-256 to 256	Set up tilt speed -256(fast) to -1(slow):upward, 1(slow) to 256(fast):downward 0 : stop tilt motion
zoom	-4 to 4	Set up zoom speed -4(fast) to -1(slow):wide , 1(slow) to 4(fast):tele 0 : stop zoom motion
focus	-4 to 4	Set up focus speed -4(fast) to -1(slow):near, 1(slow) to 4(fast):far 0 : stop focus motion
ch	1, 2, 3, 4	Channel 1: Channel 1 2: Channel 2 3: Channel 3 4: Channel 4 #This parameter is supported by Quad PTZ mode of fisyeve models.

[Command examples]

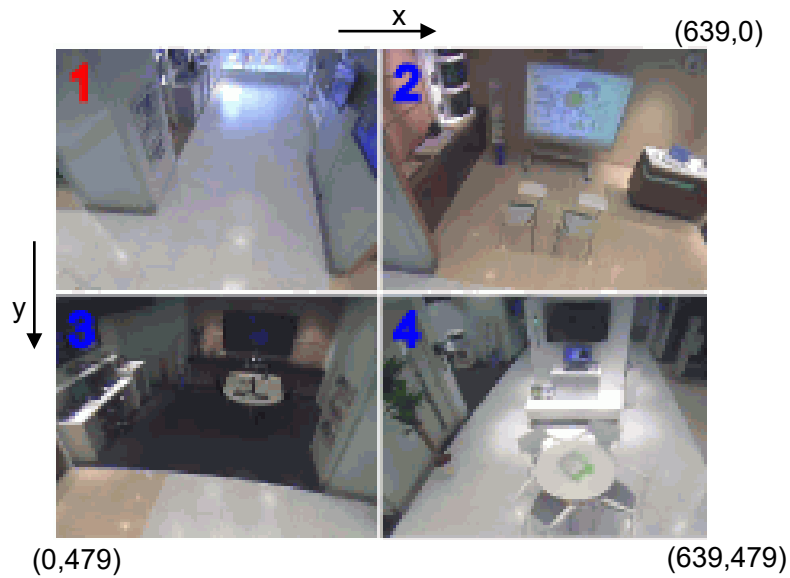
Speed setup (speed 250 for right direction and speed 200 for downward) .

<http://192.168.0.10/cgi-bin/directctrl?dpan=250&dtilt=200&zoom=0>

Speed setup (speed 100 for left direction and speed 150 for downward, speed 4 for tele(zoom)) .

<http://192.168.0.10/cgi-bin/directctrl?dpan=-100&dtilt=150&zoom=4>

[Note for Quad PTZ mode of Fisheye models]



Normalize the clicking point on the GUI to VGA coordinate system (0,0)-(639,479).

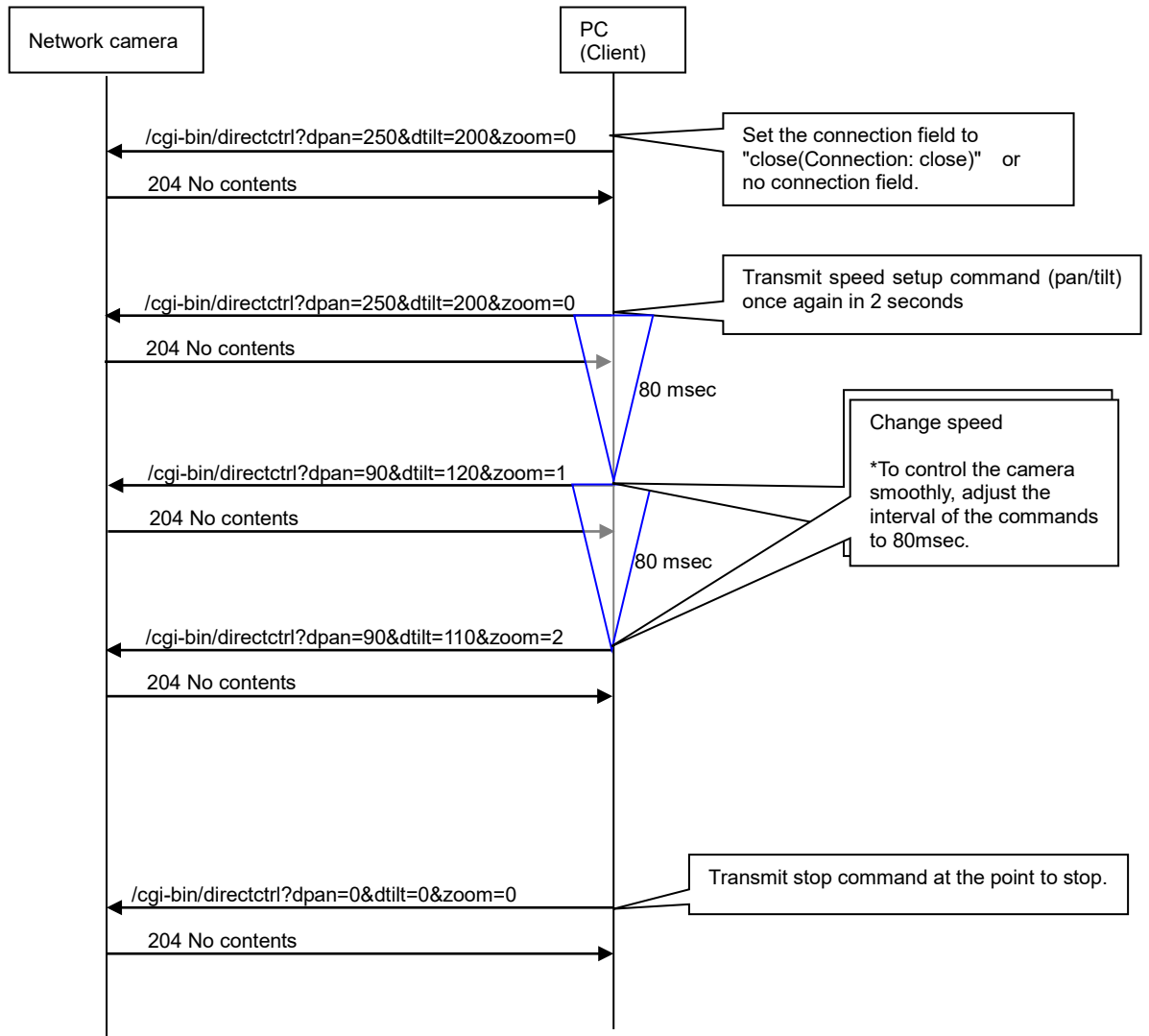
Set ch parameter in the following rule.

- Position 1(x=0 to 319 and y=0 to 239) : Set parameter ch=1,
- Position 2 (x=320 to 639 and y=0 to 239): Set parameter ch=2,
- Position 3 (x=0 to 319 and y=240 to 479): Set parameter ch=3,
- Position 4 (x=320 to 639 and y=240 to 479): Set parameter ch=4.

[Sequence]

Speed setup(256 step) command sequence of the network camera is shown below. Speed setup(256 step) command (pan/tilt) automatically stops after approx. 2 seconds. Therefore, it needs to transmit command continuously for continuous operation.

To control the camera smoothly, adjust the interval of the commands to 80msec.



To control camera more smoothly, set the connection field to "close(Connection: close)" or no connection field.

6.2.2. 256 step pan/tilt and 4 step zoom continuous move control

[URL] /cgi-bin/directctrl?rpan=<Value>&rtilt=<Value>[&rzoom=<Value>][&ch=<Value>]
[Method] GET
[Access level] 2

Parameter name	Value	Comments
rpan	-256 to 256	Specify the pan speed(256 steps) *Camera doesn't stop the motion until receiving "rpan=0" -256(fast) to -1(slow):left 1(slow) to 256(fast):right 0 : stop pan motion
rtilt	-256 to 256	Specify the tilt speed(256 steps) *Camera doesn't the motion until receiving "rtilt=0" -256(fast) to -1(slow):upward 1(slow) to 256(fast):downward 0 : stop tilt motion
rzoom	-4 to 4	Specify the zoom speed *Camera doesn't stop motion until receiving "rzoom=0" -4(fast) to -1(slow):wide 1(slow) to 4(fast):tele 0 : stop zoom motion
ch	1, 2, 3, 4	Channel 1: Channel 1 2: Channel 2 3: Channel 3 4: Channel 4 [Note] #This parameter is supported by Quad PTZ mode of fisyeve models. Refer to chapter 6.2.1

[Command examples]

256 step pan/tilt control (continuous) (speed 250 for right direction and speed 200 for downward) .
<http://192.168.0.10/cgi-bin/directctrl?rpan=250&rtilt=200>

Stop motion

<http://192.168.0.10/cgi-bin/directctrl?rpan=0&rtilt=0>

6.2.3. Auto focus

[URL] /cgi-bin/camctrl?af=on

[Method] GET

[Access level] 2

[Command example]

Auto focus (Auto focus start-up)

<http://192.168.0.10/cgi-bin/camctrl?af=on>

6.2.4. 16 step pan/tilt control

[URL] /cgi-bin/directctrl?pan=<Value>&tilt=<Value>[&ch=<Value>]

[Method] GET

[Access level] 2

Parameter name	Value	Comments
pan	-16 to 16	Set up pan speed(16 step) -16(fast) to -1(slow):left, 1(slow) to 16(fast):right 0 : stop pan motion
tilt	-16 to 16	Set up tilt speed(16 step) -16(fast) to -1(slow):upward , 1(slow) to 16(fast):downward 0 : stop tilt motion
ch	1, 2, 3, 4	Channel 1: Channel 1, 2: Channel 2, 3: Channel 3, 4: Channel 4 #This parameter is supported by Quad PTZ mode of fisyeeye models. Refer to chapter 6.2.1

[Command examples]

Speed setup (speed 15 for right direction and speed 10 for downward) in 16 step command.

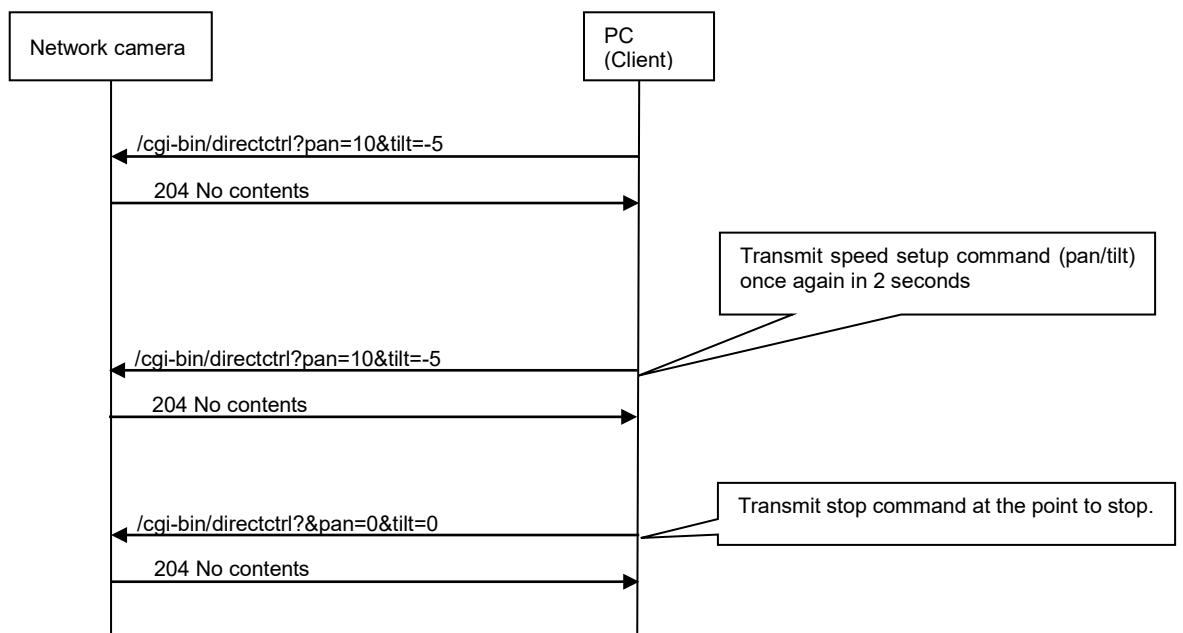
<http://192.168.0.10/cgi-bin/directctrl?pan=15&tilt=10>

Speed setup (PAN, TILT stop)

<http://192.168.0.10/cgi-bin/directctrl?pan=0&tilt=0>

[Sequence]

Speed setup command sequence of the network camera is shown below. Speed setup command (pan/tilt) automatically stops after approx. 2 seconds. Therefore, it needs to transmit command continuously for continuous operation.



6.3. Zoom/Focus for fixed models

6.3.1. Zoom control for Motorized varifocal lens

[URL] /cgi-bin/set_vzoom? [<Parameter name>=<Value>]

[Method] GET

[Access level] 1

Parameter name	Value	Comments
abs_times	100 to 1080	Zooming is performed, and the auto focus function starts automatically. 100: x1.0 1080: x10.8
times	down, up, reset	Adjusting the zoom manually. down: Adjust the zoom ratio to the "Wide" side. up: Adjust the zoom ratio to the "Tele" side reset : Reset the zoom ratio to x1.0

[Command examples]

Starts Zoom/focus adjustment (to x 2.0)

http://192.168.0.10/cgi-bin/set_vzoom?abs_times=200

Adjust the zoom ratio to the 'Tele' side manually

http://192.168.0.10/cgi-bin/set_vzoom?times=up

6.3.2. Get the zoom ratio for Motorized varifocal lens

[URL] /cgi-bin/get_vzoom

[Method] GET

[Access level] 1

[Response examples (e.g. x2.0)]

HTTP/1.1 200OK[0d][0a]

...

[0d][0a]

<html>[0d][0a]

VZOOM=200 [0d][0a]

</html>[0d][0a]

6.3.3. Auto back focus

[URL] /cgi-bin/back_focus? [<Parameter name>=<Value>]

[Method] POST

[Access level] 1

Parameter name	Value	Comments	Parameter to get current setting (/cgi-bin/getdata)
auto	on	ABF	-
manual	far, near, reset	Manual back focus setup far: FAR near: NEAR reset: RESET	-
cl_bw	auto, preset, fix	Adjusting method auto :Auto preset :Preset fix :Fix	CLBW

[Command examples]

ABF setup

http://192.168.0.10/cgi-bin/back_focus?auto=on

Change the adjusting method to auto.

http://192.168.0.10/cgi-bin/back_focus?cl_bw=auto

6.3.4. Extra zoom (for models without Motorized varifocal lens)

[URL] /cgi-bin/set_zoom?times=<Value>

[Method] POST/GET

[Access level] 1

Parameter name	Value	Comments
times	down, reset, up	Extra zoom down: WIDE (1step) reset: Reset to x1 up: TELE (1step)

[Command example]

TELE (1step)

http://192.168.0.10/cgi-bin/set_zoom?times=up

6.4. Automode start and stop

[URL] /cgi-bin/camctrl?atmode=<Value>

[Method] GET

[Access level] 2

Parameter name	Value	Comments
atmode	off atpan seq attrack patrol patrol2 patrol3 patrol4	Off : stop auto mode atpan : start auto pan seq : start preset sequence attrack : start auto tracking patrol : start patrol function patrol2: start patrol2 function patrol3: start patrol3 function patrol4: start patrol4 function

[Command examples]

Auto mode (Auto pan start-up)

<http://192.168.0.10/cgi-bin/camctrl?atmode=atpan>

Auto mode (Preset sequence start-up)

<http://192.168.0.10/cgi-bin/camctrl?atmode=seq>

Auto tracking

<http://192.168.0.10/cgi-bin/camctrl?atmode=attrack>

[Note]

In 'Quad PTZ' stream of fisheye models, auto pan and preset sequence are supported. These functions are worked at **only ch1** in these models.

6.5. Preset position

6.5.1. Move to Preset Position

[URL] /cgi-bin/camctrl?preset=<Value>[&ch=<Value>]

[Method] GET

[Access level] 2

Parameter name	Value	Comments
preset	0 to 256	0 : call home position 1 to 256 : call preset position 1 to 16: Fisheye models
ch	1, 2, 3, 4	Channel 1: Channel 1 2: Channel 2 3: Channel 3 4: Channel 4 #This parameter is supported by Quad PTZ mode of Fisheye models.

[Command examples]

Preset (Call home position)

<http://192.168.0.10/cgi-bin/camctrl?preset=0>

[Quad stream mode of Fisyeeye models]

When using ch parameter, it can move to specified preset position each channel(ch1 - ch4).

When NOT using ch parameter, all channel are moved to the specific preset position as following.

e.g.) Quad stream mode

<http://192.168.0.10/cgi-bin/camctrl?preset=1>

<http://192.168.0.10/cgi-bin/camctrl?preset=2>

<http://192.168.0.10/cgi-bin/camctrl?preset=3>

<http://192.168.0.10/cgi-bin/camctrl?preset=4>

ch1: move to Preset 1, ch2: move to Preset 2, ch3: move to Preset 3, ch4: move to Preset 4

<http://192.168.0.10/cgi-bin/camctrl?preset=5>

<http://192.168.0.10/cgi-bin/camctrl?preset=6>

<http://192.168.0.10/cgi-bin/camctrl?preset=7>

<http://192.168.0.10/cgi-bin/camctrl?preset=8>

ch1: move to Preset 5, ch2: move to Preset 6, ch3: move to Preset 7, ch4: move to Preset 8

<http://192.168.0.10/cgi-bin/camctrl?preset=9>

<http://192.168.0.10/cgi-bin/camctrl?preset=10>

<http://192.168.0.10/cgi-bin/camctrl?preset=11>

<http://192.168.0.10/cgi-bin/camctrl?preset=12>

ch1: move to Preset 9, ch2: move to Preset 10, ch3: move to Preset 11, ch4: move to Preset 12

<http://192.168.0.10/cgi-bin/camctrl?preset=13>

<http://192.168.0.10/cgi-bin/camctrl?preset=14>

<http://192.168.0.10/cgi-bin/camctrl?preset=15>

<http://192.168.0.10/cgi-bin/camctrl?preset=16>

ch1: move to Preset 13, ch2: move to Preset 14, ch3: move to Preset 15, ch4: move to Preset 16

6.5.2. Position setup

[URL] [/cgi-bin/camposiset? \[<Parameter name>=<Value>\]](#)

[Method]POST/ GET

[Access level] 1

Parameter name	Value	Comments	Parameter to get current setting (/cgi-bin/getdata)
presetset	1 to 256	Preset position registration 1 to 256 1 to 16: Fisyeh models	PREPOSI *Enumeration of a number comprised of 0 and 1. 0: Not registered position 1: Registered position.
presetdel	1 to 256	Preset position delete	
reply	none	Response format 'none' fixed value When the parameter is set to 'reply=none', the camera doesn't send after '200OK' as the response.	-

[Command examples]

Position setup (Registration of preset position 1)

<http://192.168.0.10/cgi-bin/camposiset?presetset=1>

Position setup (Delete of preset position 64)

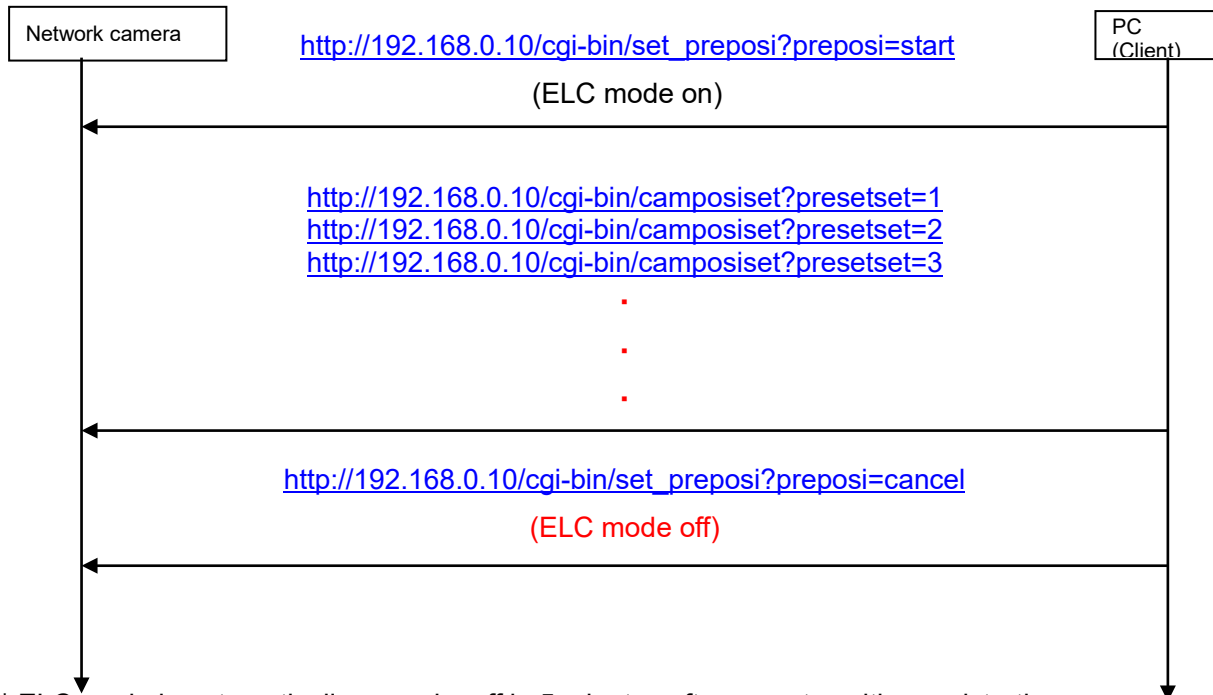
<http://192.168.0.10/cgi-bin/camposiset?presetdel=64>

IMPORTANT

In a preset position, change of the surrounding brightness changes an iris diaphragm.

At this time, depth of field may change and the focus may shift.

In order to prevent this problem, please set up preset positions in the following procedures. (Using ELC mode: Electronic Lighting Control mode)



* ELC mode is automatically come by off in 5 minutes after preset position registration.

6.5.3. Get the preset position information

[URL] /cgi-bin/get_preposi?[<Parameter name>=<Value>]

[Method] GET

[Access level] 1

Parameter name	Value	Comments
command	list, info	list : You can get preset position, registration list, home position, number, and each preset position id. info : information for each preset position.
preno	1 to 256	1 to 256: preset position number. This parameter is valid when "info" is selected for the parameter "command". You can get detailed information for the preset position.

[Command example]

Get the preset position list

http://192.168.0.10/cgi-bin/get_preposi?command=list

[Response example]

```
PRESET_POSITION_REGISTRATION=10...11<0d><0a> #Preset Position list: 1=Registered, 0=Not Registered
HOME=X<0d><0a> #Home Position : 'X'
POS11_ID=POS11<0d><0a> #ID for Preset position 1: 'POS11'
POS12_ID=<0d><0a> #Preset position 2 is not registered.
....
POS1256_ID=256<0d><0a> #ID for Preset position 256: '256'
```

[Command example]

Get the preset position information

http://192.168.0.10/cgi-bin/get_preposi?command=info&preno=1

[Response example]

PRESET_POSITION=1<0d><0a>	#Requested preset position number
ID_DISP=X<0d><0a>	#Display the preset ID (0:Off/1:On)
ID=POS1<0d><0a>	#ID for requested preset position
STOPTIME=X<0d><0a>	#Dwell time
AFMODE=XXXX<0d><0a>	#Auto focus setting (auto/manual)
SD=X<0d><0a>	#Super Dynamic (0:Off/1:On)
BLC=X<0d><0a>	#BLC (0:Off/1:On)
MASK=0010100111...1111<0d><0a>	#Mask area setting (48 digit 0/1)
VMDULX1=X<0d><0a>	#Upper left X coordinates of VMD area 1
VMDULY1=X<0d><0a>	#Upper left Y coordinates of VMD area 1
VMDBRX1=X<0d><0a>	#Lower right X coordinates of VMD area 1
VMDBRY1=X<0d><0a>	#Lower right Y coordinates of VMD area 1
...	
VMDULX4=X<0d><0a>	#Upper left X coordinates of VMD area 4
VMDULY4=X<0d><0a>	#Upper left Y coordinates of VMD area 4
VMDBRX4=X<0d><0a>	#Lower right X coordinates of VMD area 4
VMDBRY4=X<0d><0a>	#Lower right Y coordinates of VMD area 4
VMDSTATUS1=X<0d><0a>	#State for VMD area 1 (enable/disable)
VMDSTATUS2=X<0d><0a>	#State for VMD area 2 (enable/disable)
VMDSTATUS3=X<0d><0a>	#State for VMD area 3 (enable/disable)
VMDSTATUS4=X<0d><0a>	#State for VMD area 4 (enable/disable)
VMDAREA=X<0d><0a>	#Detection threshold of VMD area1
VMDAREA2=X<0d><0a>	#Detection threshold of VMD area2
VMDAREA3=X<0d><0a>	#Detection threshold of VMD area3
VMDAREA4=X<0d><0a>	#Detection threshold of VMD area4
VMDSENSE=X<0d><0a>	#Detection sensitivity of VMD area1
VMDSENSE2=X<0d><0a>	#Detection sensitivity of VMD area2
VMDSENSE3=X<0d><0a>	#Detection sensitivity of VMD area3
VMDSENSE4=X<0d><0a>	#Detection sensitivity of VMD area4
VMDLIGHTC=X<0d><0a>	#Light detection control (0:Off/1:On)

6.5.4. Set dwell time

[URL] /cgi-bin/set_preposi? [<Parameter name>=<Value>]

[Method] POST/GET

[Access level] 1

Parameter name	Value	Comments	Parameter to get current setting (/cgi-bin/getdata)
preno	1 to 256	Preset No.	-
preposiid_display	0, 1	Display the preset ID 0: OFF 1: ON	-
preposiid	1-16 characters	Preset ID Transmit "+" in case of setting a blank column	PREPOSINAME
stoptime	Off, 5,10,15, 20,25,30	dwell time Off: When the preset sequence operates, preset positions that are set to "Off" will not be moved to and the sequence will move to the next position. 5 sec / 10 sec / 15 sec / 20 sec / 25 sec / 30sec	PREPOSISTIME
afmode	auto, manual	Auto focus after preset move auto : auto focus after preset move manual : do not use auto focus	-

[Command examples]

Display preset ID of "preset 30" as "POSI30"

http://192.168.0.10/cgi-bin/set_preposi?preno=30&preposiid_display=1&preposiid=POSI30&stoptime=10

Set the dwell time to "5 sec"

http://192.168.0.10/cgi-bin/set_preposi?preno=1&stoptime=5

6.6. Auto pan setup

6.6.1. Start and end position setup

[URL] /cgi-bin/camposiset?[<Parameter name>=<Value>]
 [Method]POST/ GET
 [Access level] 1

Parameter name	Value	Comments
apanstart	on	Registration of auto pan start position
apanend	on	Registration of auto pan end position
reply	none	Response format('none' fixed value) #When the parameter is set to 'reply=none', the camera doesn't send after '200OK' as the response.

[Command examples]

Position setup (Registration of Auto pan start position)

<http://192.168.0.10/cgi-bin/camposiset?apanstart=on>

6.6.2. Dwell time, speed and endless pan setup

[URL] /cgi-bin/set_autopan?[<Parameter name>=<Value>]
 [Method] POST
 [Access level] 1

Parameter name	Value	Comments	Parameter to get current setting (/cgi-bin/getdata)
apanstoptime	0/1/2/3/4/ 5/10/15/20/ 25/30	Dwell time at the start and the end point 0/1/2/3/4/5/10/15/20/25/30 [seconds]	PTZSTOPTIME
apanspeed	1/2/3/4/5/ 6/7/8/9/10	Speed for the auto panning 1: 3 degree/s 2: 4 degree/s 3: 5 degree/s 4: 7 degree/s 5: 10 degree/s 6: 13 degree/s 7: 18 degree/s 8: 24 degree/s 9: 1 degree/s 10: 2 degree/s	PTZAUTOPAN
apanendless	off/right/left	Off: Pan between the left and right end position points. Right: Pans clockwise Left: Pans counterclockwise.	ENDLESSPAN

[Command example]

13 degree/s (Pan speed) and Pans counterclockwise.

http://192.168.0.10/cgi-bin/set_autopan?apanspeed=6&apanendless=left

6.7. Patrol setup

6.7.1. Select the number of patrol pattern

[URL] /cgi-bin/set_ptrlnum?ptrlnum=<Value>

[Method] POST

[Access level] 1

Parameter name	Value	Comments	Parameter to get current setting (/cgi-bin/getdata)
ptrlnum	1, 2, 3	Selectable patrol pattern. The programmed time varies with the number of patrol pattern. 1: A 2-min. operation can be stored into Patrol 1. 2: A 1-min. operation can be stored into Patrol 1 and Patrol 2 each. 3: A 30-sec. operation can be stored into Patrol 1, Patrol 2, Patrol 3, and Patrol 4 each.	PATROLNO

[Command example]

e.g.) Set 1.

http://192.168.0.10/cgi-bin/set_ptrlnum?ptrlnum=1

6.7.2. Storing the camera operation

[URL] /cgi-bin/set_patrol? [<Parameter name>=<Value>]

[Method] GET

[Access level] 1

Parameter name	Value	Comments
restart	1, 2, 3, 4	Start storing the camera operation to the patrol number selected with the following value. 1 :Patrol number 1, 2 :Patrol number 2 3 :Patrol number 3, 4 :Patrol number 4
stop	1, 2, 3, 4	Stop storing the camera operation to the patrol number selected with the following value. This is useful after starting storing with the 'restart' parameter 1 :Patrol number 1, 2 :Patrol number 2 3 :Patrol number 3, 4 :Patrol number 4
play	1, 2, 3, 4	Demonstrate the stored camera operation to the following patrol number. 1 :Patrol number 1, 2 :Patrol number 2 3 :Patrol number 3, 4 :Patrol number 4

[Command example]

e.g.) Start storing the camera operation to the patrol number 1.

http://192.168.0.10/cgi-bin/set_patrol?restart=1

e.g.) Stop storing the camera operation to the patrol number 1.

http://192.168.0.10/cgi-bin/set_patrol?stop=1

e.g.) Demonstrate the stored camera operation to the patrol number 1.

http://192.168.0.10/cgi-bin/set_patrol?play=1

6.8. Auto track

6.8.1. Lock on target & start auto-tracking manually

[URL]

/cgi-bin/camctrl?manual_attrack=<Value>¢er_x=<Value>¢er_y=<Value>&resolution=<Value>

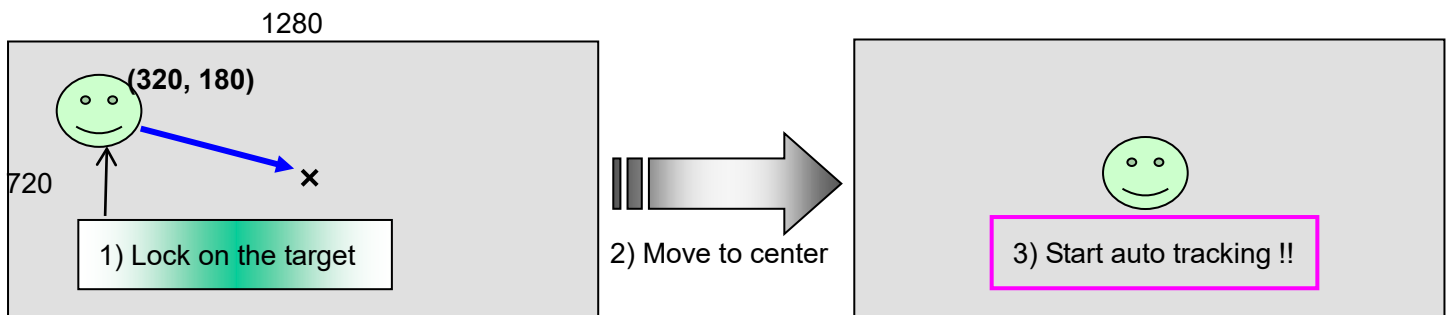
[Method] GET

[Access level] 2

Parameter name	Value	Comments
manual_attrack	0, 1	Lock on target 0: Off 1: On
center_x	0 to 319 0 to 639, 0 to 799 0 to 1279 0 to 1919	X coordinate to be moved to the centering position. 0 to 319: In case the 'resolution' parameter is '320'. 0 to 639: In case the 'resolution' parameter is '640'. 0 to 799: In case the 'resolution' parameter is '800'. 0 to 1279: In case the 'resolution' parameter is '1280'. 0 to 1919: In case the 'resolution' parameter is '1920'.
center_y	[4:3 mode] 0 to 239, 0 to 479, 0 to 599, 0 to 959, [16:9 mode] 0 to 179 0 to 359, 0 to 719, 0 to 1079	Y coordinate to be moved to the centering position. Resolution to be set (4:3) 0 to 239: In case the 'resolution' parameter is '320'. 0 to 479: In case the 'resolution' parameter is '640'. 0 to 599: In case the 'resolution' parameter is '800'. 0 to 959: In case the 'resolution' parameter is '1280'. Resolution to be set (16:9) 0 to 179: In case the 'resolution' parameter is '320'. 0 to 359: In case the 'resolution' parameter is '640'. 0 to 719: In case the 'resolution' parameter is '1280'. 0 to 1079: In case the 'resolution' parameter is '1920'.
resolution	320 640 800 1280 1920	Resolution for image 320: 320x240/320x180 640: 640x480/640x360 800: 800x600 1280: 1280x960/1280x720 1920: 1920x1080

[Command examples]

http://192.168.0.10/cgi-bin/camctrl?manual_attrack=1¢er_x=320¢er_y=180&resolution=1280



6.8.2. Auto track setup

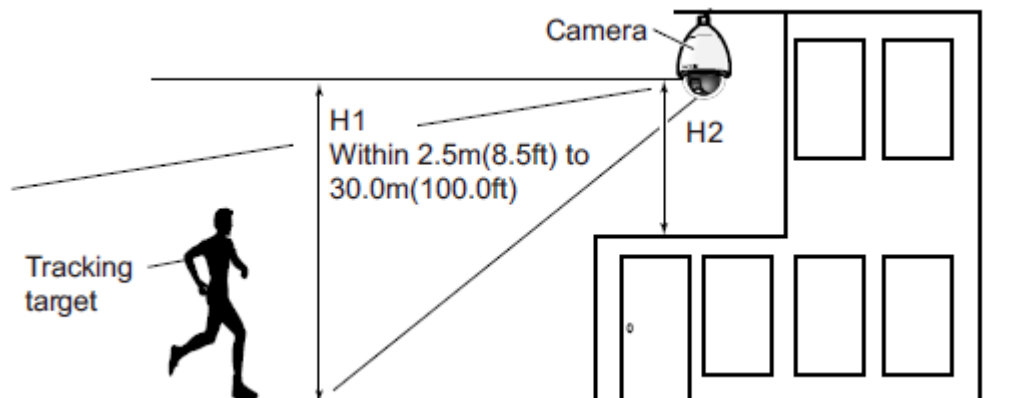
[URL] /cgi-bin/set_attrack? [<Parameter name>=<Value>]

[Method] POST

[Access level] 1

Parameter name	Value	Comments	Parameter to get current setting (/cgi-bin/getdata)
camheight	2.5/2.75/ 3.0/3.25/3.5/3.75/ 4.0/4.25/4.5/4.75/ 5.0/5.5/ 6.0/6.5/ 7.0/7.5/ 8.0/8.5/ 9.0/9.5/ 10.0/12.0/14.0/ 16.0/18.0/20.0/ 22.0/24.0/26.0/ 28.0/30.0	Select the height that the camera is installed to from the following. 2.5m(8.5ft)/2.75m(9.0ft)/3.0m(10.0ft)/3.25m(11.0ft)/3.5m(11.5ft)/3.75m(12.5ft)/4.0m(13.5ft)/4.25m(14.0ft)/4.5m(15.0ft)/4.75m(16.0ft)/5.0m(16.5ft)/5.5m(18.5ft)/6.0m(20.0ft)/6.5m(21.5ft)/7.0(23.5ft)/7.5m(25.0ft)/8.0m(26.5ft)/8.5m(28.5ft)/9.0m(30.0ft)/9.5m(31.5ft)/10.0m(33.5ft)/12.0m(40.0ft)/14.0m(46.5ft)/16.0m(53.5ft)/18.0m(60.0ft)/20.0m(66.5ft)/22.0m(73.5ft)/24.0m(80.0ft)/26.0m(86.5ft)/28.0m(93.5ft)/30.0m(100.0ft)	AT_CAMHEIGHT
alm	off/on/cont	Select an alarm to be used when auto tracking from the following Off: An alarm is not outputted. On: Alarms are continuously outputted during auto tracking. (Outputs are made at 5 second intervals.) cont: Alarms are outputted only once when the auto tracking is continuously performed for a set period.	AT_ALM
detecttime	1/10/30/60/ 180/300	[Alarm wait time] Select a setting time from the following when auto track alarm is set to "On(After alarm wait time)". 1s/10s/30s/60s/180s/300s Default: 10s	AT_DETTIME

The camera height setting is the tracking target's and camera's height (H1: 2.5m(8.5ft)-30.0m(100.0ft)), not H2.Camera.



IMPORTANT

Enter the height for the camera height setting accurately. The detection and tracking capabilities are greatly reduced if the height setting is incorrect.

[Command example]

Select an alarm ON

http://192.168.0.10/cgi-bin/set_attrack?alm=on

6.9. Absolute move control

[URL] /cgi-bin/absctrl?pan=<Value>&tlt=<Value>[&zoom=<Value>&focus=<Value>]

[Method] GET

[Access level] 2

Parameter name	Value	Comments
pan	0 to 3599,	Pan parameter (degree)
tilt	-300 to 900	Tilt parameter (degree)
zoom	10 to 6400	Zoom parameter 10 : x1.0 6400: x640
focus	10 to 9999	Set up focus parameter Setup range : 1.0m to 999.9m 10 : 1.0m 9999 : 999.9m

[Command examples]

Absolute angle setup (PAN160 deg, TILT85 deg, zoom x5.2, focus 100m)

<http://192.168.0.10/cgi-bin/absctrl?pan=1600&tilt=850&zoom=52&focus=1000>

6.10. Get absolute position

[URL] /cgi-bin/absget

[Method] GET

[Access level] 2

[Response]

```
<HTML>
PAN=%abpn%&nbsp;
TILT=%abtl%&nbsp;
ZOOM=%abzm%&nbsp;
FOCUS=%abfc%&nbsp;
STATUS=%abst%&nbsp;
</HTML>
```

%abpn%: (Absolute angle acquisition) value of PAN

%abtl%: (Absolute angle acquisition) value of TILT

%abzm%: (Absolute angle acquisition) value of ZOOM

%abfc%: (Absolute angle acquisition) value of FOCUS

%abst%: Display success/failure status of absolute angle acquisition

-In case of absolute angle acquisition success: STATUS=STOP

-In case of absolute angle acquisition failure: STATUS=MOVE

Acquire this character string as absolute angle since above each character string is substituted.

6.11. Drag & Zoom

[URL]

/cgi-bin/camctrl?sposition_x=<Value>&sposition_y=<Value>&eposition_x=<Value>&eposition_y=<Value>&resolution=<Value>

[Method] GET

[Access level] 2

Parameter name	Value	Comments
sposition_x	0 to 319 0 to 639, 0 to 799, 0 to 1279 0 to 1919	Upper left X coordinates of the dragging area 0 to 319: In case the 'resolution' parameter is '320'. 0 to 639: In case the 'resolution' parameter is '640'. 0 to 799: In case the 'resolution' parameter is '800'. 0 to 1279: In case the 'resolution' parameter is '1280'. 0 to 1919: In case the 'resolution' parameter is '1920'.
sposition_y	0 to 239 0 to 479, 0 to 599 0 to 959 0 to 179 0 to 359 0 to 719 0 to 1079	Upper left Y coordinates of the dragging area Resolution to be set (4:3) 0 to 239: In case the 'resolution' parameter is '320'. 0 to 479: In case the 'resolution' parameter is '640'. 0 to 599: In case the 'resolution' parameter is '800'. 0 to 959: In case the 'resolution' parameter is '1280'. Resolution to be set (16:9) 0 to 179: In case the 'resolution' parameter is '320'. 0 to 359: In case the 'resolution' parameter is '640'. 0 to 719: In case the 'resolution' parameter is '1280'. 0 to 1079: In case the 'resolution' parameter is '1920'.
eposition_x	0 to 319 0 to 639, 0 to 799, 0 to 1279 0 to 1919	Lower right X coordinates of the dragging area
eposition_y	0 to 239 0 to 479, 0 to 599 0 to 959 0 to 179 0 to 359 0 to 719 0 to 1079	Lower right Y coordinates of the dragging area
resolution	320 640 800 1280 1920	Resolution for image 320: 320x240/320x180 640: 640x480/640x360 800: 800x600 1280: 1280x960/1280x720 1920: 1920x1080
ch	1, 2, 3, 4	Channel 1: Channel 1, 2: Channel 2, 3: Channel 3, 4: Channel 4 #This parameter is supported by Quad PTZ mode of fisyeve models. Refer to chapter 6.2.1

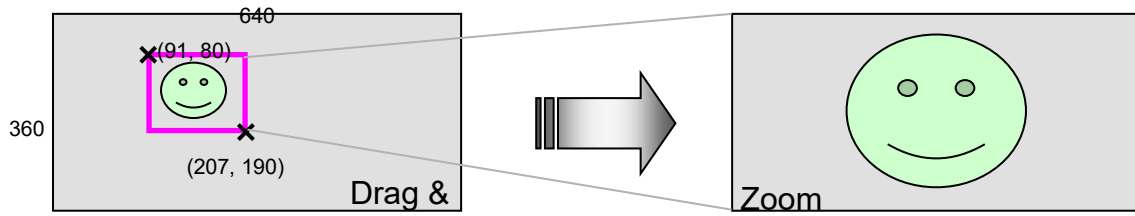
[Command examples]

e.g.) Drag & Zoom command.

Dragging area coordinates:

- Upper left: (91, 80)
- Lower right: (207, 470)
- Resolution: 640x480

http://192.168.0.10/cgi-bin/camctrl?sposition_x=91&sposition_y=80&eposition_x=207&eposition_y=470&resolution=640



e.g.) Drag & Zoom command.

Dragging area coordinates:

- Upper left: (58, 48)
- Lower right: (241, 212)
- Resolution: 320x240

http://192.168.0.10/cgi-bin/camctrl?sposition_x=58&sposition_y=48&eposition_x=241&eposition_y=212&resolution=320

6.12. Click & centering

[URL] /cgi-bin/camctrl?center_x=<Value>¢er_y=<Value>&resolution=<Value>

[Method] GET

[Access level] 2

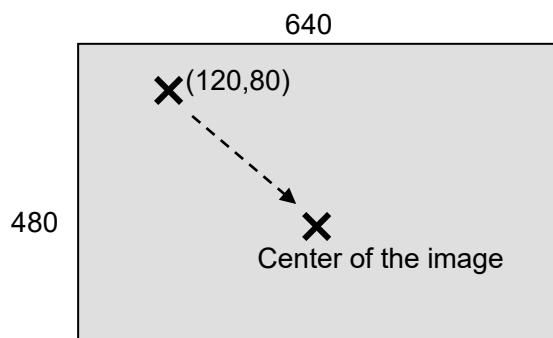
Parameter name	Value	Comments
center_x	0 to 319 0 to 639, 0 to 799, 0 to 1279 0 to 1919	X coordinate to be moved to the centering position. 0 to 319: In case the 'resolution' parameter is '320'. 0 to 639: In case the 'resolution' parameter is '640'. 0 to 799: In case the 'resolution' parameter is '800'. 0 to 1279: In case the 'resolution' parameter is '1280'. 0 to 1919: In case the 'resolution' parameter is '1920'.
center_y	0 to 239 0 to 479, 0 to 599 0 to 959 0 to 179 0 to 359 0 to 719 0 to 1079	Y coordinate to be moved to the centering position. Resolution to be set (4:3) 0 to 239: In case the 'resolution' parameter is '320'. 0 to 479: In case the 'resolution' parameter is '640'. 0 to 599: In case the 'resolution' parameter is '800'. 0 to 959: In case the 'resolution' parameter is '1280'. Resolution to be set (16:9) 0 to 179: In case the 'resolution' parameter is '320'. 0 to 359: In case the 'resolution' parameter is '640'. 0 to 719: In case the 'resolution' parameter is '1280'. 0 to 1079: In case the 'resolution' parameter is '1920'.
resolution	320 640 800 1280 1920	Resolution for image 320: 320x240/320x180 640: 640x480/640x360 800: 800x600 1280: 1280x960/1280x720 1920: 1920x1080
ch	1, 2, 3, 4	Channel 1: Channel 1, 2: Channel 2, 3: Channel 3, 4: Channel 4 #This parameter is supported by Quad PTZ mode of fisyeve models. Refer to chapter 6.2.1

e.g.) Click & centering

- Click coordinate (120, 80)

- Resolution: 640x480

http://192.168.0.10/cgi-bin/camctrl?center_x=120¢er_y=80&resolution=640



6.13. Setup other settings

[URL] /cgi-bin/set_camfunc? [<Parameter name>=<Value>]

[Method] POST

[Access level] 1

Parameter name	Value	Comments	Parameter to get current setting (/cgi-bin/getdata)
hp	0 to 256	Home position setup 0: Delete home position setting. 1 to 256: Preset position number to set home position.	PREHOME
selfreturn	10, 20, 30, 60, 120, 180, 300, 600, 1200, 1800, 3600	Self return time [seconds] 10 :10 sec ... 3600 :3600 sec(60 min)	PRESELF
atmode	off, atpan, seq, attract, hp, patrol1	Self return - When the time set for 'Self return' has passed after manual operations of the camera, the camera will automatically be in the selected mode. off :OFF hp :Home position attract :Auto track atpan :Auto pan seq :Preset sequence patrol1 :Patrol 1	PREAUTO
elzoom	0, 1	EL-zoom 0 :OFF(not use the electronic zoom) 1 :ON	ZOOM
ptz_display	0, 1	Pan –Tilt degree/Zoom ratio display 0 :OFF,1 :ON	PTZDPMODE
display_operation	0, 1	When the camera is operating automatically, the operation mode is displayed.	-
tlimit	10, 5, 3,0 -3, -5, -10, -15, -20, -25, -30	Tilt Angle (Maximum degree for tilting) 10:10 degree ... 0: 0 degree, ... -30: -30degree	PTZTILT
pt_operability	profile1, profile2, profile3	Pan/Tilt operability setup profile1 : for i-PRO system profile2 : for other vendors' system profile3 : for other vendors' system	-

Parameter name	Value	Comments	Parameter to get current setting (/cgi-bin/getdata)
ir_afmode	mode1, off	Auto focus mode at preset position (for IR LED model) mode1 : use special auto focus suitable for IR LED after preset move off : do not use special auto focus In using mode1, please set "manual" for auto focus setup at the preset position. >>>Chapter6.5.4	-
privacy_max	8, 32	The number of privacy zone 8 : Maximum 8 32: Maximum 32	

[Command example]

Set Home position to preset position 10.

http://192.168.0.10/cgi-bin/set_camfunc?hp=10

Set Self return time: 10 sec, Self return: Auto track.

http://192.168.0.10/cgi-bin/set_camfunc?selfreturn=10&atmode=attract

7. Alarm

7.1. I/O

7.1.1. AUX terminal control

[URL] /cgi-bin/pioctrl?almtrm=<Value>

[Method] GET

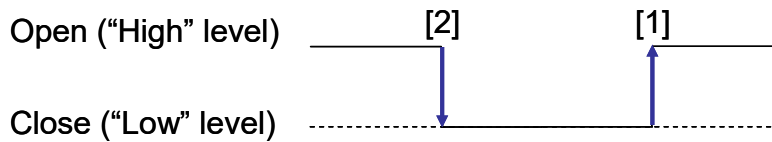
[Access level] 2

Parameter name	Value	Comments
almtrm	no/nc	no : AUX output open (High level) nc : AUX output close (Low level)

[Command examples]

AUX terminal OPEN

<http://192.168.0.10/cgi-bin/pioctrl?almtrm=no>



[1] In order to open the terminal (High level), use 'almtrm=no'.

[2] In order to close the terminal (Low level), use 'almtrm=nc'.

[Get AUX status]

CGI: /cgi-bin/getdata

Related response

Parameter name	Value	Comments
AUXSTATUS	open, close, off	AUX STATUS open: OPEN, close: CLOSE, off: OFF

7.1.2. Terminal setup

[URL] /cgi-bin/jpeg_alarm?[<Parameter name>=<Value>]

[Method] POST

[Access level] 1

Parameter name	Value	Comments	Parameter to get current setting (/cgi-bin/getdata)
trm_alarm	0, 1, 4, 10	Terminal 1 0 : OFF 1 : Alarm input(ON) 4 : BW/color select terminal (Toggles between black & white and color) 10 : Auto time adjustment	ATRMIN
trm_alarm2	0, 1, 2	Terminal 2 0 : OFF 1 : Alarm input(ON), 2 : Alarm output	ATRMIN2
trm_alarm3	0, 1, 2, 3	Terminal 3 0 : OFF 1 : Alarm input(ON), 2 : Alarm output 3 : Aux output	ATRMIN3
trm_alarm1_op_cl	0,1	Terminal 1 when Alarm input is selected. 0: Close An alarm is detected when the terminal status is changed to "Close". 1:Open An alarm is detected when the terminal status is changed to "Open".	AINMODE no : Close is set (normally open) nc : Open is set (normally close)
trm_alarm2_op_cl	0,1	Terminal 2 when Alarm input is selected.	AINMODE2
trm_alarm3_op_cl	0,1	Terminal 3 when Alarm input is selected.	AINMODE3

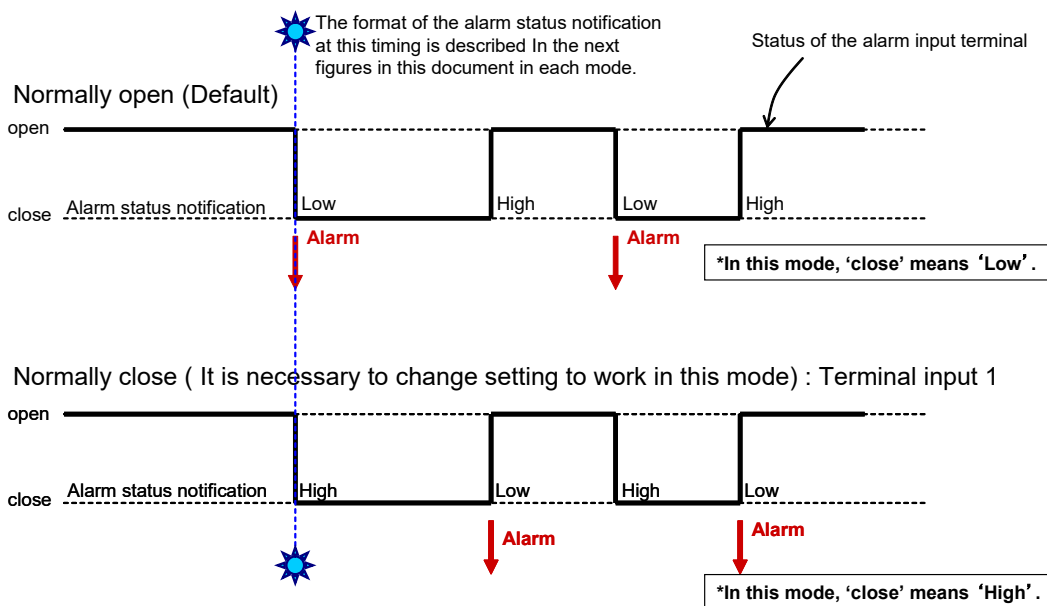
[Command example]

Set Terminal alarm1: Alarm input, Terminal alarm 2: Alarm input

http://192.168.0.10/cgi-bin/jpeg_alarm?trm_alarm=1&trm_alarm2=1

[Description]

The following figure describes the alarm terminal input the status when the setting is normally open or normally close.



- 'Alarm' means the functions such as 'Panasonic alarm protocol (TCP notification)', Mail notification, etc.

- 'Alarm status notification' is described as next figures.

7.1.3. Alarm output terminal setup

[URL] /cgi-bin/alarm_out? [<Parameter name>=<Value>]

[Method] POST

[Access level] 1

Parameter name	Value	Comments	Parameter to get current setting (/cgi-bin/getdata)
alarm_out	0, 1	Determine whether or not to output the alarm signal to the alarm output terminal 0: OFF ,1 : ON	ATRMOUT
alarm_trm	latch, pulse	Alarm output type at an alarm occurrence latch : Latch pulse : Pulse	ATRMMODE
initial	open, close	Trigger output open :The alarm output terminal will open when outputting the alarm signals (Normally close) close :The alarm output terminal will close when outputting the alarm signals. (Normally open)	AOUTMODE
pulse_width	1 to 120	Pulse width setting, when the "Pulse" is set to "Alarm output type". 1 to 120 sec.	APULSEWIDE
alarm_sd	0,1	SD memory card error On: When an error status is detected, the signals from an output terminal is outputted and the [Alarm occurrence indication] button on the "Live" page blinks. Off: Deactivates the warning status detection.	-

[Command example]

Set alarm output terminal: ON, Latch, Normally close.

http://192.168.0.10/cgi-bin/alarm_out?alarm_out=1&alarm_trm=latch&initial=open

Set alarm output terminal: ON, Pulse, Normally close, pulse width: 5sec.

http://192.168.0.10/cgi-bin/alarm_out?alarm_out=1&alarm_trm=pulse&initial=open&pulse_width=5

7.1.4. Alarm Reset

[URL] /cgi-bin/alarm_reset?display=suspend

[Method] GET

[Access level] 2

Parameter name	Value	Comments
display	suspend	suspend fixed

[Command examples]

Alarm Reset

http://192.168.0.10/cgi-bin/alarm_reset?display=suspend

7.1.5. Capability information

CGI: /cgi-bin/get_capability

Related response:

video_server.peripheral.io.<Parameter name>=<Value>

Parameter name	Value	Comments
number	(numerical value)	The number of terminal input/output
trm1	alm_in, alm_out, aux_out, bw_in, clk_in	Function list that the terminal 1 has. alm_in : Terminal alarm input alm_out : Terminal alarm output aux_out : AUX output bw_in : Terminal input for black & white input clk_in: Auto time adjustment
trm2	alm_in, alm_out, aux_out, bw_in	Function list that the terminal 2 has.
trm3	alm_in, alm_out, aux_out, bw_in	Function list that the terminal 3 has.

7.2. VMD (Video Motion Detection) setup

7.2.1. VMD area setup

[URL] /cgi-bin/set_vmdarea? [<Parameter name>=<Value>][&preno=<Value>][&ch=<Value>]

[Method] POST

[Access level] 1

Parameter name	Value	Comments	Parameter to get current setting (/cgi-bin/getdata)
area1_ulx	0 to 639	Upper left X coordinates of VMD area 1 0 to 639	VMDULX1
area1_uly	0 to 639	Upper left Y coordinates of VMD area 1 0 to 639	VMDULY1
area1_brx	0 to 639	Lower right X coordinates of VMD area 1	VMDBRX1
area1_bry	0 to 639	Lower right Y coordinates of VMD area 1	VMDBRY1
area2_ulx	0 to 639	Upper left X coordinates of VMD area 2	VMDULX2
area2_uly	0 to 639	Upper left Y coordinates of VMD area 2	VMDULY2
area2_brx	0 to 639	Lower right X coordinates of VMD area 2	VMDBRX2
area2_bry	0 to 639	Lower right Y coordinates of VMD area 2	VMDBRY2
area3_ulx	0 to 639	Upper left X coordinates of VMD area 3	VMDULX3
area3_uly	0 to 639	Upper left Y coordinates of VMD area 3	VMDULY3
area3_brx	0 to 639	Lower right X coordinates of VMD area 3	VMDBRX3
area3_bry	0 to 639	Lower right Y coordinates of VMD area 3	VMDBRY3
area4_ulx	0 to 639	Upper left X coordinates of VMD area 4	VMDULX4
area4_uly	0 to 639	Upper left Y coordinates of VMD area 4	VMDULY4
area4_brx	0 to 639	Lower right X coordinates of VMD area 4	VMDBRX4
area4_bry	0 to 639	Lower right Y coordinates of VMD area 4	VMDBRY4
area1_state	enable , disable	Status of VMD area 1 enable : Use area 1 disable : Not use area 1	VMDSTATUS1
area2_state	enable , disable	Status of VMD area 2	VMDSTATUS2
area3_state	enable , disable	Status of VMD area 3	VMDSTATUS3
area4_state	enable , disable	Status of VMD area 4	VMDSTATUS4
area_sens	1 to 15	Detection sensitivity of VMD area 1	VMDSENSE1
area_sens2	1 to 15	Detection sensitivity of VMD area 2	VMDSENSE2
area_sens3	1 to 15	Detection sensitivity of VMD area 3	VMDSENSE3
area_sens4	1 to 15	Detection sensitivity of VMD area 4	VMDSENSE4
suspend_ld	0, 1	Light detection control 0: OFF, 1: ON	VMDLIGHTC
preno	0 , 1-256	Preset position number to configure the area. 0: Without the preset positions 1-256: Preset positions #This parameter is supported by PTZ models.	-
area1_th	1 to 10	Detection threshold of area1	VMDAREA
area2_th	1 to 10	Detection threshold of area2	VMDAREA2
area3_th	1 to 10	Detection threshold of area3	VMDAREA3
area4_th	1 to 10	Detection threshold of area4	VMDAREA4

Parameter name	Value	Comments	Parameter to get current setting (/cgi-bin/getdata)
ch	1, 2, 3, 4	Channel 1: Channel 1, 2: Channel 2 , 3: Channel 3, 4: Channel 4 #This parameter is supported by Multi-sensor models. When this parameter is omitted, it works as all channel.	-

[Command example for fixed camera]

Set the following VMD areas.

Area 1: Upper left(35,121), Lower right(262,217), Threshold: 1, Enable, Sensitivity: 15

Area 2: Upper left(184,90), Lower right(610,366), Threshold: 6, Enable, Sensitivity: 6

Area 3: Upper left(83,262), Lower right (473,374), Threshold: 6, Enable, Sensitivity: 1

Light detection control: Off

http://192.168.0.10/cgi-bin/set_vmdarea?area1_ulx=35&area1_uly=121&area1_brx=262&area1_bry=317&area2_ulx=184&area2_uly=90&area2_brx=610&area2_bry=366&area3_ulx=83&area3_uly=262&area3_brx=473&area3_bry=374&area1_th=1&area2_th=6&area3_th=6&area1_state=enable&area2_state=enable&area3_state=enable&area_sens=15&area_sens2=6&area_sens3=1&suspend Id=0

[Command example for PTZ camera]

Set the following VMD areas to the preset 5 position.

Area 1: Upper left(35,121), Lower right(262,217), Threshold: 1, Enable, Sensitivity: 15

Area 2: Upper left(184,90), Lower right(610,366), Threshold: 6, Enable, Sensitivity: 6

Area 3: Upper left(83,262), Lower right (473,374), Threshold: 6, Enable, Sensitivity: 1

Light detection control: Off

http://192.168.0.10/cgi-bin/set_vmdarea?preno=5&area1_ulx=35&area1_uly=121&area1_brx=262&area1_bry=317&area2_ulx=184&area2_uly=90&area2_brx=610&area2_bry=366&area3_ulx=83&area3_uly=262&area3_brx=473&area3_bry=374&area1_th=1&area2_th=6&area3_th=6&area1_state=enable&area2_state=enable&area3_state=enable&area_sens=15&area_sens2=6&area_sens3=1&suspend Id=0

Set the following VMD areas to without preset position.

Area 1: Upper left(35,121), Lower right(262,217), Threshold: 1, Enable, Sensitivity: 15

Area 2: Upper left(184,90), Lower right(610,366), Threshold: 6, Enable, Sensitivity: 6

Area 3: Upper left(83,262), Lower right (473,374), Threshold: 6, Enable, Sensitivity: 1

Light detection control: Off

http://192.168.0.10/cgi-bin/set_vmdarea?preno=0&area1_ulx=35&area1_uly=121&area1_brx=262&area1_bry=317&area2_ulx=184&area2_uly=90&area2_brx=610&area2_bry=366&area3_ulx=83&area3_uly=262&area3_brx=473&area3_bry=374&area1_th=1&area2_th=6&area3_th=6&area1_state=enable&area2_state=enable&area3_state=enable&area_sens=15&area_sens2=6&area_sens3=1&suspend Id=0

[Command example for X8570, S8530]

Set the following VMD areas to CH2.

Area 1: Upper left(35,121), Lower right(262,217), Threshold: 1, Enable, Sensitivity: 15

Area 2: Upper left(184,90), Lower right(610,366), Threshold: 6, Enable, Sensitivity: 6

Area 3: Upper left(83,262), Lower right (473,374), Threshold: 6, Enable, Sensitivity: 1

http://192.168.0.10/cgi-bin/set_vmdarea?area1_ulx=35&area1_uly=121&area1_brx=262&area1_bry=317&area2_ulx=184&area2_uly=90&area2_brx=610&area2_bry=366&area3_ulx=83&area3_uly=262&area3_brx=473&area3_bry=374&area1_th=1&area2_th=6&area3_th=6&area1_state=enable&area2_state=enable&area3_state=enable&area_sens=15&area_sens2=6&area_sens3=1&ch=2

[Command examples to delete VMD area]

To delete VMD area 1

http://192.168.0.10/cgi-bin/set_vmdarea?area=1&area1_ulx=0&area1_uly=0&area1_brx=0&area1_bry=0

To delete VMD area 1 for preset position 3

http://192.168.0.10/cgi-bin/set_vmdarea?area=1&area1_ulx=0&area1_uly=0&area1_brx=0&area1_bry=0&preno=3

7.2.2. Get current setting for PTZ camera

Refer to chapter 6.5.3

7.2.3. Get current setting for Multi-sensor models, CH2, CH3, and CH4

CGI: /cgi-bin/getdata

Parameter name	Comments
VMDULX1_CH2	Upper left X coordinates of VMD area 1 (Ch2)
VMDULY1_CH2	Upper left Y coordinates of VMD area 1 (Ch2)
VMDBRX1_CH2	Lower right X coordinates of VMD area 1 (Ch2)
VMDBRY1_CH2	Lower right Y coordinates of VMD area 1 (Ch2)
VMDULX2_CH2	Upper left X coordinates of VMD area 2 (Ch2)
VMDULY2_CH2	Upper left Y coordinates of VMD area 2 (Ch2)
VMDBRX2_CH2	Lower right X coordinates of VMD area 2 (Ch2)
VMDBRY2_CH2	Lower right Y coordinates of VMD area 2 (Ch2)
VMDULX3_CH2	Upper left X coordinates of VMD area 3 (Ch2)
VMDULY3_CH2	Upper left Y coordinates of VMD area 3 (Ch2)
VMDBRX3_CH2	Lower right X coordinates of VMD area 3 (Ch2)
VMDBRY3_CH2	Lower right Y coordinates of VMD area 3 (Ch2)
VMDULX4_CH2	Upper left X coordinates of VMD area 4 (Ch2)
VMDULY4_CH2	Upper left Y coordinates of VMD area 4 (Ch2)
VMDBRX4_CH2	Lower right X coordinates of VMD area 4 (Ch2)
VMDBRY4_CH2	Lower right Y coordinates of VMD area 4 (Ch2)
VMDULX1_CH3	Upper left X coordinates of VMD area 1 (Ch3)
VMDULY1_CH3	Upper left Y coordinates of VMD area 1 (Ch3)
VMDBRX1_CH3	Lower right X coordinates of VMD area 1 (Ch3)
VMDBRY1_CH3	Lower right Y coordinates of VMD area 1 (Ch3)
VMDULX2_CH3	Upper left X coordinates of VMD area 2 (Ch3)
VMDULY2_CH3	Upper left Y coordinates of VMD area 2 (Ch3)
VMDBRX2_CH3	Lower right X coordinates of VMD area 2 (Ch3)
VMDBRY2_CH3	Lower right Y coordinates of VMD area 2 (Ch3)
VMDULX3_CH3	Upper left X coordinates of VMD area 3 (Ch3)
VMDULY3_CH3	Upper left Y coordinates of VMD area 3 (Ch3)
VMDBRX3_CH3	Lower right X coordinates of VMD area 3 (Ch3)
VMDBRY3_CH3	Lower right Y coordinates of VMD area 3 (Ch3)
VMDULX4_CH3	Upper left X coordinates of VMD area 4 (Ch3)
VMDULY4_CH3	Upper left Y coordinates of VMD area 4 (Ch3)
VMDBRX4_CH3	Lower right X coordinates of VMD area 4 (Ch3)
VMDBRY4_CH3	Lower right Y coordinates of VMD area 4 (Ch3)
VMDULX1_CH4	Upper left X coordinates of VMD area 1 (Ch4)
VMDULY1_CH4	Upper left Y coordinates of VMD area 1 (Ch4)
VMDBRX1_CH4	Lower right X coordinates of VMD area 1 (Ch4)
VMDBRY1_CH4	Lower right Y coordinates of VMD area 1 (Ch4)
VMDULX2_CH4	Upper left X coordinates of VMD area 2 (Ch4)
VMDULY2_CH4	Upper left Y coordinates of VMD area 2 (Ch4)
VMDBRX2_CH4	Lower right X coordinates of VMD area 2 (Ch4)
VMDBRY2_CH4	Lower right Y coordinates of VMD area 2 (Ch4)
VMDULX3_CH4	Upper left X coordinates of VMD area 3 (Ch4)
VMDULY3_CH4	Upper left Y coordinates of VMD area 3 (Ch4)
VMDBRX3_CH4	Lower right X coordinates of VMD area 3 (Ch4)
VMDBRY3_CH4	Lower right Y coordinates of VMD area 3 (Ch4)
VMDULX4_CH4	Upper left X coordinates of VMD area 4 (Ch4)
VMDULY4_CH4	Upper left Y coordinates of VMD area 4 (Ch4)

Parameter name	Comments
VMDBRX4_CH4	Lower right X coordinates of VMD area 4 (Ch4)
VMDBRY4_CH4	Lower right Y coordinates of VMD area 4 (Ch4)
VMDSTATUS1_CH2	Status of VMD area 1 (Ch2)
VMDSTATUS2_CH2	Status of VMD area 2 (Ch2)
VMDSTATUS3_CH2	Status of VMD area 3 (Ch2)
VMDSTATUS4_CH2	Status of VMD area 4 (Ch2)
VMDSTATUS1_CH3	Status of VMD area 1 (Ch3)
VMDSTATUS2_CH3	Status of VMD area 2 (Ch3)
VMDSTATUS3_CH3	Status of VMD area 3 (Ch3)
VMDSTATUS4_CH3	Status of VMD area 4 (Ch3)
VMDSTATUS1_CH4	Status of VMD area 1 (Ch4)
VMDSTATUS2_CH4	Status of VMD area 2 (Ch4)
VMDSTATUS3_CH4	Status of VMD area 3 (Ch4)
VMDSTATUS4_CH4	Status of VMD area 4 (Ch4)
VMDSENSE_CH2	Detection sensitivity of VMD area 1 (Ch2)
VMDSENSE2_CH2	Detection sensitivity of VMD area 2 (Ch2)
VMDSENSE3_CH2	Detection sensitivity of VMD area 3 (Ch2)
VMDSENSE4_CH2	Detection sensitivity of VMD area 4 (Ch2)
VMDSENSE_CH3	Detection sensitivity of VMD area 1 (Ch3)
VMDSENSE2_CH3	Detection sensitivity of VMD area 2 (Ch3)
VMDSENSE3_CH3	Detection sensitivity of VMD area 3 (Ch3)
VMDSENSE4_CH3	Detection sensitivity of VMD area 4 (Ch3)
VMDSENSE_CH4	Detection sensitivity of VMD area 1 (Ch4)
VMDSENSE2_CH4	Detection sensitivity of VMD area 2 (Ch4)
VMDSENSE3_CH4	Detection sensitivity of VMD area 3 (Ch4)
VMDSENSE4_CH4	Detection sensitivity of VMD area 4 (Ch4)
VMDAREA_CH2	Detection threshold of area1 (Ch2)
VMDAREA2_CH2	Detection threshold of area2 (Ch2)
VMDAREA3_CH2	Detection threshold of area3 (Ch2)
VMDAREA4_CH2	Detection threshold of area4 (Ch2)
VMDAREA_CH3	Detection threshold of area1 (Ch3)
VMDAREA2_CH3	Detection threshold of area2 (Ch3)
VMDAREA3_CH3	Detection threshold of area3 (Ch3)
VMDAREA4_CH3	Detection threshold of area4 (Ch3)
VMDAREA_CH4	Detection threshold of area1 (Ch4)
VMDAREA2_CH4	Detection threshold of area2 (Ch4)
VMDAREA3_CH4	Detection threshold of area3 (Ch4)
VMDAREA4_CH4	Detection threshold of area4 (Ch4)

7.2.4. Capability information

CGI: /cgi-bin/get_capability

Related response:

[Overview]

`video_server.vmd.<Parameter name>=<Value>`

Parameter name	Value	Comments
supported	yes, no	VMD function supported or not supported
area_num	(numerical number)	The number of VMD area

[Available parameter range for each image ratio]

4:3 mode

`video_server.vmd.area_4_3.x.min=<numerical number>`

The minimum value of the X coordinates which can setup for VMD area(ex.0)

`video_server.vmd.area_4_3.x.max=<numerical number>`

The maximum value of the X coordinates which can setup for VMD area(ex.639)

`video_server.vmd.area_4_3.y.min=<numerical number>`

The minimum value of the Y coordinates which can setup for VMD area(ex.0)

`video_server.vmd.area_4_3.y.max=<numerical number>`

The maximum value of the Y coordinates which can setup for VMD area(ex.479)

16:9 mode

`video_server.vmd.area_16_9.x.min=<numerical number>`

The minimum value of the X coordinates which can setup for VMD area(ex.0)

`video_server.vmd.area_16_9.x.max=<numerical number>`

The maximum value of the X coordinates which can setup for VMD area(ex.639)

`video_server.vmd.area_16_9.y.min=<numerical number>`

The minimum value of the Y coordinates which can setup for VMD area(ex.60)

`video_server.vmd.area_16_9.y.max=<numerical number>`

The maximum value of the Y coordinates which can setup for VMD area(ex.419)

16:9 rotate (90deg. 270deg) mode.

`video_server.vmd.area_16_9_rotate.x.min=<numerical number>`

The minimum value of the X coordinates which can setup for VMD area(ex.0)

`video_server.vmd.area_16_9_rotate.x.max=<numerical number>`

The maximum value of the X coordinates which can setup for VMD area(ex.359)

`video_server.vmd.area_16_9_rotate.y.min=<numerical number>`

The minimum value of the Y coordinates which can setup for VMD area(ex.0)

`video_server.vmd.area_16_9_rotate.y.max=<numerical number>`

The maximum value of the Y coordinates which can setup for VMD area(ex.639)

`video_server.vmd.detect_sens.step=<numerical number>`

Available value of sensitivity setting(ex.15)

`video_server.vmd.detect_area_size.step=<numerical number>`

Available value of area size in the VMD area.(ex.10)

7.3. i-VMD (intelligent VMD) /AI-VMD setup

To activate this feature, you need to install the WV-SAE200W / WV-XAE200W software to the camera.

For details, refer to the Operating Instructions of WV-SAE200W / WV-XAE200W.

The result data can be acquired as additional information with H.264/H.265 and JPEG stream and so on.

(Refer to chapter 13)

7.3.1. Capability information

CGI: /cgi-bin/get_capability

Related response:

`video_server.ivmd.<Parameter name>=<Value>`

Parameter name	Value	Comments
supported	yes, no	i-VMD function supported or not supported
mode	intruder, loitering, direction, scenechg, object, crossline	Supported i-VMD detection type intruder: Intruder detection loitering: Loitering detection direction: Direction detection scenechg: Scene change detection object: Object detection crossline: Cross line detection
condition_num	(numerical value)	The number of Detection program value e.g.) 2

7.3.2. Detection type setup

[URL] /cgi-bin/jpeg_alarm?vmd_func=<Value>

[Method] GET/POST

[Access level] 1

Parameter name	Value	Comments	Parameter to get current setting (/cgi-bin/getdata)
vmd_func	0, 1	VMD function type 0: VMD 1: i-VMD	AVMDFUNCTYPE

[Command examples]

Set the VMD function type to i-VMD.

http://192.168.0.10/cgi-bin/jpeg_alarm?vmd_func=1

Other settings (ex. area, kind) can be set on web browser.

7.3.3. Schedule setup

Refer to chapter 12

7.3.4. i-VMD detailed setup (advanced setting)

[URL] /cgi-bin/set_ivmd_detail?[<Parameter name>=<Value>]

[Method] GET/POST

[Access level] 1

Parameter name	Value	Comments	Parameter to get current setting (/cgi-bin/getdata)
sens_level	1 to 7	Detection sensitivity 1(Low) to 7(High)	IVMDSSENSLEVEL
okizari_sens	2,3,4	Detection sensitivity (Object detection) 2(Low) to 4(High)	IVMDOBJLEVEL
scenechg_size	1 to 5	Scene change detection level 1(Low) to 5(High)	IVMDSCDLEVEL
intruder_time	0.2,0.4, 1,2, 3,4, 5,10, reset	Intruder detection time 0.2 : 0.2s, 0.4 : 0.4s, 1 : 1s 2 : 2s, 3 : 3s, 4 : 4s 5 : 5s, 10 : 10s reset : Reset to default value	IVMDINTTIME
loitering_time	10, 20, 30, 60, 120, 180, 300, reset	Loitering detection time 10 : 10s 20 : 20s 30 : 30s 60 : 1min 120 : 2min 180 : 3min 300 : 5min reset : Reset to default value	IVMDLOITIME
direction_time	1, 2, 3, 4, 5, 10, reset	Direction detection time 1 : 1s 2 : 2s 3 : 3s 4 : 4s 5 : 5s 10 : 10s reset : Reset to default value	IVMDDIRTIME
okizari_time	10, 20, 30, 60, 120, 180, 300, reset	Object detection time 10 : 10s 20 : 20s 30 : 30s 60 : 1min 120 : 2min 180 : 3min 300 : 5min reset : Reset to default value	IVMDOBJTIME
scenechg_time	1, 2, 3, 4, 5, 10, reset	Scene change detection time 1 : 1s 2 : 2s 3 : 3s 4 : 4s 5 : 5s 10 : 10s reset : Reset to default value	IVMDSCDTIME

[Command examples]

Set Detection sensitivity to 5, Intruder detection time to 1s.

http://192.168.0.10/cgi-bin/set_ivmd_detail?sens_level=5&intruder_time=1

7.3.5. i-VMD detection size setup (advanced setting)

[URL] /cgi-bin/set_ivmd_size?[<Parameter name>=<Value>]

[Method] GET/POST

[Access level] 1

Parameter name	Value	Comments	Parameter to get current setting (/cgi-bin/getdata)
size_min	10, 20, 30, 40, 50, 60, 70, 80, 90, reset	Min. size 10 : 10% 20 : 20% 30 : 30% 40 : 40% 50 : 50% 60 : 60% 70 : 70% 80 : 80% 90 : 90% reset : Reset to default value	IVMDMINSIZE
size_max	100, 150, 200, 250, 300, 350, 400, 450, 500, 1000, reset	Max. size 100 : 100% 150 : 150% 200 : 200% 250 : 250% 300 : 300% 350 : 350% *1 400 : 400% *1 450 : 450% *1 500 : 500% *1 1000 : Unlimited *1 reset : Reset to default value	IVMDMAXSIZE

*1: This parameter is only supported by the cameras which support WV-SAE200 Type2 and Type4.

[Command example]

Set Min. size to 30%.

http://192.168.0.10/cgi-bin/set_ivmd_size?size_min=30

7.3.6. Get current other settings

CGI: /cgi-bin/getdata

Parameter name	Value	Comments
IVMD1TITLE	Characters	Detection program 1 title
IVMD1STATUS1	0, 1	Detection program 1 Area 1 Status 0: Off, 1:On
IVMD1STATUS2	0, 1	Detection program 1 Area 2 Status
IVMD1STATUS3	0, 1	Detection program 1 Area 3 Status
IVMD1STATUS4	0, 1	Detection program 1 Area 4 Status
IVMD1STATUS5	0, 1	Detection program 1 Area 5 Status
IVMD1STATUS6	0, 1	Detection program 1 Area 6 Status
IVMD1STATUS7	0, 1	Detection program 1 Area 7 Status
IVMD1STATUS8	0, 1	Detection program 1 Area 8 Status
IVMD1MODE1	1, 2, 3, 4, 5	Detection program 1 Area 1 mode 1: Intruder 2: Loitering 3: Direction 4: Object 5: Cross line
IVMD1MODE2	1, 2, 3, 4, 5	Detection program 1 Area 2 mode
IVMD1MODE3	1, 2, 3, 4, 5	Detection program 1 Area 3 mode
IVMD1MODE4	1, 2, 3, 4, 5	Detection program 1 Area 4 mode
IVMD1MODE5	1, 2, 3, 4, 5	Detection program 1 Area 5 mode
IVMD1MODE6	1, 2, 3, 4, 5	Detection program 1 Area 6 mode
IVMD1MODE7	1, 2, 3, 4, 5	Detection program 1 Area 7 mode
IVMD1MODE8	1, 2, 3, 4, 5	Detection program 1 Area 8 mode
IVMD1AREA1	(numerical value)	Detection program 1 Area 1 Shape and coordinate of each vertex. "ABXXXXXXXXXXXXXXXXXXXXXXXXXXXX",, "A": Shape (0: Polygon, 1:Quadrangle, 2:Cross line) "B": (Number of vertex) - 1 "XXXXXXXXXX": Coordinate of each vertex at 320x240 resolution
IVMD1AREA2	(numerical value)	Detection program 1 Area 2 Shape and coordinate of each vertex.
IVMD1AREA3	(numerical value)	Detection program 1 Area 3 Shape and coordinate of each vertex.
IVMD1AREA4	(numerical value)	Detection program 1 Area 4 Shape and coordinate of each vertex.
IVMD1AREA5	(numerical value)	Detection program 1 Area 5 Shape and coordinate of each vertex.
IVMD1AREA6	(numerical value)	Detection program 1 Area 6 Shape and coordinate of each vertex.
IVMD1AREA7	(numerical value)	Detection program 1 Area 7 Shape and coordinate of each vertex.
IVMD1AREA8	(numerical value)	Detection program 1 Area 8 Shape and coordinate of each vertex.
IVMD1DIRECTION1	u, ur, r, br, b, bl, l, ul	Detection program 1 Area 1 Direction u: Up, ur: Upper right, r: Right, br: Lower right, b: Lower, bl: Lower left, l: Left, ul: Upper left

Parameter name	Value	Comments
IVMD1DIRECTION2	u, ur, r, br, b, bl, l, ul	Detection program 1 Area 2 Direction
IVMD1DIRECTION3	u, ur, r, br, b, bl, l, ul	Detection program 1 Area 3 Direction
IVMD1DIRECTION4	u, ur, r, br, b, bl, l, ul	Detection program 1 Area 4 Direction
IVMD1DIRECTION5	u, ur, r, br, b, bl, l, ul	Detection program 1 Area 5 Direction
IVMD1DIRECTION6	u, ur, r, br, b, bl, l, ul	Detection program 1 Area 6 Direction
IVMD1DIRECTION7	u, ur, r, br, b, bl, l, ul	Detection program 1 Area 7 Direction
IVMD1DIRECTION8	u, ur, r, br, b, bl, l, ul	Detection program 1 Area 8 Direction
IVMD1LINE1	1, 2, 3	Detection program 1 Area 1 Direction of Cross line 1:A→B, 2:A←B, 3 : A⇌B
IVMD1LINE2	1, 2, 3	Detection program 1 Area 2 Direction of Cross line
IVMD1LINE3	1, 2, 3	Detection program 1 Area 3 Direction of Cross line
IVMD1LINE4	1, 2, 3	Detection program 1 Area 4 Direction of Cross line
IVMD1LINE5	1, 2, 3	Detection program 1 Area 5 Direction of Cross line
IVMD1LINE6	1, 2, 3	Detection program 1 Area 6 Direction of Cross line
IVMD1LINE7	1, 2, 3	Detection program 1 Area 7 Direction of Cross line
IVMD1LINE8	1, 2, 3	Detection program 1 Area 8 Direction of Cross line
IVMD2TITLE	Characters	Detection program 2 title
IVMD2STATUS1	0, 1	Detection program 2 Area 1 Status 0: Off, 1:On
IVMD2STATUS2	0, 1	Detection program 2 Area 2 Status
IVMD2STATUS3	0, 1	Detection program 2 Area 3 Status
IVMD2STATUS4	0, 1	Detection program 2 Area 4 Status
IVMD2STATUS5	0, 1	Detection program 2 Area 5 Status
IVMD2STATUS6	0, 1	Detection program 2 Area 6 Status
IVMD2STATUS7	0, 1	Detection program 2 Area 7 Status
IVMD2STATUS8	0, 1	Detection program 2 Area 8 Status
IVMD2MODE1	1, 2, 3, 4, 5	Detection program 2 Area 1 mode
IVMD2MODE2	1, 2, 3, 4, 5	Detection program 2 Area 2 mode
IVMD2MODE3	1, 2, 3, 4, 5	Detection program 2 Area 3 mode
IVMD2MODE4	1, 2, 3, 4, 5	Detection program 2 Area 4 mode
IVMD2MODE5	1, 2, 3, 4, 5	Detection program 2 Area 5 mode
IVMD2MODE6	1, 2, 3, 4, 5	Detection program 2 Area 6 mode
IVMD2MODE7	1, 2, 3, 4, 5	Detection program 2 Area 7 mode
IVMD2MODE8	1, 2, 3, 4, 5	Detection program 2 Area 8 mode
IVMD2AREA1	(numerical value)	Detection program 2 Area 1 Shape and coordinate of each vertex
IVMD2AREA2	(numerical value)	Detection program 2 Area 2 Shape and coordinate of each vertex.
IVMD2AREA3	(numerical value)	Detection program 2 Area 3 Shape and coordinate of each vertex.
IVMD2AREA4	(numerical value)	Detection program 2 Area 4 Shape and coordinate of each vertex.
IVMD2AREA5	(numerical value)	Detection program 2 Area 5 Shape and coordinate of each vertex.
IVMD2AREA6	(numerical value)	Detection program 2 Area 6 Shape and coordinate of each vertex.
IVMD2AREA7	(numerical value)	Detection program 2 Area 7 Shape and coordinate of each vertex.
IVMD2AREA8	(numerical value)	Detection program 2 Area 8 Shape and coordinate of each vertex.

Parameter name	Value	Comments
IVMD2DIRECTION1	u, ur, r, br, b, bl, l, ul	Detection program 2 Area 1 Direction
IVMD2DIRECTION2	u, ur, r, br, b, bl, l, ul	Detection program 2 Area 2 Direction
IVMD2DIRECTION3	u, ur, r, br, b, bl, l, ul	Detection program 2 Area 3 Direction
IVMD2DIRECTION4	u, ur, r, br, b, bl, l, ul	Detection program 2 Area 4 Direction
IVMD2DIRECTION5	u, ur, r, br, b, bl, l, ul	Detection program 2 Area 5 Direction
IVMD2DIRECTION6	u, ur, r, br, b, bl, l, ul	Detection program 2 Area 6 Direction
IVMD2DIRECTION7	u, ur, r, br, b, bl, l, ul	Detection program 2 Area 7 Direction
IVMD2DIRECTION8	u, ur, r, br, b, bl, l, ul	Detection program 2 Area 8 Direction
IVMD2LINE1	1, 2, 3	Detection program 2 Area 1 Direction of Cross line 1:A→B, 2:A←B, 3: A↔B
IVMD2LINE2	1, 2, 3	Detection program 2 Area 2 Direction of Cross line
IVMD2LINE3	1, 2, 3	Detection program 2 Area 3 Direction of Cross line
IVMD2LINE4	1, 2, 3	Detection program 2 Area 4 Direction of Cross line
IVMD2LINE5	1, 2, 3	Detection program 2 Area 5 Direction of Cross line
IVMD2LINE6	1, 2, 3	Detection program 2 Area 6 Direction of Cross line
IVMD2LINE7	1, 2, 3	Detection program 2 Area 7 Direction of Cross line
IVMD2LINE8	1, 2, 3	Detection program 2 Area 8 Direction of Cross line

7.4. Audio detection setup

[Important]

To use the audio alarm detection function, set the "Audio mode setup" to 'Mic input' or 'Interactive (full duplex)'. "Audio sensitivity" also can be set. (Refer to chapter 4.5).

*) If changing the Audio sensitivity setting, the volume of the audio transmission would be changed either.

[URL] [/cgi-bin/audio_alarm? \[<Parameter name>=<Value>\]](#)

[Method] GET/POST

[Access level] 1

Parameter name	Value	Comments	Parameter to get current setting (/cgi-bin/getdata)
alarm	0, 1	Audio detection On/ Off 0: Off 1: On	AAUDIO
level	0 to 9	Audio detection level 0 (Small) to 9(Large)	AAUDIOTH

[Command examples]

Set "Audio detection alarm" to 'On', and set the level to '5'.

http://192.168.0.10/cgi-bin/audio_alarm?alarm=1&level=5

7.5. Command alarm setup

Command alarm mean the alarm(TCP alarm (Panasonic Alarm protocol), refer to chapter 7.11) from other camera or devices.

[URL] [/cgi-bin/jpeg_alarm? \[<Parameter name>=<Value>\]](#)

[Method] POST

[Access level] 1

Parameter name	Value	Comments	Parameter to get current setting (/cgi-bin/getdata)
cmd_alarm	0, 1	Command alarm ON/OFF 0: OFF (not use command alarm) 1: ON (use command alarm)	ACMD
cmd_rcvport	1 to 65535	The port number to be used receive a command alarm(Originating port number)	ACMDPORT

The camera which is enabled command alarm will make alarm when it receives the following CGI.

<http://192.168.0.10/cgi-bin/Set?Func=SoftTrigger>

7.6. Auto tracking alarm setup

Refer to chapter 6.8.2

7.7. Vehicle incident detection setup

To activate this feature, you need to install the WV-XAE100 software to the camera.

For details, refer to the Operating Instructions of WV-XAE100.

The result data can be acquired as additional information with H.264/H.265 and JPEG stream and so on.

(Refer to chapter 13)

7.7.1. Detection type setup

[URL] [/cgi-bin/jpeg_alarm?vmd_func=<Value>](#)

[Method] GET/POST

[Access level] 1

Parameter name	Value	Comments	Parameter to get current setting (/cgi-bin/getdata)
vmd_func	0, 1	VMD function type 0: VMD 1: i-VMD 2: Vehicle Incident Detection	AVMDFUNCTYPE

[Command examples]

Set the detection type to Vehicle Incident Detection.

http://192.168.0.10/cgi-bin/jpeg_alarm?vmd_func=2

7.7.2. Auto measurement of the installation height of the camera

[URL] [/cgi-bin/set_height_auto?start=1](#)

[Method] GET

[Access level] 1

[Command examples]

Start the auto measurement

http://192.168.0.10/cgi-bin/set_height_auto?start=1

7.7.3. Vehicle lane and area setup

[URL] /cgi-bin/ set_vehicle_area[?<Parameter name>=<Value>]
 [Method] GET/POST
 [Access level] 1

Parameter name	Value	Comments		Parameter to get current setting (/cgi-bin/getdata)
Lane 1 setup				
lane1_lx1	0 - 639	line 1	Left end of X coordinate	LANE1_LX1
lane1_rx1	0 - 639		Right end of X coordinate	LANE1_RX1
lane1_y1	0 - 479		Y coordinate	LANE1_Y1
lane1_lx2	0 - 639	line 2	Left end of X.	LANE1_LX2
lane1_rx2	0 - 639		Right end of X	LANE1_RX2
lane1_y2	0 - 479		Y	LANE1_Y2
lane1_lx3	0 - 639	line 3	Left end of X.	LANE1_LX3
lane1_rx3	0 - 639		Right end of X	LANE1_RX3
lane1_y3	0 - 479		Y	LANE1_Y3
lane1_lx4	0 - 639	line 4	Left end of X.	LANE1_LX4
lane1_rx4	0 - 639		Right end of X	LANE1_RX4
lane1_y4	0 - 479		Y	LANE1_Y4
lane1_lx5	0 - 639	line 5	Left end of X.	LANE1_LX5
lane1_rx5	0 - 639		Right end of X	LANE1_RX5
lane1_y5	0 - 479		Y	LANE1_Y5
lane1_reverse	enable, disable	Detect the Wrong-way vehicle		LANE1_REVERSE
lane1_stop	enable, disable	Detect the Stopped vehicle		LANE1_STOP
lane1_direction	forward, backward, right, left	Moving direction		LANE1_DIRECTION
Lane 2 setup				
lane2_lx1	0 - 639	line 1	Left end of X coordinate	LANE2_LX1
lane2_rx1	0 - 639		Right end of X coordinate	LANE2_RX1
lane2_y1	0 - 479		Y coordinate	LANE2_Y1
lane2_lx2	0 - 639	line 2	Left end of X.	LANE2_LX2
lane2_rx2	0 - 639		Right end of X	LANE2_RX2

Parameter name	Value	Comments		Parameter to get current setting (/cgi-bin/getdata)
lane2_y2	0 - 479		Y	LANE2_Y2
lane2_lx3	0 - 639	line 3	Left end of X.	LANE2_LX3
lane2_rx3	0 - 639		Right end of X	LANE2_RX3
lane2_y3	0 - 479		Y	LANE2_Y3
lane2_lx4	0 - 639	line 4	Left end of X.	LANE2_LX4
lane2_rx4	0 - 639		Right end of X	LANE2_RX4
lane2_y4	0 - 479		Y	LANE2_Y4
lane2_lx5	0 - 639	line 5	Left end of X.	LANE2_LX5
lane2_rx5	0 - 639		Right end of X	LANE2_RX5
lane2_y5	0 - 479		Y	LANE2_Y5
lane2_reverse	enable, disable	Detect the Wrong-way vehicle		LANE2_REVERSE
lane2_stop	enable, disable	Detect the Stopped vehicle		LANE2_STOP
lane2_direction	forward, backward, right, left	Moving direction		LANE2_DIRECTION
Lane 3 setup				
lane3_lx1	0 - 639	line 1	Left end of X coordinate	LANE3_LX1
lane3_rx1	0 - 639		Right end of X coordinate	LANE3_RX1
lane3_y1	0 - 479		Y coordinate	LANE3_Y1
lane3_lx2	0 - 639	line 2	Left end of X.	LANE3_LX2
lane3_rx2	0 - 639		Right end of X	LANE3_RX2
lane3_y2	0 - 479		Y	LANE3_Y2
lane3_lx3	0 - 639	line 3	Left end of X.	LANE3_LX3
lane3_rx3	0 - 639		Right end of X	LANE3_RX3
lane3_y3	0 - 479		Y	LANE3_Y3
lane3_lx4	0 - 639	line 4	Left end of X.	LANE3_LX4
lane3_rx4	0 - 639		Right end of X	LANE3_RX4
lane3_y4	0 - 479		Y	LANE3_Y4
lane3_lx5	0 - 639	line 5	Left end of X.	LANE3_LX5
lane3_rx5	0 - 639		Right end of X	LANE3_RX5
lane3_y5	0 - 479		Y	LANE3_Y5
lane3_reverse	enable, disable	Detect the Wrong-way vehicle		LANE3_REVERSE
lane3_stop	enable, disable	Detect the Stopped vehicle		LANE3_STOP

Parameter name	Value	Comments	Parameter to get current setting (/cgi-bin/getdata)	
lane3_direction	forward, backward, right, left	Moving direction	LANE3_DIRECTION	
Lane 4 setup				
lane4_lx1	0 - 639	line 1	Left end of X coordinate	LANE4_LX1
lane4_rx1	0 - 639		Right end of X coordinate	LANE4_RX1
lane4_y1	0 - 479		Y coordinate	LANE4_Y1
lane4_lx2	0 - 639	line 2	Left end of X.	LANE4_LX2
lane4_rx2	0 - 639		Right end of X	LANE4_RX2
lane4_y2	0 - 479		Y	LANE4_Y2
lane4_lx3	0 - 639	line 3	Left end of X.	LANE4_LX3
lane4_rx3	0 - 639		Right end of X	LANE4_RX3
lane4_y3	0 - 479		Y	LANE4_Y3
lane4_lx4	0 - 639	line 4	Left end of X.	LANE4_LX4
lane4_rx4	0 - 639		Right end of X	LANE4_RX4
lane4_y4	0 - 479		Y	LANE4_Y4
lane4_lx5	0 - 639	line 5	Left end of X.	LANE4_LX5
lane4_rx5	0 - 639		Right end of X	LANE4_RX5
lane4_y5	0 - 479		Y	LANE4_Y5
lane4_reverse	enable, disable	Detect the Wrong-way vehicle	LANE4_REVERSE	
lane4_stop	enable, disable	Detect the Stopped vehicle	LANE4_STOP	
lane4_direction	forward, backward, right, left	Moving direction	LANE4_DIRECTION	
Common setup				
stop_time	5 - 15	Detection time of Stopped Vehicle 5 - 15 sec.	STOP_TIME	
night_mode	monitor, detect	Night mode monitor : Priority to monitoring detect : Priority to Detection	NIGHT_MODE	
preno	1 - 256	Preset position number	-	

7.8. Alarm mask setup

[URL] [/cgi-bin/jpeg_alarm?mask_time=<Value>](#)

[Method] POST

[Access level] 1

Value	Comments	Parameter to get current setting (/cgi-bin/getdata)
5 to 600	Time off the alarm mask period 5 to 600 second	MASKTIME

[Command examples]

Change alarm mask period to 20 second.

http://192.168.0.10/cgi-bin/jpeg_alarm?mask_time=20

7.9. Camera action on Alarm

7.9.1. PTZ action on alarm

[URL] /cgi-bin/almsetup?[<Parameter name>=<Value>]

[Method] POST

[Access level] 1

Parameter name	Value	Comments	Parameter to get current setting (/cgi-bin/getdata)
almpreset1	off, 1 to 256, attrack, patrol1	Set an action to be taken when a terminal alarm 1 is detected off : OFF 1 to 256 : Move to Preset position attrack : Start the auto track patrol1 : Start the patrol 1 operation	-
almpreset2	off, 1 to 256, attrack, patrol2	Set an action to be taken when a terminal alarm 2 is detected off : OFF 1 to 256 : Move to Preset position attrack : Start the auto track patrol2 : Start the patrol 2 operation	-
almpreset3	off, 1 to 256, attrack, patrol3	Set an action to be taken when a terminal alarm 3 is detected off : OFF 1 to 256 : Move to Preset position attrack : Start the auto track patrol3 : Start the patrol 3 operation	-
vmd_preset	off, 1 to 256, attrack, patrol1	Set an action to be taken when a VMD alarm is detected. off : OFF 1 to 256 : Move to Preset position attrack : Start the auto track patrol1 : Start the patrol 1 operation	-
cmd_preset	off, 1 to 256, attrack, patrol1 srcaddr	Set an action to be taken when a command alarm is detected off : OFF 1 to 256 : Move to Preset position attrack : Start the auto track patrol1 : Start the patrol 1 operation srcaddr : Preset per sender	-
audio_preset	off, 1 to 256, attrack, patrol1	Set an action to be taken when an audio alarm is detected off : OFF 1 to 256 : Move to Preset position attrack : Start the auto track patrol1 : Start the patrol 1 operation	-

[Command example]

Set terminal alarm 1: attrack

<http://192.168.0.10/cgi-bin/almsetup?almpreset1=attrack>

7.9.2. JPEG compression rate upon alarm detection

[URL] /cgi-bin/jpeg_alarm? [<Parameter name>=<Value>]

[Method] POST

[Access level] 1

Parameter name	Value	Comments	Parameter to get current setting (/cgi-bin/getdata)
image_control	0, 1	Change image compression rate upon alarm detection. 1 : On (Use this function) 0 : Off(Does not use this function)	ALMIMGCNT
image_quality	0, 1, 2, 3, 4, 5, 6, 7, 8, 9	Image quality upon alarm detection 0 :means superfine, 1 :means fine, 2, 3, 4, 5 :means normal, 6, 7, 8, 9 :means low	ALMIMGQUAL

7.9.3. E-mail notification

Refer to chapter 11.7.2

7.9.4. Image FTP transmission

Refer to chapter 11.5.2

7.9.5. TCP alarm (Panasonic alarm protocol) setup

7.9.5.1. Notification setup

[URL] /cgi-bin/pana_alm? [<Parameter name>=<Value>]

[Method] POST

[Access level] 1

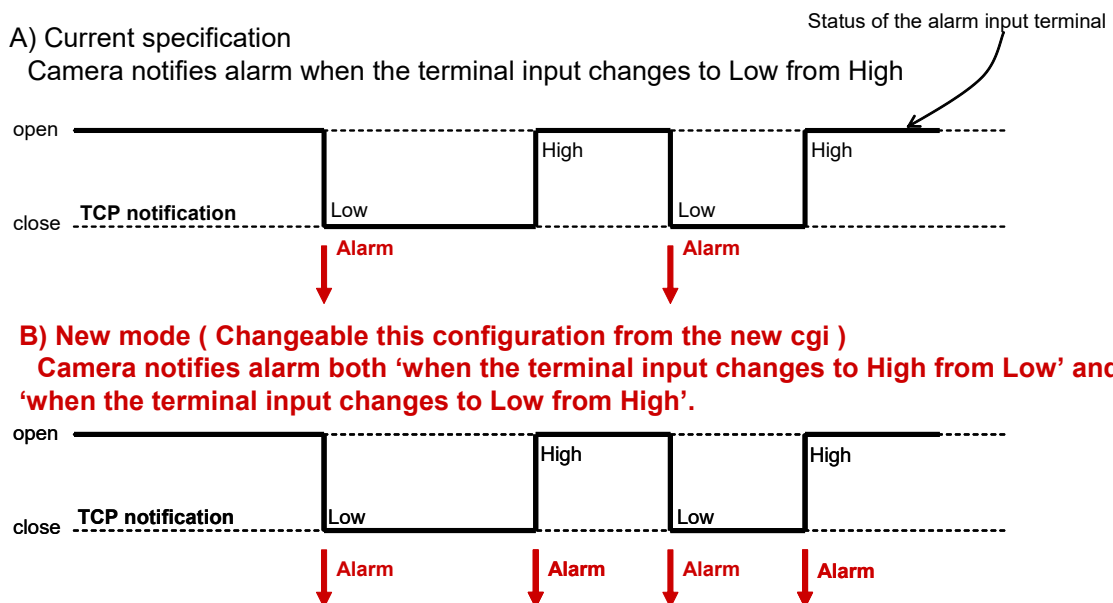
Parameter name	Value	Comments	Parameter to get current setting (/cgi-bin/getdata)
pana_alm	0, 1, 96	Alarm Whether or not be send notification. 0: OFF 1: ON (Notification only 'when the terminal input changes to Low from High'.) >> figure A) in the following page. 96: ON (Notification both 'when the terminal alarm input changes to High from Low' and 'when the terminal input changes to Low from High') >> figure B) in the following page.	ORGUSE
pana_almext	0, 1	Determine whether or not to send notifications with additional alarm data 0 : OFF, 1 : ON refer to chapter 7.11	ORGEEXT
pana_port	1 to 65535	Destination port number	ORGPORT
pana_retry	1 to 30	Retry times	ORGRTRY

[Command examples]

Change TCP alarm(Panasonic alarm) setup, alarm notification: ON, destination port: 10080, retry times: 2, alarm notification extension: ON

http://192.168.0.10/cgi-bin/pana_alm?pana_alm=1&pana_port=10080&pana_retry=2&pana_almext=1

In case of Normally open



7.9.5.2. Destination IP address setup

[URL] /cgi-bin reg_addr?[<Parametername>=<Value>]

[Method] POST

[Access level] 1

Parameter name	Value	Comments	Parameter to get current setting (/cgi-bin/getdata)
notice1_addr	<IPv4or IPv6 address>	Destination IP address 1	ORGADD1
notice2_addr	<IPv4or IPv6 address>	Destination IP address 2	ORGADD2
notice3_addr	<IPv4or IPv6 address>	Destination IP address 3	ORGADD3
notice4_addr	<IPv4or IPv6 address>	Destination IP address 4	ORGADD4
notice5_addr	<IPv4or IPv6 address>	Destination IP address 5	ORGADD5
notice6_addr	<IPv4or IPv6 address>	Destination IP address 6	ORGADD6
notice7_addr	<IPv4or IPv6 address>	Destination IP address 7	ORGADD7
notice8_addr	<IPv4or IPv6 address>	Destination IP address 8	ORGADD8
notice1_onoff	0, 1	To perform notification to "destination IP address 1" 0: OFF, 1: ON	ORGALM1
notice2_onoff	0, 1	To perform notification to "destination IP address 2"	ORGALM2
notice3_onoff	0, 1	To perform notification to "destination IP address 3"	ORGALM3
notice4_onoff	0, 1	To perform notification to "destination IP address 4"	ORGALM4
notice5_onoff	0, 1	To perform notification to "destination IP address 5"	ORGALM5
notice6_onoff	0, 1	To perform notification to "destination IP address 6"	ORGALM6
notice7_onoff	0, 1	To perform notification to "destination IP address 7"	ORGALM7
notice8_onoff	0, 1	To perform notification to "destination IP address 8"	ORGALM8
notice1_self_onoff	0, 1	To perform the notification about SD card information to "destination IP address 1". 0: OFF, 1: ON	ORGNOTICE1
notice2_self_onoff	0, 1	To perform the notification about SD card information to "destination IP address 2".	ORGNOTICE2
notice3_self_onoff	0, 1	To perform the notification about SD card information to "destination IP address 3".	ORGNOTICE3
notice4_self_onoff	0, 1	To perform the notification about SD card information to "destination IP address 4".	ORGNOTICE4
notice5_self_onoff	0, 1	To perform the notification about SD card information to "destination IP address 5".	ORGNOTICE5

Parameter name	Value	Comments	Parameter to get current setting (/cgi-bin/getdata)
notice6_self_onoff	0, 1	To perform the notification about SD card information to "destination IP address 6".	ORGNOTICE6
notice7_self_onoff	0, 1	To perform the notification about SD card information to "destination IP address 7".	ORGNOTICE7
notice8_self_onoff	0, 1	To perform the notification about SD card information to "destination IP address 8".	ORGNOTICE8
notice1_vmd_onoff	0, 1	Notification per VMD area (Destination address 1) 0: Off (All area) 1: On (Per VMD area) Default value: 0	ORGVMD1
notice1_areano	1, 2, 3, 4	VMD alarm area No. (Destination address 1) 1: VMD area 1 2: VMD area 2 3: VMD area 3 4: VMD area 4 Default value: 1	ORGVMDAREA1
notice2_vmd_onoff	0, 1	Notification per VMD area (Destination address 2)	ORGVMD2
notice2_areano	1, 2, 3, 4	VMD alarm area No. (Destination address 2)	ORGVMDAREA2
notice3_vmd_onoff	0, 1	Notification per VMD area (Destination address 3)	ORGVMD3
notice3_areano	1, 2, 3, 4	VMD alarm area No. (Destination address 3)	ORGVMDAREA3
notice4_vmd_onoff	0, 1	Notification per VMD area (Destination address 4)	ORGVMD4
notice4_areano	1, 2, 3, 4	VMD alarm area No. (Destination address 4)	ORGVMDAREA4
notice5_vmd_onoff	0, 1	Notification per VMD area (Destination address 5)	ORGVMD5
notice5_areano	1, 2, 3, 4	VMD alarm area No. (Destination address 5)	ORGVMDAREA5
notice6_vmd_onoff	0, 1	Notification per VMD area (Destination address 6)	ORGVMD6
notice6_areano	1, 2, 3, 4	VMD alarm area No. (Destination address 6)	ORGVMDAREA6
notice7_vmd_onoff	0, 1	Notification per VMD area (Destination address 7)	ORGVMD7
notice7_areano	1, 2, 3, 4	VMD alarm area No. (Destination address 7)	ORGVMDAREA7
notice8_vmd_onoff	0, 1	Notification per VMD area (Destination address 8)	ORGVMD8
notice8_areano	1, 2, 3, 4	VMD alarm area No. (Destination address 8)	ORGVMDAREA8

[Command examples]

Set destination IP address to 192.168.0.20 and alarm notification is ON.

http://192.168.0.10/cgi-bin/reg_addr?notice1_addr=192.168.0.20¬ice1_onoff=1

[Command example]

e.g.) TCP alarm(Panasonic alarm) notification per VMD area No.2 to 192.168.0.92

http://192.168.0.10/cgi-bin/reg_addr?notice1_addr=192.168.0.92¬ice1_onoff=1¬ice1_vmd_onoff=1¬ice1_areano=2

***1 Notification per VMD area No.**

[Description]

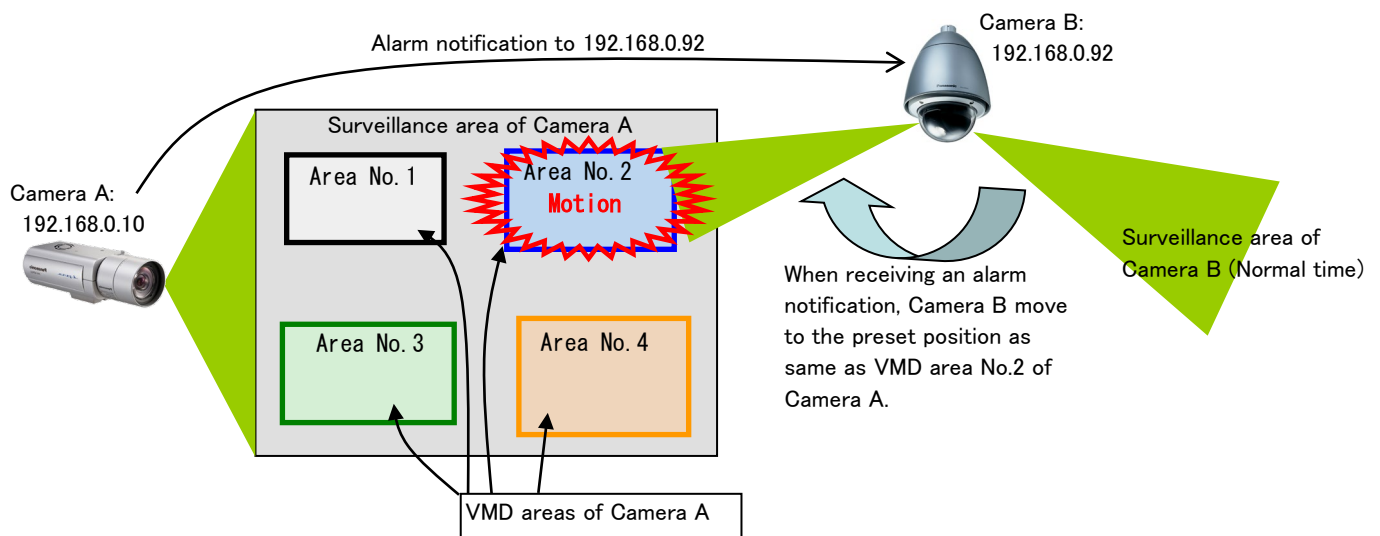
When 'Notification per VMD area' is set to 'On', the TCP alarm(Panasonic alarm protocol) notification is only implemented when the 'Alarm area No.' conforms with the VMD alarm detection number. Notification destinations for TCP alarm(Panasonic alarm protocol)notification can be configured for each alarm area number.

In accordance with the areas detected in VMD alarm, cameras can be coordinated together to perform operations such as moving the preset position by using the 'Camera action on alarm' of the PTZ cameras.

[Usage sample]

Using with PTZ camera

Preliminarily, register a preset position to the PTZ camera (Camera B) as same position as VMD area No.2 of the Camera A. And, configure the setting of 'preset motion on alarm' to Camera B (chapter7.9.1).



7.9.5.3. Delete destination IP address

[URL] /cgi-bin/del_addr?del=<Value>

[Method] GET/POST

[Access level] 1

Parameter name	Value	Comments
del	1, 2, 3, 4, 5, 6, 7, 8	Delete IP address 1: destination IP address1 2: destination IP address2 3: destination IP address3 4: destination IP address4 5: destination IP address5 6: destination IP address6 7: destination IP address7 8: destination IP address8

[Command examples]

Delete destination IP address 1

http://192.168.0.10/cgi-bin/del_addr?del=1

7.10. Notification / Get status method

7.10.1. Supported protocol and comparison

	TCP alarm (Panasonic Alarm Protocol)	HTTP Alarm Protocol	/cgi-bin/get_io	/cgi-bin/get_io2	Additional information & meta information
Chapter in this document	chapter 7.11	chapter 7.12	chapter 7.10.2, 7.10.3	chapter 7.10.4	chapter 13
Protocol	TCP (use unique port)	HTTP	HTTP (CGI) (Text response)		RTP (H.264/H.265) header or JPEG header
When does the camera notice?	When detected (PUSH)	When detected (PUSH)	- Constantly notices and notice when detected (PUSH)	- When client request (PULL)	included in video stream.
Alarm kind					
VMD	yes (area No.)	yes	yes (area No.)	yes (area No.)	yes (status for each block)
i-VMD / AI-VMD	yes (only kind)	yes (only kind)	N/A	yes (only kind)	yes (including object coordinate)
Vehicle incident detection	yes (only kind)	yes (only kind)	N/A	N/A	yes (including object coordinate)
I/O	yes	yes	yes	yes	N/A
Audio detection	yes	yes	N/A	yes	yes
SD card	yes (error, remaining capacity)	N/A	N/A	N/A	yes (recording status)
Auto tracking	yes	yes	N/A	yes	yes (including object coordinate)

7.10.2. Getting alarm terminal input status (PULL)

[URL] /cgi-bin/get_io?command=<Value>

[Method] GET

[Access level] 3

Parameter name	Value	Comments
command	alarm_in1, alarm_in2, alarm_in3, all	Get alarm input terminal status alarm_in1 :Get alarm input 1 status alarm_in2 :Get alarm input 2 status alarm_in3 :Get alarm input 3 status all :Get all of alarm input status

[Command examples]

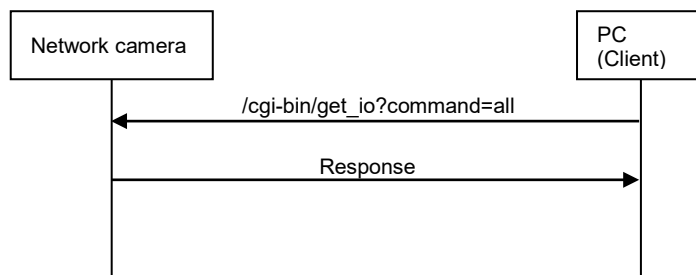
Get terminal alarm input 1 status.

http://192.168.0.10/cgi-bin/get_io?command=alarm_in1

Get terminal all alarm input status.

http://192.168.0.10/cgi-bin/get_io?command=all

[Sequence]



[Command response]

```
-----
HTTP/1.0 200 OK[CR][LF]
Content-Type: text/plain[CR][LF]
[CR][LF]
terminal 1: High[CR][LF]
terminal 2: Low[CR][LF]
terminal 3: High[CR][LF]
-----
```


[Response format]

```
--myboundary
Content-Type: text/plain
terminal1 I High
terminal2 I High
terminal3 O Low
[A]      [B]  [C]
motiondetect True
          [E]
09-01-08 11:58:12
          [D]
--myboundary
Content-Type: text/plain
```

[A]: I/O number

'terminal1' or 'terminal2' or 'terminal3'

A number of I/O depends on each products.

[B]: I/O.type (or setting)

'I' = Input port,

'O' = Output port

[C]: Status of I/O port

'High' or 'Low'

[D]: Date & time when the event was occurred (Sending message time).

Structure = 'Year' - 'Month' - 'Date' 'Hour' : 'Minute' : 'Second'

[E]: Status of VMD

'True': Detect the motion

'False': Not detect the motion

Multi-sensor models when 'ch' is omitted

motiondetect : VMD status of ch1

motiondetect_ch2 : VMD status of ch2

motiondetect_ch3 : VMD status of ch3

motiondetect_ch4 : VMD status of ch4

7.10.4. I/O and VMD status notification (New format)

7.10.4.1. CGI

[URL] [/cgi-bin/get_io2?mode=monitor&format=<Value>\[&<Parameter name>=<Value>\]](#)

[Method] GET

[Access level] 3

Parameter name	Value	Comments
mode	monitor	monitor: Get I/O and VMD status continuously * The detail information is described as below.
format	1, 2, 3	Format of status information 1: Same format as "/cgi-bin/get_io" 2: New format described as this chapter 3: New format described as this chapter(Audio detection, command alarm and i-VMD parameter are added)
interval	1 to 15	Notification interval 1 to 15sec Default: 15 sec
vmdarea	off on	Notification per VMD area off: Off on: On (Add VMD area No.) Default: off
motiondetect_ratio	off on	Motion detect ratio off: Off on: On (Add the Motion detect ratio) Default: off
ch	1,2,3,4	Channel 1 : VMD status of ch1 is replied as 'motiondetect' 2 : VMD status of ch2 is replied as 'motiondetect' 3 : VMD status of ch3 is replied as 'motiondetect' 4 : VMD status of ch4 is replied as 'motiondetect' [Note] #This parameter is supported by Multi-sensor models. When this parameter is omitted, VMD status for each channel are replied simultaneously as 'motiondetect', 'motiondetect_ch2', 'motiondetect_ch3', 'motiondetect_ch4', respectively.

[Command examples]

Start the I/O and VMD status notification with new format.

http://192.168.0.10/cgi-bin/get_io2?mode=monitor&format=2

Start the I/O and VMD status notification (Interval: 3 sec.)

http://192.168.0.10/cgi-bin/get_io2?mode=monitor&format=2&interval=3

Start the I/O and VMD status notification (Add VMD area No.)

http://192.168.0.10/cgi-bin/get_io2?mode=monitor&format=2&vmdarea=on

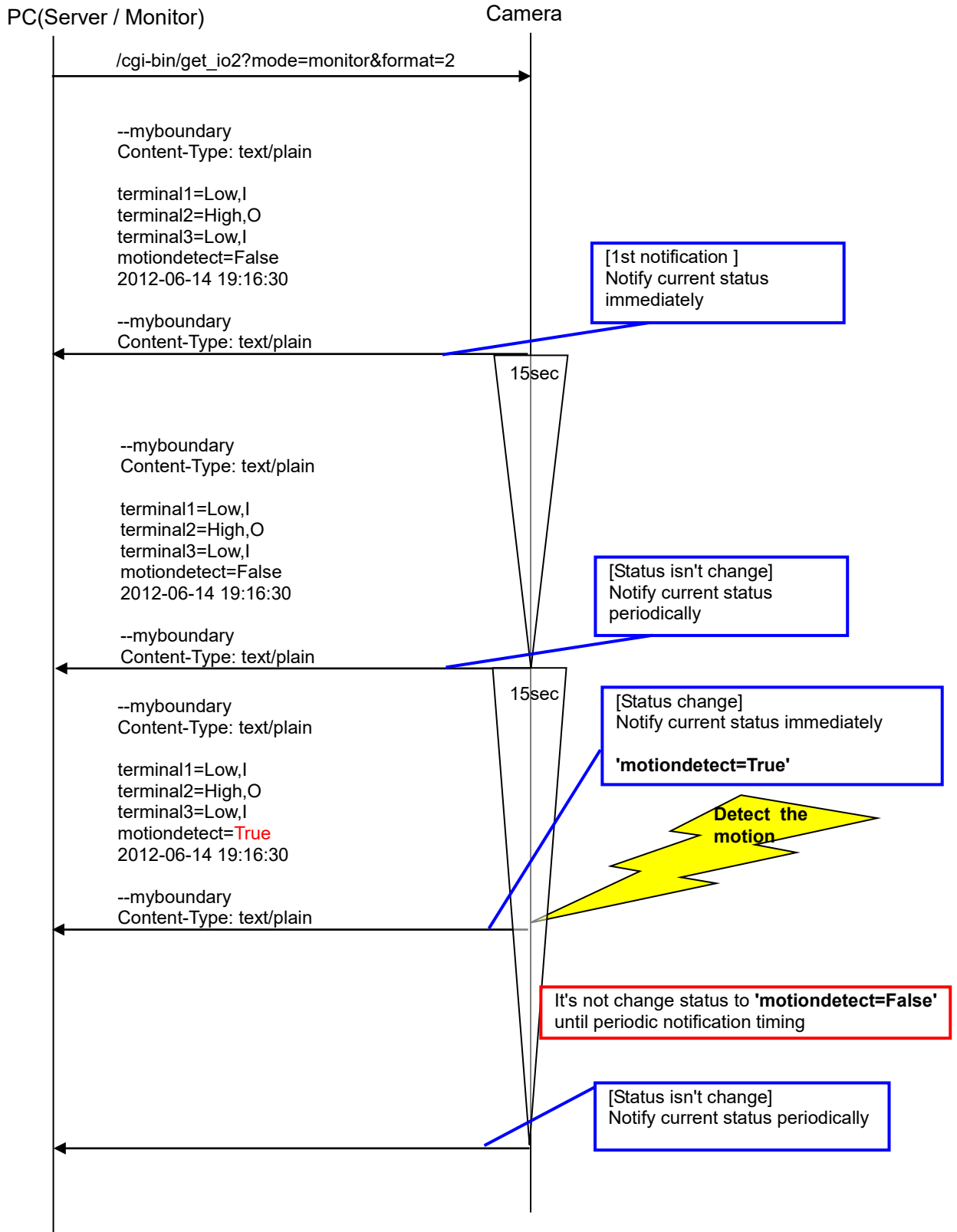
Start the I/O and VMD status notification (Add motion detect ratio)

http://192.168.0.10/cgi-bin/get_io2?mode=monitor&format=3&motiondetect_ratio=on

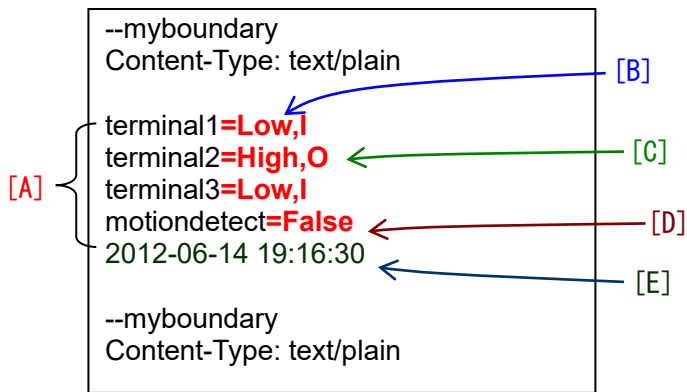
Start the I/O, VMD, Audio detection and Command alarm status notification with new format.

http://192.168.0.10/cgi-bin/get_io2?mode=monitor&format=3

7.10.4.2. Sequence



7.10.4.3. Response format (when format=2)



[A]: Title (I/O number, motiondetect)
 'terminal1' or 'terminal2' or 'terminal3' or 'motiondetect'
 terminal1: Terminal 1
 terminal2: Terminal 2
 terminal3: Terminal 3
 motiondetect: VMD (*1)
 motiondetect_ch2 : VMD of ch2 (for Multi-sensor models when 'ch' is omitted)
 motiondetect_ch3 : VMD of ch3 (for Multi-sensor models when 'ch' is omitted)
 motiondetect_ch4 : VMD of ch4 (for Multi-sensor models when 'ch' is omitted)
 # A number of I/O depends on each products.

[B]: Status of I/O port
 'High' or 'Low'

[C]: I/O.type (or setting)
 'I' = Input port, 'O' = Output port

[D]: Status of VMD
 'True': Detect the motion, 'False': Not detect the motion

[E]: Date & time when the event was occurred (Sending message time).
 Structure = 'Year' - 'Month' - 'Date' 'Hour' : 'Minute' : 'Second'

(*1) When adding the parameter "vmdarea=on", following parameters are added in the response.

- vmdarea1: VMD area No1
- vmdarea2: VMD area No2
- vmdarea3: VMD area No3
- vmdarea4: VMD area No4
- vmdarea1_ch2 : VMD area No1 of ch2 (for Multi-sensor models when 'ch' is omitted)
- vmdarea2_ch2 : VMD area No2 of ch2 (for Multi-sensor models when 'ch' is omitted)
- vmdarea3_ch2 : VMD area No3 of ch2 (for Multi-sensor models when 'ch' is omitted)
- vmdarea4_ch2 : VMD area No4 of ch2 (for Multi-sensor models when 'ch' is omitted)
- vmdarea1_ch3 : VMD area No1 of ch3 (for Multi-sensor models when 'ch' is omitted)
- vmdarea2_ch3 : VMD area No2 of ch3 (for Multi-sensor models when 'ch' is omitted)
- vmdarea3_ch3 : VMD area No3 of ch3 (for Multi-sensor models when 'ch' is omitted)
- vmdarea4_ch3 : VMD area No4 of ch3 (for Multi-sensor models when 'ch' is omitted)
- vmdarea1_ch4 : VMD area No1 of ch4 (for Multi-sensor models when 'ch' is omitted)
- vmdarea2_ch4 : VMD area No2 of ch4 (for Multi-sensor models when 'ch' is omitted)
- vmdarea3_ch4 : VMD area No3 of ch4 (for Multi-sensor models when 'ch' is omitted)
- vmdarea4_ch4 : VMD area No4 of ch4 (for Multi-sensor models when 'ch' is omitted)

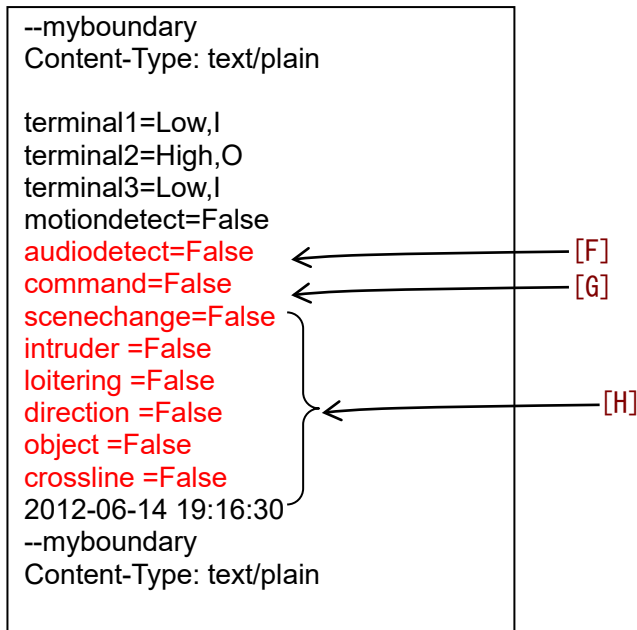
* The model which supports Auto tracking function.
 autotrack=False or autotrack=True
 'True' : Auto tracking, 'False': Not auto tracking

*When adding the parameter "Motion detect ratio", the following parameters are added in the response.

 motiondetect_ratio= (numerical value)

#It is responded the ratio of the detected motion (unit: % by an integer value) in an angle of the view of a camera.

7.10.4.4. Response format ([when format=3](#))



[F]: Status of Audio detection

'True': Detect, 'False': Not detect

'None': Off is set for audio detection or not supported model

[G]: Status of command alarm

'True': Detect, 'False': Not detect

'None': Off is set for command alarm or not supported model

[H] i-VMD / AI-VMD alarm

***These parameter will be appeared when extension software for i-VMD / AI-VMD is installed.**

scenechange: Status of scene change detection

'True': Detect 'False': Not detect

intruder: Status of intruder detection

'True': Detect 'False': Not detect

loitering: Status of loitering detection

'True': Detect 'False': Not detect

direction: Status of direction detection

'True': Detect 'False': Not detect

object: Status of object detection

'True': Detect 'False': Not detect

crossline : Status of cross line detection

'True': Detect 'False': Not detect

[I] AI-VMD information

*When detecting by AI-VMD, the detection mode and the detection objects are displayed.

alarm_object=FALSE : Not detect

alarm_object=INTRUDER ALARM HUMAN : INTRUDER (humans)

alarm_object=INTRUDER ALARM VEHICLE : INTRUDER (vehicles)

alarm_object=INTRUDER ALARM BICYLCLE : INTRUDER (bicycles)

alarm_object=LOITERING ALARM HUMAN : LOITERING (humans)

alarm_object=LOITERING ALARM VEHICLE : LOITERING (vehicles)

alarm_object=LOITERING ALARM BICYLCLE : LOITERING (bicycles)

alarm_object=DIRECTION ALARM HUMAN : DIRECTION (humans)
alarm_object=DIRECTION ALARM VEHICLE : DIRECTION (vehicles)
alarm_object=DIRECTION ALARM BICYLCLE : DIRECTION (bicycles)
alarm_object=CROSS LINE ALARM HUMAN : CROSS LINE (humans)
alarm_object=CROSS LINE ALARM VEHICLE : CROSS LINE (vehicles)
alarm_object=CROSS LINE ALARM BICYLCLE : CROSS LINE (bicycles)

[J] Audio detection

*It is displayed only in the supported model for AI Audio detection.

audio_classification=AUDIO ALARM GUNSHOT: Detection of gunshot

audio_classification=AUDIO ALARM YELL : Detection of yell

audio_classification=AUDIO ALARM VEHICLE HORN : Detection of Vehicle horn

audio_classification=AUDIO ALARM GLASS BREAK : Detection of Glass break

audio_classification=AUDIO ALARM : Detection Except for Gunshot / Yell / Vehicle horn / Glass break

7.10.4.5. Capability information

Whether the camera supports 'format=3' can be acquired by the get_capability cgi.

[video_server.alarm.get_io2.format=1,2,3](#)

*If this line doesn't exist in get_capability response, the camera does not support.

7.11. TCP alarm(Panasonic Alarm Protocol)

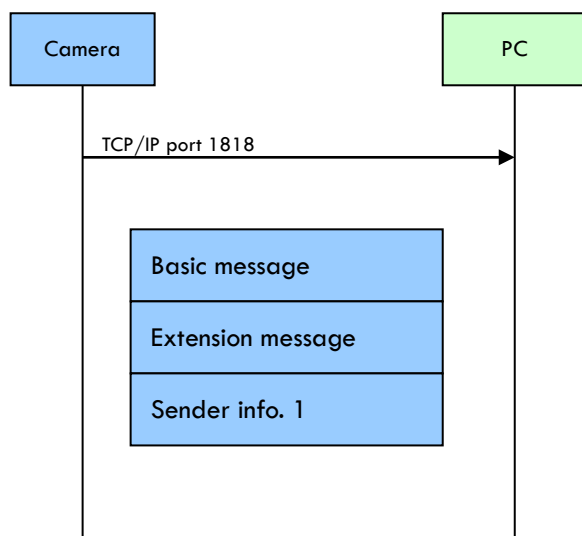
7.11.1. Preface

The specification of the TCP alarm(Panasonic Alarm Protocol) is described in this chapter. Alarm or error commands generated from cameras are sent to external devices, such as PC or i-PRO network disk recorders with TCP/IP port 1818 (which is changeable according to setup)

7.11.2. Message contents

7.11.2.1. Sequence

Message format can send “extension message” and “sender information 1” along with “basic message” to external system. Extension area for alarm messages is sent when determining additional alarm data is added (refer to chapter 7.9.5.1).



7.11.2.2. Message format

Message is made of the data size below and basic message, extension message and sender information accordingly

Message area definition and allocated data size

Area	Size [Byte]	Parameters or reference
Basic message	20	
Extension message	Variable length	Extension message identifier = 0x0001 (*) Additional message area. Alarm or error info. are in this area.
Sender info	24	Identifier info = 0x0002 (IPv4, IPv6) (*) Sender info (MAC address, time stamp etc.) of device, which create this info, are added on existing sender info Additional sender info is located right after previous sender info

(*) Identifier

Value	Table content	Reference
0x0000	Backup area	Backup
0x0001	Extension message area	
0x0002	Sender info area	For IPv4
0x0003 to 0xFFFF	Back up area	Back up

7.11.2.3. Table contents

Basic area table contents

	Item	Size	Value	Reference
Basic message area	Sender IP address (IPv4)	2Word	IP address	IP address (IPv4) of sender device NULL is assigned when device utilizes IPv6 Byte order is big endian
	Log No.	1Word	1 to 0xFFFF	Sender device has this number When 1 to 0xFFFF reach, it will start from 1 again
	Year (BCD)	1Byte	0x00 to 0x99	Sender time information
	Month (BCD)	1Byte	0x01 to 0x12	
	Day (BCD)	1Byte	0x01 to 0x31	
	Hour (BCD)	1Byte	0x00 to 0x23	
	Minute (BCD)	1Byte	0x00 to 0x59	
	Second (BCD)	1Byte	0x00 to 0x59	
	Alarm content	1Byte	0x00 to 0xFF	First 3bit : alarm contents (*1) Rest of 5bit : alarm terminal # (*2) 0x43 : Intruder detection, Loitering detection, Direction detection, Object detection, Cross line, Vehicle Incident Detection 0x83 : Scene change detection
	Camera No.	1Byte	0x00 to 0xFF	- Camera : 0x01 - Camera without camera # : 0x00 - Device which can handle multiple cameras (encoder etc.) : Number of camera *Multi-sensor models 0x01(ch1),0x02(ch2),0x03(ch3),0x04(ch4)
	Padding	1Byte	0x00	0x00 : Alarm notification which is generated from a parts other than Extension Software 0x01 : Alarm notification which is generated from Extension Software
	Extension message area flag	1Byte	0x00 0x80	0x00 : No extension message area 0x80 : Extension message exists
	Flag for saving pictures	1Byte	0x00	0x00
	# of picture	1Byte	0x00	0x00 Specified # in camera config (1 to 40)
Frame rate	1Byte	0x00	0x00	
Pre pictures in memory	1Byte	0x00 to 0xFF	0x00 Specified # in camera config (0 to 20)	

(*1)Alarm contents

bit7	bit6	bit5	Alarm contents
0	0	0	Information notification
0	0	1	Detect alarm terminal (TRM) # To Low from High
0	1	0	Detect camera VMD alarm
0	1	1	Detect camera command alarm
1	0	0	Detect camera scene change detection alarm
1	0	1	Detect alarm terminal (TRM) # To High from Low
1	1	0	Sound Detect
1	1	1	Detect encoder alarm (Detailed alarm contents are added on extension area)

(*2)Alarm terminal #

Bit4	Bit3	Bit2	Bit1	Bit0	Alarm terminal #
0	0	0	0	0	Back up
0	0	0	0	1	1CH
0	0	0	1	0	2CH
0	0	0	1	1	3CH
0	0	1	0	0	4CH
0	0	1	0	1	5CH
0	0	1	1	0	6CH
0	0	1	1	1	7Ch
0	1	0	0	0	8CH
0	1	0	0	1	Back up
.					Back up
.					
.					
.					
1	1	1	1	1	Back up

Extension message area

Table contents		Size	Value	Reference
Extension message area	Identifier	2 Byte	0x0001	Fixed area
	Size	2 Byte		Size of extension message size including header info Maximum 512 byte (*1)
	Category	1 Byte	0x00 to 0xFF	Identify camera or encoder 0x01 camera 0x03 encoder
	Message ID	1 Byte	0x00 to 0xFF	Message ID defined by each product category
	Padding	2 Byte	0x0000	
	Extension area	Variable	ASCII	Refer described below

Extension area table contents (Category=0x01)

Message name	Extension area			Remarks
	Category	Message ID	Message (ASCII) *1	
SD-MEMORY FULL	0x01	0x01	SD-MEMORY FULL	Alarm table contents (What kind of alarms happened in camera) in basic message area are first 3 bits : 000b
SD-MEMORY NOT DETECTED	0x01	0x02	SD-MEMORY NOT DETECTED	
SD-MEMORY CAPACITY **%	0x01	0x03	SD-MEMORY CAPACITY **%	
TERMINAL ALARM (Quad stream mode)	0x01	0x20	TERMINAL ALARM **ch	This message is used by the Quad stream mode of Fisheye models.
COMMAND ALARM (Quad stream mode)	0x01	0x22	COMMAND ALARM 01ch	This message is used by the Quad stream mode of Fisheye models.
VMD ALARM (Quad stream mode)	0x01	0x2F	VMD ALARM **ch	This message is used by the Quad stream mode of Fisheye models.
AUTO TRACK ALARM	0x01	0x31	AUTO TRACK ALARM	Alarm table contents (What kind of alarms happened in camera) in basic message area become 0x42.
INTRUDER ALARM	0x01	0x32	(WV-SAE200W) INTRUDER ALARM (WV-XAE200W) INTRUDER ALARM HUMAN INTRUDER ALARM VEHICLE INTRUDER ALARM BICYCLE	Alarm table contents (What kind of alarms happened in camera) in basic message area become is 0x43.
LOITERING ALARM	0x01	0x33	(WV-SAE200W) LOITERING ALARM (WV-XAE200W) LOITERING ALARM HUMAN LOITERING ALARM VEHICLE LOITERING ALARM BICYCLE	
DIRECTION ALARM	0x01	0x34	(WV-SAE200W) DIRECTION ALARM (WV-XAE200W) DIRECTION ALARM HUMAN DIRECTION ALARM VEHICLE DIRECTION ALARM BICYCLE	
OBJECT ALARM	0x01	0x35	OBJECT ALARM	
SCENE CHANGE ALARM	0x01	0x36	SCENE CHANGE ALARM	Alarm table contents (What kind of alarms happened in camera) in basic message area become is 0x83.
AUDIO DETECTION ALARM	0x01	0x37	AUDIO ALARM	Alarm table contents (What kind of alarms happened in camera) in basic message area become 0xC1.
CROSS LINE ALARM	0x01	0x38	(WV-SAE200W) CROSS LINE ALARM (WV-XAE200W) CROSS LINE ALARM HUMAN CROSS LINE ALARM VEHICLE CROSS LINE ALARM BICYCLE	Alarm table contents (What kind of alarms happened in camera) in basic message area is 0x43.

VMD ALARM AREA 01	0x01	0x40	VMD ALARM AREA 01	Alarm table contents (What kind of alarms happened in camera) in basic message area become 0x41.
VMD ALARM AREA 02	0x01	0x41	VMD ALARM AREA 02	
VMD ALARM AREA 03	0x01	0x42	VMD ALARM AREA 03	
VMD ALARM AREA 04	0x01	0x43	VMD ALARM AREA 04	
NoMask Alarm	0x01	0x45	NoMask Alarm	Alarm table contents (What kind of alarms happened in camera) in basic message area become 0x43.
AUDIO DETECTION ALARM (GUNSHOT)	0x01	0x46	AUDIO ALARM GUNSHOT	Alarm table contents (What kind of alarms happened in camera) in basic message area become 0xC1.
AUDIO DETECTION ALARM (GLASS BREAK)	0x01	0x47	AUDIO ALARM GLASS BREAK	
AUDIO DETECTION ALARM (VEHICLE HORN)	0x01	0x48	AUDIO ALARM VEHICLE HORN	
AUDIO DETECTION ALARM (YELL)	0x01	0x49	AUDIO ALARM YELL	
AUTO TRACK ALARM AREA 01	0x01	0x50	AUTO TRACK ALARM AREA 01	Alarm table contents (What kind of alarms happened in camera) in basic message area become 0x42.
AUTO TRACK ALARM AREA 02	0x01	0x51	AUTO TRACK ALARM AREA 02	
AUTO TRACK ALARM AREA 03	0x01	0x52	AUTO TRACK ALARM AREA 03	
AUTO TRACK ALARM AREA 04	0x01	0x53	AUTO TRACK ALARM AREA 04	
Occupancy Alarm (Area1)	0x01	0x61	OCCUPANCY ALARM (AREA1)	Alarm table contents (What kind of alarms happened in camera) in basic message area become 0x43.
Occupancy Alarm (Area2)	0x01	0x62	OCCUPANCY ALARM (AREA2)	
Occupancy Alarm (Area3)	0x01	0x63	OCCUPANCY ALARM (AREA3)	
Occupancy Alarm (Area4)	0x01	0x64	OCCUPANCY ALARM (AREA4)	
Wrong-way vehicle (Vehicle Incident Detection)	0x01	0xA3	Stopped vehicle Area XX	Alarm table contents (What kind of alarms happened in camera) in basic message area become is 0x43. XX describes lane No.
Stopped vehicle (Vehicle Incident Detection)	0x01	0xA4	Wrong-way vehicle Area XX	"Alarm table contents (What kind of alarms happened in camera) in basic message area become is 0x43. XX describes lane No.
SD-MEMORY WRITE ERROR	0x01	0xA5	SD-MEMORY WRITE ERROR	Alarm table contents (What kind of alarms happened in camera) in basic message area are first 3 bits : 000b
SD-MEMORY READ ERROR	0x01	0xA6	SD-MEMORY READ ERROR	
SD-MEMORY DELETE ERROR	0x01	0xA7	SD-MEMORY DELETE ERROR	
SD-MEMORY FILESYSTEM ERROR	0x01	0xA8	SD-MEMORY FILESYSTEM ERROR	
SD-MEMORY OTHER ERROR	0x01	0xA9	SD-MEMORY OTHER ERROR	

*1 Termination of message is NULL. After NULL termination NULL should be fulfilled in rest of area at 4byte integral unit

Sender info area

Table contents		Size	Value	Reference
Sender info area	Identifier	2 Byte	0x0002	Fixed area (Sender info area)
	Size	2 Byte	0x0018	Size of extension message size including header info
	MAC address	6 Byte	MAC	MAC address of sender device Byte order is big endian
	Camera No.	2 Byte	0x0000 to 0xFFFF	Maximum camera #, sender device manages (Maximum 65534) Camera : 0x0001 Device which can handle multiple cameras (encoder etc.) : Number of camera No camera included : 0x0000 (configuration information only)
	Year (BCD)	1 Byte	0x00 to 0x99	Time info of sender device
	Month (BCD)	1 Byte	0x01 to 0x12	
	Day (BCD)	1 Byte	0x01 to 0x31	
	Hour (BCD)	1 Byte	0x00 to 0x23	
	Minute (BCD)	1 Byte	0x00 to 0x59	
	Second (BCD)	1 Byte	0x00 to 0x59	
	Time zone ±	1 Byte	0x00, 0x01	Sender time zone info Time zone ± : 0x00 :minus value 0x01 :plus value
	Time zone hour (BCD)	1 Byte	0x00 to 0x23	
	Time zone minute (BCD)	1 Byte	0x00 to 0x59	
	Summer time info	1 Byte	0x00, 0x01	Time zone hour. Minute :Time zone value Summer time info :0x00 :Winter time 0x01 :Summer time
Padding	2 Byte	0x0000		

7.12. HTTP alarm notification

7.12.1. Preface

The specification of HTTP alarm notification of cameras is described in this chapter. Alarm or error commands generated from cameras are sent to external devices such as PC or network disk recorders / cameras of i-PRO by using HTTP.

7.12.2. CGI

[URL] /cgi-bin/set? [<Parameter name>=<Value>]

[Method] POST

[Access level] 1

Parameter name	Value	Comments	Parameter to get current setting (/cgi-bin/getdata)
Func	ImageTransfer	Fixed essential parameter	-
Mmode	0, 128	On/ Off setting for notifying to the destination 1 [Address 1] 0 : Off 128: On (Notify when the alarm is generated)	-
MhttpUrl	Characters	URL for the destination 1 [Address 1] (0 – 255 characters) See 7.12.3	-
MID	Characters	User name (login name) to access the HTTP server for the destination 1 [Address 1] (1 – 63 characters)	-
Mpassword	Characters	Password to access the HTTP server for the destination 1 [Address 1] (0 – 63 characters)	-
Mmode2	128, 0	On/ Off setting for notifying to the destination 2 [Address 2] 0 : Off 128: On (Notify when the alarm is generated)	-
MhttpUrl2	Characters	URL for the destination 2 [Address 2] (0 – 255 characters) See 7.12.3	-
MID2	Characters	User name (login name) to access the HTTP server for the destination 2 [Address 2] (1 – 63 characters)	-
Mpassword2	Characters	Password to access the HTTP server for the destination 2 [Address 2] (0 – 63 characters)	-
Mmode3	128, 0	On/ Off setting for notifying to the destination 3 [Address 3] 0 : Off 128: On (Notify when the alarm is generated)	-
MhttpUrl3	Characters	URL for the destination 3 [Address 3] (0 – 255 characters) See 7.12.3	-

Parameter name	Value	Comments	Parameter to get current setting (/cgi-bin/getdata)
MID3	Characters	User name (login name) to access the HTTP server for the destination 3 [Address 3] (1 – 63 characters)	-
Mpassword3	Characters	Password to access the HTTP server for the destination 3 [Address 3] (0 – 63 characters)	-
Mmode4	128, 0	On/ Off setting for notifying to the destination 4 [Address 4] 0 : Off 128: On (Notify when the alarm is generated)	-
MhttpUrl4	Characters	URL for the destination 4 [Address 4] (0 – 255 characters) See 7.12.3	-
MID4	Characters	User name (login name) to access the HTTP server for the destination 4 [Address 4] (1 – 63 characters)	-
Mpassword4	Characters	Password to access the HTTP server for the destination 4 [Address 4] (0 – 63 characters)	-
Mmode5	128, 0	On/ Off setting for notifying to the destination 5 [Address 5] 0 : Off 128: On (Notify when the alarm is generated)	-
MhttpUrl5	Characters	URL for the destination 5 [Address 5] (0 – 255 characters) See 7.12.3	-
MID5	Characters	User name (login name) to access the HTTP server for the destination 5 [Address 5] (1 – 63 characters)	-
Mpassword5	Characters	Password to access the HTTP server for the destination 5 [Address 5] (0 – 63 characters)	-

The following characters for “MHttpUrl” parameter need to convert

Original character	Converted character
?	%3f
=	%3d
&	%26

[Command examples]

Alarm notification settings (notify 192.168.0.200 (server address) of “/cgi-bin/comalarm.cgi?CMD=01” when the alarm occurs.

<http://192.168.0.10/cgi-bin/set?Func=ImageTransfer&MMode=128&MHttpUrl=http://192.168.0.200/cgi-bin/comalarm.cgi%3fCMD%3d01&MID=user&MPassword=pass>

7.12.3. Alternative character string

When you use the following characters for "MHttpRequest#" parameter, the various information can be obtained when it is notified from the camera.

No.	Converted character for MHttpRequest# parameter	Comments	Remarks
1	%ano	Alarm No.	
2	%pofj	The alarm image saving interval (image saving interval in SD card, transmitted image interval to FTP server)	
3	%atime	Alarm occurrence date and time format : YYMMDDHHMMSS year (2 digits) + month (2 digits) + day (2 digits) + hour (2 digits) + minute (2 digits) + second (2 digits) e.g.: Alarm occurrence date and time is 12/4/2020 9:32:19AM Result: 201204093219	
4	%almsrc	Alarm type high order 3-bit : Alarm contents (Cause of alarm) low order 5-bit : Alarm terminal # (Alarm terminal number) #This contents are the same as the description in 7.11 TCP alarm(Panasonic Alarm protocol).	
5	%gmt	Time zone Format: '+' or '-' HHMM '+' or '-' (a digit) + hour (2 digits) + minutes (2 digits) e.g.: GMT+9:00 +0900 GMT+0:00 +0000	
6	%st_env	Daylight saving time On / Off 1: Daylight saving time ON 0: OFF	
7	%ftpponj	The number of alarm image to be saved (the number of images in SD card, the number of transmitted images to FTP server)	
8	%category	Category (fixed value: 1)	
9	%ip	IP address of the camera e.g.: 192.168.0.10	
10	%mac	MAC address of the camera e.g.: 00-80-45-49-ff-ff	

8. SD memory card recording

8.1. Capability information

CGI: /cgi-bin/get_capability

Related response:

[Example]

```
video_server.sdcard.supported=yes  
video_server.sdcard.media_type=sd,sdhc,sdxc  
video_server.sdcard.recording_stream.number=2  
video_server.sdcard.replay_mp4.supported=yes  
video_server.sdcard.replay_mp4.audio_supported=yes
```

[Overview]

[video_server.sdcard.<Parameter name>=<Value>](#)

Parameter name	Value	Comments
supported	yes, no	SD card is supported or not supported
media_type	sd, sdhc, sdxc	Supported type of the SD memory card.

[The Number of Recording stream]

[video_server.sdcard.recording_stream.number=<numerical value>](#)

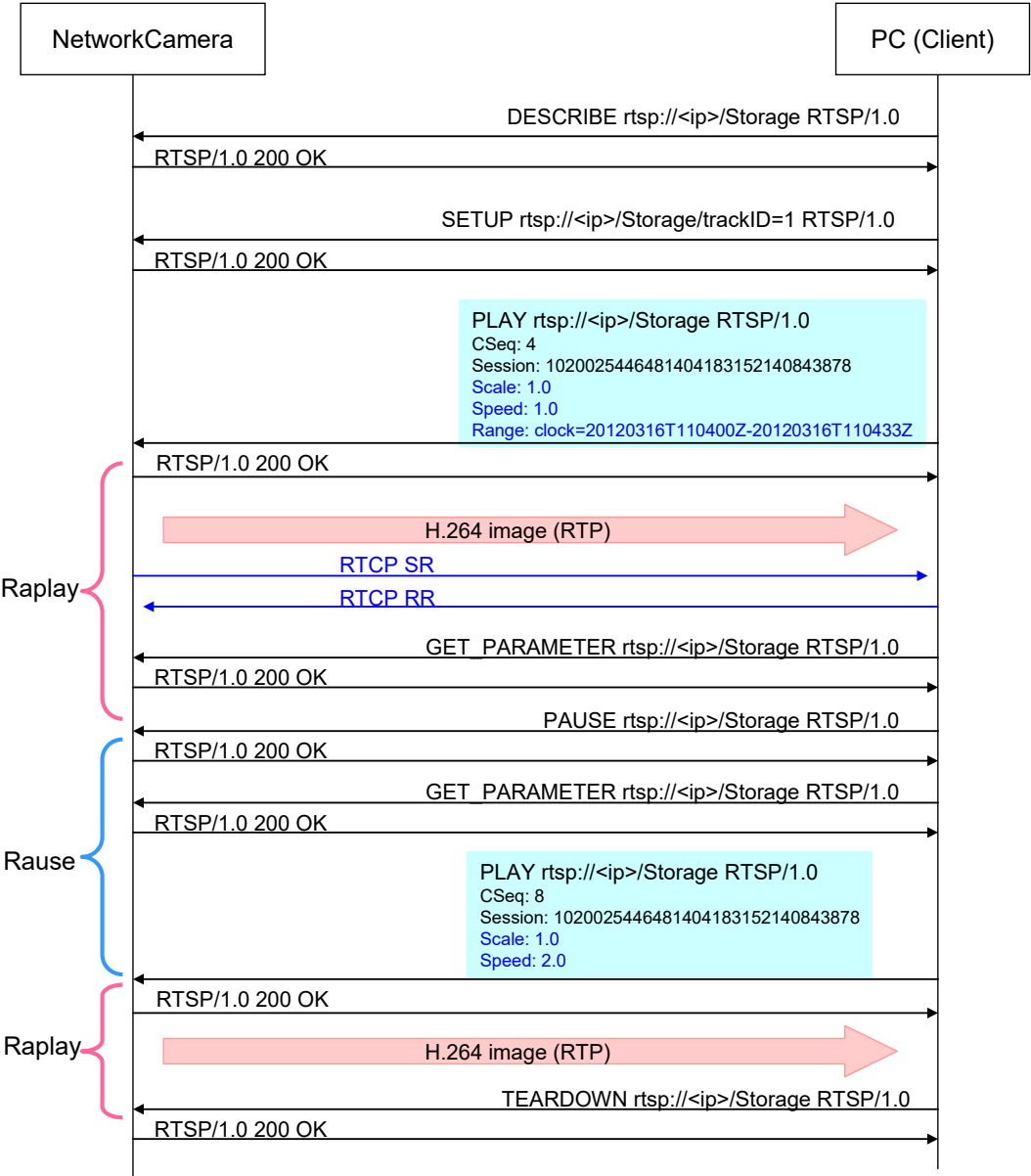
[Playback]

[video_server.sdcard.replay_mp4.<Parameter name>=<Value>](#)

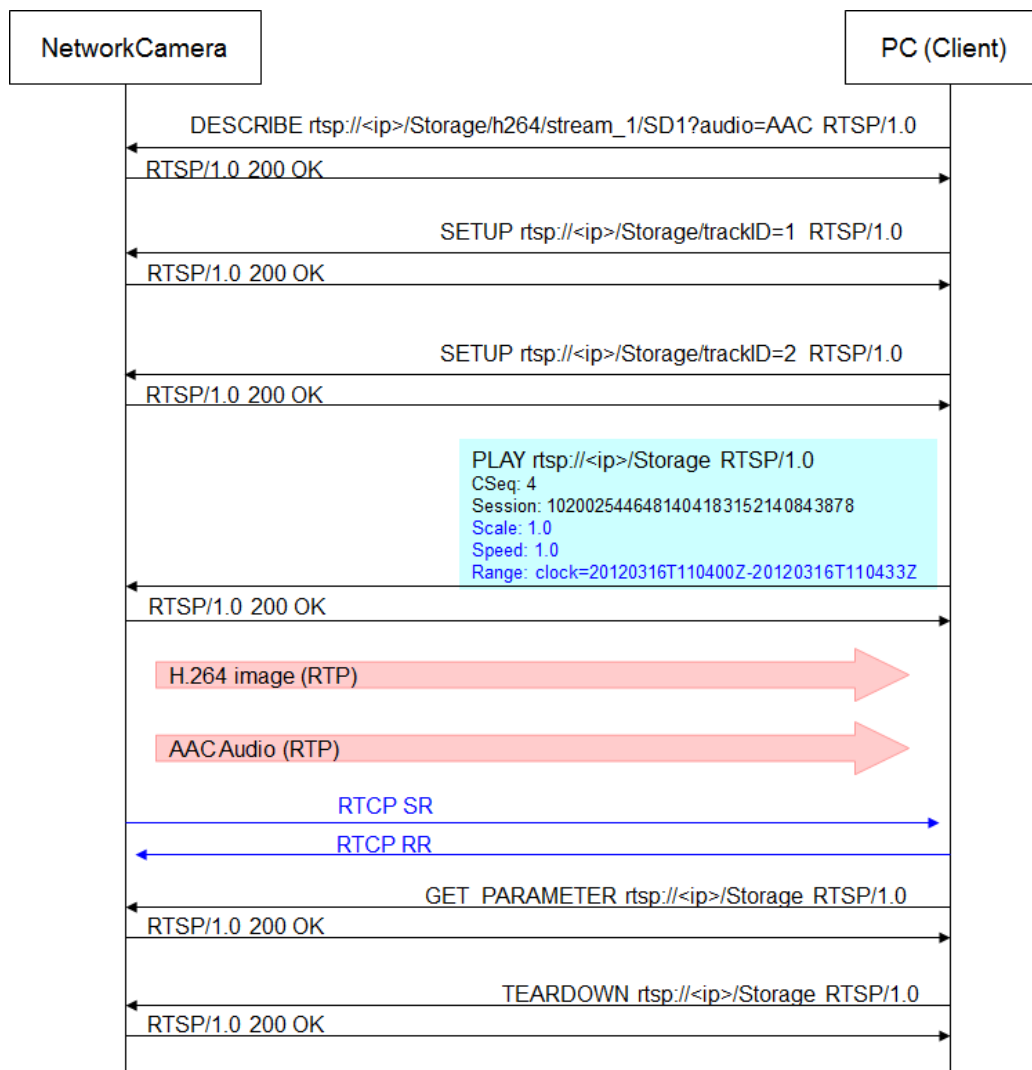
Parameter name	Value	Comments
supported	yes, no	Playback video is supported or not supported
audio_supported	yes, no	Playback audio is supported or not supported

8.2. Request play back stream

8.2.1. RTSP sequence



8.2.2. RTSP sequence with Audio



8.2.3. RTSP URL

rtsp://<ip address>/Storage/ [<stream>] [<ch>] [?audio=AAC]

Parameter name	Value	Comments
<stream>	stream_1 stream_2	Recording stream * When this parameter is omitted, it works as a stream_1
<ch>	ch_1 ch_2 ch_3 ch_4	Channel: ch_1: Camera 1 ch_2: Camera 2 ch_3: Camera 3 ch_4: Camera 4 [Note] This parameter is supported by Multi-sensor models.
?audio=AAC		Replaying audio data. *When this parameter is omitted, camera replays only image data.

e.g.) Replay including voice of Recording stream 1.

rtsp://<ip address>/Storage/stream_1?audio=AAC

e.g.) Replay without voice of Recording stream 2.

rtsp://<ip address>/Storage/stream_2

8.2.4. RTSP header for Replay

Here lists header fields of PLAY method supported for replay in accordance with RFC2326.

Header Field	Description
Range	Indicate playback span with UTC range time. Play from a given point to the end.
Scale	1 (Fixed value) Value of 1 indicate normal play.
Speed	Change the bandwidth used for data delivery. Accept value from 0.5 to 5.0 times, and maximum bandwidth is limited to 4Mbps.
Immediate	If receiving a PLAY command with the Immediate header set to "yes", it will immediately start playing from the new location, cancelling any existing PLAY command.

The following is a sample of PLAY request with "Immediate" header.

```
client->server:
  PLAY rtsp://10.1.1.2:554/Storage/1 RTSP/1.0
  CSeq: 65
  Session: 0847397782
  Range: clock=19961108T143720.25Z-
  Authorization: Basic cm9vdDp0YXJnZXQ=
  Scale: 1.0
  Speed: 2.0
  Immediate: yes
```

8.2.5. RTP header extension

H.264/H.265 RTP header

Bit Byte	0.				8.		16.		24.		
	2	1	1	4	1	7	8		8		
RTP header	0	V	P	X	CC	M	PT		Sequence number		
	4	Timestamp									
	8	SSRC (Synchronization Source Identifier)									
extension	12	Defined by profile					Extension length				
	16	meta information (Additional Information) (1)									
		meta information (Additional Information) (n)									

Parameter name	length(Bit)	Values and comments
V (Version)	2	2 (fixed)
P (Padding)	1	0 (fixed)
X (Extension)	1	0: false , 1: true
CC (CSRC Count)	4	0 (fixed)
M (Marker)	1	In case of the last RTP packet of VOP, this value is set to 1
PT (Payload Type)	7	96 (fixed)
Sequence number	16	The value in which one increment is done in each RTP packet is set. An initial value is generated at random.
Timestamp	32	3000 count improvements are done in each 33msec.
SSRC	32	0x0000 0000 (fixed)
CSRC	0	Unused
Defined by profile(*)	16	0 (fixed)
Extension length(*)	16	Length of the Header Extension (Unit of 32bit word)
meta information (Additional Information) (*)		Refer to CGI interface document. chapter 13

Time information (second)

Byte	Bit	0.		8.		16.		24.	
		0	4	0	4	0	4	0	4
0	0	ID				Length			
	4	Clock							
	8	TimeZoneDirection		TimeZoneHour		TimeZoneMinute		SummerTime	

Parameter name	length(Bit)	Values and comments
ID	16	0x0011 (fixed)
Length	16	Total Data length (include ID and Length) (Unit of byte)
Clock	32	The career second from 1970
TimeZoneDirection	8	The direction of time zone 0x00 : positive value 0x01 : negative value

TimeZoneHour	8	Time zone (hour) 0x00: 0hours, 0x01: 1hours, 0x02: 2hours, 0x03: 3hours 0x04: 4hours, 0x05: 5hours, 0x06: 6hours, 0x07: 7hours 0x08: 8hours, 0x09: 9hours, 0x0a: 10hours, 0x0b: 11hours 0x0c: 12hours, 0x0d: 13hours, 0x0e: 14hours, 0x0f: 15hours 0x10: 16hours, 0x11: 17hours, 0x12: 18hours, 0x13: 19hours 0x14: 20hours, 0x15: 21hours, 0x16: 22hours, 0x17: 23hours
TimeZoneMinute	8	Time zone (minute) 0x00: 0minutes, 0x01: 1minutes, 0x02: 2minutes,, 0x39: 57minutes, 0x3a: 58minutes, 0x3b: :59minutes
SummerTime	8	0x00 :Not daylight saving time 0x01 :Daylight saving time (Summer time)

Frame time information (millisecond)

Bit		0.	8.	16.	24.
Byte		ID		Length	
0	0	FrameTime		C E D	CSeq
	4			mbz	

Parameter name	length(Bit)	Values and comments
ID	16	0x0012 (fixed)
Length	16	Total Data length (include ID and Length) (Unit of byte)
FrameTime	16	Millisecond (Unit of 10 milliseconds) 0x0000: 0 millisecond, 0x0001: 10 milliseconds,, 0x0062: 980 milliseconds, 0x0063: 990milliseconds
Padding	16	0x0000 (fixed)
C/E/D, mbz	8	C(1bit): synchronization point or "clean point" E(1bit): the end of a contiguous section of recording D(1bit): a discontinuity in transmission Mbz(5bit): Reserved. It must be zero.
CSeq	8	low-order byte of the CSeq value used in the RTSP PLAY command

C/E/D bit, CSeq are added in replay only.

8.3. Recording search

8.3.1. Recording Summary

[URL] /cgi-bin/get_recording_summary[?ch=<Value>]

[Method] GET

[Access level] 3

Parameter name	Value	Comments
ch	1, 2, 3, 4	Channel 1: Channel 1 2: Channel 2 3: Channel 3 4: Channel 4 [Note] This parameter is supported by Multi-sensor models.

[Command examples]

http://192.168.0.10/cgi-bin/get_recording_summary

Response of recording summary (http://192.168.0.10/cgi-bin/get_recording_summary)
 Response is shown below.

```

-----
HTTP/1.1 200 OK[CR][LF]
Content-type: text/plain[CR][LF]
[CR][LF]
DataFrom=<Datafrom>[CR][LF]
DataUntil=<DataUntil>[CR][LF]
-----
  
```

Parameter name	Response value	Comments
DataFrom	UTC time	The earliest point in time where there is recorded data on the device.
DataUntil	UTC time	The most recent point in time where there is recorded data on the device.

8.3.2. GetMeidaAttributes

[URL] /cgi-bin/get_media_attributes?time=<Value>[&ch=<Value>]

[Method] GET

[Access level] 3

Parameter name	Value	Comments
time (Mandatory)	UTC time	Time format describe follow. Time =[yyyymmdd]T[hhmmss.xx]Z
ch	1, 2, 3, 4	Channel 1: Channel 1 2: Channel 2 3: Channel 3 4: Channel 4 [Note] This parameter is supported by Multi-sensor models.

[Command examples]

http://192.168.0.10/cgi-bin/get_media_attributes?time=20200123T123456Z

(2020 23rd, Jan. 12:34:56)

Response of GetMediaAttributes(http://192.168.0.10/cgi-bin/get_recording_summary)

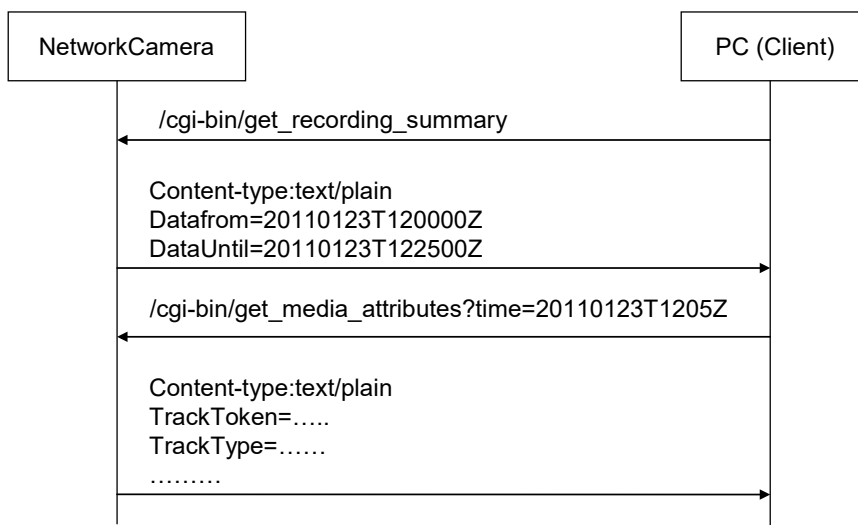
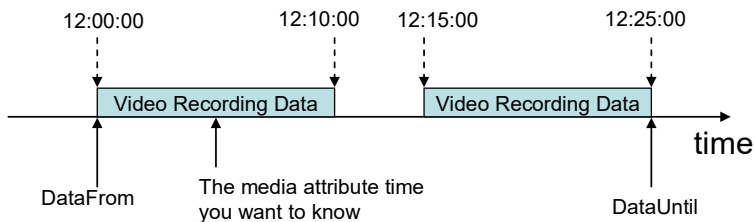
Response is shown below.

```

-----
HTTP/1.1 200 OK[CR][LF]
Content-type: text/plain[CR][LF]
[CR][LF]
TrackToken=<Track name>[CR][LF]
TrackType=<media type>[CR][LF]
DataFrom=<DataFrom>[CR][LF]
DataTo=<DataTo>[CR][LF]
[CR][LF]
vBiterate=<Biterate>[CR][LF]
vWidth=<video Width>[CR][LF]
vHeight=<video Height>[CR][LF]
vEncoding=<Encoding Type>[CR][LF]
vFramerate=<video Framerate>[CR][LF]
[CR][LF]
From=<From>[CR][LF]
Until=<Until>[CR][LF]
-----

```

Parameter name	Response value	Comments
TrackToken	Characters	a unique identifier of the track.
TrackType	Video	Type of the track
DataFrom	UTC time	The date and time of the oldest data in the track.
DataTo	UTC time	The date and time of the newest data in the track.
vBitrate	64, 128, 256, 384, 512, 768, 1024, 1536, 2048, 3072, 4096, F_4096, F_unlimited	Average bitrate in kbps.
vWidth	1280, 800, 640, 320	The width of the video in pixels.
vHeight	960, 600, 480, 240 720, 360, 180	The height of the video in pixels.
vEncoding	H264	Used video codec, either Jpeg, H.264 or H.265
vFramerate		Average framerate in frames per second.
From	UTC time	The attributes are valid from this point in time in the recording.
Until	UTC time	The attributes are valid until this point in time in the recording. Can be equal to 'From' to indicate that the attributes are only known to be valid for this particular point in time.



8.3.3. FindRecordingSequences

Start a search session, looking for recordings that matches duration of the time defined in the request. Results from the search are acquired using a GetRecordingSequenceSearchResults request.

[URL] /cgi-bin/find_recording_seqs?keepalivetime=<Value>[&<Parameter name>=<Value>]

[Method] GET

[Access level] 3

Parameter name	Value	Comments
Maxmatches (Optional)	1-1000	The search will be completed after this many matches. If not specified, the search will continue until reaching the endpoint or until the session expires.
Keepalivetime (Mandatory)	1-300(Sec)	The time the search session will be kept alive after responding to this and subsequent requests.
Datafrom (Optional)	UTC time	Start time to search session.
Datato (Optional)	UTC time	End time to search session.
ch	1, 2, 3, 4	Channel 1: Channel 1 2: Channel 2 3: Channel 3 4: Channel 4 #This parameter is supported by Multi-sensor models.

[Command examples]

Find all recordings.

http://192.168.0.10/cgi-bin/find_recording_seqs?keepalivetime=120

Find recordings from 2020/1/23 12:00 to 2020/1/23 12:30

http://192.168.0.10/cgi-bin/find_recording_seqs?keepalivetime=120&Datafrom=20200123T120000Z&Datato=20200123T123000Z

Find up to 10 recordings after 2020/1/23 12:00.

http://192.168.0.10/cgi-bin/find_recording_seqs?keepalivetime=120&MaxMatches=10&Datafrom=20200123T120000Z

Response data is shown below

```

-----
HTTP/1.1 200 OK[CR][LF]
Content-type: text/plain[CR][LF]
Content-Length: *****[CR][LF]
[CR][LF]
SearchToken=<Characters>[CR][LF]
-----

```

Parameter name	Response value	Comments
SearchToken	Characters	a unique identifier of the search job. This parameter is decided by the Camera.

8.3.4. GetRecordingSequencesSearchResults

Acquire the results from a recording search session previously initiated by a FindRecordingSequences operation.

[URL] /cgi-bin/get_recording_seq_search_results?SearchToken=<Value>[&<Parameter name>=<Value>]
[Method] GET
[Access level] 3

Parameter name	Value	Comments
SearchToken (Mandatory)	Characters	Please use the search token that is response of /cgi-bin/find_recording.
MaxResults (Optional)	1-1000	The maximum number of results to return in one response.
WaitTime (Optional)	1-120(sec)	The maximum time before responding to the request, even if the MinResults parameter is not fulfilled.

[Command examples]

Get search results.

http://192.168.0.10/cgi-bin/get_recording_seq_search_results?SearchToken=0001

Get maximum 10 search results.

http://192.168.0.10/cgi-bin/get_recording_seq_search_results?SearchToken=0001&MaxResults=10

Get results until maximum 30 seconds in wait time.

http://192.168.0.10/cgi-bin/get_recording_seq_search_results?SearchToken=0001&WaitTime=30

GetRecordingSeqSearchResults shall block until:

- 1) Search is completed or stopped.
- 2) WaitTime has expired.
- 3) MaxResults results are available for the response if MaxResults is specified.

MinResults results are ignored.

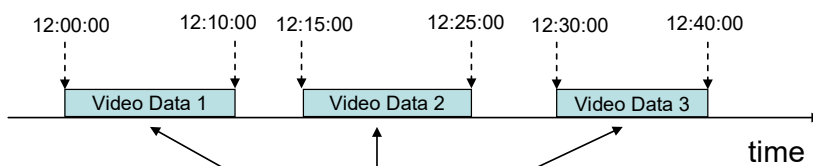
Response data is shown below

```
-----  
HTTP/1.1 200 OK[CR][LF]  
Content-type: text/plain[CR][LF]  
Content-Length: *****[CR][LF]  
[CR][LF]  
SearchState=<Search state>[CR][LF]  
EarliestRecording=<Earliest Recording time>[CR][LF]  
LatestRecording=<Latest Recording time>[CR][LF]  
StreamNum=<Number of Stream>[CR][LF]  
[CR][LF]  
1:TrackToken=<TrackToken>[CR][LF]  
1:TrackType=<Media Type>[CR][LF]  
1:DataFrom=<Data From>[CR][LF]  
1:DataTo=<Data To>[CR][LF]  
RecordingStatus=<Recording Status>[CR][LF]  
-----
```

Below is a sample response with no search result.

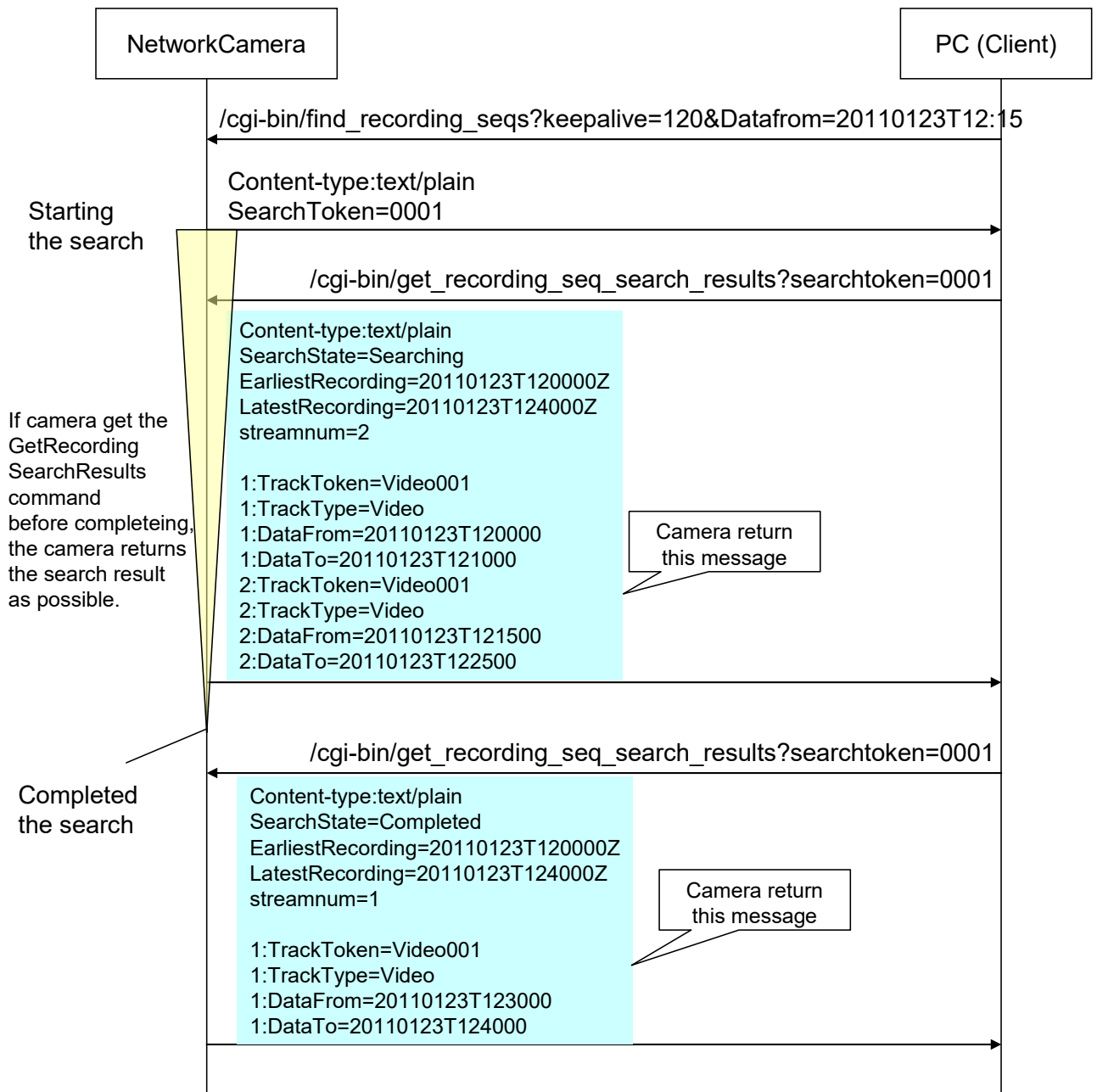
```
-----  
FindRecordingSequences:Response  
StatusCode:OK  
Content-type:text/plain  
ResponseData:SearchState=Completed  
EarliestRecording=00000000T000000.00Z  
LatestRecording=00000000T000000.00Z  
StreamNum=0  
-----
```

[Sequence]
(Time line example)



There are 3 recording streams for video.

(Sequence of finding recording.)



8.3.5. EndSearch

[URL] [/cgi-bin/end_search?SearchToken=<Value>](#)

[Method] GET

[Access level] 3

Parameter name	Value	Comments
SearchToken (Mandatory)	Characters	Please use the search token that is response of /cgi-bin/find_recording_seqs.

[Command example]

Stop the Search Job

<http://192.168.0.10/cgi-bin/EndSearch?SearchToken=0001>

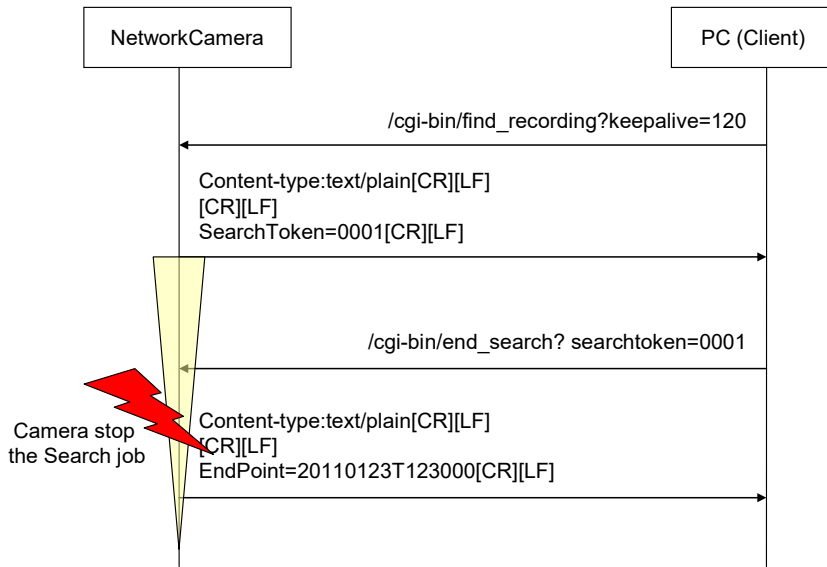
Response data is shown below

```
-----  
HTTP/1.1 200 OK[CR][LF]  
Content-type: text/plain[CR][LF]  
[CR][LF]  
Endpoint=<Endpoint time>[CR][LF]  
-----
```

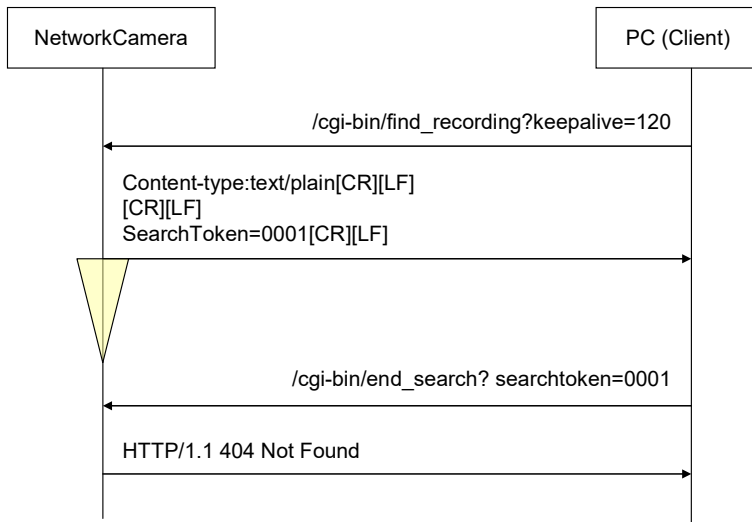
Parameter name	Response value	Comments
Endpoint	UTC time	The point of time the search had reached when it was ended. It is equal to the EndPoint specified in Find-operation if the search was completed.

[Sequence]

CASE 1 : Success(Search State of the camera is Searching)



CASE 2 : Fail (Search State of the camera is Complete)



8.3.6. GetRecordingListSearchResults (MP4)

Start a search Recording data(MP4 file) from SD card, looking for recording list that matches duration of the time defined in the request.

The response from camera may be longer than GetMeidaAttributes, FindRecordingSequences and GetRecordingSequencesSearchResults.

[URL] /cgi-bin/get_mp4_list[?<Parameter name>=<Value>]

[Method] GET

[Access level] 1

Parameter name	Value	Comments
Maxmatches (Optional)	1-100	The search will be completed after this many matches. If not specified, the search will continue until reaching the endpoint or until the session expires.
Datafrom (Optional)	UTC time	Start time to search session. Result is files include Dataform time
Datato (Optional)	UTC time	End time to search session. Result is files include Datato time
ch	1, 2, 3, 4	Channel 1: Channel 1 , 2: Channel 2, 3: Channel 3, 4: Channel 4 #This parameter is supported by Multi-sensor models.

[Command examples]

Find all recordings.

http://192.168.0.10/cgi-bin/get_mp4_list

Find recordings from 2020/1/23 12:00 to 2020/1/23 12:30.

http://192.168.0.10/cgi-bin/get_mp4_list?Datafrom=20200123T120000Z&Datato=20200123T123000Z

Find up to 100 recordings from 2020/1/23 12:00 to 2020/1/23 12:30.

http://192.168.0.10/cgi-bin/get_mp4_list?Datafrom=20200123T120000Z&Datato=20200123T123000Z&Maxmatches=100

[Response format]

```

-----
HTTP/1.1 200 OK[CR][LF]
Connection: Close[CR][LF]
Content-type: text/plain[CR][LF]
[CR][LF]
10000001_ymmddhhmmss_A.mp4,<start_time>,<end_time>[CR][LF]
10000002_ymmddhhmmss_A.mp4,<start_time>,<end_time>[CR][LF]
      ⋮
10000051_ymmddhhmmss_L.mp4,<start_time>,<end_time>[CR][LF]
MP4fileNum=51
-----

```

Parameter name	Response value	Comments
MP4fileNum	< number >	Number of search result of MP4 data. When the file doesn't exist, '0' would be returned.
<start_time>	yyyymmddThhmmss(.xx)Z	The start time of the recording at a MP4 file
<end_time>	yyyymmddThhmmss(.xx)Z	The end time of the recording at a MP4 file.

[Response data]

Success	200 OK
Already searching	200 OK (Describes ' ErrorNo=3 ' in the text response) *1
SD memory card is not supported	404 Not found
The SD memory card setting is set to 'Not use'.	503 Service Unavailable
SD memory card is not recognized	503 Service Unavailable
The recording format setting is not set to 'H.264'.	503 Service Unavailable

*1: It is a case of using the following cgi.

- /cgi-bin/get_mp4_list
- /cgi-bin/find_recording_seqs
- /cgi-bin/get_recording_seq_search_results

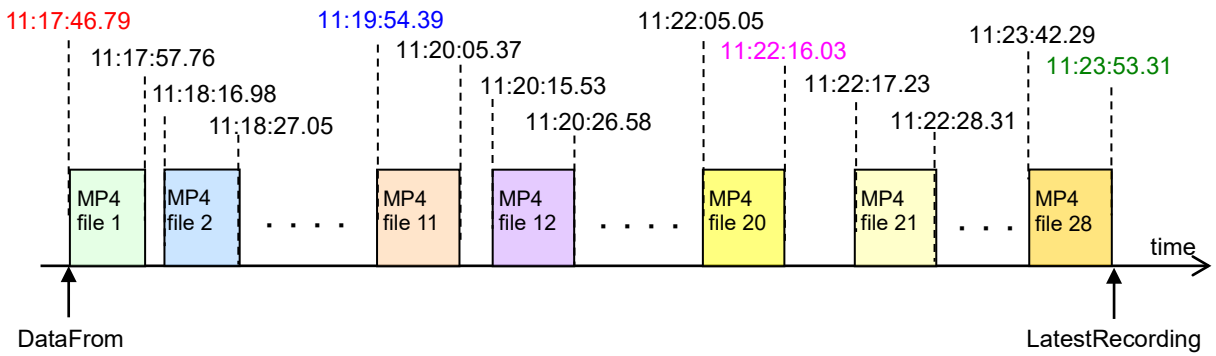
The response format is described as following.

```

-----
HTTP/1.1 200 OK[CR][LF]
Connection: Close[CR][LF]
Content-type: text/plain[CR][LF]
[CR][LF]
ErrorNo=3[CR][LF]
-----

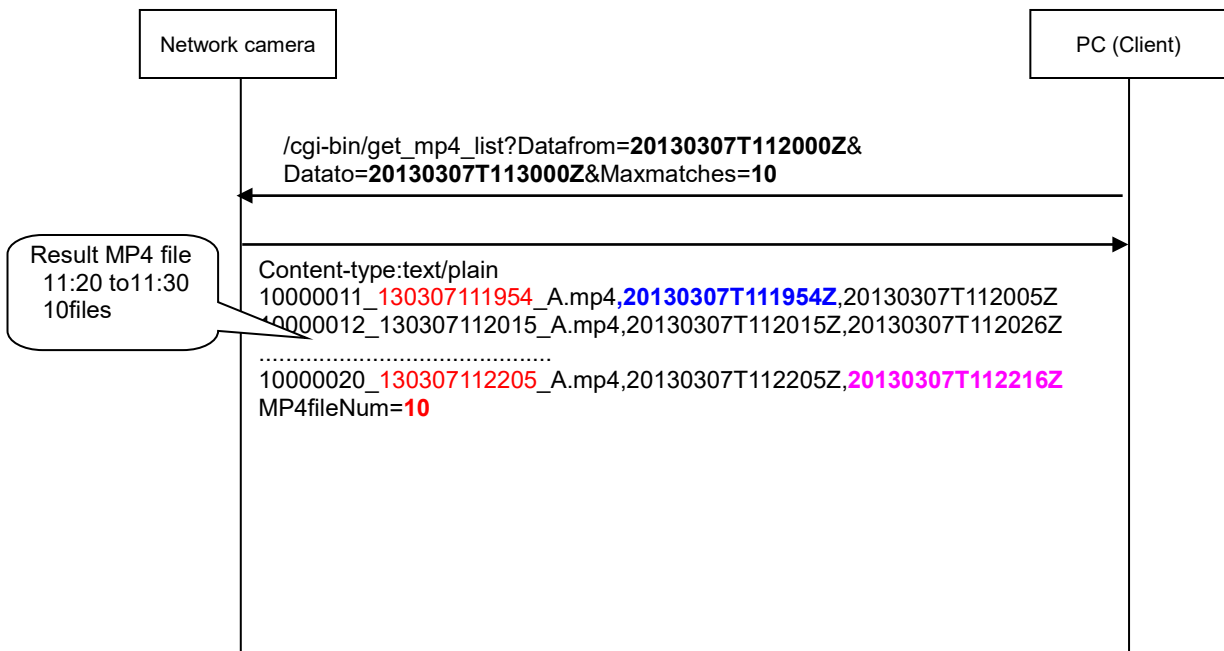
```

[Response examples and sequences]

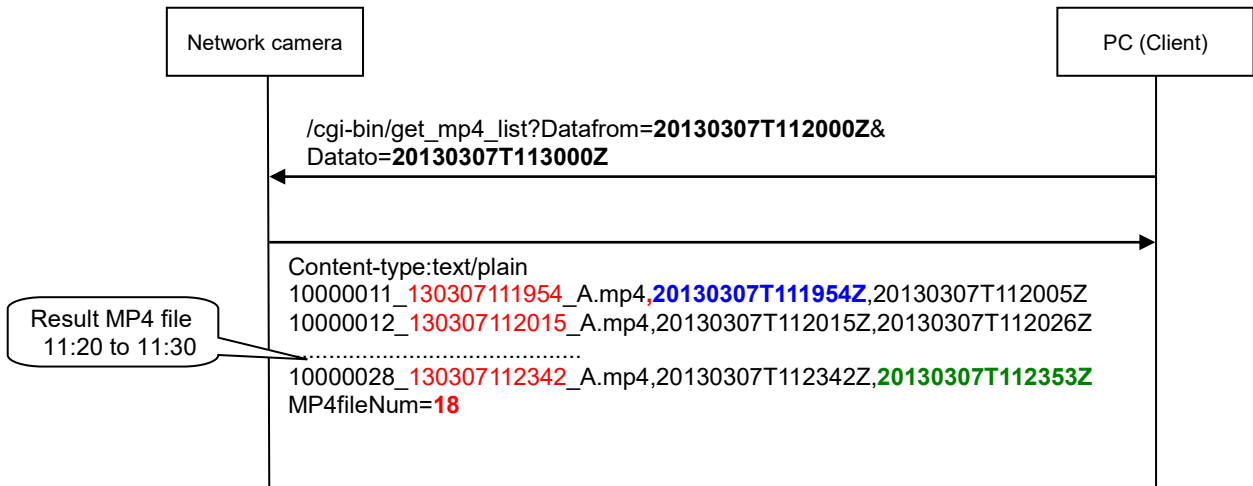


28 files exist on the SD memory card

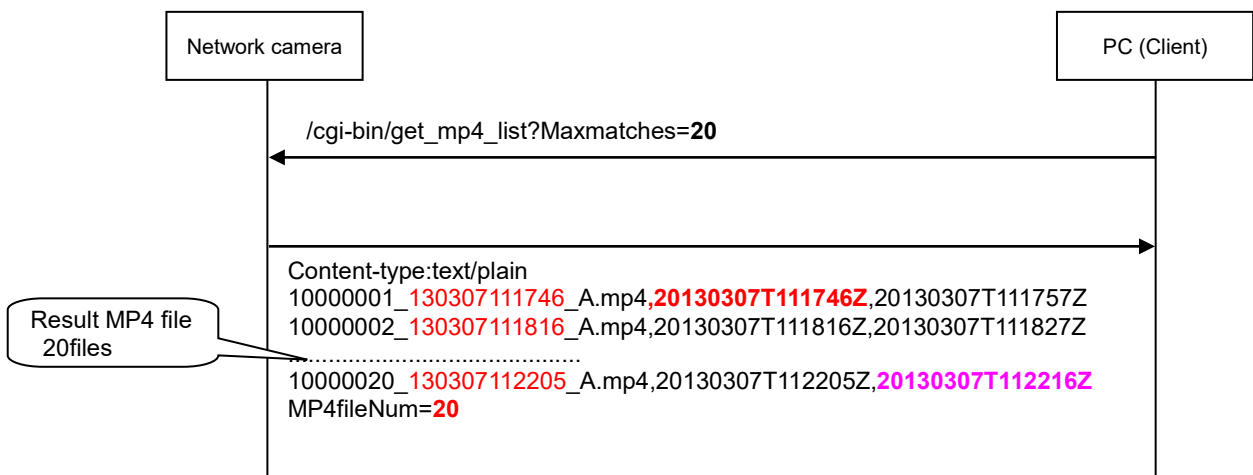
1) Starts searching with start/end time and maximum file number.



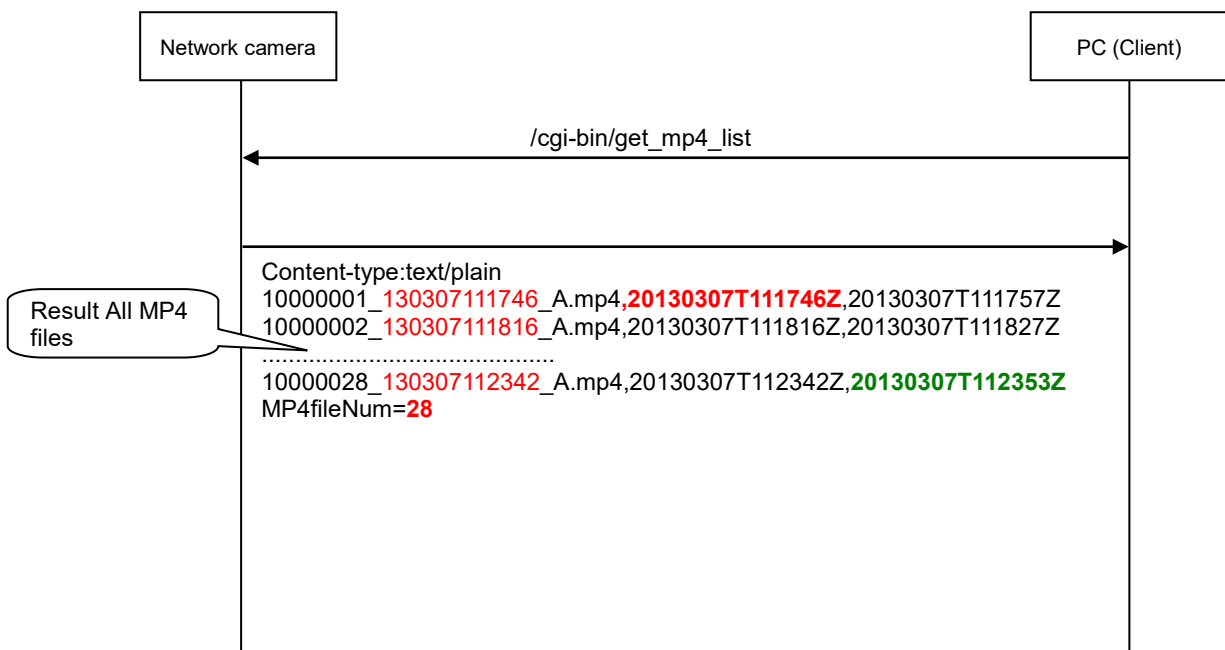
2) Starts searching with start/end time



3) Starts searching with maximum file number



4) Starts searching with no options.



8.4. MP4 Download

This command can be used for downloading the MP4 files in the SD memory card from the camera. It can download MP4 specified by the filename. This command is used with "GetRecordinListSearchResults (MP4 file)".

[URL] /cgi-bin/get_mp4_file?FileName=<Value>[&ch=<Value>]

[Method] GET

[Access level] 3

Parameter name	Value	Comments
FileName	Characters	MP4 filename to download
ch	1, 2, 3, 4	Channel 1: Channel 1, 2: Channel 2, 3: Channel 3, 4: Channel 4 #This parameter is supported by Multi-sensor models.

[Command examples]

Download MP4 file (filename: 10000001_yyyymmddhhmmss_L.mp4)

http://192.168.0.10/cgi-bin/get_mp4_file?FileName=10000001_yyyymmddhhmmss_L.mp4

[Response data]

Success	200 OK
While replaying	200 OK (Describes ' ErrorNo=2 ' in the text response) *2
Already downloading	200 OK (Describes ' ErrorNo=3 ' in the text response) *3
The MP4 file specified doesn't exist in the SD memory card.	200 OK (Describes ' ErrorNo=4 ' in the text response) *4
SD memory card is not supported	404 Not found
The SD memory card setting is set to 'Not use'.	503 Service Unavailable
SD memory card is not recognized	503 Service Unavailable
The recording format setting is not set to 'H.264'.	503 Service Unavailable

*2: The description of the replaying is described in chapter 8.2.

The response format is described as following.

```

-----
HTTP/1.1 200 OK[CR][LF]
Connection: Close[CR][LF]
Content-type: text/plain[CR][LF]
[CR][LF]
ErrorNo=2[CR][LF]
-----

```

*3: The response format is described as following.

```
-----  
HTTP/1.1 200 OK[CR][LF]  
Connection: Close[CR][LF]  
Content-type: text/plain[CR][LF]  
[CR][LF]  
ErrorNo=3[CR][LF]  
-----
```

*4: The response format is described as following.

```
-----  
HTTP/1.1 200 OK[CR][LF]  
Connection: Close[CR][LF]  
Content-type: text/plain[CR][LF]  
[CR][LF]  
ErrorNo=4[CR][LF]  
-----
```

8.5. SD memory card setup

8.5.1. SD memory card recording setup

[URL] /cgi-bin/set_sdcard[?<Parameter name>=<Value>]

[Method] POST

[Access level] 1

Parameter name	Value	Comments	Parameter to get current setting (/cgi-bin/getdata)
sdcard	0,1	SD memory card setting 0: Off (Not use), 1: On (Use)	SDCARD
h264_rec_audio	0,1	Audio recording 0: Off, 1: On (Use)	SDREC_AUDIO
audio_codec	2	2: AAC (fixed)	-
remain_notice	50,20, 10,5,2	Remaining capacity notification 50: 50%, 20: 20%, 10: 10%, 5: 5%, 2: 2%	SDREMNOTICE
sdrec_mode	alm, local, sdrec, nwlost	Save trigger for Recording stream 1 alm: Saves images at an alarm occurrence. local: Saves images manually. sdrec: Saves images in accordance with the settings for 'Schedule' (refer to chapter 12) nwlost: network failure trigger base SD backup (refer to chapter 8.7)	SDREC
sdrec_mode_2	alm,local, sdrec	Save trigger for Recording stream 2	SDREC_2
sdrec_ptn	full, repeat	Overwrite full: Stops saving images on the SD memory card when the SD memory card becomes full. repeat: Overwrites when the SD memory card becomes full. (The oldest image is the first to be overwritten.)	SDRECPTN
sdrec_target	h264_1, h264_2, h264_3, h264_4, jpeg, jpeg_2, jpeg_3	Recording stream 1 format h264_1: Stream(1) recording, h264_2: Stream(2) recording, h264_3: Stream(3) recording, h264_4: Stream(4) recording, jpeg: JPEG(1) recording, jpeg_2: JPEG(2) recording jpeg_3: JPEG(3) recording	SDRECCODEC
sdrec_target_2	off h264_1, h264_2, h264_3, h264_4	Recording stream 2 format off: OFF h264_1: Stream(1) recording, h264_2: Stream(2) recording, h264_3: Stream(3) recording, h264_4: Stream(4) recording,	SDRECCODEC2
alm_rec_time	10,20, 30,40, 50,60, 120,180, 240,300	Post alarm (Recording) duration. Set the duration to save image data on the SD memory card after an alarm occurrence (H.264/H.265 recording). 10 :10s , 20 :20s, 30 :30s, 40 :40s, 50 :50s, 60 :60s, 120 :120s, 180 :180s, 240 :240s, 300 :300s	ALMRECTIME

alm_rec_time_pre	0,1,2,3,4,5,8,10,15,20,25,30,40,50,60,90,120	Pre alarm (Recording) duration. # The available values change depending on the bit rate and image capture size for "Stream" selected for recording. As the selected bit rate increases, the available maximum value for the pre alarm duration decreases	PREALM_TIME
rec1_event_trm1	0,1	Save the image when an alarm occurs in Terminal 1 for Recording stream 1 0: OFF, 1: ON(Default)	SDREC_TRM1
rec1_event_trm2	0,1	Save the image when an alarm occurs in Terminal 2 for Recording stream 1	SDREC_TRM2
rec1_event_trm3	0,1	Save the image when an alarm occurs in Terminal 3 for Recording stream 1	SDREC_TRM3
rec1_event_vmd	0,1	Save the image when VMD occurs for Recording stream 1. 0: OFF, 1: ON(Default)	SDREC_VMD
rec1_event_com	0,1	Save the image when a command alarm is entered for Recording stream 1 0: OFF, 1: ON(Default)	SDREC_COM
rec1_event_audiodetect	0,1	Save the image when an audio detection occurs for Recording stream 1. 0: OFF, 1: ON(Default)	SDREC_AUDIODETECT
rec1_event_attrack	0,1	Save the image when an auto track alarm occurs for Recording stream 1. 0: OFF, 1: ON(Default)	-
rec2_event_trm1	0,1	Save the image when an alarm occurs in Terminal 1 for Recording stream 2	SDREC2_TRM1
rec2_event_trm2	0,1	Save the image when an alarm occurs in Terminal 2 for Recording stream 2	SDREC2_TRM2
rec2_event_trm3	0,1	Save the image when an alarm occurs in Terminal 3 for Recording stream 2	SDREC2_TRM3
rec2_event_vmd	0,1	Save the image when VMD occurs for Recording stream 2	SDREC2_VMD
rec2_event_com	0,1	Save the image when a command alarm is entered for Recording stream 2	SDREC2_COM
rec2_event_audiodetect	0,1	Save the image when an audio detection occurs for Recording stream 2.	SDREC2_AUDIODETECT
rec2_event_attrack	0,1	Save the image when an auto track alarm occurs for Recording stream 2.	-

[Command example]

Change setting to use SD memory card.

http://192.168.0.10/cgi-bin/set_sdc card?sdcard=1

Change setting to use audio recording.

http://192.168.0.10/cgi-bin/set_sdc card?h264_rec_audio=1&audio_codec=2

Change recording format to 'Stream(1)', and save trigger to 'manual rec'.

http://192.168.0.10/cgi-bin/set_sdc card?sdrec_mode=local&sdrec_target=h264_1

Change save trigger to Schedule

http://192.168.0.10/cgi-bin/set_sdc card?sdrec_mode=sdrec

8.5.2. Format the SD memory card

[URL] [/cgi-bin/sdcard?cmd=format](#)

[Method] POST

[Access level] 1

Parameter name	Value	Comments
cmd	format	Format the SD memory card

[Command example]

Format the SD memory card.

<http://192.168.0.10/cgi-bin/sdcard?cmd=format>

8.6. Manual recording

[Description]

There are limited times to overwrite on an SD memory card. When having a high frequency of overwriting, the lifetime of the SD memory card may become shorter.

A lifetime of a SD memory card should be influenced by the number of the image files stored and log savings on the SD memory card. Selecting H.264 for "Recording format" can reduce the number of files to be stored on the SD memory card.

[URL] [/cgi-bin/sdctrl?save=<Value>](#)

[Method] GET

[Access level] 1

Parameter name	Value	Comments
save	start end	Manual recording control start: Start manual recording end : Stop manual recording

[Command example]

Start manual recording.

<http://192.168.0.10/cgi-bin/sdctrl?save=start>

8.7. Network failure trigger base SD backup

8.7.1. Overview

Client has to set “a validity term of SD-card-recording function by detecting network failure” using a following CGI before sending a video stream request. The camera starts to detect a network failure after receiving RTSP stream request with “sdbackup=yes” parameter during the validity term. When the camera detects network failure, it starts to record a video stream to SD card.

When the camera receives the stream request during outside monitoring period, it does not start to detect a network failure.

Main purpose of this function (validity term) is for preventing the excessive writing to SD card and expanding SD lifetime.

Note:

In order to detect network failure, “Save trigger” of SD memory card should be change to “nwlost” by using following CGI beforehand.`/cgi-bin/set_sdcard?sdrec_mode=nwlost`

8.7.2. Set backup schedule

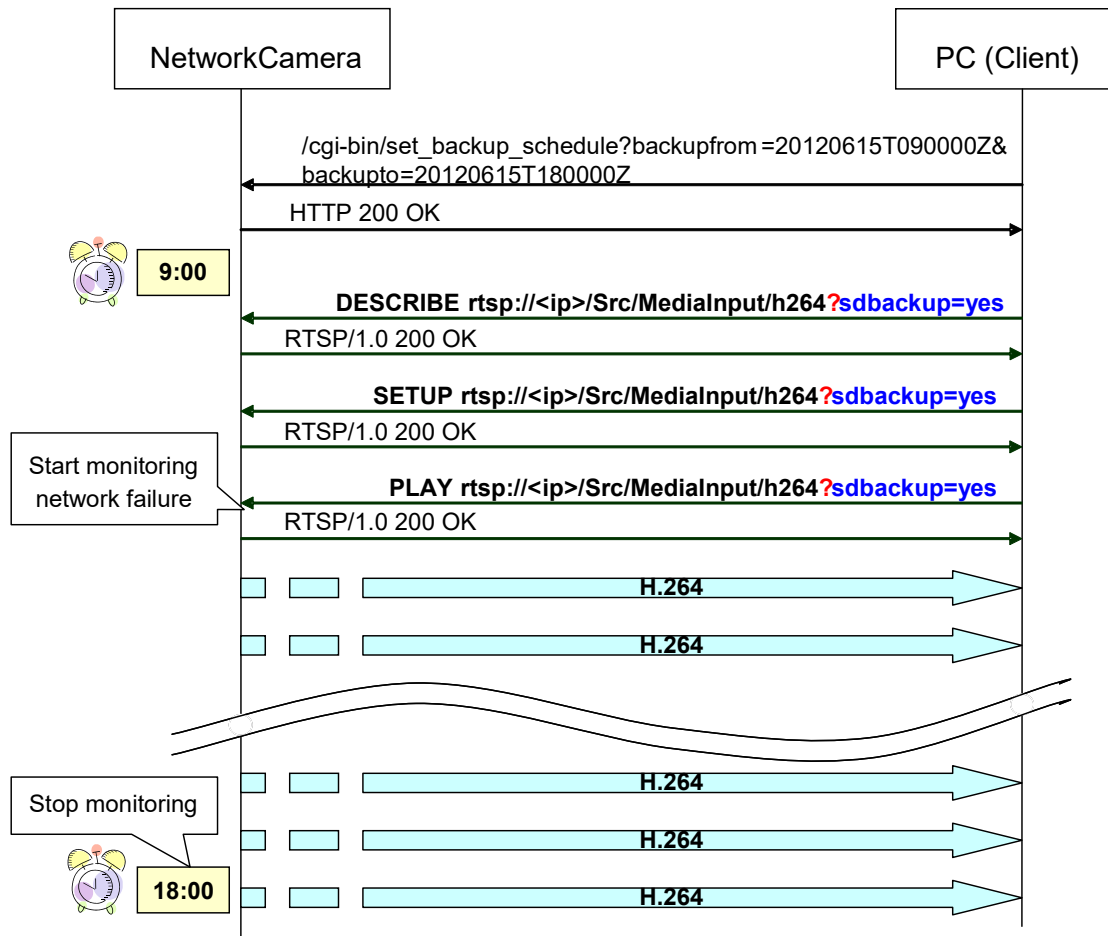
[URL]
`/cgi-bin/set_backup_schedule?backupfrom=<Value>&backupto=<Value>[&<Parameter name>=<Value>]`
[Method] POST
[Access level] 1

Parameter name	Value	Comments
backupfrom (Mandatory)	UTC time	Start time of monitoring period of network failure. Time format describe follow. Time =[yyyymmdd]T[h:mm:ss]Z Ex) 20120201T120000Z
backupto (Mandatory)	UTC time	Start time of monitoring period of network failure. Ex) 20120201T130000Z
interval (Optional)	1-100 (sec)	Keep Alive interval that client sends to camera. This value is set to 5 when the parameter is not specified.
losttimes (Optional)	1-100	The number of missing Keep Alive in order to detect a network failure. This value is set to 2 when the parameter is not specified.
receivetimes (Optional)	1-100	The <i>number of receiving Keep Alive</i> after network failure in order to detect a network recovery. This value is set to 2 when the parameter is not specified.
activation (Optional)	1, 0	1: activate monitoring 0: inactivate monitoring Default value is 1. If the value set to 0, the other parameters are ignored. Then SD recording for network failure is stopped.

[Command examples]

http://192.168.0.10/cgi-bin/set_backup_schedule?backupfrom=20201224T090000Z&backupto=20201224T200000Z&interval=5&losttimes=2&receivetimes=2&fractionlost=25

[Sequence]



Note:

If a camera reboot during the monitoring period, the camera starts recording until it receive another PLAY request with sdbackup parameter.

8.7.3. Get backup schedule

[URL] /cgi-bin/get_backup_schedule
[Method] GET
[Access level] 1

[Command examples]
http://192.168.0.10/cgi-bin/get_backup_schedule

Response is shown below.

```
-----  
HTTP/1.1 200 OK[CR][LF]  
Content-type: text/plain[CR][LF]  
[CR][LF]  
backupfrom:20120201T120000Z [CR][LF]  
backupto:20120201T130000Z [CR][LF]  
interval:5 [CR][LF]  
losttimes:2 [CR][LF]  
receivetimes:2 [CR][LF]  
fractionlost: [CR][LF]  
activation:1 [CR][LF]  
-----
```

8.7.4. Forced backup

During the monitoring period, client can start/(stop) SD backup without detecting network failure. Recording stops when the monitoring ends.

[URL] /cgi-bin/force_backup?cmd=<Value>
[Method] GET
[Access level] 1

Parameter name	Value	Comments
cmd	start	Start recording
	stop	Stop recording

[Command examples]
http://192.168.0.10/cgi-bin/force_backup?cmd=start

8.7.5. Get Forced backup settings

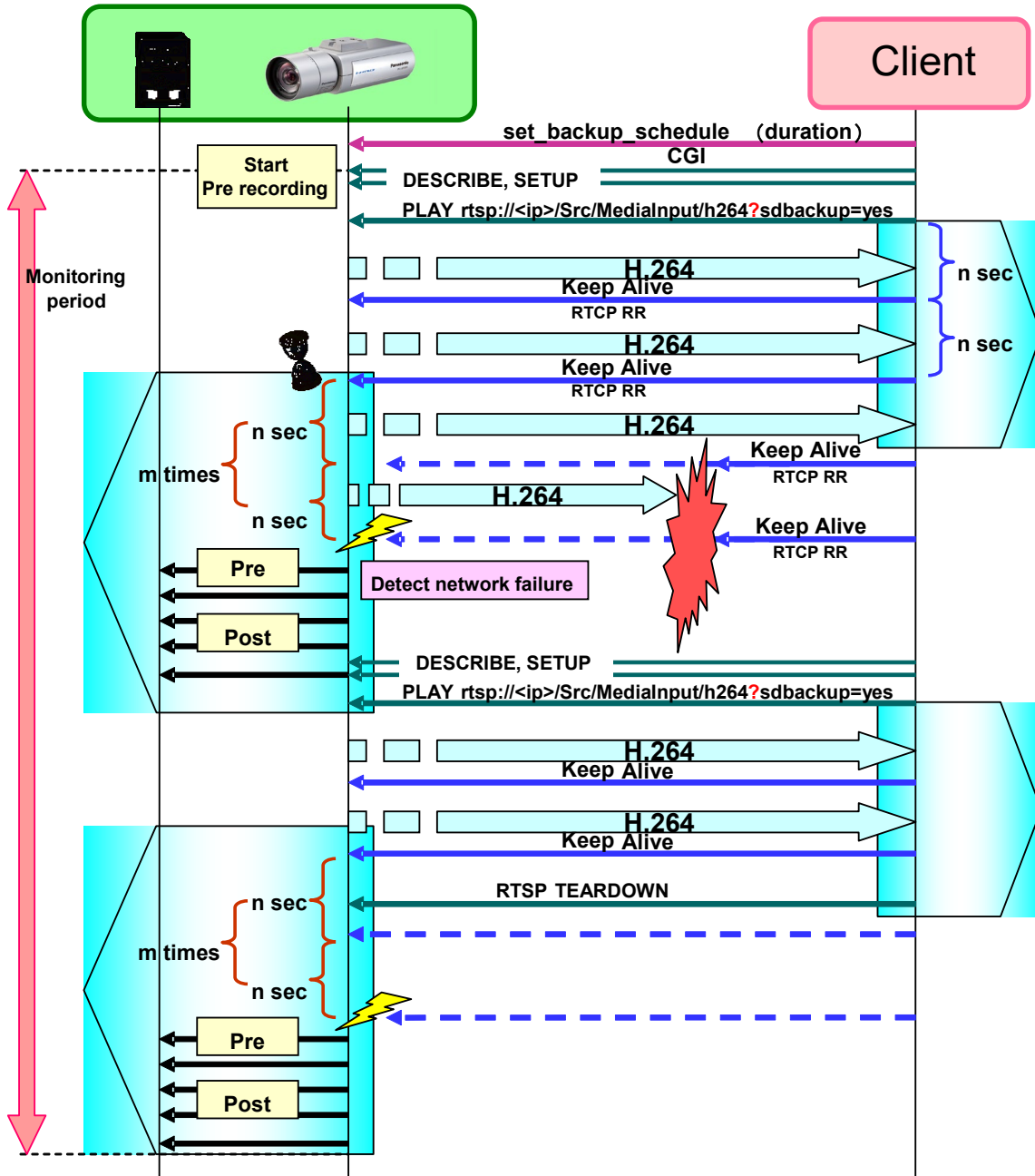
[URL] /cgi-bin/get_force_backup
[Method] GET
[Access level] 1

[Command examples]
http://192.168.0.10/cgi-bin/get_force_backup

Response is shown below.

```
-----  
HTTP/1.1 200 OK[CR][LF]  
Content-type: text/plain[CR][LF]  
[CR][LF]  
cmd:stop [CR][LF]  
-----
```

8.7.6. Sequence



9. General

9.1. Get product information

[URL] /cgi-bin/getinfo?FILE=1

[Method] GET

[Access level] 3

[Response data example]

```
-----  
<HTML>  
MAC=< Mac address >[CR][LF]  
VERSION=< Firmware version >[CR][LF]  
NAME=< Model name >[CR][LF]  
SDrec=< Recording status >[CR][LF]  
sAlarm=< Alarm status >[CR][LF]  
sAUX=< Aux status >[CR][LF]  
aEnable=< Audio unicast port number >[CR][LF]  
aEnc=< Audio encoder setup > [CR][LF]  
aBitrate=< Audio bit rate(G.726) >[CR][LF]  
aBitrate2=< Audio bit rate(G.711) >[CR][LF]  
aBitrate3=< Audio bit rate(AAC-LC) >[CR][LF]  
aInInterval=< Audio input interval >[CR][LF]  
aOutInterval=< Audio output interval >[CR][LF]  
aOutPort=< Audio output port >[CR][LF]  
aOutStatus=< Audio output status >[CR][LF]  
aOutUID=< Audio output UID >[CR][LF]  
ImageCaptureMode=< Image Capture Mode >[CR][LF]  
ratio=<Image ratio> [CR][LF]  
Maxfps=<Maximum frame rate> [CR][LF]  
StreamMode=< Stream mode >[CR][LF]  
Rotation=<Image rotation> [CR][LF]  
StreamEncode=<Stream(1) stream encode >  
StreamEncode_2=<Stream(2) stream encode >  
iTransmit_h264=< Stream(1) ON/OFF setting >  
sDelivery_h264=< Stream(1) setting >  
iBitrate_h264=< Stream(1) bitrate >  
iResolution_h264=< Stream(1) resolution >  
iQuality_h264=< Stream(1) quality >  
iMultiAuto_h264=<Stream(1) multicast auto start>  
iTransmit_mode=<Stream(1) priority>  
iSmartCoding=<Stream(1) smart coding>  
iTransmit_h264_2=< Stream(2) ON/OFF setting >  
sDelivery_h264_2=< Stream(2) setting >  
iBitrate_h264_2=< Stream(2) bitrate >  
iResolution_h264_2=< Stream(2)resolution >  
iQuality_h264_2=< Stream(2) quality >  
iMultiAuto_h264_2=<Stream(2) multicast auto start>  
iTransmit_mode_2=<Stream(2) priority>  
iSmartCoding_2=<Stream(2) smart coding>  
</HTML>  
-----
```

Parameter name	Response value	Comments
MAC		Mac address
VERSION		Software Version
SERIAL		Serial number
NAME		Product name e.g.)WV-S2531L.
iTransmit_h264	0, 1	Current value of the stream(1) setting 0: OFF, 1: ON
iTransmit_h264_2		Current value of the stream(2) setting
iTransmit_h264_3		Current value of the stream(3) setting
iTransmit_h264_4		Current value of the stream(4) setting
sDelivery_h264	uni, multi, uni_manual	Current value of stream(1) setting. uni : Unicast (Auto) multi : Multicast uni_manual : Unicast (Manual)
sDelivery_h264_2		Current value of Stream(2) setting.
sDelivery_h264_3		Current value of Stream(3) setting.
sDelivery_h264_4		Current value of Stream(4) setting.
iBitrate_h264	64, 128, 256, 384, 512, 768, 1024, 1536, 2048, 3072, 4096, 6144, 8192, 10240, 12288, 14336, 16384, 20480, 24576,	Current value of the Stream(1) bandwidth setting. 64 : 64kbps, 128 : 128 kbps, 256 : 256 kbps, 384: 384 kbps, 512: 512 kbps, 768: 768 kbps, 1024: 1024 kbps, 1536: 1536 kbps, 2048: 2048 kbps, 3072: 3072 kbps, 4096: 4096 kbps, 6144: 6144 kbps 8192: 8192 kbps, 10240: 10240 kbps, 12288: 12288 kbps 14336: 14336 kbps 16384: 16384 kbps 20480: 20480 kbps 24576: 24576 kbps
iBitrate_h264_2		Current value of the Stream(2) bandwidth setting.
iBitrate_h264_3		Current value of the Stream(3) bandwidth setting.
iBitrate_h264_4		Current value of the Stream(4) bandwidth setting.

iResolution_h264	3840 3072 2992 2560 2192, 2048 1920 1600 1280 800 640 400 320	Current value of the Stream(1) resolution setting. Resolution to be set (4:3) 320 : QVGA 400 : 400x300 640 : VGA 1280 : 1280 x 960 2048 : 2048 x 1536 800 800 x 600 1600: 1600x1200 2560: 2560x1920 3072: 3072x2304 Resolution to be set (16:9) 640 : 640 x 360 320 : 320 x 180 1280 : 1280 x 720 1920 : 1920 x 1080 2560: 2560x1440 3072: 3072x1728 3840: 3840x2160 Resolution to be set (1:1) 640 : 640 x 640 320 : 320 x 320 1280 : 1280 x 1280 2192 : 2192 x 2192 2992 : 2992 x 2992
iResolution_h264_2		Current value of the Stream(2) resolution setting.
iResolution_h264_3		Current value of the Stream(3) resolution setting.
iResolution_h264_4		Current value of the Stream(4) resolution setting.
iQuality_h264	fine, normal, low 0, 1, 2, 3, 4, 5,6, 7, 8, 9	Current value of the Stream(1) quality setting fine : Fine normal: Normal low : Low 0, 1, 2, 3, 4, 5, 6, 7, 8, 9 : 10 step setting when VBR
iQuality_h264_2		Current value of the Stream(2) quality setting
iQuality_h264_3		Current value of the Stream(3) quality setting
iQuality_h264_4		Current value of the Stream(4) quality setting
following parameters can be used for Multi-sensor models		
iMladd_cam1		Multicast address ch1
iMladd_cam2		Multicast address ch2
iMladd_cam3		Multicast address ch3
iMladd_cam4		Multicast address ch4
iMlport_cam1	(numerical value)	Multicast port number ch1
iMlport_cam2	(numerical value)	Multicast port number ch2
iMlport_cam3	(numerical value)	Multicast port number ch3
iMlport_cam4	(numerical value)	Multicast port number ch4
iTransmit_h264_cam2	0, 1	Current value of the stream(1) setting ch2 0: Off, 1:On
iTransmit_h264_cam3		Current value of the stream(1) setting ch3
iTransmit_h264_cam4		Current value of the stream(1) setting ch4
sDelivery_h264_cam2	uni, multi, uni_manual	Current value of H.264/265 stream(1) setting ch2. uni : Unicast (Auto) multi : Multicast uni_manual : Unicast (Manual)
sDelivery_h264_cam3	uni, multi, uni_manual	Current value of H.264/265 stream(1) setting ch3.
sDelivery_h264_cam4	uni, multi, uni_manual	Current value of H.264/265 stream(1) setting ch4.
iBitrate_h264_cam2		Current value of the stream(1) bandwidth setting ch2

iBitrate_h264_cam3		Current value of the stream(1) bandwidth setting ch3.
iBitrate_h264_cam4		Current value of the stream(1) bandwidth setting ch4.
iResolution_h264_cam2		Current value of the stream(1) resolution setting ch2.
iResolution_h264_cam3		Current value of the stream(1) resolution setting ch3.
iResolution_h264_cam4		Current value of the stream(1) resolution setting ch4.
iQuality_h264_cam2		Current value of the stream(1) quality setting ch2
iQuality_h264_cam3		Current value of the stream(1) quality setting ch3
iQuality_h264_cam4		Current value of the stream(1) quality setting ch4
iTransmit_h264_2_cam2	0, 1	Current value of the stream(2) setting ch2 0: Off, 1:On
iTransmit_h264_2_cam3		Current value of the H.264/265 stream(2) setting ch3
iTransmit_h264_2_cam4		Current value of the H.264/265 stream(2) setting ch4
sDelivery_h264_2_cam2	uni, multi, uni_manual	Current value of H.264/265 stream(2) setting ch2.
sDelivery_h264_2_cam3		Current value of H.264/265 stream(2) setting ch3.
sDelivery_h264_2_cam4		Current value of H.264/265 stream(2) setting ch4.
iBitrate_h264_2_cam2		Current value of the stream(2) bandwidth setting ch2
iBitrate_h264_2_cam3		Current value of the stream(2) bandwidth setting ch3.
iBitrate_h264_2_cam4		Current value of the stream(2) bandwidth setting ch4.
iResolution_h264_2_cam2		Current value of the stream(2) resolution setting ch2.
iResolution_h264_2_cam3		Current value of the stream(2) resolution setting ch3.
iResolution_h264_2_cam4		Current value of the stream(2) resolution setting ch4.
iQuality_h264_2_cam2		Current value of the stream(2) quality setting ch2
iQuality_h264_2_cam3		Current value of the stream(2) quality setting ch3
iQuality_h264_2_cam4		Current value of the stream(2) quality setting ch4
following parameters are equivalent to the response of "GetUID" (Refer to chapter 2.2.4)		
ImageCaptureMode		Current value of the Image capture mode setting
ratio		Aspect ratio
Maxfps		
StreamMode		1(fixed)
Rotation		
aEnable		Current value of audio mode setting
aEnc		Audio encoder setup
aBitrate		Current value of audio bit rate setting (G.726)
aBitrate2		Current value of audio bit rate setting (G.711)
aBitrate3		Current value of audio bit rate setting (AAC-LC)
aInInterval		Current value of audio input interval setting (from camera to PC)
aOutInterval		Current value of audio output interval setting (from PC to camera)
aOutPort		Current value of audio output port setting (from PC to camera)
aOutStatus		Status of audio output function
aOutUID		UID that is transmitting "audio output"
sAlarm		Alarm status (CH1)
sAlarm2		Alarm status (CH2)
sAlarm3		Alarm status (CH3)
sAlarm4		Alarm status (CH4)
SDrec		Status of SD card recording stream 1
SDrec2		Status of SD card recording stream 2
sAUX		AUX output status
StreamEncode		Encode setting of stream(1)
StreamEncode_2		Encode setting of stream(2)
StreamEncode_3		Encode setting of stream(3)
StreamEncode_4		Encode setting of stream(4)
iMultiAuto_h264		Multicast auto start stream(1)
iMultiAuto_h264_2		Multicast auto start stream(2)
iMultiAuto_h264_3		Multicast auto start stream(3)
iMultiAuto_h264_4		Multicast auto start stream(4)

iTransmit_mode		Stream(1) priority setting
iTransmit_mode_2		Stream(2) priority setting
iTransmit_mode_3		Stream(3) priority setting
iTransmit_mode_4		Stream(4) priority setting
iSmartCoding		Stream(1) Smartcoding setting
iSmartCoding_2		Stream(2) Smartcoding setting
iSmartCoding_3		Stream(3) Smartcoding setting
iSmartCoding_4		Stream(4) Smartcoding setting
iTransmit_mode_cam2		Stream(1) priority setting ch2
iTransmit_mode_cam3		Stream(1) priority setting ch3
iTransmit_mode_cam4		Stream(1) priority setting ch4
iSmartCoding_cam2		Stream(1) Smartcoding setting ch2
iSmartCoding_cam3		Stream(1) Smartcoding setting ch3
iSmartCoding_cam4		Stream(1) Smartcoding setting ch4
iTransmit_mode_2_cam2		Stream(2) priority setting ch2
iTransmit_mode_2_cam3		Stream(2) priority setting ch3
iTransmit_mode_2_cam4		Stream(2) priority setting ch4
iSmartCoding_2_cam2		Stream(2) Smartcoding setting ch2
iSmartCoding_2_cam3		Stream(2) Smartcoding setting ch3
iSmartCoding_2_cam4		Stream(2) Smartcoding setting ch4
Fisheye_ImageMode		Image capture mode of the Fish eye camera
Fisheye_UpsideDown		Ceiling or wall setting of the Fish eye camera
Fisheye_PTZ		PTZ enable or not enable of the Fish eye camera

9.2. Get capability

The meaning of each parameters are shown on the chapter that is related to the function. This chapter shows the example of capability information.

[URL] /cgi-bin/get_capability

[Method] POST/GET

[Access level] 3

[Response data example]

```
-----
common.capability_version=1.00
common.category=camera
video_server.basic.type=fixed
video_server.cam_ctrl.ptz.supported=no
...
video_server.peripheral.io.number=3
...
video_server.image.sensor.aspect_ratio=16_9
...
video_server.image.format=jpeg,mjpeg,h264,h264_cabac,h265
video_server.image.mode=2m_r16_9,2m_r16_9_60fps,3m
video_server.image.rotation.supported=yes
video_server.image.rotation.parameter=0,90,180,270
video_server.image.jpeg.resolution=2048x1536,1280x960,800x600,640x480,400x300,320x240,1920x1
...
video_server.image.mjpeg.resolution=2048x1536,1280x960,800x600,640x480,400x300,320x240,1920x
1080,1280x720,640x360,320x180
...
video_server.image.h264.resolution=2048x1536,1280x960,800x600,640x480,400x300,320x240,1920x1
080,1280x720,640x360,320x180
...
video_server.image.h264-4.resolution=640x480,400x300,320x240,640x360,320x180
...
video_server.image.h265.resolution=2048x1536,1280x960,800x600,640x480,400x300,320x240,1920x1
080,1280x720,640x360,320x180
...
video_server.image.h265-4.resolution=640x480,400x300,320x240,640x360,320x180
video_server.audio.audio_input.number=1
...
video_server.sdcard.supported=yes
...
video_server.network.nw_bandwidth=64,128,256,384,512,768,1024,2048,4096,6144,8192,10240,1536
0,20480,25600,30720,35840,40960,51200,unlimited
video_server.network.ipv6.supported=yes
video_server.network.https.supported=yes
video_server.vmd.supported=yes
video_server.meta.type=vmd,time,frame_time,audio_detect,audio,sdrec
video_server.smartcoding.supported=yes
...
video_server.alarm.get_io2.format=1,2,3
-----
```

9.3. Get data

9.3.1. Get setup data list

[URL] /cgi-bin/getdata or /cgi-bin/setdata

[Method] GET

[Access level] 1

[Example of the response]

The meaning of each parameters are shown on the chapter that is related to the function. This chapter shows other information.

```
CAMTITLE,"Camera"
TIMEDATE,"2007,1,1,3,2,39"
TIMEFORMAT,"4"
TIMEDISP,"24"
STIME,"0"
LED,"1"
TIMEADJUST,"1"
OSDPOSI,"ul"
.....
.....
```

Parameter name	Value	Comments
LED	1, 0	Link/Access LED 1: LED ON 0: LED OFF
AEVENT	1, 0	Alarm status update mode 0: Polling (30 sec) 1: Real time
AEVENTPORT	(number)	Alarm status port 1 to 65535
LIVEDISP	jpeg, jpeg_2 jpeg_3 h264 h264_2 h264_3 h264_4 multi_screen	Initial display image type jpeg: JPEG(1) jpeg_2:JPEG(2) jpeg_3:JPEG(3) h264:Stream(1) h264_2:Stream(2) h264_3:Stream(3) h264_4:Stream(4) multi_screen: Multi screen
SDREM	(number)	Available size of the SD memory card (KB)
SDTOTAL	(number)	Total size of the SD memory card (KB)
SDRECALMCH	(number)	Target Ch for saving images by alarm input
SDRECNAME	Characters	File name
SDRECINT	0.1, 0.2, 0.33, 0.5, 1	Frame rate 0.1: 0.1 fps 0.2: 0.2 fps 0.33: 0.33 fps 0.5: 0.5 fps 1: 1 fps

Parameter name	Value	Comments
SDRECNUM	10, 20, 30, 50, 100, 200, 300, 500, 1000, 2000, 3000, 5000	Number of images 10: 10 pics 20: 20 pics 30: 30 pics 50: 50 pics 100: 100 pics 200: 200 pics 300: 300 pics 500: 500 pics 1000: 1000 pics 2000: 2000 pics 3000: 3000 pics 5000: 5000 pics
SDRECRESOLUTION	640, 320, 1280, 2048 800, 1600 2560 3072 1920 3840 2048 2192 2816 2992	Resolution to be set (4:3) 640 : VGA 320 : QVGA 1280 : 1280 x 960 2048 : 2048 x 1536 800 800 x 600 1600: 1600x1200 2560: 2560x1920 3072: 3072x2304 Resolution to be set (16:9) 640 : 640 x 360 320 : 320 x 180 1280 : 1280 x 720 1920 : 1920 x 1080 2048 : 1920 x 1080 2560: 2560x1440 3072: 3072x1728 3840: 3840x2160 Resolution to set (1:1) 640 : 640 x 640 320 : 320 x 320 1280 : 1280 x 1280 2192 : 2192 x 2192 2992 : 2992 x 2992
LIVEINT	0.1, 0.2, 0.33, 0.5, 1, 2, 3, 5, 6, 10, 15, 30	Refresh interval (JPEG) 0.1: 0.1 fps 0.2: 0.2 fps 0.33: 0.33 fps 0.5: 0.5 fps 1: 1 fps 2: 2 fps 3: 3 fps 5: 5 fps 6: 6 fps 10: 10 fps 15: 15 fps 30: 30 fps
STABILIZER	1, 0	Stabilizer 1: ON, 0: OFF
FTPUSE	1, 0	FTP periodic transmission 1: ON, 0: OFF
FTPDIR	Characters	Directory name where the images are to be saved.
FTPNAME	Characters	File name of the image file to be transmitted

Parameter name	Value	Comments
FTPNAMEMDOE	fix, time	With time and date file name or fixed name fix: without time and date time: with time and date
FTPINT	1, 2, 3, 4, 5, 6, 10, 15, 20, 30, 60, 120, 180, 240, 300, 360, 600, 900, 1200,1800, 3600,5400, 7200, 10800, 14400, 21600, 43200, 86400	Interval for the FTP periodic transmission 1: 1 sec , 2: 2 sec, 3: 3 sec, 4: 4 sec, 5: 5 sec, 6: 6 sec 10: 10 sec, 15: 15 sec, 20: 20 sec, 30: 30 sec 60: 1 min, 120: 2 min, 180: 3 min, 240: 4 min 300: 5 min, 360: 6 min, 600: 10 min, 900: 15 min 1200: 20 min, 1800: 30 min, 3600: 1 hour 5400: 1.5 hours, 7200: 2 hours, 10800: 3 hours 14400: 4 hours, 21600: 6 hours, 43200: 12 hours 86400: 24 hours
FTPSIZE	640, 320	Image capture size for the FTP periodic transmission 640: VGA, 320: QVGA
HTTPALM	(number)	Alarm notification setup 96 , 64 , 32 , 128 :ON another number : OFF
HTTPALM2	(number)	Alarm notification setup 2
HTTPALM3	(number)	Alarm notification setup 3
HTTPALM4	(number)	Alarm notification setup 4
HTTPALM5	(number)	Alarm notification setup 5
HTTPALMURL	Characters	URL setup of alarm notification
HTTPALMURL2	Characters	URL setup of alarm notification 2
HTTPALMURL3	Characters	URL setup of alarm notification 3
HTTPALMURL4	Characters	URL setup of alarm notification 4
HTTPALMURL5	Characters	URL setup of alarm notification 5
HTTPALMUSER	Characters	Login name to server
HTTPALMUSER2	Characters	Login name to server 2
HTTPALMUSER3	Characters	Login name to server 3
HTTPALMUSER4	Characters	Login name to server 4
HTTPALMUSER5	Characters	Login name to server 5
PATROLSET	0, 1	Information of memorized patrol 0: Not memory 1: Memorized e.g.) 1000: The memorized patrol is only No.1. e.g.) 0110: The memorized patrols re No2 and No.3
STIMES_MON	1 to 12	Summer time auto setting Start time (month)
STIMES_WEEK	1 to 5	Summer time auto setting Start time (week)
STIMES_DOTW	0 to 6	Summer time auto setting Start time (week) 0: Sunday, 1: Monday,2: Tuesday, 3:Wednesday 4: Thursday, 5:Friday, 6 Saturday
STIMES_HOUR	1 to 12	Summer time auto setting Start time (hour)
STIMES_AMPM	0, 1	Summer time auto setting Start time (AM/PM) 0: AM, 1:PM
STIMEE_MON	1 to 12	Summer time auto settingEnd time (month)
STIMEE_WEEK	1 to 5	Summer time auto setting End time (week)
STIMEE_DOTW	0 to 6	Summer time auto setting End time (week) 0: Sunday, 1: Monday,2: Tuesday, 3:Wednesday 4: Thursday, 5:Friday, 6 Saturday
STIMEE_HOUR	1 to 12	Summer time auto setting End time (hour)
STIMEE_AMPM	0, 1	Summer time auto setting End time (AM/PM) 0: AM, 1:PM

9.3.2. Get setup data individually

[URL] /cgi-bin/getdata?req=<Value>,<Value>
 [Method] GET
 [Access level] 1

Parameter name	Value	Comments
req	H264MLAUTO, H264MLAUTO_2, H264MLAUTO_3, H264MLAUTO_4	Refer to chapter 2.9
	H264, H264BWC, H264SIZE, H264QUAL, H264FPRIORITY, H264NRFRAMERATE, H264RINT, H264MTD, H264MLADD1, H264MLADD2, H264MLADD3, H264MLADD4, H264MLPORT, H264MLTTL,	Refer to chapter 2.12.1
	H264_2, H264BWC_2, H264SIZE_2, H264QUAL_2, H264FPRIORITY_2, H264NRFRAMERATE_2, H264RINT_2, H264MTD_2, H264MLADD1_2, H264MLADD2_2, H264MLADD3_2, H264MLADD4_2, H264MLPORT_2, H264MLTTL_2,	Refer to chapter 2.12.2
	H264_3, H264BWC_3, H264SIZE_3, H264QUAL_3, H264FPRIORITY_3, H264NRFRAMERATE_3, H264RINT_3, H264MTD_3, H264MLADD1_3, H264MLADD2_3, H264MLADD3_3, H264MLADD4_3, H264MLPORT_3, H264MLTTL_3,	
	H264_4, H264BWC_4, H264SIZE_4, H264QUAL_4, H264FPRIORITY_4, H264NRFRAMERATE_4, H264RINT_4, H264MTD_4, H264MLADD1_4, H264MLADD2_4, H264MLADD3_4, H264MLADD4_4, H264MLPORT_4, H264MLTTL_4,	
	H264PROFILE, H264PROFILE_2, H264PROFILE_3, H264PROFILE_4	Refer to chapter 2.15.1
	LIVESIZE, LIVESIZE2, LIVESIZE3, LIVEQUAL, LIVEQUAL2, LIVEQUAL3,	Refer to chapter 2.16.1
	SMARTCODING, SMARTCODING_2, SMARTCODING_3, SMARTCODING_4, SMART_FACE, SMART_VIQS, SMART_VIQS_2	Refer to chapter 3.2
	AUDIO, AUDIOSENS, AUDIOENC, AUDIOINT, AUDIOOUTINT, AUDIOOUTPORT, AUDIOOUTSENS,	Refer to chapter 4.5
	ATRMIN, ATRMIN2, ATRMIN3, AINMODE, AINMODE2, AINMODE3, ATRMOUT, ATRMODE, AOUTMIDE, APULSEWIDE	Refer to chapter 7.1.2
	AAUDIO, AAUDIOOTH	Refer to chapter 7.47.5
	ACMD, ACMDPORT,	Refer to chapter 7.5
	RTSPPORT	Refer to chapter 11.3
VMDINFO	Refer to chapter 13.2	

[Command example]

Get setup value RTSP port

<http://192.168.0.10/cgi-bin/getdata?req=RTSPMODE,RTSPPORT>

Get setup value both the bandwidth and smart coding of Stream (1)

<http://192.168.0.10/cgi-bin/getdata?req=H264BWC,SMARTCODING>

9.4. Time & date setup

[URL] /cgi-bin/set_basic? [<Parameter name>=<Value>]

[Method] POST

[Access level] 1

Parameter name	Value	Comments	Parameter to get current setting (/cgi-bin/getdata)
set_year	2013 – 2035	Year (Manual setup) #Parameter range depends on model	TIMEDATE
set_month	1 – 12	Month (Manual setup)	
set_day	1 – 31	Date (Manual setup)	
set_hour	0 – 23	Hour (Manual setup)	
set_min	0 – 59	Minute (Manual setup)	
set_sec	0 – 59	Second (Manual setup)	
set_ampm	am, pm	AM or PM (Manual setup)	
time_display	12, 24, off	Time display format 12: 12-hours 24: 24-hours off: to hide time and date #When using this parameter to Multi-sensor models, it effects to all ch.	TIMEDISP
display_format	1,2,3,4,5	1:DD/MM/YYYY HH:MM:SS 2:MM/DD/YYYY HH:MM:SS 3:DD/Mmm/YYYY HH:MM:SS 4:YYYY/MM/DD HH:MM:SS 5:Mmm/DD/YYYY HH:MM:SS	TIMEFORMAT
set_time	1	Parameter is fixed as 1	-
display_place	ul, bl, uc ur, br, bc	OSD Position ul: Upper left bl: Lower left ur: Upper right br: Lower right uc: Upper canter bc: Lower center #When using this parameter to Multi-sensor models, it effects to all ch.	OSDPOSI
display_size	large, middle, small small2	Character size large : Large middle : Middle small : Small small2 : Small except image size is smaller than VGA. Otherwise, OSD size becomes middle.)This setting is applied to both time and camera title.	OSDSIZE
timezone	1 – 76	Time zone(*)	TIMEZONE
summer_time	0, 1	1: Applies summer time 0: OFF	STIME
The following parameters can be used for Multi-sensor models			
display_place1	ul, bl, ur, br, uc, bc	Time display position (ch1)	OSDPOSI
display_place2	ul, bl, ur, br, uc, bc	Time display position (ch2).	OSDPOSI_CH2

Parameter name	Value	Comments	Parameter to get current setting (/cgi-bin/getdata)
display_place3	ul, bl, ur, br, uc, bc	Time display position (ch3)	OSDPOSI_CH3
display_place4	ul, bl, ur, br, uc, bc	Time display position (ch4)	OSDPOSI_CH4
timeonoff_display1	0, 1	Time display on/off (ch1)	TIMEONOFFDISP_CH1
timeonoff_display2	0, 1	Time display on/off (ch2)	TIMEONOFFDISP_CH2
timeonoff_display3	0, 1	Time display on/off (ch3)	TIMEONOFFDISP_CH3
timeonoff_display4	0, 1	Time display on/off (ch4)	TIMEONOFFDISP_CH4

[Command examples]

Change the date and time to 10/4/2020 17:20:20 (24-hours)

http://192.168.0.10/cgi-bin/set_basic?set_year=2020&set_month=10&set_day=4&set_hour=17&set_min=20&set_sec=20&time_display=24&display_place=ul&set_time=1

Change the date and time to 10/4/2020 5:20:20PM (12-hours)

http://192.168.0.10/cgi-bin/set_basic?set_year=2020&set_month=10&set_day=4&set_hour=5&set_min=20&set_sec=20&set_ampm=pm&time_display=12&display_place=ul&set_time=1

Change the time zone to "(GMT-04:00) Atlantic time(Canada)".

<http://192.168.0.10/cgi-bin/time?timezone=17>

Applies summer time

http://192.168.0.10/cgi-bin/set_basic?summer_time=1

(*) About the time zone Value

- <option value="1">(GMT-12:00) Eniwetok, Kwajalein</option>
- <option value="2">(GMT-11:00) Midway Island, Samoa</option>
- <option value="3">(GMT-10:00) Hawaii</option>
- <option value="4">(GMT-09:00) Alaska</option>
- <option value="5">(GMT-08:00) Pacific Time (US & Canada); Tijuana</option>
- <option value="6">(GMT-07:00) Arizona</option>
- <option value="7">(GMT-07:00) Mountain Time (US & Canada)</option>
- <option value="8">(GMT-06:00) Saskatchewan</option>
- <option value="9">(GMT-06:00) Mexico City</option>
- <option value="10">(GMT-06:00) Central America</option>
- <option value="11">(GMT-06:00) Central Time (US & Canada)</option>
- <option value="12">(GMT-05:00) Indiana (East)</option>
- <option value="13">(GMT-05:00) Bogota, Lima, Quito</option>
- <option value="14">(GMT-05:00) Eastern Time (US & Canada)</option>
- <option value="15">(GMT-04 :00) La Paz</option>
- <option value="15">(GMT-04 :30) Caracas</option>
- <option value="16">(GMT-04:00) Santiago</option>
- <option value="17">(GMT-04:00) Atlantic Time (Canada)</option>
- <option value="18">(GMT-03:30) Newfoundland</option>
- <option value="19">(GMT-03:00) Greenland</option>
- <option value="20">(GMT-03:00) Buenos Aires, Georgetown</option>
- <option value="21">(GMT-03:00) Brasilia</option>
- <option value="22">(GMT-02:00) Mid-Atlantic</option>
- <option value="23">(GMT-01:00) Azores</option>
- <option value="24">(GMT-01:00) Cape Verde Is.</option>
- <option value="25">(GMT) Casablanca, Monrovia</option>
- <option value="26">(GMT) Greenwich Mean Time : Dublin, Edinburgh, Lisbon, London</option>
- <option value="27">(GMT+01:00) Amsterdam, Berlin, Bern, Rome, Stockholm, Vienna</option>
- <option value="28">(GMT+01:00) Sarajevo, Skopje, Sofija, Vilnius, Warsaw, Zagreb</option>
- <option value="29">(GMT+01:00) Brussels, Copenhagen, Madrid, Paris</option>
- <option value="30">(GMT+01:00) Belgrade, Bratislava, Budapest, Ljubljana, Prague</option>

<option value="31">(GMT+01:00) West Central Africa</option>
<option value="32">(GMT+02:00) Athens, Istanbul, Minsk</option>
<option value="33">(GMT+02:00) Jerusalem</option>
<option value="34">(GMT+02:00) Cairo</option>
<option value="35">(GMT+02:00) Harare, Pretoria</option>
<option value="36">(GMT+02:00) Bucharest</option>
<option value="37">(GMT+02:00) Helsinki, Riga, Tallinn</option>
<option value="38">(GMT+03:00) Kuwait, Riyadh</option>
<option value="39">(GMT+03:00) Nairobi</option>
<option value="40">(GMT+03:00) Baghdad</option>
<option value="41">(GMT+03:00) Moscow, St. Petersburg, Volgograd</option>
<option value="42">(GMT+03:30) Tehran</option>
<option value="43">(GMT+04:00) Abu Dhabi, Muscat</option>
<option value="44">(GMT+04:00) Baku, Tbilisi, Yerevan</option>
<option value="45">(GMT+04:30) Kabul</option>
<option value="46">(GMT+05:00) Islamabad, Karachi, Tashkent</option>
<option value="47">(GMT+05:00) Ekaterinburg</option>
<option value="48">(GMT+05:30) Calcutta, Chennai, Mumbai, New Delhi</option>
<option value="76">(GMT+05:30) Sri Jayawardenepura</option>
<option value="49">(GMT+05:45) Kathmandu</option>
<option value="50">(GMT+06:00) Astana, Dhaka</option>
<option value="51">(GMT+06:00) Almaty, Novosibirsk</option>
<option value="53">(GMT+06:30) Rangoon</option>
<option value="54">(GMT+07:00) Krasnoyarsk</option>
<option value="55">(GMT+07:00) Bangkok, Hanoi, Jakarta</option>
<option value="56">(GMT+08:00) Irkutsk, Ulaan Bataar</option>
<option value="57">(GMT+08:00) Kuala Lumpur, Singapore</option>
<option value="58">(GMT+08:00) Perth</option>
<option value="59">(GMT+08:00) Taipei</option>
<option value="60">(GMT+08:00) Beijing, Chongqing, Hong Kong, Urumqi</option>
<option value="61">(GMT+09:00) Seoul</option>
<option value="62">(GMT+09:00) Yakutsk</option>
<option value="63">(GMT+09:00) Osaka, Sapporo, Tokyo</option>
<option value="64">(GMT+09:30) Adelaide</option>
<option value="65">(GMT+09:30) Darwin</option>
<option value="66">(GMT+10:00) Vladivostok</option>
<option value="67">(GMT+10:00) Canberra, Melbourne, Sydney</option>
<option value="68">(GMT+10:00) Guam, Port Moresby</option>
<option value="69">(GMT+10:00) Brisbane</option>
<option value="70">(GMT+10:00) Hobart</option>
<option value="71">(GMT+11:00) Magadan, Solomon Is., New Caledonia</option>
<option value="72">(GMT+12:00) Auckland, Wellington</option>
<option value="73">(GMT+12:00) Fiji, Kamchatka, Marshall Is.</option>
<option value="74">(GMT+13:00) Nukualofa</option>

9.5. Camera title setup

[URL] /cgi-bin/set_basic? [<Parameter name>=<Value>]

[Method] POST

[Access level] 1

Parameter name	Value	Comments	Parameter to get current setting (/cgi-bin/getdata)
cam_title	0-20 characters	Camera title in the status display area	CAMTITLE
camid_display	0, 1	Display the camera title on the image 0: OFF , 1: ON #When using this parameter to Multi-sensor models, it effects to all ch.	OSDNAMEDISP
camid	1-16 characters	Camera title on the image Transmit "+" in case of setting a blank column	OSDNAME
camid_display_place	ul, bl, ur, br, uc, bc	Camera ID display position ul: Upper left bl: Lower left ur: Upper right br: Lower right uc: Upper canter bc: Lower center	CAMIDPOSI
display_size	large, middle, small, small2	Character size large : Large middle : Middle small : Small small2 :Small except image size is smaller than VGA. Otherwise, OSD size becomes middle.)This setting is applied to both time and camera title	OSDSIZE
The following parameters can be used for Multi-sensor models			
camid_display1	0, 1	Display the camera title on the image (ch1) 0: OFF, 1: ON	OSDNAMEDISP
camid_display2	0, 1	Display the camera title on the image (ch2)	OSDNAMEDISP_CH2
camid_display3	0, 1	Display the camera title on the image (ch3)	OSDNAMEDISP_CH3
camid_display4	0, 1	Display the camera title on the image (ch4)	OSDNAMEDISP_CH4
camid2	1-16 characters	Ch2 Camera title on the image	OSD2NAME
camid3	1-16 characters	Ch3 Camera title on the image	OSD3NAME
camid4	1-16 characters	Ch4 Camera title on the image	OSD4NAME
camid_place	ul, bl, ur, br, uc, bc	Camera ID display position (ch1)	CAMIDPOSI
camid2_place	ul, bl, ur, br, uc, bc	Camera ID display position (ch2)	CAMIDPOSI_CH2
camid3_place	ul, bl, ur, br, uc, bc	Camera ID display position (ch3)	CAMIDPOSI_CH3
camid4_place	ul, bl, ur, br, uc, bc	Camera ID display position (ch4)	CAMIDPOSI_CH4

[Command examples]

Change camera title in the status display area to "THE FRONT DOOR"

http://192.168.0.10/cgi-bin/set_basic?cam_title=THE FRONT DOOR

Change camera title on the screen to "THE FRONT DOOR", and display the title.

http://192.168.0.10/cgi-bin/set_basic?camid_display=1&camid=THE FRONT DOOR

9.6. Initialization

[Important]

- When the camera (encoder unit) described below receives this command from the Internet Explorer or the other browsers, the response code from the camera (encoder unit) becomes "400 Bad request". This is specifications to protect a camera from an unnecessary attack via network.

[URL] /cgi-bin/initial?cmd=<Value>

[Method] POST/GET

[Access level] 1

Parameter name	Value	Comments
cmd	data, html, all, reset, restart,	data :Initialize camera setup data (Except network and preset setup data) html :Initialize HTML data all :Initialize setup data and HTML data reset :Restart the camera restart :Position refresh

[Command examples]

Initialize setup data and HTML data

<http://192.168.0.10/cgi-bin/initial?cmd=all>

Restart

<http://192.168.0.10/cgi-bin/initial?cmd=reset>

9.7. Add hidden items to setup menu

[URL] /cgi-bin/setup_menu_disp?[<Parameter name>=<Value>]

[Method] POST/GET

[Access level] 1

Parameter name	Value	Comments
25fps	0, 1	25fps/50fps mode display 0 : No display 1 : Display

[Note]

As for PTZ models, the following switch will make the camera transmit out of focus image for about a minute.

[1] Change from 30fps/60fps mode to 25fps/50fps mode

[2] Change from 25fps/50fps mode to 30fps/60fps mode

9.8. Force PoE injector (60W power supply) mode setup

[URL] /cgi-bin/poe_ctrl?[<Parameter name>=<Value>]

[Method] POST/GET
 [Access level] 1

Parameter name	Value	Comments
mode	on, normal	on: force PoE injector mode normal : detect power source and set appropriate mode

[Command example]
 Set force PoE injector mode
http://192.168.0.10/cgi-bin/poe_ctrl?mode=on

[Note]
 In using force PoE injector mode, please make it sure the camera is connected to PoE injector which supports 60W power supply.

9.9. Scope and configurable values for image quality

[URL] /cgi-bin/get_value_range
 [Method] GET/POST
 [アクセスレベル] 1

Parameter name	value	Comments
BRIGHTNESS	0-255	Brightness
AGC	0-11	Maximum gain
CHROMA	0-255	Chroma level
APERTURE	0-31	Sharpness level
DNR_DETAIL	0-255	Digital noise reduction
MEGASD	Unavailable to set : empty field Avialiable to set : 0,1 In case of 60/50fps mode,this parameter is unavailable to set	Super dynamic
SD_LEVEL	Unavailable to set : empty field Avialiable to set : 0~31 ①In case of 60/50fps mode,this parameter is unavailable to set ②Cannot be set when Super Dynamic is On	level
BLC	Unavailable to set : empty field Avialiable to set : 0,1,2 ①Cannot be set when Intelligent Auto is On②Cannot be set when Super Dynamic is Off	Backlight / strong light correction

Parameter name	value	Comments
BLC_LEVEL	Unavailable to set : empty field Available to set : 0-31 ①Cannot be set when Super Dynamic is On. ②Can be set only when backlight compensation is set	Backlight compensation level
HLCLEVEL	Unavailable to set : empty field Available to set : 0-31 ①Cannot be set when Super Dynamic is On. ②Can be set only when strong light compensation is set	Stronglight compensation level
BLCMASK	Unavailable to set : empty field Available to set : start,end,reset,set Cannot be set when Super Dynamic is On	Mask area setting
ALCELC	①Value difference depending on the imaging mode (30 / 15fps, 60fps, 25 / 12.5fps, 50fps) <ul style="list-style-type: none"> ▪ Difference in fixed shutter value ▪ In the case of 25, 50, 12.5, flickerless 60Hz cannot be set. ②Fixed shutter cannot be set when Super Dynamic is on. ③ELC cannot be set when Super Dynamic is on.	Light intensity control mode

Parameter name	value	Comments
SENSITIVITY	<p>①Value difference depending on the imaging mode (30 / 15fps, 60fps, 25 / 12.5fps, 50fps)</p> <p>②Value difference due to super dynamic On / Off. When On, 1/2000 and 1/4000 cannot be set</p> <p>③16_30, maximum 16/30s 10_30, maximum 10/30s 6_30, maximum 6/30s 4_30, maximum 4/30s 2_30, maximum 2/30s 1_30, maximum 1/30s 3_120, maximum 3/120s 2_100, maximum 2/100s 2_120, maximum 2/120s 1_100, maximum 1/100s 1_120, maximum 1/120s 1_250, maximum 1/250s 1_500, maximum 1/500s 1_1000, maximum 1/1000s 1_2000, maximum 1/2000s 1_4000, maximum 1/4000s 1_10000, maximum 1/10000s</p> <p>④Restrictions due to light intensity control mode</p> <ul style="list-style-type: none"> ▪ For flickerless 60Hz: 1 / 250s, 1 / 500s, 1 / 1000s, 1 / 2000s, 1 / 4000s cannot be set. ▪ For flickerless 50Hz: 1 / 250s, 1 / 500s, 1 / 1000s, 1 / 2000s, 1 / 4000s cannot be set. 	Maximum exposure time
ALC_ELC_SPEED	0-31	Light intensity adjustment speed
BW	off,auto	Black and white switching
BWLEVEL	<p>Unavailable to set : empty field</p> <p>Available to set : 0,1,2,3</p> <ul style="list-style-type: none"> ▪ It may not be supported depending on the model 	Black and white switching-level

Parameter name	value	Comments
BWTIME	Unavailable to set : empty field This partameter can be set when black-and-white switching set as below <ul style="list-style-type: none"> · Auto1(IR Light Off)／Auto2(IR Light On)／Auto3(SCC) · Auto1(Normal)／Auto2(IR Light)／Auto3(SCC) 	Black and white switching-Switching time
IRLED	Unavailable to set : empty field This partameter can be set when black-and-white switching set as below <ul style="list-style-type: none"> · On(IR Light On)／Auto2(IR Light On) 	IR Light Irradiation intensity
IRLEDCTRL	Unavailable to set : empty field This partameter can be set when black-and-white switching set as below <ul style="list-style-type: none"> · On(IR Light On)／Auto2(IR Light On) 	IR Light Suppression of overexposure
WHITEBAL	awc,atw1,atw2	White balance
RVOL	0-255	R volume
BVOL	0-255	B volume
MASKAREA_WB_16	0x000000000000-0xFFFFFFFFFFFF	Mask area setting
WB_SPEED	0-31	Speed
AUTO_ADJUST	0,1	Intelligent auto
FACE_PRIORITY_LEVEL	Unavailable to set : empty field Avialiable to set : 0-255 Settings cannot be changed when Intelligent Auto is Off	Face priority level (brightness)
MOTION_PRIORITY_LEVEL	Unavailable to set : empty field Avialiable to set : 0-255 Settings cannot be changed when Intelligent Auto is Off	Movement priority level (shutter time)
CONTRAST_AUTO	Unavailable to set : empty field Avialiable to set : 0,1 Settings cannot be changed when Intelligent Auto is Off	Automatic contrast adjustment
CONTRAST_LEVEL	0-255	Contrast intensity

Parameter name	value	Comments
DARKCOMP	0-255	Dark area correction
HIGHLIGHT_REVISE_LEVEL	0-255	Bright area correction
FOG	Unavailable to set : empty field Avialiable to set : 0,1 Cannot be set when automatic contrast adjustment is on	Fog correction
FOGLEVEL	Unavailable to set : empty field Avialiable to set : 0-255 Cannot be set when fog correction is Off	Level
PEDESTAL	0-255	Pedestal level

Example)

http://192.168.0.10/cgi-bin/get_value_range

10. User Management

10.1. Administrator registration

At the time of first access to the camera (or at the time of initialization), no administrator is registered. Administrator must be registered on camera's web or following CGI.

[Important]

When the camera described below receives this command from the Internet Explorer or the other browsers, the response code from the camera becomes "400 Bad request".

This is specifications to protect a camera from an unnecessary attack via network.

[URL] [/cgi-bin/reg_admin?name=<Value>&password=<Value>&repassword=<Value>](#)

[Method] POST

[Access level] no access level and no authentication

Parameter name	Value	Comments
Name	Characters	name: 1-32 characters *BASE64 encoded
Password	Characters	password: 8-32 characters that must include the number and character. * BASE64 encoded
repassword	Characters	repassword *BASE64 encoded

[Response]

	When no administrator is registered	When administrator is registered
/cgi-bin/reg_admin (no parameter)	Reply [200 OK] Content-type: text/plain Content-Length: xx Not Registered	Reply [503] (Service Unavailable)
/cgi-bin/reg_admin (parameter not enough)	Reply [200 OK] Content-type: text/plain Content-Length: xx Parameter error	
/cgi-bin/reg_admin (parameter is error)	Reply [200 OK] Content-type: text/plain Content-Length: xx Invalid value	
/cgi-bin/reg_admin (succeeded)	Reply [200 OK] Content-type: text/plain Content-Length: xx Completion of registration	

10.2. User authentication

Up to 24 users can be registered.

[Important]

When the camera described below receives this command from the Internet Explorer or the other browsers, the response code from the camera becomes “400 Bad request”.

This is specifications to protect a camera from an unnecessary attack via network.

10.2.1. User registration

[URL] [/cgi-bin/reg_user? \[<Parameter name>=<Value>\]](#)

[Method] POST

[Access level] 1

Parameter name	Value	Comments	Parameter to get current setting (/cgi-bin/getdata)
user	0, 1	User authentication ON/OFF 0: OFF, 1: ON	UAUTH
name	Characters	User name 1 – 32 characters #This parameter can't be omitted when registering the user.	UNAME
password	Characters	Password 8 – 32 characters #This parameter can't be omitted when registering the user.	-
repassword	Characters	Password 8 – 32 characters #This parameter can't be omitted when registering the user.	-
access_level	1, 2, 3	Access level of the user 1: Administrator 2: Camera control 3: Live only #This parameter can't be omitted when registering the user.	

[Command examples]

User authentication ON.

http://192.168.0.10/cgi-bin/reg_user?user=1

Register (name: user1, Password: Password1, Access level: Administrator)

http://192.168.0.10/cgi-bin/reg_user?name=user1&password=Password1&repassword=Password1&access_level=1

User authentication ON, and register(name: user2, Password: Password2, Access level: Camera control)

http://192.168.0.10/cgi-bin/reg_user?user=1&name=user2&password=Password2&repassword=Password2&access_level=2

10.2.2. Delete the user

[URL] [/cgi-bin/del_user?name=<Value>](#)

[Method] POST

[Access level] 1

Parameter name	Value	Comments
name	Characters	User name

[Command examples]

Delete 'user1'

http://192.168.0.10/cgi-bin/del_user?name=user1

10.3. Host authentication

- Up to 24 IP addresses can be registered.
- Before configuring the host authentication, it is necessary to register IP addresses of the PCs to be allowed to access the camera and determine their access levels. If "ON" is selected for "Host authentication" before registering the hosts (IP addresses), it will be impossible to access the camera.

[Important]

- When the camera described below receives this command from the Internet Explorer or the other browsers, the response code from the camera becomes "400 Bad request".

This is specifications to protect a camera from an unnecessary attack via network.

10.3.1. IP address registration

[URL] [/cgi-bin/reg_host? \[<Parameter name>=<Value>\]](#)

[Method] POST

[Access level] 1

Parameter name	Value	Comments	Parameter to get current setting (/cgi-bin/getdata)
host	0, 1	Host authentication ON/OFF 0: OFF, 1: ON	HAUTH
host_addr	(IP address) or (IP address) / mask_length	IP address #This parameter can't be omitted when registering the host.	HADD
access_level	1, 2, 3	Access level of the user 1: Administrator 2: Camera control 3: Live only #This parameter can't be omitted when registering the host.	

[Command examples]

Host authentication ON.

http://192.168.0.10/cgi-bin/reg_host?host=1

Register the following IP address. (IP address: 192.168.0.99, Access level: Administrator)

http://192.168.0.10/cgi-bin/reg_host?host_addr=192.168.0.99&access_level=1

Host authentication: ON and register (IP address: 192.168.0.1/24, Access level: Camera control)
IP address between '192.168.0.1' and '192.168.0.255' can access

http://192.168.0.10/cgi-bin/reg_host?host=1&host_addr=192.168.0.1/24&access_level=2

10.3.2. Delete the IP address for the host authentication

[URL] [/cgi-bin/del_host?host_addr=<Value>](#)

[Method] POST

[Access level] 1

Parameter name	Value	Comments
host_addr	<IP address>	IP address to be deleted

[Command examples]

Delete '192.168.0.99'

http://192.168.0.10/cgi-bin/del_host?host_addr=192.168.0.99

11. Network setup

11.1. Network setup

11.1.1. Network setup

[Important]

- When the camera (encoder unit) described below receives this command from the Internet Explorer or the other browsers, the response code from the camera (encoder unit) becomes "400 Bad request". This is specifications to protect a camera from an unnecessary attack via network.

[URL] /cgi-bin/network? [<Parameter name>=<Value>]

[Method] POST

[Access level] 1

Parameter name	Value	Comments	Parameter to get current setting (/cgi-bin/getdata)
dhcp	0, 1, 2, 3	Network setting 0: Static 1: DHCP 2: Auto(AutoIP) 3: Auto(Advanced)	DHCP or NW
IP_addr1	0-255	IP address 1 st octet	EIP1
IP_addr2	0-255	IP address 2 nd octet	EIP2
IP_addr3	0-255	IP address 3 rd octet	EIP3
IP_addr4	0-255	IP address 4 th octet	EIP4
netmask1	0-255	Net mask 1 st octet	EMASK1
netmask2	0-255	Net mask 2 nd octet	EMASK2
netmask3	0-255	Net mask 3 rd octet	EMASK3
netmask4	0-255	Net mask 4 th octet	EMASK4
gateway1	0-255	Default gateway 1 st octet	EDGW1
gateway2	0-255	Default gateway 2 nd octet	EDGW2
gateway3	0-255	Default gateway 3 rd octet	EDGW3
gateway4	0-255	Default gateway 4 th octet	EDGW4
port	1-65535	HTTP port number	HTTPPORT
speed	1, 2, 3, 4,5	Line speed 1: Auto 2: 100Mbps full-duplex 3: 100Mbps half-duplex 4: 10Mbps full-duplex 5: 10Mbps half-duplex	SPEED
dns	manual, auto	DNS server address manually or automatically. Manual: Manual auto: Auto	DNS
pri_server1	0-255	Primary DNS address 1 st octet	PRISRV1
pri_server2	0-255	Primary DNS address 2 nd octet	PRISRV2
pri_server3	0-255	Primary DNS address 3 rd octet	PRISRV3
pri_server4	0-255	Primary DNS address 4 th octet	PRISRV4
sec_server1	0-255	Secondary DNS address 1 st octet	SECSRV1
sec_server2	0-255	Secondary DNS address 2 nd octet	SECSRV2
sec_server3	0-255	Secondary DNS address 3 rd octet	SECSRV3
sec_server4	0-255	Secondary DNS address 4 th octet	SECSRV4
pri_server	(Ipv4 address) or (Ipv6 address)	Primary DNS address	PRISRV

Parameter name	Value	Comments	Parameter to get current setting (/cgi-bin/getdata)
sec_server	(Ipv4 address) or (Ipv6 address)	Secondary DNS address	SECSRV
ip6_auto	0, 1	Manual (Ipv6) 0: ON (Manual) 1: OFF (Auto)	IP6_AUTO
ip6_addr	(Ipv6 address)	IP address (Ipv6)	IP6
sub_prefix	0 to 128	Sub prefix	
ip6_gateway	(Ipv6 address)	Default gateway (Ipv6)	IP6_DGW
ip6_dhcp	0, 1	Ipv6 DHCP 0 : Off, 1: On	IP6_DHCP
ip6_pri_server	(Ipv6 address)	Primary DNS address (Ipv6)	PRISRV_V6
ip6_sec_server	(Ipv6 address)	Secondary DNS address (Ipv6)	SECSRV_V6

[Command examples]

Change DHCP to ON

<http://192.168.0.10/cgi-bin/network?dhcp=1>

Change IP address and Net mask and Default gateway, IP address:192.168.0.30,

Net mask: 255.255.255.128, Default gateway: 192.168.0.50

http://192.168.0.10/cgi-bin/network?IP_addr1=192&IP_addr2=168&IP_addr3=0&IP_addr4=30&netmask1=255&netmask2=255&netmask3=255&netmask4=128&gateway1=192&gateway2=168&gateway3=0&gateway4=50

[Note]: IP address, subnet mask and default gateway should be set at the same time.

Change HTTP port number to 8080.

<http://192.168.0.10/cgi-bin/network?port=8080>

11.1.2. Apply the change of IP address immediately

The IP address change made through the command indicated in the 11.1.1 will not be applied unless the camera is restarted.

Please use the command below if the change needs to be applied immediately.

[URL] [/cgi-bin/net_notice](#)

[Method] POST

[Access level] 1

11.1.3. Capability information

CGI: /cgi-bin/get_capability

[Ipv6]

[video_server.network.ipv6.supported=<Value>](#)

Parameter name	Value	Comments
supported	yes, no	Ipv6 supported or not supported

[HTTPS]

[video_server.network.https.supported=<Value>](#)

Parameter name	Value	Comments
supported	yes, no	HTTPS(SSL) function supported or not supported.

11.2. Total bandwidth setup

11.2.1. Total bandwidth setup

[URL] /cgi-bin/set_bandwidth?[<Parameter name>=<Value>]
[Method] POST
[Access level] 1

Parameter name	Value	Comments	Parameter to get current setting (/cgi-bin/getdata)
bandwidth	0, 64,128,256,384, 512,768,1024, 2048,4096,6144, 8192,10240, 12288,15360, 20480,25600, 30720,35840, 40960,51200 61440,81920, 102400,153600	Total bit rate 0: Unlimited, 64: 64 kbps ~153600: 153600 kbps	BWC

[Command examples]

Change total bit rate setup to 3072kbps

http://192.168.0.10/cgi-bin/set_bandwidth?bandwidth=30720

11.2.2. Capability information

CGI: /cgi-bin/get_capability

[video_server.network.nw_bandwidth=<Value>](#)

Parameter name	Value	Comments
nw_bandwidth	64, 128, 256, 384, 512, 768, 1024, 2048, 4096,6144,8192,10240, 12288,15360, 20480, 25600, 30720, 35840, 40960, 51200, 61440, 81920, 102400 153600, unlimited	Supported value of the total bandwidth setting. The value is divided by a comma. e.g.) 64,128,256,512,1024,2048,4096,unlimited

11.3. RTSP setup

[URL] /cgi-bin/set_rtsp? [<Parameter name>=<Value>]

[Method] POST/GET

[Access level] 1

Parameter name	Value	Comments	Parameter to get current setting (/cgi-bin/getdata)
rtsp_port	1 to 65535 *Except 20, 21, 23, 25, 42, 53, 67, 68, 69, 80, 110, 123, 161, 162, 443, 995, 10669, 10670, 59000 to 61000	RTSP port number default : 554	RTSPPORT

[Command example]

Mode : RTSP port number : 554

http://192.168.0.10/cgi-bin/set_rtsp?rtsp_port=554

11.4. Set limit RTP packet size/HTTP max segment size

[Important]

- When the camera (encoder unit) described below receives this command from the Internet Explorer or the other browsers, the response code from the camera (encoder unit) becomes "400 Bad request".

This is specifications to protect a camera from an unnecessary attack via network.

[URL] /cgi-bin/network? [<Parameter name>=<Value>]

[Method] POST/GET

[Access level] 1

Parameter name	Value	Comments	Parameter to get current setting (/cgi-bin/getdata)
rtp_packet_max	1500, 1280	Max RTP packet size 1500: Unlimited(1500byte) 1280: Limited(1280byte)	RTPSIZE
mss	1460, 1280, 1024	HTTP max segment size (MSS) 1460: Unlimited(1460byte) 1280: Limited(1280byte) 1024: Limited(1024byte)	MSS

[Command example]

Set Max RTP packet size: 1280byte

http://192.168.0.10/cgi-bin/network?rtp_packet_max=1280

11.5. FTP setup

11.5.1. FTP server setup

[URL] /cgi-bin/set_ftp? [<Parameter name>=<Value>]

[Method] POST

[Access level] 1

Parameter name	Value	Comments	Parameter to get current setting (/cgi-bin/getdata)
server_addr	Characters	FTP server address (IP address or host name)	FTPSRV
Username	Characters	User name to login the FTP server	FTPUSER
password	Characters	Password for username	-
port_num	1 to 65535	A control port number to be used for the FTP server	FTPCPORT
mode	active, passive	FTP mode active : Active mode passive : Passive mode	FTPMODE

[Command example]

FTP server address: 192.168.0.22, User name: user1, Password: password1, port number: 21, FTP mode: passive

http://192.168.0.10/cgi-bin/set_ftp?server_addr=192.168.0.22&username=user1&password=password1&port_num=21&mode=passive

11.5.2. Image FTP transmission

[URL] /cgi-bin/jpeg_alarm? [<Parameter name>=<Value>]
 [Method] POST
 [Access level] 1

Parameter name	Value	Comments	Parameter to get current setting (/cgi-bin/getdata)
ftp_alarm	0, 1	Alarm image FTP transmission 0: OFF (not use the function) 1: ON (use the function)	AFTPUSE
at_directory	Characters *) 1 – 256 characters	The directory name where the alarm images are to be saved. (Alarm image FTP transmission) For example, enter “/ALARM” to designate the directory “ALARM” under the root directory of the FTP server.	ADIR
at_filename	Characters *) 1 – 32 characters	The file name used for the alarm image to be transmitted to an FTP server. (Alarm image FTP transmission)	APICNAME
post_framerate	0.1, 0.2, 0.33, 0.5, 1	Transmission interval 0.1 :0.1 fps 0.2 :0.2 fps 0.33 :0.33 fps 0.5 :0.5 fps 1 :1 fps	AINT
ftpост_num	1, 2, 3, 4, 5, 6, 7, 8, 9, 10, 20, 30, 50, 100, 200, 300, 1000, 2000, 3000, 5000	Number of images 0 :1 pic 2 :2 pics 3 :3 pics 4 :4 pics 5 :5 pics 6 :6 pics 7 :7 pics 8 :8 pics 9 :9 pics 10 :10 pics 20 :20 pics 30 :30 pics 50 :50 pics 100 :100 pics 200 :200 pics 300 :300 pics 1000 :1000 pics 2000 :2000 pics 3000 :3000 pics 5000 :5000 pics	ANUM
pre_framerate	0.1, 0.2, 0.33, 0.5, 1	Transmission interval before an alarm occurs	AINTPRE

Parameter name	Value	Comments	Parameter to get current setting (/cgi-bin/getdata)
ftppre_num	0, 1, 2, 3, 4, 5, 6, 7, 8, 9, 10, 20, 30, 40,50	Number of images	ANUMPRE
record_resolution	320, 640,800 1280,1920	Image capture size for alarm functions 320: JPEG(1) 640,800: JPEG(2) 1280,1920: JPEG(3)	ASIZE
ftp_retry	0,1	FTP transmission retry On: If transmission fails, transmissions are resent until they are successfully sent. Off: If transmission fails, the image that failed to be sent is discarded and the next image is sent.	AFTP_RETRY

[Command example]

Alarm image transmission setup (Alarm image FTP transmission: ON, Directory name: /ALARM, File name: Filename, Transmission interval: 1 fps, Number of images: 10 pics)

http://192.168.0.10/cgi-bin/jpeg_alarm?ftp_alarm=1&at_directory=/ALARM&at_filename=Filename&post_framerate=1&ftppost_num=10

11.5.3. Access permission to FTP server of the camera

[URL] /cgi-bin/set_server?ftpserver=<Value>

[Method] POST/GET

[Access level] 1

Parameter name	Value	Comments	Parameter to get current setting (/cgi-bin/getdata)
ftpserver	0, 1	0: Forbid 1: Allow	FTPS

[Command example]

Set to Allow

http://192.168.0.10/cgi-bin/set_server?ftpserver=1

Set to Forbid

http://192.168.0.10/cgi-bin/set_server?ftpserver=0

11.6. Camera discovery protocol (Easy IP Setup) setup

[URL] /cgi-bin/easyipset?time=<Value>

[Method] POST/GET

[Access level] 1

Parameter name	Value	Comments	Parameter to get current setting (/cgi-bin/getdata)
time	unlimited, 20	Time period that is enabled to change IP setting after turning on the power of the camera. Unlimited : Unlimited (Always acceptable) 20 : 20 minutes	EASYIPSETUP

[Command example]

Change setting to Unlimited

<http://192.168.0.10/cgi-bin/easyipset?time=unlimited>

11.7. SMTP setup

11.7.1. SMTP server setup

[URL] /cgi-bin/set_mail?[<Parameter name>=<Value>]

[Method] POST

[Access level] 1

Parameter name	Value	Comments	Parameter to get current setting (/cgi-bin/getdata)
smtpserver_addr	Characters	SMTP server address (IP address or host name) 1 – 128 characters	MLSRV
port_num	1 to 65535	SMTP port	SMTPPORT
popserver_addr	Characters	POP server address (IP address or host name) 1 – 128 characters	MLPOPSRV
server_auth	0, 1, 2	Authentication 0: None 1: POP before SMTP 2 :SMTP server authentication	MLAUTH
user_name	Characters	User name to access the server 0 – 32 characters	MLUSER
password	Characters	Password to access the server 0 – 32 characters	-
sender_mailaddr	Characters	Sender's mail address 3 – 128 characters	MLFRM
mail_ssl	0, 1	SSL 0: OFF 1: ON	MLSSL

[Command example]

e.g.) Mail server setting.

- SMTP server address: 10.77.239.77
- SMTP port: 22000
- POP server address: 10.77.239.82
- Authentication: POP before SMTP
- User name: user1
- Password: pass1
- Sender's mail address: test_user@i-pro.com

http://192.168.0.10/cgi-bin/set_mail?smtpserver_addr=10.77.239.77&port_num=22000&popserver_addr=10.77.239.82&server_auth=1&user_name=user1&password=pass1&sender_mailaddr=test_user@i-pro.com

11.7.2. E-mail setup

[URL] /cgi-bin/set_mail?[<Parameter name>=<Value>]

[Method] POST

[Access level] 1

Parameter name	Value	Comments	Parameter to get current setting (/cgi-bin/getdata)
mail	0, 1	Mail notification setting 0: OFF 1: ON	MLUSE
i_append	0, 1	Alarm image attachment 0: OFF 1: ON	MLPICT
resolution	jpeg, jpeg_2, jpeg_3	image capture size of images attached to an alarm E-mail jpeg: JPEG(1) jpeg_2: JPEG(2) jpeg_3: JPEG(3)	MLPICTSIZE
mail1_addr	Characters	Destination mail address 1	MLTOADD1
mail2_addr	Characters	Destination mail address 2	MLTOADD2
mail3_addr	Characters	Destination mail address 3	MLTOADD3
mail4_addr	Characters	Destination mail address 4	MLTOADD4
mail1_onoff	0, 1	To perform notification to “destination mail address 1” when an alarm is detected. 0: OFF 1: ON	MLALM1
mail2_onoff	0, 1	To perform notification to “destination mail address 2” when an alarm is detected.	MLALM2
mail3_onoff	0, 1	To perform notification to “destination mail address 3” when an alarm is detected.	MLALM3
mail4_onoff	0, 1	To perform notification to “destination mail address 4” when an alarm is detected.	MLALM4
mail1_self_onoff	0, 1	To perform the notification about SD card information to “destination IP address 1”.	MLNOTICE1
mail2_self_onoff	0, 1	To perform the notification about SD card information to “destination IP address 2”.	MLNOTICE2
mail3_self_onoff	0, 1	To perform the notification about SD card information to “destination IP address 3”.	MLNOTICE3
mail4_self_onoff	0, 1	To perform the notification about SD card information to “destination IP address 4”.	MLNOTICE4
mail_subject	Characters	Mail subject 0 – 50 characters	MLSUBJECT
mail_content	Characters	Mail body 0 – 200 characters	MLBODY
mail1_event_trm1	0, 1	Notify by e-mail when an alarm occurs in Terminal 1 to “destination mail address 1”. 0: OFF 1: ON	-
mail2_event_trm1	0, 1	Notify by e-mail when an alarm occurs in Terminal 1 to “destination mail address 2”.	-
mail3_event_trm1	0, 1	Notify by e-mail when an alarm occurs in Terminal 1 to “destination mail address 3”.	-
mail4_event_trm1	0, 1	Notify by e-mail when an alarm occurs in Terminal 1 to “destination mail address 4”.	-
mail1_event_trm2	0, 1	Notify by e-mail when an alarm occurs in Terminal 2 to “destination mail address 1”.	-
mail2_event_trm2	0, 1	Notify by e-mail when an alarm occurs in Terminal 2 to “destination mail address 2”.	-

Parameter name	Value	Comments	Parameter to get current setting (/cgi-bin/getdata)
mail3_event_trm2	0, 1	Notify by e-mail when an alarm occurs in Terminal 2 to "destination mail address 3".	-
mail4_event_trm2	0, 1	Notify by e-mail when an alarm occurs in Terminal 2 to "destination mail address 4".	-
mail1_event_trm3	0, 1	Notify by e-mail when an alarm occurs in Terminal 3 to "destination mail address 1".	-
mail2_event_trm3	0, 1	Notify by e-mail when an alarm occurs in Terminal 3 to "destination mail address 2".	-
mail3_event_trm3	0, 1	Notify by e-mail when an alarm occurs in Terminal 3 to "destination mail address 3".	-
mail4_event_trm3	0, 1	Notify by e-mail when an alarm occurs in Terminal 3 to "destination mail address 4".	-
mail1_event_vmd	0, 1	Notify by e-mail when motion is detected to "destination mail address 1".	-
mail2_event_vmd	0, 1	Notify by e-mail when motion is detected to "destination mail address 2".	-
mail3_event_vmd	0, 1	Notify by e-mail when motion is detected to "destination mail address 3".	-
mail4_event_vmd	0, 1	Notify by e-mail when motion is detected to "destination mail address 4".	-
mail1_event_com	0, 1	Notify by e-mail when a command alarm is detected to "destination mail address 1".	-
mail2_event_com	0, 1	Notify by e-mail when a command alarm is detected to "destination mail address 2".	-
mail3_event_com	0, 1	Notify by e-mail when a command alarm is detected to "destination mail address 3".	-
mail4_event_com	0, 1	Notify by e-mail when a command alarm is detected to "destination mail address 4".	-
mail1_event_audio detect	0, 1	Notify by e-mail when audio detection has occurred to "destination mail address 1".	-
mail2_event_audio detect	0, 1	Notify by e-mail when audio detection has occurred to "destination mail address 2".	-
mail3_event_audio detect	0, 1	Notify by e-mail when audio detection has occurred to "destination mail address 3".	-
mail4_event_audio detect	0, 1	Notify by e-mail when audio detection has occurred to "destination mail address 4".	-
mail1_event_attrack	0, 1	Notify by e-mail when an auto track alarm occurs to "destination mail address 1".	-
mail2_event_attrack	0, 1	Notify by e-mail when an auto track alarm occurs to "destination mail address 2".	-
mail3_event_attrack	0, 1	Notify by e-mail when an auto track alarm occurs to "destination mail address 3".	-
mail4_event_attrack	0, 1	Notify by e-mail when an auto track alarm occurs to "destination mail address 4".	-
mail_subject_cam name	0, 1	The camera title will be displayed in the e-mail subject. 0: OFF 1: ON	-

Parameter name	Value	Comments	Parameter to get current setting (/cgi-bin/getdata)
mail_subject_alarm	0, 1	Adds the cause of alarm to the E-mail subject. 0: OFF 1: ON	-
mail_content_alarm	0, 1	The cause of alarm %p% is added in the e-mail body. %p% is replaced by the cause of alarm and sent. 0: OFF 1: ON For VMD alarm: "VMD" For terminal alarm: Terminal name set in "Terminal 1", "Terminal 2", and "Terminal 3" of "Terminal name". (Example: If the name of Terminal 1 is "Terminal1", it is "Terminal1") For command alarm: "CMD" For audio detection alarm: "Audio detection" For Auto track alarm: "Auto track"	-
mail_content_time	0, 1	The time of occurrence %t% will be added to the e-mail body. %t% will be replaced by the time of occurrence of the alarm (HH:MM:SS) and sent. 0: OFF 1: ON	-
name_terminal1	Characters	The name of Terminal 1 used in the cause of alarm in the e-mail body 0 – 10 characters	-
name_terminal2	Characters	The name of Terminal 2 used in the cause of alarm in the e-mail body 0 – 10 characters	-
name_terminal3	Characters	The name of Terminal 3 used in the cause of alarm in the e-mail body 0 – 10 characters	-

11.8. NTP setup

[URL] /cgi-bin/time? [<Parameter name>=<Value>]

[Method] POST

[Access level] 1

Parameter name	Value	Comments	Parameter to get current setting (/cgi-bin/getdata)
time_adjust	0, 1	Time adjustment method 0: Manual setup 1: Synchronization with NTP server	TIMEADJUST
ntp_addr_dhcp	0,1	NTP server address setting When "Synchronization with NTP server" is selected for "Time adjustment", select the method of how to obtain the NTP server address from the following. 0:Manual The NTP server address will be entered manually on "NTP server address". 1:Auto Obtains the NTP server address from the DHCP server.	NTPSVR
ntp_addr	1-128 characters	NTP server address	NTPADD
ntp_port	1 to 65535	NTP port number 1 to 65535 *Except 20, 21, 23, 25, 42, 53, 67, 68, 69, 80, 110, 161, 162, 443, 554, 995, 10669, 10670, 59000 to 61000	NTPPORT
ntp_interval	1 to 24	Synchronization interval to NTP server 1 to 24(hours)	NTPINTERVAL

[Command examples]

Change the time adjustment method to NTP.

http://192.168.0.10/cgi-bin/time?time_adjust=1

Change the NTP server address to "192.168.0.20".

http://192.168.0.10/cgi-bin/time?ntp_addr=192.168.0.20

Change the time adjustment method and NTP server address and time zone, time adjustment method:
NTP, NTP server address: ntp.camera.com.

http://192.168.0.10/cgi-bin/time?time_adjust=1&ntp_addr=ntp.camera.com

11.9. SNMP setup

[Important]

- When these commands are sent from the Web browser like Internet Explorer, the network camera will return the error (400 Bad request) and it will not work correctly. This is due to our specification of enhancement of the security. These commands can be worked properly if they are sent from except the Web browser like Internet Explorer (i.e. from the original applications).

[URL] [/cgi-bin/set_snmp? \[<Parameter name>=<Value>\]](#)

[Method] POST

[Access level] 1

Parameter name	Value	Comments	Parameter to get current setting (/cgi-bin/getdata)
community	Characters	Community name (for SNMPv1/v2)	SNMPCOM
sysname	Characters	Camera title	SNMPTITLE
syslocation	Characters	Camera location	SNMPLOCATION
syscontact	Characters	Contact	SNMPCONTACT
snmp_ver	v1_v2, v3, v1_v2_v3	SNMP version v1_v2: SNMPv1/v2 v3: SNMPv3 v1_v2_v3: SNMPv1/v2/v3	-
user_name	Characters	User name (for SNMPv3)	-
auth_method	md5, sha-1	Authentication (for SNMPv3) md5: MD5 sha-1: SHA1	-
encryption	des, aes	Encryption method (for SNMPv3) des: DES aes: AES	-
password	Characters	Password (for SNMPv3)	-

[Command examples]

Change SNMP community name to "abcde"

http://192.168.0.10/cgi-bin/set_snmp?community=abcde

11.10. UPnP (automatic port forwarding)

[URL] [/cgi-bin/upnp? \[<Parameter name>=<Value>\]](#)

[Method] POST/GET

[Access level] 1

Parameter name	Value	Comments	Parameter to get current setting (/cgi-bin/getdata)
upnp_portmap	0, 1	Auto port forwarding 0: Off 1: On	PORTFORWARD
upnp_icon	0, 1	Camera short cut 0: Off 1: On	CAM_SC

[Command example]

Set Auto port forwarding: On, Camera short cut: On

http://192.168.0.10/cgi-bin/upnp?upnp_portmap=1&upnp_icon=1

12. Schedule setup

12.1. Schedule setup

[URL] /cgi-bin/set_schedulefunc?<Parameter name>=< Value>

[Method] Get/Post

[Access level] 1

Parameter name	Value	Comments	Parameter to get current setting (/cgi-bin/getdata)	
fnc1	0,1to 256 sd_recording sd_recording2 alm_enable alm_enable1 alm_enable2 alm_enable3 vmd_enable access_disable ftp_enable audio_alm_enable scene_file1 scene_file2 scene_file3 scene_file4 mail_enable restart ivmd1 ivmd2 scd_enable apend_apl1 apend_apl2	Schedule mode 1 0:Off 1 to256: Preset position number sd_recording: recording stream 1 sd_recording2: recording stream 2 alm_enable : Alarm permission alm_enable1: Terminal alarm 1 permission alm_enable2: Terminal alarm 2 permission alm_enable3: Terminal alarm 3 permission vmd_enable : VMD permission access_disable: Access permission ftp_enable:FTP periodic image transmission audio_alm_enable: Audio detection permission scene_file1: Scene file 1 scene_file2: Scene file 2 scene_file3: Scene file 3 scene_file4: Scene file 4 mail_enable: E-mail permission restart: Position refresh ivmd1: i-VMD detection program 1 ivmd2: i-VMD detection program 2 #When you use ivmd1 or ivmd2, set it with "installid1=258". scd_enable: SCD permission apend_apl1: Extension software1(Bestshotapp) apend_apl2: Extension software2(Bestshotapp) #When you use Extension software1 (Bestshotapp) or Extension software2 (Bestshotapp), set it with "installid1=259".	SCHEFUNC1	
mon1	0, 1	Time range	Mon. 0: Off, 1:On	MON1
tue1	0, 1		Tue. 0: Off, 1:On	TUE1
wed1	0, 1		Wed. 0: Off, 1:On	WED1
thu1	0, 1		Thu. 0: Off, 1:On	THU1
fri1	0, 1		Fri. 0: Off, 1:On	FRI1
sat1	0, 1		Sat. 0: Off, 1:On	SAT1
sun1	0, 1		Sun. 0: Off, 1:On	SUN1
time_mode1	1, 2		24H specified or not 2:24h mode 1:Time schedule	24HOUR1
start_hour1	0 to 23	Start time (Hour)	STARTHOUR1	
start_min1	0 to 59	Start time (Minute)	STARTMIN1	

Parameter name	Value	Comments		Parameter to get current setting (/cgi-bin/getdata)
end_hour1	0 to 23		End time (Hour)	ENDHOUR1
end_min1	0 to 59		End time (Minute)	ENDMIN1
fnc2	0,1to 256 sd_recording sd_recording2 alm_enable alm_enable1 alm_enable2 alm_enable3 vmd_enable access_disable ftp_enable audio_alm_enable scene_file1 scene_file2 scene_file3 scene_file4 mail_enable restart ivmd1 ivmd2 scd_enable apend_apl1 apend_apl2	Schedule mode 2		SCHEFUNC2
mon2	0, 1	Time range	Mon. 0: Off, 1:On	MON2
tue2	0, 1		Tue. 0: Off, 1:On	TUE2
wed2	0, 1		Wed. 0: Off, 1:On	WED2
thu2	0, 1		Thu. 0: Off, 1:On	THU2
fri2	0, 1		Fri. 0: Off, 1:On	FRI2
sat2	0, 1		Sat. 0: Off, 1:On	SAT2
sun2	0, 1		Sun. 0: Off, 1:On	SUN2
time_mode2	1, 2		24H specified or not	24HOUR2
start_hour2	0 to 23		Start time (Hour)	STARTHOUR2
start_min2	0 to 59		Start time (Minute)	STARTMIN2
end_hour2	0 to 23		End time (Hour)	ENDHOUR2
end_min2	0 to 59		End time (Minute)	ENDMIN2

Parameter name	Value	Comments	Parameter to get current setting (/cgi-bin/getdata)
fnc3	0,1to 256 sd_recording sd_recording2 alm_enable alm_enable1 alm_enable2 alm_enable3 vmd_enable access_disable ftp_enable audio_alm_enable scene_file1 scene_file2 scene_file3 scene_file4 mail_enable restart ivmd1 ivmd2 scd_enable apend_apl1 apend_apl2	Schedule mode 3	SCHEFUNC3
mon3	0, 1	Time range	Mon. 0: Off, 1:On
tue3	0, 1		Tue. 0: Off, 1:On
wed3	0, 1		Wed. 0: Off, 1:On
thu3	0, 1		Thu. 0: Off, 1:On
fri3	0, 1		Fri. 0: Off, 1:On
sat3	0, 1		Sat. 0: Off, 1:On
sun3	0, 1		Sun. 0: Off, 1:On
time_mode3	1, 2		24H specified or not
start_hour3	0 to 23		Start time (Hour)
start_min3	0 to 59		Start time (Minute)
end_hour3	0 to 23		End time (Hour)
end_min3	0 to 59		End time (Minute)
			TUE3
			WED3
			THU3
			FRI3
			SAT3
			SUN3
			24HOUR3
			STARTHOUR3
			STARTMIN3
			ENDHOUR3
			ENDMIN3

Parameter name	Value	Comments	Parameter to get current setting (/cgi-bin/getdata)
fnc4	0,1to 256 sd_recording sd_recording2 alm_enable alm_enable1 alm_enable2 alm_enable3 vmd_enable access_disable ftp_enable audio_alm_enable scene_file1 scene_file2 scene_file3 scene_file4 mail_enable restart ivmd1 ivmd2 scd_enable apend_apl1 apend_apl2	Schedule mode 4	SCHEFUNC4
mon4	0, 1	Time range	Mon. 0: Off, 1:On
tue4	0, 1		Tue. 0: Off, 1:On
wed4	0, 1		Wed. 0: Off, 1:On
thu4	0, 1		Thu. 0: Off, 1:On
fri4	0, 1		Fri. 0: Off, 1:On
sat4	0, 1		Sat. 0: Off, 1:On
sun4	0, 1		Sun. 0: Off, 1:On
time_mode4	1, 2		24H specified or not
start_hour4	0 to 23		Start time (Hour)
start_min4	0 to 59		Start time (Minute)
end_hour4	0 to 23		End time (Hour)
end_min4	0 to 59		End time (Minute)
			TUE4
			WED4
			THU4
			FRI4
			SAT4
			SUN4
			24HOUR4
			STARTHOUR4
			STARTMIN4
			ENDHOUR4
			ENDMIN4

Parameter name	Value	Comments	Parameter to get current setting (/cgi-bin/getdata)
fnc5	0,1 to 256 sd_recording sd_recording2 alm_enable alm_enable1 alm_enable2 alm_enable3 vmd_enable access_disable ftp_enable audio_alm_enable scene_file1 scene_file2 scene_file3 scene_file4 mail_enable restart ivmd1 ivmd2 scd_enable apend_apl1 apend_apl2 reset	Schedule mode 5 reset: Reboot (*fnc5 only)	SCHEFUNC5
mon5	0, 1	Time range	Mon. 0: Off, 1:On
tue5	0, 1		Tue. 0: Off, 1:On
wed5	0, 1		Wed. 0: Off, 1:On
thu5	0, 1		Thu. 0: Off, 1:On
fri5	0, 1		Fri. 0: Off, 1:On
sat5	0, 1		Sat. 0: Off, 1:On
sun5	0, 1		Sun. 0: Off, 1:On
time_mode5	1, 2		24H specified or not
start_hour5	0 to 23		Start time (Hour)
start_min5	0 to 59		Start time (Minute)
end_hour5	0 to 23		End time (Hour)
end_min5	0 to 59		End time (Minute)

[Command example]

Set schedule recording Sun. and Sat., 24h mode.

http://192.168.0.10/cgi-bin/set_schedulefunc?fnc1=sd_recording&sat1=1&sun1=1&time_mode1=2

*Before using this function, it is necessary to select 'Schedule' for 'Save trigger' in SD memory cark functions setting.

Set schedule to i-VMD detection program 1 at Sun. and Sat., 24h mode.

http://192.168.0.10/cgi-bin/set_schedulefunc?fnc1=ivmd1&sat1=1&sun1=1&time_mode1=2

*This CGI is worked only when the VMD function type (chapter 7.3.1) is selected for "i-VMD".

12.2. Schedule setup for extension software

12.2.1. Set a schedule of AI-VMD (1)

[URL] /cgi-bin/set_ext1_schedule?<Parameter name>=<Value>

[Method] Get/Post

[Access level] 1

Parameter name	Value	Comments		Parameter to get current setting (/cgi-bin/getdata)
mon	off/ t1/ t2	schedule	Operating day of week Off: Off t1: Time table 1 t2: Time table 2	EXT1_MON
tue	off/ t1/ t2		Operating day of week Off: Off t1: Time table 1 t2: Time table 2	EXT1_TUE
wed	off/ t1/ t2		Operating day of week Off: Off t1: Time table 1 t2: Time table 2	EXT1_WED
thu	off/ t1/ t2		Operating day of week Off: Off t1: Time table 1 t2: Time table 2	EXT1_THU
fri	off/ t1/ t2		Operating day of week Off: Off t1: Time table 1 t2: Time table 2	EXT1_FRI
sat	off/ t1/ t2		Operating day of week Off: Off t1: Time table 1 t2: Time table 2	EXT1_SAT
sun	off/ t1/ t2		Operating day of week Off: Off t1: Time table 1 t2: Time table 2	EXT1_SUN
start_hour1_t1	0 to 23		start time 1: hour (Time table 1)	EXT1_TIME1_SCHE1_START_H
start_min1_t1	0 to 59		start time 1: minute (Time table 1)	EXT1_TIME1_SCHE1_START_M
end_hour1_t1	0 to 23		end time 1: hour (Time table 1)	EXT1_TIME1_SCHE1_END_H
end_min1_t1	0 to 59		end time 1: minute (Time table 1)	EXT1_TIME1_SCHE1_END_M
ext_mode1_t1	0/ 1/ 2		Operation content 0: Off 1: Detection program 1 2: Detection program 2	EXT1_TIME1_SCHE1_MODE
start_hour2_t1	0 to 23		start time 2: hour (Time table 1)	EXT1_TIME1_SCHE2_START_H
start_min2_t1	0 to 59		start time 2: minute (Time table 1)	EXT1_TIME1_SCHE2_START_M
end_hour2_t1	0 to 23		end time 2: hour (Time table 1)	EXT1_TIME1_SCHE2_END_H
end_min2_t1	0 to 59		end time 2: minute (Time table 1)	EXT1_TIME1_SCHE2_END_M

Parameter name	Value	Comments	Parameter to get current setting (/cgi-bin/getdata)
ext_mode2_t1	0/ 1/ 2	Operation content 0: Off 1: Detection program 1 2: Detection program 2	EXT1_TIME1_SCHE2_MODE
start_hour3_t1	0 to 23	start time 3: hour (Time table 1)	EXT1_TIME1_SCHE3_START_H
start_min3_t1	0 to 59	start time 3: minute (Time table 1)	EXT1_TIME1_SCHE3_START_M
end_hour3_t1	0 to 23	end time 3: hour (Time table 1)	EXT1_TIME1_SCHE3_END_H
end_min3_t1	0 to 59	end time 3: minute (Time table 1)	EXT1_TIME1_SCHE3_END_M
ext_mode3_t1	0/ 1/ 2	Operation content 0: Off 1: Detection program 1 2: Detection program 2	EXT1_TIME1_SCHE3_MODE
start_hour4_t1	0 to 23	start time 4: hour (Time table 1)	EXT1_TIME1_SCHE4_START_H
start_min4_t1	0 to 59	start time 4: minute (Time table 1)	EXT1_TIME1_SCHE4_START_M
end_hour4_t1	0 to 23	end time 4: hour (Time table 1)	EXT1_TIME1_SCHE4_END_H
end_min4_t1	0 to 59	end time 4: minute (Time table 1)	EXT1_TIME1_SCHE4_END_M
ext_mode4_t1	0/ 1/ 2	Operation content 0: Off 1: Detection program 1 2: Detection program 2	EXT1_TIME1_SCHE4_MODE
start_hour5_t1	0 to 23	start time 5: hour (Time table 1)	EXT1_TIME1_SCHE5_START_H
start_min5_t1	0 to 59	start time 5: minute (Time table 1)	EXT1_TIME1_SCHE5_START_M
end_hour5_t1	0 to 23	end time 5: hour (Time table 1)	EXT1_TIME1_SCHE5_END_H
end_min5_t1	0 to 59	end time 5: minute (Time table 1)	EXT1_TIME1_SCHE5_END_M
ext_mode5_t1	0/ 1/ 2	Operation content 0: Off 1: Detection program 1 2: Detection program 2	EXT1_TIME1_SCHE5_MODE
start_hour6_t1	0 to 23	start time 6: hour (Time table 1)	EXT1_TIME1_SCHE6_START_H
start_min6_t1	0 to 59	start time 6: minute (Time table 1)	EXT1_TIME1_SCHE6_START_M
end_hour6_t1	0 to 23	end time 6: hour (Time table 1)	EXT1_TIME1_SCHE6_END_H
end_min6_t1	0 to 59	end time 6: minute (Time table 1)	EXT1_TIME1_SCHE6_END_M
ext_mode6_t1	0/ 1/ 2	Operation content 0: Off 1: Detection program 1 2: Detection program 2	EXT1_TIME1_SCHE6_MODE
start_hour1_t2	0 to 23	start time 1: hour (Time table 2)	EXT1_TIME2_SCHE1_START_H
start_min1_t2	0 to 59	start time 1: minute (Time table 2)	EXT1_TIME2_SCHE1_START_M
end_hour1_t2	0 to 23	end time 1: hour (Time table 2)	EXT1_TIME2_SCHE1_END_H

Parameter name	Value	Comments	Parameter to get current setting (/cgi-bin/getdata)
end_min1_t2	0 to 59	end time 1: minute (Time table 2)	EXT1_TIME2_SCHE1_END_M
ext_mode1_t2	0/ 1/ 2	Operation content 0: Off 1: Detection program 1 2: Detection program 2	EXT1_TIME2_SCHE1_MODE
start_hour2_t2	0 to 23	start time 2: hour (Time table 2)	EXT1_TIME2_SCHE2_START_H
start_min2_t2	0 to 59	start time 2: minute (Time table 2)	EXT1_TIME2_SCHE2_START_M
end_hour2_t2	0 to 23	end time 2: hour (Time table 2)	EXT1_TIME2_SCHE2_END_H
end_min2_t2	0 to 59	end time 2: minute (Time table 2)	EXT1_TIME2_SCHE2_END_M
ext_mode2_t2	0/1/ 2	Operation content 0: Off 1: Detection program 1 2: Detection program 2	EXT1_TIME2_SCHE2_MODE
start_hour3_t2	0 to 23	start time 3: hour (Time table 2)	EXT1_TIME2_SCHE3_START_H
start_min3_t2	0 to 59	start time 3: minute (Time table 2)	EXT1_TIME2_SCHE3_START_M
end_hour3_t2	0 to 23	end time 3: hour (Time table 2)	EXT1_TIME2_SCHE3_END_H
end_min3_t2	0 to 59	end time 3: minute (Time table 2)	EXT1_TIME2_SCHE3_END_M
ext_mode3_t2	0/ 1/ 2	Operation content 0: Off 1: Detection program 1 2: Detection program 2	EXT1_TIME2_SCHE3_MODE
start_hour4_t2	0 to 23	start time 4: hour (Time table 2)	EXT1_TIME2_SCHE4_START_H
start_min4_t2	0 to 59	start time 4: minute (Time table 2)	EXT1_TIME2_SCHE4_START_M
end_hour4_t2	0 to 23	end time 4: hour (Time table 2)	EXT1_TIME2_SCHE4_END_H
end_min4_t2	0 to 59	end time 4: minute (Time table 2)	EXT1_TIME2_SCHE4_END_M
ext_mode4_t2	0/ 1/ 2	Operation content 0: Off 1: Detection program 1 2: Detection program 2	EXT1_TIME2_SCHE4_MODE
start_hour5_t2	0 to 23	start time 5: hour (Time table 2)	EXT1_TIME2_SCHE5_START_H
start_min5_t2	0 to 59	start time 5: minute (Time table 2)	EXT1_TIME2_SCHE5_START_M
end_hour5_t2	0 to 23	end time 5: hour (Time table 2)	EXT1_TIME2_SCHE5_END_H
end_min5_t2	0 to 59	end time 5: minute (Time table 2)	EXT1_TIME2_SCHE5_END_M
ext_mode5_t2	0/ 1/ 2	Operation content 0: Off 1: Detection program 1 2: Detection program 2	EXT1_TIME2_SCHE5_MODE
start_hour6_t2	0 to 23	start time 6: hour (Time table 2)	EXT1_TIME2_SCHE6_START_H
start_min6_t2	0 to 59	start time 6: minute (Time table 2)	EXT1_TIME2_SCHE6_START_M

Parameter name	Value	Comments		Parameter to get current setting (/cgi-bin/getdata)
end_hour6_t2	0 to 23		end time 6: hour (Time table 2)	EXT1_TIME2_SCHE6_END_H
end_min6_t2	0 to 59		end time 6: minute (Time table 2)	EXT1_TIME2_SCHE6_END_M
ext_mode6_t2	0/ 1/ 2		Operation content 0: Off 1: Detection program 1 2: Detection program 2	EXT1_TIME2_SCHE6_MODE
installid	272	install ID	In case of AI-VMD, fixed value: 272	installid

[Command example]

Set a schedule to Sunday and Saturday on Time table 1.

http://192.168.0.10/cgi-bin/set_ext1_schedule?installid=272&sat=t1&sun=t1

Set "Operation content" to "Off" on Time table 1

http://192.168.0.10/cgi-bin/set_ext1_schedule?installid=272&ext_mode1_t1=0

Set "Operation content" to "Detection program 1" on Time table 1

http://192.168.0.10/cgi-bin/set_ext1_schedule?installid=272&ext_mode1_t1=1

12.2.2. Set a schedule of AI-VMD (2) and AI-VMD (3)

[Schedule of AI-VMD (2)]

[URL] /cgi-bin/set_ext2_schedule?<Parameter name>=<Value>

[Method] Get/Post

[Access level] 1

Parameter name	Value	Comments	Parameter to get current setting (/cgi-bin/getdata)
mon	off/ t1/ t2	schedule Operating day of week Off: Off t1: Time table 1 t2: Time table 2	EXT2_MON
tue	off/ t1/ t2	Operating day of week Off: Off t1: Time table 1 t2: Time table 2	EXT2_TUE
wed	off/ t1/ t2	Operating day of week Off: Off t1: Time table 1 t2: Time table 2	EXT2_WED
thu	off/ t1/ t2	Operating day of week Off: Off t1: Time table 1 t2: Time table 2	EXT2_THU
fri	off/ t1/ t2	Operating day of week Off: Off t1: Time table 1 t2: Time table 2	EXT2_FRI
sat	off/ t1/ t2	Operating day of week Off: Off t1: Time table 1 t2: Time table 2	EXT2_SAT
sun	off/ t1/ t2	Operating day of week Off: Off t1: Time table 1 t2: Time table 2	EXT2_SUN
start_hour1_t1	0 to 23	start time 1: hour (Time table 1)	EXT2_TIME1_SCHE1_START_H
start_min1_t1	0 to 59	start time 1: minute (Time table 1)	EXT2_TIME1_SCHE1_START_M
end_hour1_t1	0 to 23	end time 1: hour (Time table 1)	EXT2_TIME1_SCHE1_END_H
end_min1_t1	0 to 59	end time 1: minute (Time table 1)	EXT2_TIME1_SCHE1_END_M
ext_mode1_t1	0/ 1/ 2	Operation content 0: Off 1: Detection program 1 2: Detection program 2	EXT2_TIME1_SCHE1_MODE
start_hour2_t1	0 to 23	start time 2: hour (Time table 1)	EXT2_TIME1_SCHE2_START_H
start_min2_t1	0 to 59	start time 2: minute (Time table 1)	EXT2_TIME1_SCHE2_START_M
end_hour2_t1	0 to 23	end time 2: hour (Time table 1)	EXT2_TIME1_SCHE2_END_H
end_min2_t1	0 to 59	end time 2: minute (Time table 1)	EXT2_TIME1_SCHE2_END_M

Parameter name	Value	Comments	Parameter to get current setting (/cgi-bin/getdata)
ext_mode2_t1	0/ 1/ 2	Operation content 0: Off 1: Detection program 1 2: Detection program 2	EXT2_TIME1_SCHE2_MODE
start_hour3_t1	0 to 23	start time 3: hour (Time table 1)	EXT2_TIME1_SCHE3_START_H
start_min3_t1	0 to 59	start time 3: minute (Time table 1)	EXT2_TIME1_SCHE3_START_M
end_hour3_t1	0 to 23	end time 3: hour (Time table 1)	EXT2_TIME1_SCHE3_END_H
end_min3_t1	0 to 59	end time 3: minute (Time table 1)	EXT2_TIME1_SCHE3_END_M
ext_mode3_t1	0/ 1/ 2	Operation content 0: Off 1: Detection program 1 2: Detection program 2	EXT2_TIME1_SCHE3_MODE
start_hour4_t1	0 to 23	start time 4: hour (Time table 1)	EXT2_TIME1_SCHE4_START_H
start_min4_t1	0 to 59	start time 4: minute (Time table 1)	EXT2_TIME1_SCHE4_START_M
end_hour4_t1	0 to 23	end time 4: hour (Time table 1)	EXT2_TIME1_SCHE4_END_H
end_min4_t1	0 to 59	end time 4: minute (Time table 1)	EXT2_TIME1_SCHE4_END_M
ext_mode4_t1	0/ 1/ 2	Operation content 0: Off 1: Detection program 1 2: Detection program 2	EXT2_TIME1_SCHE4_MODE
start_hour5_t1	0 to 23	start time 5: hour (Time table 1)	EXT2_TIME1_SCHE5_START_H
start_min5_t1	0 to 59	start time 5: minute (Time table 1)	EXT2_TIME1_SCHE5_START_M
end_hour5_t1	0 to 23	end time 5: hour (Time table 1)	EXT2_TIME1_SCHE5_END_H
end_min5_t1	0 to 59	end time 5: minute (Time table 1)	EXT2_TIME1_SCHE5_END_M
ext_mode5_t1	0/ 1/ 2	Operation content 0: Off 1: Detection program 1 2: Detection program 2	EXT2_TIME1_SCHE5_MODE
start_hour6_t1	0 to 23	start time 6: hour (Time table 1)	EXT2_TIME1_SCHE6_START_H
start_min6_t1	0 to 59	start time 6: minute (Time table 1)	EXT2_TIME1_SCHE6_START_M
end_hour6_t1	0 to 23	end time 6: hour (Time table 1)	EXT2_TIME1_SCHE6_END_H
end_min6_t1	0 to 59	end time 6: minute (Time table 1)	EXT2_TIME1_SCHE6_END_M
ext_mode6_t1	0/ 1/ 2	Operation content 0: Off 1: Detection program 1 2: Detection program 2	EXT2_TIME1_SCHE6_MODE
start_hour1_t2	0 to 23	start time 1: hour (Time table 2)	EXT2_TIME2_SCHE1_START_H
start_min1_t2	0 to 59	start time 1: minute (Time table 2)	EXT2_TIME2_SCHE1_START_M
end_hour1_t2	0 to 23	end time 1: hour (Time table 2)	EXT2_TIME2_SCHE1_END_H

Parameter name	Value	Comments	Parameter to get current setting (/cgi-bin/getdata)
end_min1_t2	0 to 59	end time 1: minute (Time table 2)	EXT2_TIME2_SCHE1_END_M
ext_mode1_t2	0/ 1/ 2	Operation content 0: Off 1: Detection program 1 2: Detection program 2	EXT2_TIME2_SCHE1_MODE
start_hour2_t2	0 to 23	start time 2: hour (Time table 2)	EXT2_TIME2_SCHE2_START_H
start_min2_t2	0 to 59	start time 2: minute (Time table 2)	EXT2_TIME2_SCHE2_START_M
end_hour2_t2	0 to 23	end time 2: hour (Time table 2)	EXT2_TIME2_SCHE2_END_H
end_min2_t2	0 to 59	end time 2: minute (Time table 2)	EXT2_TIME2_SCHE2_END_M
ext_mode2_t2	0/ 1/ 2	Operation content 0: Off 1: Detection program 1 2: Detection program 2	EXT2_TIME2_SCHE2_MODE
start_hour3_t2	0 to 23	start time 3: hour (Time table 2)	EXT2_TIME2_SCHE3_START_H
start_min3_t2	0 to 59	start time 3: minute (Time table 2)	EXT2_TIME2_SCHE3_START_M
end_hour3_t2	0 to 23	end time 3: hour (Time table 2)	EXT2_TIME2_SCHE3_END_H
end_min3_t2	0 to 59	end time 3: minute (Time table 2)	EXT2_TIME2_SCHE3_END_M
ext_mode3_t2	0/ 1/ 2	Operation content 0: Off 1: Detection program 1 2: Detection program 2	EXT2_TIME2_SCHE3_MODE
start_hour4_t2	0 to 23	start time 4: hour (Time table 2)	EXT2_TIME2_SCHE4_START_H
start_min4_t2	0 to 59	start time 4: minute (Time table 2)	EXT2_TIME2_SCHE4_START_M
end_hour4_t2	0 to 23	end time 4: hour (Time table 2)	EXT2_TIME2_SCHE4_END_H
end_min4_t2	0 to 59	end time 4: minute (Time table 2)	EXT2_TIME2_SCHE4_END_M
ext_mode4_t2	0/ 1/ 2	Operation content 0: Off 1: Detection program 1 2: Detection program 2	EXT2_TIME2_SCHE4_MODE
start_hour5_t2	0 to 23	start time 5: hour (Time table 2)	EXT2_TIME2_SCHE5_START_H
start_min5_t2	0 to 59	start time 5: minute (Time table 2)	EXT2_TIME2_SCHE5_START_M
end_hour5_t2	0 to 23	end time 5: hour (Time table 2)	EXT2_TIME2_SCHE5_END_H
end_min5_t2	0 to 59	end time 5: minute (Time table 2)	EXT2_TIME2_SCHE5_END_M
ext_mode5_t2	0/ 1/ 2	Operation content 0: Off 1: Detection program 1 2: Detection program 2	EXT2_TIME2_SCHE5_MODE
start_hour6_t2	0 to 23	start time 6: hour (Time table 2)	EXT2_TIME2_SCHE6_START_H
start_min6_t2	0 to 59	start time 6: minute (Time table 2)	EXT2_TIME2_SCHE6_START_M

Parameter name	Value	Comments		Parameter to get current setting (/cgi-bin/getdata)
end_hour6_t2	0 to 23		end time 6: hour (Time table 2)	EXT2_TIME2_SCHE6_END_H
end_min6_t2	0 to 59		end time 6: minute (Time table 2)	EXT2_TIME2_SCHE6_END_M
ext_mode6_t2	0/ 1/ 2		Operation content 0: Off 1: Detection program 1 2: Detection program 2	EXT2_TIME2_SCHE6_MODE
installid	272	installed ID	In case of AI-VMD, fixed value: 272	installid

[Command example]

Set a schedule to Sunday and Saturday on Time table 1.

http://192.168.0.10/cgi-bin/set_ext2_schedule?installid=272&sat=t1&sun=t1

Set "Operation content" to "Off" on Time table 1

http://192.168.0.10/cgi-bin/set_ext2_schedule?installid=272&ext_mode1_t1=0

Set "Operation content" to "Detection program 1" on Time table 1

http://192.168.0.10/cgi-bin/set_ext2_schedule?installid=272&ext_mode1_t1=1

[Schedule of AI-VMD (3)]

[URL] /cgi-bin/set_ext3_schedule?<Parameter name>=<Value>

[Method] Get/Post

[Access level] 1

Parameter name	Value	Comments		Parameter to get current setting (/cgi-bin/getdata)
mon	off/ t1/ t2	schedule	Operating day of week Off: Off t1: Time table 1 t2: Time table 2	EXT3_MON
tue	off/ t1/ t2		Operating day of week Off: Off t1: Time table 1 t2: Time table 2	EXT3_TUE
wed	off/ t1/ t2		Operating day of week Off: Off t1: Time table 1 t2: Time table 2	EXT3_WED
thu	off/ t1/ t2		Operating day of week Off: Off t1: Time table 1 t2: Time table 2	EXT3_THU
fri	off/ t1/ t2		Operating day of week Off: Off t1: Time table 1 t2: Time table 2	EXT3_FRI
sat	off/ t1/ t2		Operating day of week Off: Off t1: Time table 1 t2: Time table 2	EXT3_SAT
sun	off/ t1/ t2		Operating day of week Off: Off t1: Time table 1 t2: Time table 2	EXT3_SUN

Parameter name	Value	Comments	Parameter to get current setting (/cgi-bin/getdata)
start_hour1_t1	0 to 23	start time 1: hour (Time table 1)	EXT3_TIME1_SCHE1_START_H
start_min1_t1	0 to 59	start time 1: minute (Time table 1)	EXT3_TIME1_SCHE1_START_M
end_hour1_t1	0 to 23	end time 1: hour (Time table 1)	EXT3_TIME1_SCHE1_END_H
end_min1_t1	0 to 59	end time 1: minute (Time table 1)	EXT3_TIME1_SCHE1_END_M
ext_mode1_t1	0/ 1/ 2	Operation content 0: Off 1: Detection program 1 2: Detection program 2	EXT3_TIME1_SCHE1_MODE
start_hour2_t1	0 to 23	start time 2: hour (Time table 1)	EXT3_TIME1_SCHE2_START_H
start_min2_t1	0 to 59	start time 2: minute (Time table 1)	EXT3_TIME1_SCHE2_START_M
end_hour2_t1	0 to 23	end time 2: hour (Time table 1)	EXT3_TIME1_SCHE2_END_H
end_min2_t1	0 to 59	end time 2: minute (Time table 1)	EXT3_TIME1_SCHE2_END_M
ext_mode2_t1	0/ 1/ 2	Operation content 0: Off 1: Detection program 1 2: Detection program 2	EXT3_TIME1_SCHE2_MODE
start_hour3_t1	0 to 23	start time 3: hour (Time table 1)	EXT3_TIME1_SCHE3_START_H
start_min3_t1	0 to 59	start time 3: minute (Time table 1)	EXT3_TIME1_SCHE3_START_M
end_hour3_t1	0 to 23	end time 3: hour (Time table 1)	EXT3_TIME1_SCHE3_END_H
end_min3_t1	0 to 59	end time 3: minute (Time table 1)	EXT3_TIME1_SCHE3_END_M
ext_mode3_t1	0/ 1/ 2	Operation content 0: Off 1: Detection program 1 2: Detection program 2	EXT3_TIME1_SCHE3_MODE
start_hour4_t1	0 to 23	start time 4: hour (Time table 1)	EXT3_TIME1_SCHE4_START_H
start_min4_t1	0 to 59	start time 4: minute (Time table 1)	EXT3_TIME1_SCHE4_START_M
end_hour4_t1	0 to 23	end time 4: hour (Time table 1)	EXT3_TIME1_SCHE4_END_H
end_min4_t1	0 to 59	end time 4: minute (Time table 1)	EXT3_TIME1_SCHE4_END_M
ext_mode4_t1	0/ 1/ 2	Operation content 0: Off 1: Detection program 1 2: Detection program 2	EXT3_TIME1_SCHE4_MODE
start_hour5_t1	0 to 23	start time 5: hour (Time table 1)	EXT3_TIME1_SCHE5_START_H
start_min5_t1	0 to 59	start time 5: minute (Time table 1)	EXT3_TIME1_SCHE5_START_M
end_hour5_t1	0 to 23	end time 5: hour (Time table 1)	EXT3_TIME1_SCHE5_END_H
end_min5_t1	0 to 59	end time 5: minute (Time table 1)	EXT3_TIME1_SCHE5_END_M

Parameter name	Value	Comments	Parameter to get current setting (/cgi-bin/getdata)
ext_mode5_t1	0/ 1/ 2	Operation content 0: Off 1: Detection program 1 2: Detection program 2	EXT3_TIME1_SCHE5_MODE
start_hour6_t1	0 to 23	start time 6: hour (Time table 1)	EXT3_TIME1_SCHE6_START_H
start_min6_t1	0 to 59	start time 6: minute (Time table 1)	EXT3_TIME1_SCHE6_START_M
end_hour6_t1	0 to 23	end time 6: hour (Time table 1)	EXT3_TIME1_SCHE6_END_H
end_min6_t1	0 to 59	end time 6: minute (Time table 1)	EXT3_TIME1_SCHE6_END_M
ext_mode6_t1	0/ 1/ 2	Operation content 0: Off 1: Detection program 1 2: Detection program 2	EXT3_TIME1_SCHE6_MODE
start_hour1_t2	0 to 23	start time 1: hour (Time table 2)	EXT3_TIME2_SCHE1_START_H
start_min1_t2	0 to 59	start time 1: minute (Time table 2)	EXT3_TIME2_SCHE1_START_M
end_hour1_t2	0 to 23	end time 1: hour (Time table 2)	EXT3_TIME2_SCHE1_END_H
end_min1_t2	0 to 59	end time 1: minute (Time table 2)	EXT3_TIME2_SCHE1_END_M
ext_mode1_t2	0/ 1/ 2	Operation content 0: Off 1: Detection program 1 2: Detection program 2	EXT3_TIME2_SCHE1_MODE
start_hour2_t2	0 to 23	start time 2: hour (Time table 2)	EXT3_TIME2_SCHE2_START_H
start_min2_t2	0 to 59	start time 2: minute (Time table 2)	EXT3_TIME2_SCHE2_START_M
end_hour2_t2	0 to 23	end time 2: hour (Time table 2)	EXT3_TIME2_SCHE2_END_H
end_min2_t2	0 to 59	end time 2: minute (Time table 2)	EXT3_TIME2_SCHE2_END_M
ext_mode2_t2	0/ 1/ 2	Operation content 0: Off 1: Detection program 1 2: Detection program 2	EXT3_TIME2_SCHE2_MODE
start_hour3_t2	0 to 23	start time 3: hour (Time table 2)	EXT3_TIME2_SCHE3_START_H
start_min3_t2	0 to 59	start time 3: minute (Time table 2)	EXT3_TIME2_SCHE3_START_M
end_hour3_t2	0 to 23	end time 3: hour (Time table 2)	EXT3_TIME2_SCHE3_END_H
end_min3_t2	0 to 59	end time 3: minute (Time table 2)	EXT3_TIME2_SCHE3_END_M
ext_mode3_t2	0/ 1/ 2	Operation content 0: Off 1: Detection program 1 2: Detection program 2	EXT3_TIME2_SCHE3_MODE
start_hour4_t2	0 to 23	start time 4: hour (Time table 2)	EXT3_TIME2_SCHE4_START_H
start_min4_t2	0 to 59	start time 4: minute (Time table 2)	EXT3_TIME2_SCHE4_START_M
end_hour4_t2	0 to 23	end time 4: hour (Time table 2)	EXT3_TIME2_SCHE4_END_H

Parameter name	Value		Comments	Parameter to get current setting (/cgi-bin/getdata)
end_min4_t2	0 to 59		end time 4: minute (Time table 2)	EXT3_TIME2_SCHE4_END_M
ext_mode4_t2	0/ 1/ 2		Operation content 0: Off 1: Detection program 1 2: Detection program 2	EXT3_TIME2_SCHE4_MODE
start_hour5_t2	0 to 23		start time 5: hour (Time table 2)	EXT3_TIME2_SCHE5_START_H
start_min5_t2	0 to 59		start time 5: minute (Time table 2)	EXT3_TIME2_SCHE5_START_M
end_hour5_t2	0 to 23		end time 5: hour (Time table 2)	EXT3_TIME2_SCHE5_END_H
end_min5_t2	0 to 59		end time 5: minute (Time table 2)	EXT3_TIME2_SCHE5_END_M
ext_mode5_t2	0/ 1/ 2		Operation content 0: Off 1: Detection program 1 2: Detection program 2	EXT3_TIME2_SCHE5_MODE
start_hour6_t2	0 to 23		start time 6: hour (Time table 2)	EXT3_TIME2_SCHE6_START_H
start_min6_t2	0 to 59		start time 6: minute (Time table 2)	EXT3_TIME2_SCHE6_START_M
end_hour6_t2	0 to 23		end time 6: hour (Time table 2)	EXT3_TIME2_SCHE6_END_H
end_min6_t2	0 to 59		end time 6: minute (Time table 2)	EXT3_TIME2_SCHE6_END_M
ext_mode6_t2	0/ 1/ 2		Operation content 0: Off 1: Detection program 1 2: Detection program 2	EXT3_TIME2_SCHE6_MODE
installid	272	installed ID	In case of AI-VMD, fixed value: 272	installid

[Command example]

Set a schedule to Sunday and Saturday on Time table 1.

http://192.168.0.10/cgi-bin/set_ext3_schedule?installid=272&sat=t1&sun=t1

Set "Operation content" to "Off" on Time table 1

http://192.168.0.10/cgi-bin/set_ext3_schedule?installid=272&ext_mode1_t1=0

Set "Operation content" to "Detection program 1" on Time table 1

http://192.168.0.10/cgi-bin/set_ext3_schedule?installid=272&ext_mode1_t1=1

13. Additional information & meta information

13.1. Capability information

CGI: /cgi-bin/get_capability

Related response:

`video_server.meta.type=<Value>`

Parameter name	Value	Comments
type	vmd, time, frame_time, face, audio_detect, attract, sdrec, audio, ivmd, vehicle_detect, people_count, mor, scenechg	Available meta data type vmd: VMD information time: Time information (Second) frame_time: Frame time information (millisecond) face: Face detection information audio_detect: Audio detection information attract: Auto track information sdrec: SD memory card recording information audio: Audio information ivmd: (WV-SAE200W) i-VMD information, (WV-XAE200W) AI-VMD information vehicle_detect: Vehicle incident detection information people_count: People count information mor: MOR information scenechg: Scene change information The value is divided by a comma. e.g.) vmd, time, frame_time, face

13.2. VMD information setup

[URL] /cgi-bin/set_vmdplay?vmdinfo=<Value>[&ch=<Value>]

[Method] GET/POST

[Access level] 1

Parameter name	Value	Comments	Parameter to get current setting (/cgi-bin/getdata)
vmdinfo	0, 1	additional VMD information 0: Off , 1: On Default: 0	VMDINFO
ch	1, 2, 3, 4	Channel 1: Channel 1, 2: Channel 2 3: Channel 3, 4: Channel 4 #This parameter is supported by Multi-sensor models.	VMDINFO_CH2 VMDINFO_CH3 VMDINFO_CH4

[Command example]

Add additional information

http://192.168.0.10/cgi-bin/set_vmdplay?vmdinfo=1

13.3. i-VMD information setup

[URL] /cgi-bin/set_ivmd_first?ivmd_info=<Value>

[Method] GET/POST

[Access level] 1

Parameter name	Value	Comments	Parameter to get current setting (/cgi-bin/getdata)
ivmd_info	0, 1, 2	i-VMD information addition 0: Off 1: On 2: On with frame display *1 Default: 2	IVMDINFO

*1: The function of a frame and locus display can be used in the camera browser.

[Command examples]

Set i-VMD information addition to "On" with i-VMD frame display.

http://192.168.0.10/cgi-bin/set_ivmd_first?ivmd_info=2

[Note] This CGI is worked only when the VMD function type (chapter 7.3.1) is selected for "i-VMD".

13.4. Auto track information setup

[URL] /cgi-bin/set_atrack?attrackinfo=<Value>

[Method] POST

[Access level] 1

Parameter name	Value	Comments	Parameter to get current setting (/cgi-bin/getdata)
attrackinfo	off on disp	Auto track data in video stream: off: Off on: On disp: On with frame display *1 Default: off	AT_INFO

*1: The function of a frame and locus display can be used in the camera browser.

13.5. People count information setup

[URL] /cgi-bin/set_ivmd_first?movcnt_info=<Value>

[Method] GET/POST

[Access level] 1

Parameter name	Value	Comments	Parameter to get current setting (/cgi-bin/getdata)
movcnt_info	0, 1, 2	i-VMD information addition 0: Off 1: On 2: On(Number of counts will be displayed on the browser) *1 Default: 2	IVMDPEOPLECOUNTINFO

*1: The function of a frame and locus display can be used in the camera browser.

13.6. Specification of each information

13.6.1. Time information (second)

Bit		0.	8.	16.	24.
Byte					
0	0	ID		Length	
	4	Clock			
	8	TimeZoneDirection	TimeZoneHour	TimeZoneMinute	SummerTime

Header Extensions

Parameter name	length(Bit)	Values and comments
ID	16	0x0011 (fixed)
Length	16	Total Data length (include ID and Length) (Unit of byte)
Clock	32	The career second from 1970
TimeZoneDirection	8	The direction of time zone 0x00 : positive value 0x01 : negative value
TimeZoneHour	8	Time zone (hour) 0x00: 0hours, 0x01: 1hours, 0x02: 2hours, 0x03: 3hours 0x04: 4hours, 0x05: 5hours, 0x06: 6hours, 0x07: 7hours 0x08: 8hours, 0x09: 9hours, 0x0a: 10hours, 0x0b: 11hours 0x0c: 12hours, 0x0d: 13hours, 0x0e: 14hours, 0x0f: 15hours 0x10: 16hours, 0x11: 17hours, 0x12: 18hours, 0x13: 19hours 0x14: 20hours, 0x15: 21hours, 0x16: 22hours, 0x17: 23hours
TimeZoneMinute	8	Time zone (minute) 0x00: 0minutes, 0x01: 1minutes, 0x02: 2minutes,, 0x39: 57minutes, 0x3a: 58minutes, 0x3b: :59minutes
SummerTime	8	0x00 :Not daylight saving time 0x01 :Daylight saving time (Summer time)

13.6.2. Frame time information (millisecond)

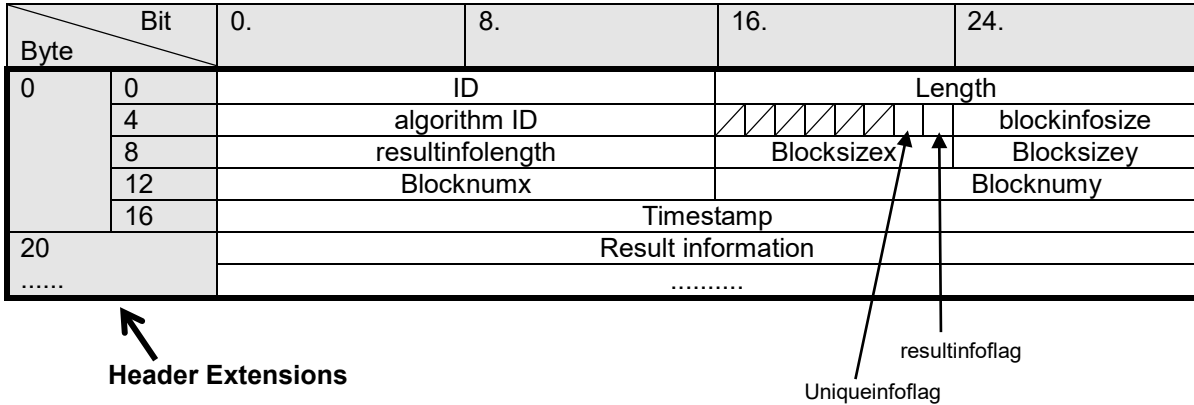
Bit		0.	8.	16.	24.
Byte					
0	0	ID		Length	
	4	FrameTime		Padding	

Header Extensions

Parameter name	length(Bit)	Values and comments
ID	16	0x0012 (fixed)
Length	16	Total Data length (include ID and Length) (Unit of byte)
FrameTime	16	Millisecond (Unit of 10 milliseconds) 0x0000: 0 millisecond, 0x0001: 10 milliseconds, 0x0062: 980 milliseconds, 0x0063: 990milliseconds
Padding	16	0x0000 (fixed)

13.6.3. VMD information

The format of the header extensions about VMD information was described as follows.

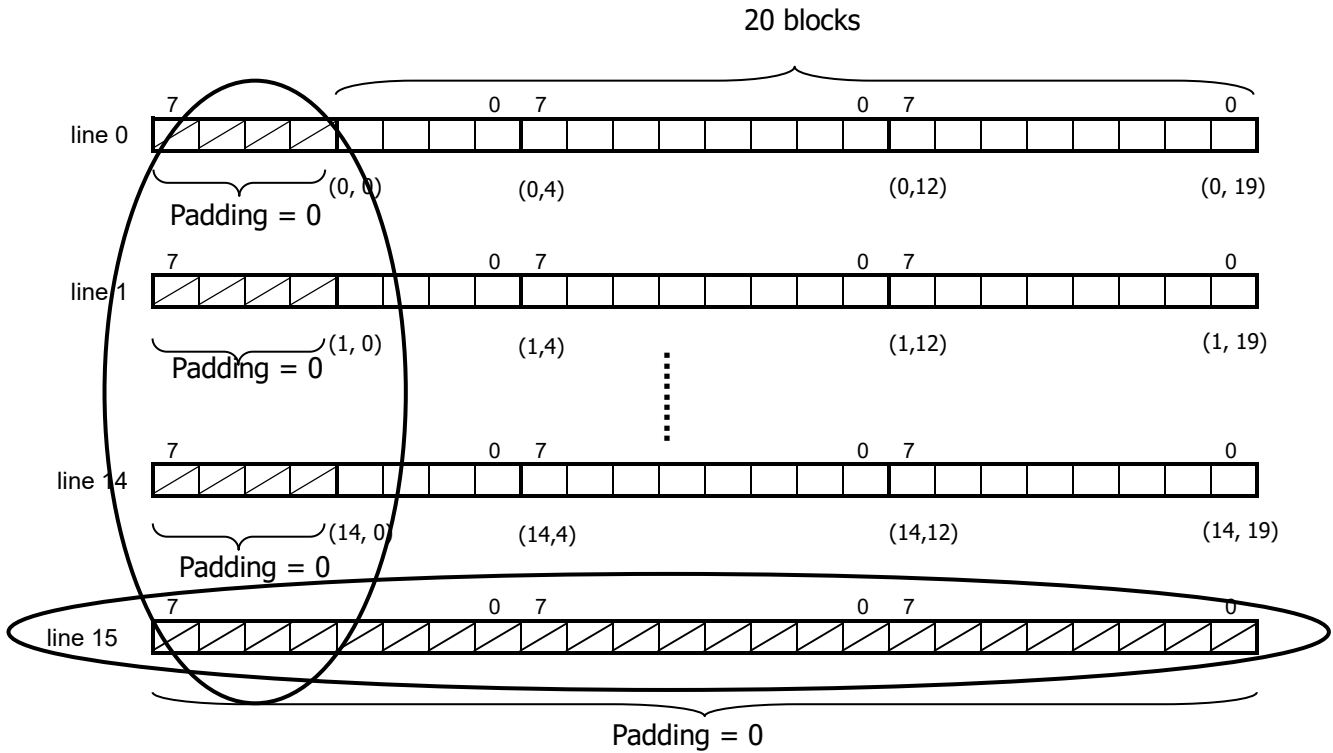


Values

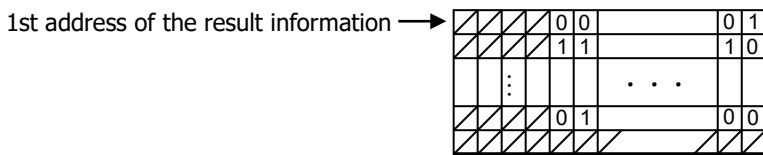
Parameter name	length(Bit)	Values and comments
ID	16	0x0010 (fixed)
Length	16	Total Data length (include ID and Length) (Unit of byte)
algorithmID(*)	16	Algorithm ID
uniqueinfoflag(*)	1	0 (fix)
blockinfosize(*)	8	1 (fix)
resultinfoflength(*)	16	Length of the Result information (Unit of byte)
Blocksizey(*)	8	Block Size (Horizontal)
Blocksizey(*)	8	Block Size (Vertical)
Blocknumx(*)	16	Number of blocks (Horizontal)
Blocknumy(*)	16	Number of blocks (Vertical)
Timestamp(*)	32	Capture time of image
Result information(*)	Variable	VMD information of every block. 0: the block without movement 1: the block with movement - In every line, the left side is filled by the padding '0'. - When the data length doesn't become every 4 byte, the tail of the data is filled by the padding '0'.

(*) It exists when Extension is true.

Result information format is following.
 e.g.). Number of blocks: 20 x 15.



Follow is the example of the block information format

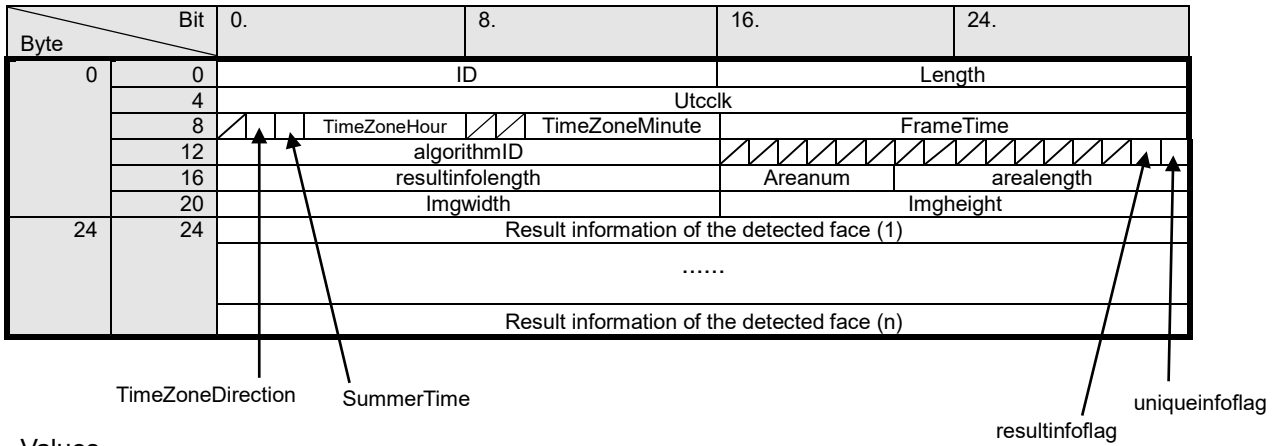


[Note]

The specification of the VMD information

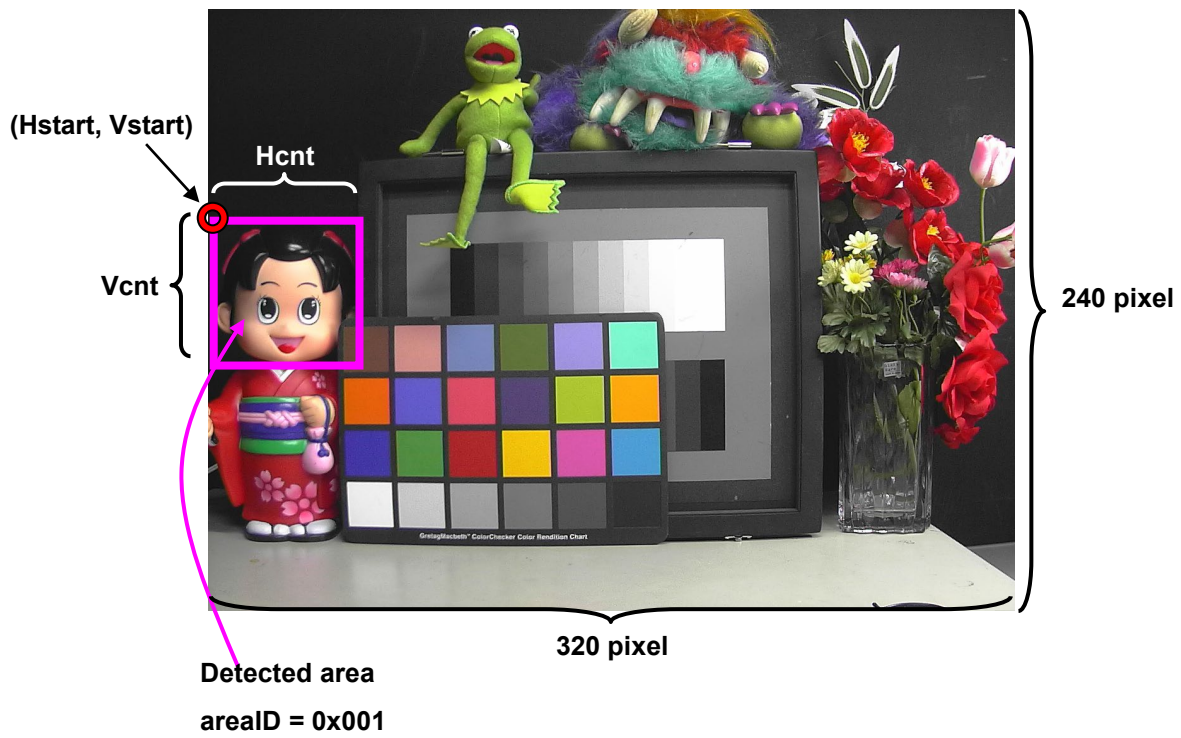
- VMD result information is refreshed every 200 milliseconds.
- Basically, VMD result information is attached in all frames.
- When every blocks are 0 (i.e. without motion), the camera doesn't send any result information.

13.6.4. Face detection information



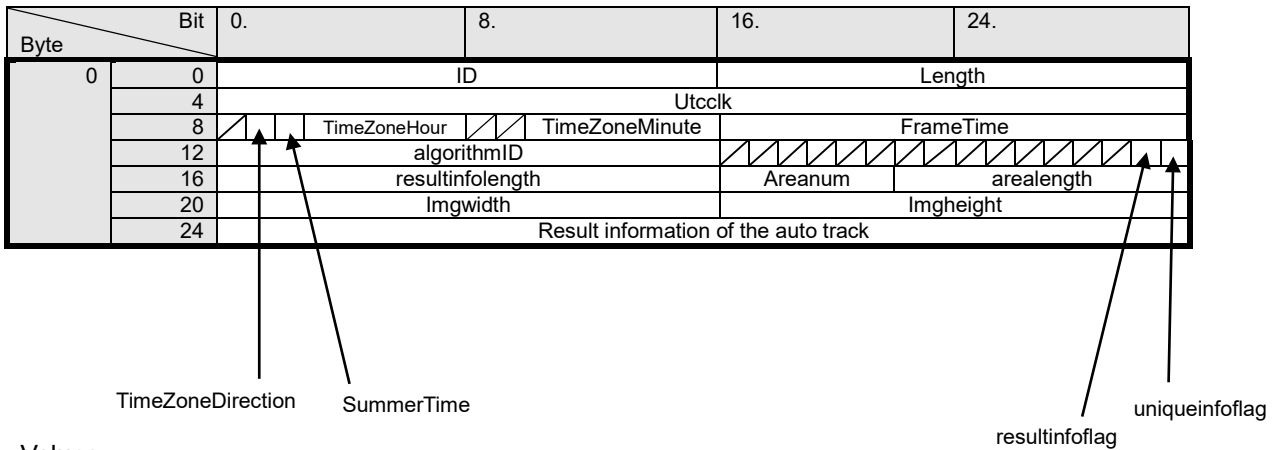
Values

Parameter name	length(Bit)	Values and comments
ID	16	0x000F (fixed)
Length	16	Total data length of the face detection information (Include 'ID(2byte)' and 'Length(2byte)') (Unit of byte)
Utcclock	32	The career second from 1970 (UTC clock) of the face detection information.
TimeZoneDirection	1	The direction of time zone 0 (b) : positive value 1 (b) : negative value
SummerTime	1	0x00 :Not daylight saving time 0x01 :Daylight saving time (Summer time)
TimeZoneHour	5	Time zone (hour) 0x00: 0hours, 0x01: 1hours, 0x02: 2hours, 0x03: 3hours 0x04: 4hours, 0x05: 5hours, 0x06: 6hours, 0x07: 7hours 0x08: 8hours, 0x09: 9hours, 0x0a: 10hours, 0x0b: 11hours 0x0c: 12hours, 0x0d: 13hours, 0x0e: 14hours, 0x0f: 15hours 0x10: 16hours, 0x11: 17hours, 0x12: 18hours, 0x13: 19hours 0x14: 20hours, 0x15: 21hours, 0x16: 22hours, 0x17: 23hours
TimeZoneMinute	6	Time zone (minute) 0x00: 0minutes, 0x01: 1minutes, 0x02: 2minutes, 0x39: 57minutes, 0x3a: 58minutes, 0x3b: :59minutes
FrameTime	16	Millisecond (Unit of 10 milliseconds) of the face detection information. 0x0000: 0 millisecond, 0x0001: 10 milliseconds, 0x0062: 980 milliseconds, 0x0063: 990milliseconds
resultinfoflag	1	Result information flag 0 (b): Not include the result information 1 (b): Include the unique information
uniqueinfoflag	1	0 (b) (fixed)
algorithmID	16	0x0000 (fixed)
resultinfoflag	16	Length of the Result information (Unit of byte)
Arealnum	6	The number of detected face Maximum: 0x08
arealength	10	The data length of a result information in each detected face. (Unit of byte) 16 byte (fixed)
Imgwidth	16	Width of the image for the face detection 0x0140 (fixed)
Imgheight	16	Height of the image for the face detection 0x00F0 (fixed)



Every time, the coordinates in the face detection information are in 320x240 resolution. This information is refreshed every 200 milliseconds.

13.6.5. Auto track information



Parameter name	length(Bit)	Values and comments
ID	16	0x0013 (fixed)
Length	16	Total data length of the auto track information (Include 'ID(2byte)' and 'Length(2byte)') (Unit of byte)
Utclk	32	The career second from 1970 (UTC clock) of the auto track information.
TimeZoneDirection	1	The direction of time zone 0 (b) : positive value 1 (b) : negative value
SummerTime	1	0x00 :Not daylight saving time 0x01 :Daylight saving time (Summer time)
TimeZoneHour	5	Time zone (hour) 0x00: 0hours, 0x01: 1hours, 0x02: 2hours, 0x03: 3hours 0x04: 4hours, 0x05: 5hours, 0x06: 6hours, 0x07: 7hours 0x08: 8hours, 0x09: 9hours, 0x0a: 10hours, 0x0b: 11hours 0x0c: 12hours, 0x0d: 13hours, 0x0e: 14hours, 0x0f: 15hours 0x10: 16hours, 0x11: 17hours, 0x12: 18hours, 0x13: 19hours 0x14: 20hours, 0x15: 21hours, 0x16: 22hours, 0x17: 23hours
TimeZoneMinute	6	Time zone (minute) 0x00: 0minutes, 0x01: 1minutes, 0x02: 2minutes, 0x39: 57minutes, 0x3a: 58minutes, 0x3b: :59minutes
FrameTime	16	Millisecond (Unit of 10 milliseconds) of the auto track information. 0x0000: 0 millisecond, 0x0001: 10 milliseconds, 0x0062: 980 milliseconds, 0x0063: 990milliseconds
resultinfoflag	1	Result information flag 0 (b): Not include the result information 1 (b): Include the unique information
uniqueinfoflag	1	0 (b) (fixed)
algorithmID	16	0x0000 (fixed)
resultinfo length	16	Length of the Result information (Unit of byte)
Areamum	6	The number of auto track (1:fixed)
arealength	10	The data length of a result information
Imgwidth	16	Width of the image for the auto track 0x0140 (fixed)
Imgheight	16	Height of the image for the auto track 0x00F0 (fixed)

Each result information of the auto track

Byte	Bit	0.	8.	16.	24.
0	0	arealD		dtctarea	state
	4	Hstart		Vstart	
	8	Hcnt		Vcnt	

Values

Parameter name	length(Bit)	Values and comments
arealD	16	0x0001 (fixed)
dtctarea	8	Detect area num 0x01(fixed)
state	2	Alarm state 01(b) : Not auto track alarm state 10(b) : Auto track alarm state
Hstart	16	X coordinate (Upper left) of the rectangle for the auto track object in 320x240 resolution.
Vstart	16	Y coordinate (Upper left) of the rectangle for the auto track object in 320x240 resolution.
Hcnt	16	Width of the rectangle for the auto track object (Horizontal) in 320x240 resolution
Vcnt	16	Height of the rectangle for the auto track object (Vertical) in 320x240 resolution

As is the case with face detect, the coordinates in the auto track information are in 320x240 resolution. This information is refreshed every 200 milliseconds.

13.6.6. Audio detection information

Byte \ Bit		Bit			
		0.	8.	16.	24.
0	0	ID		Length	
	4	audioLevel	audioAlarmth	Reserve	

Values

Parameter name	length(Bit)	Values and comments
ID	16	0x0019 (Fix)
Length	16	Total data length of the face detection information (Include 'ID(2byte)' and 'Length(2byte)') (Unit of byte)
audioLevel	8	Audio detection level (0 to 0x0A)
audioAlarmth	8	Threshold of the alarm detection (0 to 0x09)
Reserve	16	

13.6.7. SD memory card recording information

Byte \ Bit		Bit			
		0.	8.	16.	24.
0	0	ID		Length	
	4	SDRecStatus1	SDRecStatus2	Reserve	

Values

Parameter name	length(Bit)	Values and comments
ID	16	0x001e (Fix)
Length	16	Total data length of the SD rec information (Include 'ID(2byte)' and 'Length(2byte)') (Unit of byte)
SDRecStatus1	8	Status of "SD recording" regarding the recording stream 1 - Alarm rec: 0000 0010 - Manual rec: 0000 0100 - Schedule rec: 0000 1000 - NW lost rec: 0001 0000
SDRecStatus2	8	Status of "SD recording " regarding the recording stream 2
Reserve	16	

13.6.8. Audio information

Bit		0.	8.	16.	24.
Byte	0	ID		Length	
	4	audioOutUID		audioMode	audioOut Status Reserve

Values

Parameter name	length(Bit)	Values and comments
ID	16	0x001f (Fix)
Length	16	Total data length of the SD rec information (Include 'ID(2byte)' and 'Length(2byte)') (Unit of byte)
audioOutUID	8	UID number which is used for the "audio out"
audioMode	8	Setting value of the audio mode 0x00: Off 0x01: Mic input 0x02: Audio output 0x03: Interactive (Half duplex) 0x04: Interactive (Full duplex)
audioOutStatus	16	Status of the audio out 0x00: Audio out isn't streaming. 0x01: Audio out is streaming.
Reserve	8	

13.6.9. Long term information

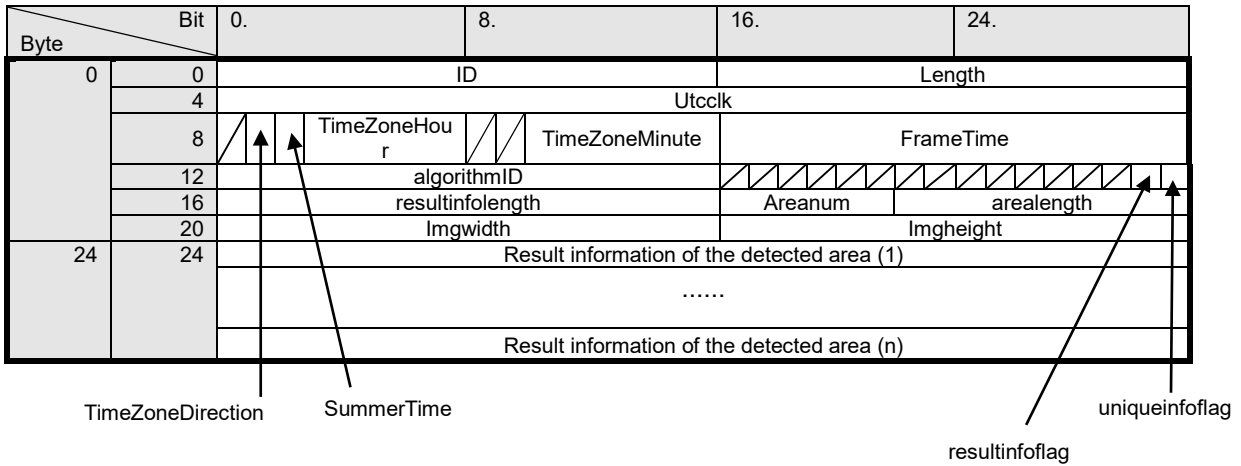
This information will be added to the H.265 stream when "On(Advanced)" is set for GOP control.

Bit		0.	8.	16.	24.
Byte	0	ID		Length	
	4	Longterm	FrameType	Reserve	

Values

Parameter name	length(Bit)	Values and comments
ID	16	0x002A (Fix)
Length	16	Total data length of this information (Include 'ID(2byte)' and 'Length(2byte)') (Unit of byte)
Longterm	8	Long term stream or not 0x00: Normal stream 0x01: Long-term stream *Always 0x01.
FrameType	8	Frame type 0x00: IDR, Not key(P) frame 0x01: IDR 0x02: Key (P) frame

13.6.10. i-VMD information



Parameter name	length(Bit)	Values and comments
ID	16	0x000E (fixed)
Length	16	Total data length of the i-VMD information (Include 'ID(2byte)' and 'Length(2byte)') (Unit of byte)
Utcclock	32	The career second from 1970 (UTC clock) of the i-VMD detection information.
TimeZoneDirection	1	The direction of time zone 0 (b) : positive value 1 (b) : negative value
SummerTime	1	0x00 :Not daylight saving time 0x01 :Daylight saving time (Summer time)
TimeZoneHour	5	Time zone (hour) 0x00: 0hours, 0x01: 1hours, 0x02: 2hours, 0x03: 3hours 0x04: 4hours, 0x05: 5hours, 0x06: 6hours, 0x07: 7hours 0x08: 8hours, 0x09: 9hours, 0x0a: 10hours, 0x0b: 11hours 0x0c: 12hours, 0x0d: 13hours, 0x0e: 14hours, 0x0f: 15hours 0x10: 16hours, 0x11: 17hours, 0x12: 18hours, 0x13: 19hours 0x14: 20hours, 0x15: 21hours, 0x16: 22hours, 0x17: 23hours
TimeZoneMinute	6	Time zone (minute) 0x00: 0minutes, 0x01: 1minutes, 0x02: 2minutes,, 0x39: 57minutes, 0x3a: 58minutes, 0x3b: :59minutes
FrameTime	16	Millisecond (Unit of 10 milliseconds) of the i-VMD detection information. 0x0000: 0 millisecond, 0x0001: 10 milliseconds, 0x0062: 980 milliseconds, 0x0063: 990milliseconds
algorithmID	16	0x0000 (fixed)
resultinfoflag	1	Result information flag 0 (b): Not include the result information 1 (b): Include the unique information
uniqueinfoflag	1	0 (b) (fixed)
resultinfo length	16	Length of the Result information (Unit of byte)
Areatum	6	The number of the i-VMD detection Maximum: 0x08
arealength	10	The data length of a result information in each i-VMD detection. (Unit of byte)
Imgwidth	16	Width of the image for the i-VMD detection
Imgheight	16	Height of the image for the i-VMD detection

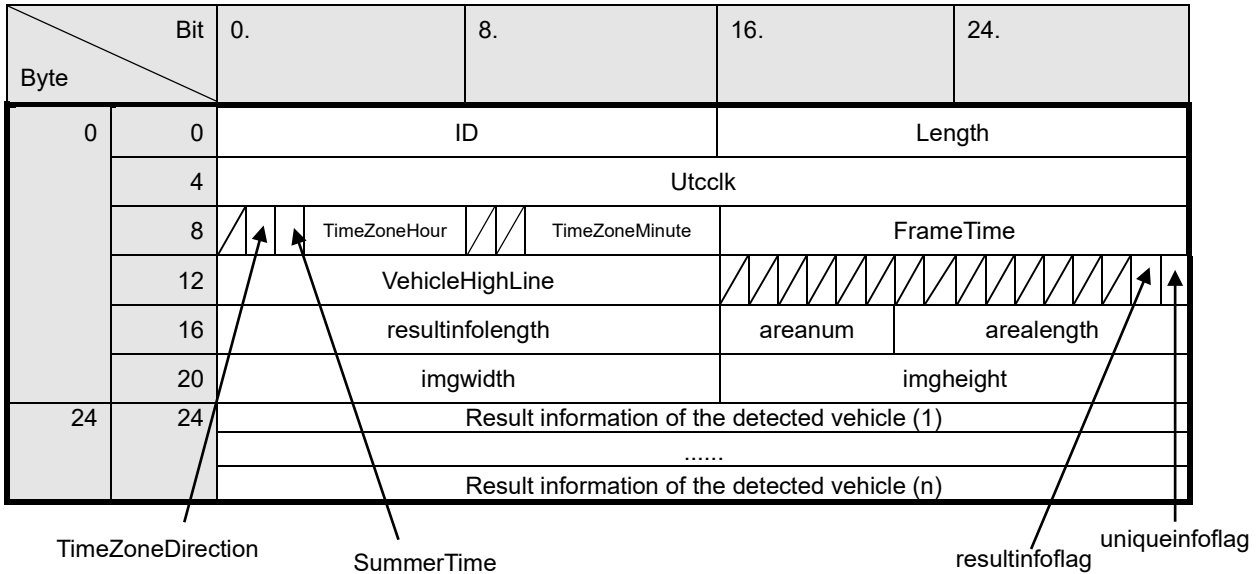
Each result information of the detected frame

Byte	Bit	0.	8.	16.	24.
0	0	arealD		dtctarea	state
	4	Hstart		Vstart	
	8	Hcnt		Vcnt	

Value	length(Bit)	Values and comments
arealD	16	ID of the detected frame 0 to 65535
dtctarea	8	0x01 : Detection area 1 0x02 : Detection area 2 0x04 : Detection area 3 0x08 : Detection area 4 0x10 : Detection area 5 0x20 : Detection area 6 0x40 : Detection area 7 0x80 : Detection area 8
state	8	Alarm status 0x11: Intruder detection 0x21: Loitering detection 0x31: Direction detection 0x42 or 0x02 (Old specifications): Object detection 0x51: Cross line detection 0xF0 or 0x00 (Old specifications): Not alarmed 0x01 (Old specifications): Intruder, Loitering, Direction of Crossline
Hstart	16	X coordinate (Upper left) of the rectangle for the i-VMD object in 320x240 resolution.
Vstart	16	Y coordinate (Upper left) of the rectangle for the i-VMD object in 320x240 resolution.
Hcnt	16	Width of the rectangle for the i-VMD object (Horizontal) in 320x240 resolution
Vcnt	16	Height of the rectangle for the i-VMD object (Vertical) in 320x240 resolution

i-VMD information is refreshed every [100 milliseconds](#).

13.6.11. Vehicle Incident Detection information



Parameter name	length(Bit)	Values and comments
ID	16	0x002c (ID of the Vehicle Incident Detection information) (fixed)
Length	16	Total data length of the Vehicle Incident Detection information (Include 'ID(2byte)' and 'Length(2byte)') (Unit of byte)
Utclk	32	The career second from 1970 (UTC clock)
TimeZoneDirection	1	The direction of time zone 0 (b) : positive value, 1 (b) : negative value
SummerTime	1	0x00 :Not daylight saving time 0x01 :Daylight saving time (Summer time)
TimeZoneHour	5	Time zone (hour) 0x00: 0hours, 0x01: 1hours, 0x02: 2hours,0x03: 3hours, 0x04: 4hours, 0x05: 5hours, 0x06: 6hours, 0x07: 7hours, 0x08: 8hours, 0x09: 9hours, 0x0a: 10hours, 0x0b: 11hours, 0x0c: 12hours,0x0d:13hours, 0x0e: 14hours, 0x0f: 15hours, 0x10: 16hours, 0x11: 17hours, 0x12: 18hours, 0x13: 19hours 0x14: 20hours, 0x15: 21hours, 0x16: 22hours,0x17: 23hours
TimeZoneMinute	6	Time zone (minute) 0x00: 0minutes, 0x01: 1minutes, 0x02: 2minutes,, 0x39: 57minutes, 0x3a: 58minutes, 0x3b: :59minutes
FrameTime	16	Millisecond (Unit of 10 milliseconds) of the i-VMD detection information. 0x0000: 0 millisecond, 0x0001: 10 milliseconds, 0x0062: 980 milliseconds, 0x0063: 990milliseconds
VehicleHighLine	16	Hight of the detected vehicle 0 - 479 (0, 0) - (639, 479)

resultinfoflag	1	Result information flag 0 (b): Not include the result information 1 (b): Include the unique information
uniqueinfoflag	1	0 (b) (fixed)
resultinfolelength	16	Length of the Result information (Unit of byte)
Areanum	6	The number of the detected area
arealelength	10	Length of a result information in each detected area. (Unit of byte)
Imgwidth	16	Width of the detected area.
Imgheight	16	Height of the detected area.

Each result information of the detected area

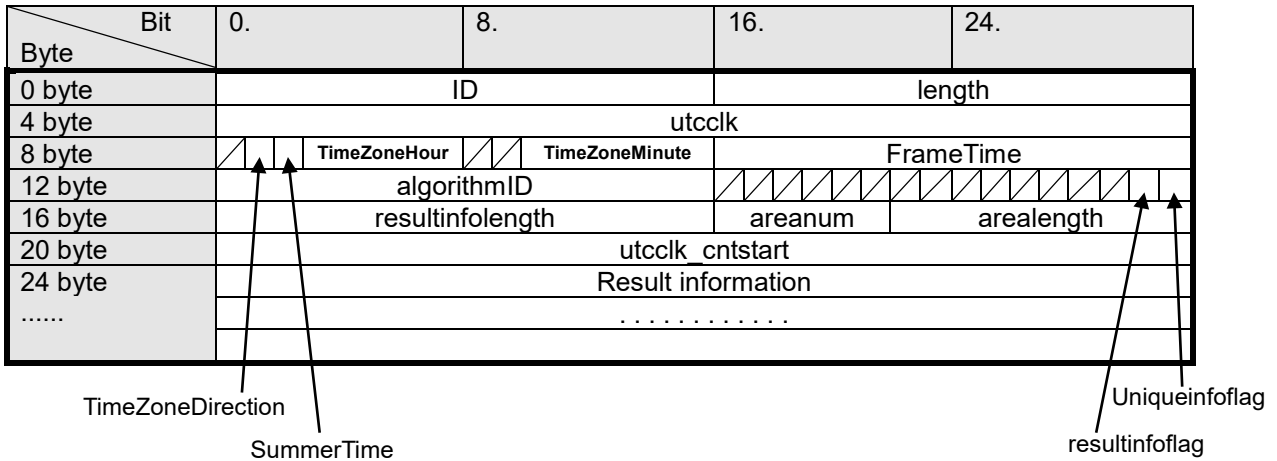
		Bit	0.	8.	16.	24.
Byte						
0	0	arealD			Hstart	
	4	Vstart			Hcnt	
	8	Vcnt			Almtype	VehicleArea

Parameter name	length(Bit)	Values and comments
arealD	16	ID of the detected frame
Hstart	16	X coordinate (Upper left) of the rectangle for the detected vehicle
Vstart	16	Y coordinate (Upper left) of the rectangle for the detected vehicle
Hcnt	16	Width of the rectangle for the detected vehicle
Vcnt	16	Height of the rectangle for the detected vehicle
Almtype	8	Alarm type 0x00(0000b) : Not alarmed 0x01(0001b) : Stopped vehicle 0x02(0010b) : Wrong-way vehicle 0x03 - 0xFF : Reserve
VehicleArea	8	Lane of the detection 0x00(0000b) : Reserve 0x01(0001b) : Lane 1 ,0x02(0010b) : Lane 2 0x03(0011b) : Lane 3, 0x04(0100b) : Lane 4

The vehicle incident information is refreshed every 100 milliseconds

The result information of the vehicle incident information is maximum 64.

13.6.12. People count information



Parameter name	length(Bit)	Values and comments
ID	16	0x0021 (Fixed)
length	16	Total Data length (include ID and Length) (Unit of byte)
utcclk	32	The career second from 1970 (UTC time)
TimeZoneDirection	1	The direction of time zone 0 (b) : positive value 1 (b) : negative value
SummerTime	1	0 (b) :Not daylight saving time 1 (b) :Daylight saving time (Summer time)
TimeZoneHour	5	Time zone (hour) 0x00: 0hours, 0x01: 1hours, 0x02: 2hours, 0x03: 3hours 0x04: 4hours, 0x05: 5hours, 0x06: 6hours, 0x07: 7hours 0x08: 8hours, 0x09: 9hours, 0x0a: 10hours, 0x0b: 11hours 0x0c: 12hours, 0x0d: 13hours, 0x0e: 14hours, 0x0f: 15hours 0x10: 16hours, 0x11: 17hours, 0x12: 18hours, 0x13: 19hours 0x14: 20hours, 0x15: 21hours, 0x16: 22hours, 0x17: 23hours
TimeZoneMinute	6	Time zone (minute) 0x00: 0minutes, 0x01: 1minutes, 0x02: 2minutes, 0x39: 57minutes, 0x3a: 58minutes, 0x3b: :59minutes
FrameTime	16	Millisecond (Unit of 10 milliseconds) 0x0000: 0 millisecond, 0x0001: 10 milliseconds, 0x0062: 980 milliseconds, 0x0063: 990milliseconds
algorithmID	16	Algorithm ID
resultinfoflag	1	Result information flag 0 (b): Not include the result information 1 (b): Include the unique information
uniqueinfoflag	1	0(b) (fixed)
resultinfoflag	16	Length of the Result information (Unit of byte)
areanum	6	Number of line.
arealength	10	Data amount by each line (Unit of byte)
utcclk_cntstart	32	Time that started to count the number of people from The career second from 1970(UTC time)
Result information	Variable	People count information

About the Result information:

Byte \ Bit	0.	8.	16.	24.
0 byte	areaID		state	
4 byte	fromAtoB		fromBtoA	

Parameter name	length(Bit)	Values and comments
areaID	16	line ID
state	2	Status 0 :The line is disabled 1 :The line is enabled (direction: A→B) 2 :The line is enabled (direction: A←B) 3 :The line is enabled (both direction: B←→A)
fromAtoB	16	The number of counting people (direction: A→B)
fromBtoA	16	The number of counting people (direction: A←B)

13.6.13. MOR information

Byte \ Bit	0.	8.	16.	24.
0 byte	ID		length	
4 byte	mode	reserved	reserved	

Parameter name	length(Bit)	Values and comments
ID	16	0x0022 (fixed)
length	16	Total Data length (include ID and Length) (Unit of byte)
mode	16	0x00 :MOR Off 0x01 :MOR On 0x02 :MOR On (Overlapping display)
reserved	8	Padding (0)
reserved	16	Padding (0)

Each result information of the detected frame

Byte	Bit	0.	8.	16.	24.	
0	0	arealD			dtctarea	
	4	almtype	dir	almobj		
	8	Hstart			Vstart	
	12	Hcnt			Vcnt	

Value	length(Bit)	Values and comments
arealD	16	ID of the detected frame 0 to 65535
dtctarea	16	0x0001 : Detection program 1 - Detection area 1 0x0002 : Detection program 1 - Detection area 2 0x0004 : Detection program 1 - Detection area 3 0x0008 : Detection program 1 - Detection area 4 0x0010 : Detection program 1 - Detection area 5 0x0020 : Detection program 1 - Detection area 6 0x0040 : Detection program 1 - Detection area 7 0x0080 : Detection program 1 - Detection area 8 0x0100 : Detection program 2 - Detection area 1 0x0200 : Detection program 2 - Detection area 2 0x0400 : Detection program 2 - Detection area 3 0x0800 : Detection program 2 - Detection area 4 0x1000 : Detection program 2 - Detection area 5 0x2000 : Detection program 2 - Detection area 6 0x4000 : Detection program 2 - Detection area 7 0x8000 : Detection program 2 - Detection area 8
almtype	4	Alarm status 0x01: Intruder detection 0x02: Loitering detection 0x03: Direction detection 0x05: Cross line detection 0x0F: Not alarmed
dir	4	Direction for Direction detection/Cross line detection 0x01 : Up 0x02 : Up-Right 0x03 : Right 0x04 : Down-Right 0x05 : Down 0x06 : Down-Left 0x07 : Left 0x08 : Up-Left 0x09 : A→B 0x0a : B→A 0x0b : A⇌B 0x00 : Not alarmed
almobj	8	Alarmed object 0x01 : Human 0x02 : Vehicle 0x03 : Bicycle
Hstart	16	X coordinate (Upper left) of the rectangle for the i-VMD object in 320x240 resolution.
Vstart	16	Y coordinate (Upper left) of the rectangle for the i-VMD object in 320x240 resolution.
Hcnt	16	Width of the rectangle for the i-VMD object (Horizontal) in 320x240 resolution

Vcnt	16	Height of the rectangle for the i-VMD object (Vertical) in 320x240 resolution
------	----	-------------------------------------------------------------------------------

AI-VMD information is refreshed every [100 milliseconds](#).

13.7. Location of meta information in each streams

13.7.1. H.264/H.265

RTP header

The data format of H.264/H.265 RTP header is described as follows. The meta information (additional information) are contained in the RTP header extensions.

H.264/H.265 RTP header

Byte	0.				8.			16.		24.	
	2	1	1	4	1	7		8		8	
0	V	P	X	CC	M	PT		Sequence number			
4	Timestamp										
8	SSRC (Synchronization Source Identifier)										
12	Defined by profile						Extension length				
16	meta information (Additional Information) (1)										
										
	meta information (Additional Information) (n)										

Header Extensions

13.7.2. JPEG

The meta information for JPEG is included after the comment marker of the image

The JPEG marker used by i-PRO camera is shown below.

Marker name		Marker code
SOI	Start Of Image	FF D8
APPn	Application segment	FF E0 - FF EF
DQT	Define Quantization Table	FF DB
SOF	Start of frame	FF C0
DHT	Define Huffman Table	FF C4
SOS	Start Of Scan	FF DA
EOI	End Of Image	FF D9
COM	Comment	FF FE

The meta information (Additional information) is included in the following place in JPEG image data.

[FF D8]
[FF FE]
[Length(byte order): 2byte(Include Length byte)] meta information (Additional information) (1) meta information (Additional information) (n)
[FF D8] JPEG image data (Not include comment field)
[FF D9]

[Note]

There is a setting (configuration) whether or not a camera attaches additional information to JPEG data. (There is the case that a camera does not add the additional data.)

14. Face detection

14.1. Face detection setup

[URL] /cgi-bin/set_face?vmdinfo=<Value>[&ch=<Value>]

[Method] POST

[Access level] 1

Parameter name	Value	Comments	Parameter to get current setting (/cgi-bin/getdata)
detect <input type="checkbox"/>	0, 1	Face detection setting. When the setting is set to ON, the camera sends the face detection information in the XML format and sends meta data in the image stream (Face detection information). 0: OFF 1: ON Default: 0	FACEDETECT
level	1 to 15	Detection sensitivity for the face detection 1(Low) to 15 (High) Default: 8	FACEDETECTSENSE

[Command example]

Configure the face detection setting to ON

http://192.168.0.10/cgi-bin/set_face?detect=1

14.2. XML notification setup

[URL] /cgi-bin/xml_alm[?<Parameter name>=<Value>]

[Method] POST

[Access level] 1

Parameter name	Value	Comments	Parameter to get current setting (/cgi-bin/getdata)
xml_alm	0, 1	XML notification setting (Destination 1) 0: OFF, 1: ON	XML
xml_interval	1, 2	Notification interval (Destination 1) 1: 1 sec 2: 2 sec	XMLINT
xml1_face_interval	1, 2, 3, 4, 5, 6, 10, 15, 20, 30, 60	Notification interval (Destination 1) 1 : 1 sec, 2 : 2 sec 3 : 3 sec, 4 : 4 sec 5 : 5 sec, 6 : 6 sec 10 : 10 sec, 15 : 15 sec 20 : 20 sec, 30 : 30 sec 60 : 1 min When 'Notification data' is set to 'Detection info.(Original)', the 'Notification interval' can only be set to '1s' or '2s'.	XML_FACEINT
xml1_data	0001, 0002	Notification data (Destination 1) 0001: Detection info.(Original) 0002: Detection info.(advanced)	XML_FACEDATA
xml2_alm	0, 1	XML notification setting (Destination 2) 0: OFF, 1: ON	XML2
xml2_face_interval	1, 2, 3, 4, 5, 6, 10, 15, 20, 30, 60	Notification interval (Destination 2) 1 : 1 sec, 2 : 2 sec 3 : 3 sec, 4 : 4 sec 5 : 5 sec, 6 : 6 sec 10 : 10 sec, 15 : 15 sec 20 : 20 sec, 30 : 30 sec 60 : 1 min When 'Notification data' is set to 'Detection info.(Original)', the 'Notification interval' can only be set to '1s' or '2s'.	XML2_FACEINT XML2_FACEDATA
xml2_data	0001, 0002	Notification data (Destination 2) 0001: Detection info.(Original) 0002: Detection info.(advanced)	XML2_FACEDATA
xml1_addr	<IPv4 address> or <IPv6 address> or <Host name>	IP address or hostname of the destination for XML notification (Destination 1) Default: None	XMLADDR1
xml1_port	1 to 65535	Destination port number for XML notification(Destination 1) Default: None	XMLPORT1

Parameter name	Value	Comments	Parameter to get current setting (/cgi-bin/getdata)
xml1_service	Characters	Destination directory to be used for the XML notification (Destination 1) Default: None	XMLSERVICENAME1
xml1_name	Characters	User name to be used for the XML notification (Destination 1) 0 to 32 characters Default: None	XMLUSER1
xml1_password	Characters	Password for 'xml1_name' to be used for the XML notification (Destination 1) 0 to 32 characters Default: None	-
xml2_addr	<IPv4 address> or <IPv6 address> or <Host name>	IP address or hostname of the destination for XML notification (Destination 2) Default: None	XMLADDR2
xml2_port	1 to 65535	Destination port number for XML notification(Destination 2) Default: None	XMLPORT2
xml2_service	Characters	Destination directory to be used for the XML notification (Destination 2) Default: None	XMLSERVICENAME2
xml2_name	Characters	User name to be used for the XML notification (Destination 2) 0 to 32 characters Default: None	XMLUSER2
xml2_password	Characters	Password for 'xm2_name' to be used for the XML notification (Destination 2) 0 to 32 characters Default: None	-

[Command example]

Configure the following setting for XML notification

- XML notification: ON
- Notification interval: 2s
- Destination 1 IP address: 192.168.0.100
- Destination 1 port number : 18200
- Destination 1 directory: test_dir
- Destination 1 user name: user1
- Destination 1 password : pass1

http://192.168.0.10/cgi-bin/xml_alm?xml_alm=1&xml_interval=2&xml1_addr=192.168.0.100&xml1_port=18200&xml1_service=test_dir&xml1_name=user1&xml1_password=pass1

14.3. XML notification for the face detection function

14.3.1. Abstract

The XML notification is a function to notify a server or others of face detection information in the XML format.

14.3.2. CGI to configure the setting relating to the XML notification

Refer to chapter 14.2 and 14.3

14.3.3. Protocol

14.3.3.1. Protocol type

The camera supports communications using HTTP(1.1) protocol for XML notification.

	item	protocol name	description
1	protocol	HTTP (1.1)	Use version 1.1 or later of HTTP protocol to use Keep-alive on http

14.3.3.2. Common elements of XML structure in the protocol

There are some common elements of XML structures in the camera XML protocol which are also used in other i-PRO devices. These common elements are **notification**, **panasonic-data**, and **event**. The following are the details of common elements:

1. The protocol requires one XML block called **<notification>**.

```
<notification>  
</notification>
```

2. The protocol requires one frame called **<panasonic-data>** within **<notification>** tag.

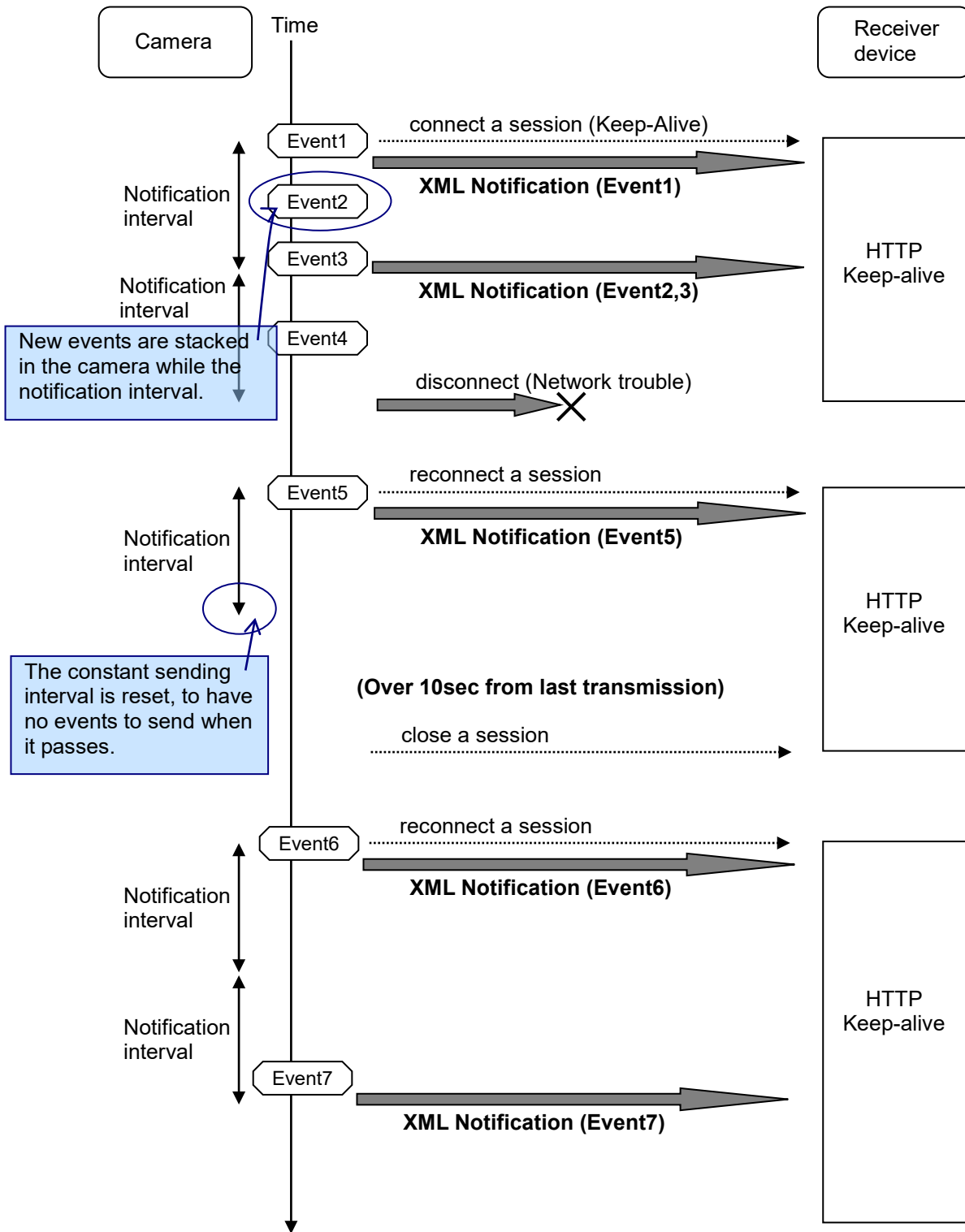
```
<notification>  
<panasonic-data>  
</panasonic-data>  
</notification>
```

3. The protocol requires one or more information elements called **<event>** within **<panasonic-data>** tag.

```
<panasonic-data>  
<event>  
</event>  
<event>  
</event>  
</panasonic-data>
```

14.3.4. Detail of the protocol

14.3.4.1. Sequence



14.3.4.2. HTTP request format

The camera uses POST method on HTTP protocol for sending XML data. The camera keeps a session by keep-alive mode(HTTP1.1) as long as it has more data for sending.

All detected messages stacked in sending interval are sent every interval time.

*Request example

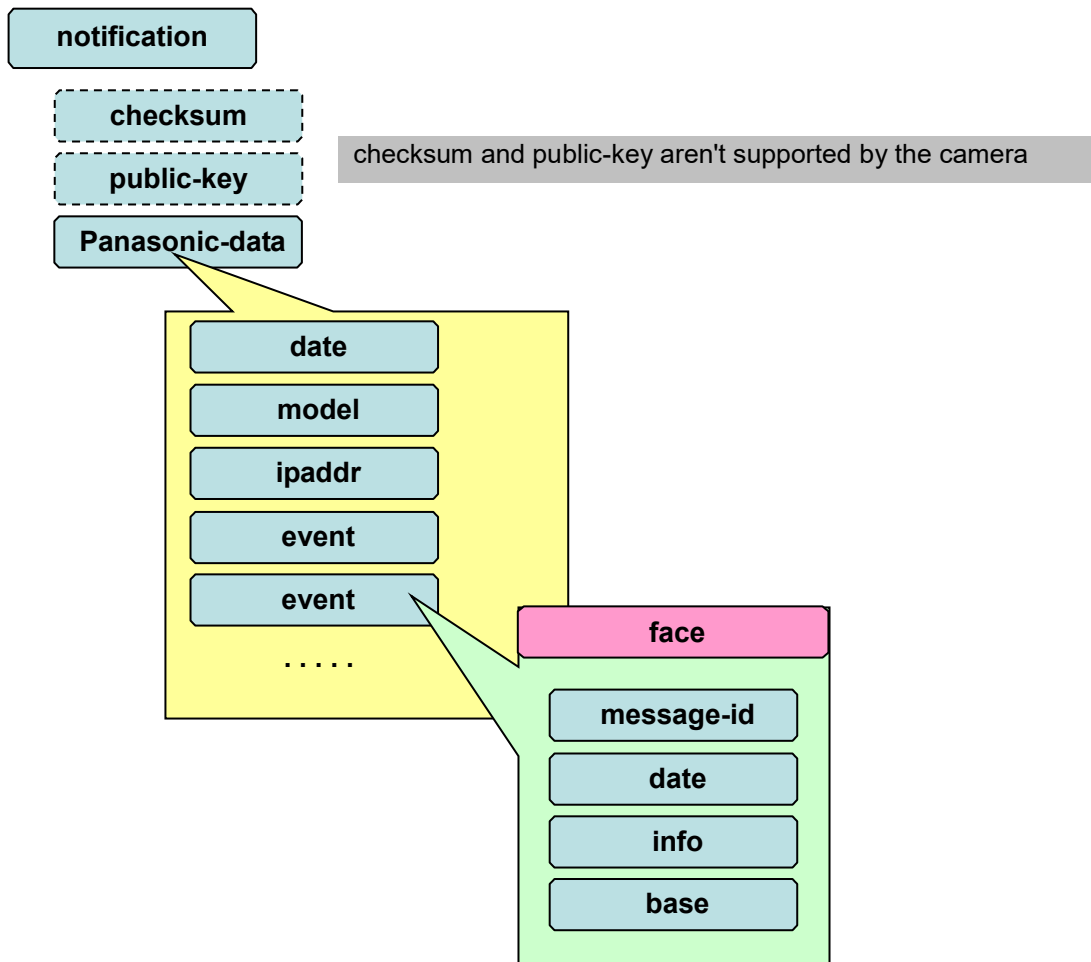
```
POST /** HTTP/1.1
Host: < ip address >
User-Agent: i-PRO Camera/1.0
Connection: Keep-Alive
Content-type: application/x-www-form-urlencoded
Content-Length: ?????
Authorization: Basic #####
```

```
-----
np502xml=
<notification>
  <panasonic-data>
    <event>
      detected information 1
    </event>
    <event>
      detected information 2
    </event>
    <event>
      detected information 3
    </event>
  </panasonic-data>
</notification>
-----
```

14.3.5. XML structure

14.3.5.1. XML structure

This is an outline of the XML structure. This figure shows XML tree structure of the camera.



14.3.5.2. XML data root block

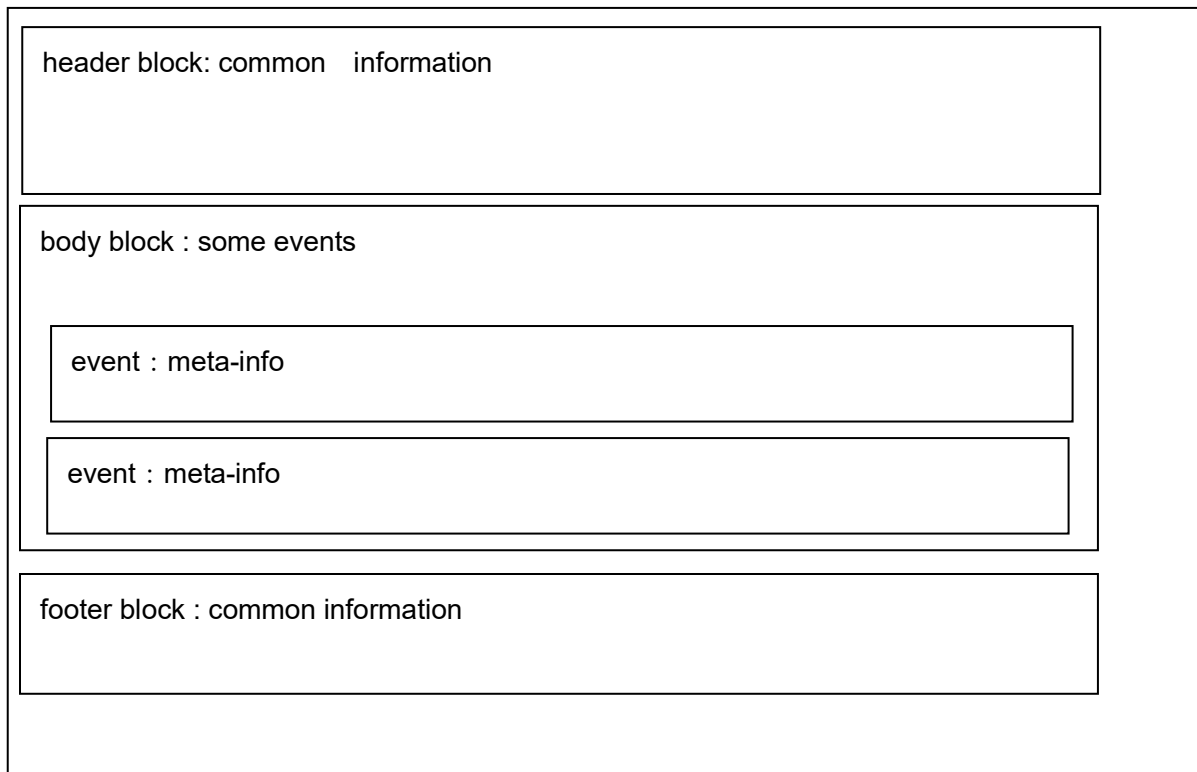
The common framework block of i-PRO XML structure is common in i-PRO security devices. This common framework block is located at the root node and its sub-elements which contains key tags of <notification>, <panasonic-data>, and <event>.

XML Structure(tree's top) is defined as the follow table.

	attribute	condition	description
1	notification	1	a notification tag can have 3 element types. <public-key> <checksum> <panasonic-data> The camera supported only "panasonic-data"
2	panasonic-data	1 or more in 1 XML block	a panasonic-data can have 1 or more events and some model common information.
3	event	1 or more in 1 notification block	they are ruled by event specification. this specification is our devices only

[Example figure]

On this figure sample 2 events in panasonic-data are included.



14.3.5.3. XML common

15.3.5.3.1 notification tag

This section describes the common framework block of i-PRO XML structure. The key tag of block, which is also the root element, is the <notification> tag. The details of this tag is described below.

	attribute	outline	Description
1	notification	XML structure	root node

15.3.5.3.2 Panasonic-data

This tag is root of camera component. The details will be described in next node.

	attribute	outline	Description
1	panasonic-data	XML structure	details in 4.3.1 panasonic-data

14.3.5.4. Panasonic-data common

15.3.5.4.1 Panasonic-data tag

This section describes the Panasonic-data element structure in the common frame block of Panasonic XML structure. The default of this tag is described below

	attribute	count	outline	description
1	vendor	1	Company	i-PRO
2	date	1	Transmission date	
3	model	1	Model	Model number
4	ipaddr	1	Network address	IP address
5	event	1 or more	Event information	

15.3.5.4.2 vender element

This element shows the vendor name of event detecting device.

	attribute	outline	style	description
*	(contents)	manufacture	i-PRO (Fixed)	

[Example]

```
<vendor>i-PRO</vendor>
```

15.3.5.4.3 date element

date element shows the transmission date from a device.

Y(year) M(month) D(day) h(hour) m(minute) s(second) sss(millisecond)

	attribute	outline	style	description
*	(contents)	Transmission date	YYYY/MM/DD hh:mm:ss.SSS	SSS 001msec-999msec *Display style for date is fixed in the Japanese style.
1	info		send (Fixed)	Date and time that

[Example]

```
<date info="send">2007/10/16 12:34:56.778</date>
```

15.3.5.4.4 model element

This element shows a model name of device.

	attribute	out line	style	description
*	(contents)	model name	Combinations of A-Za-z0-9:.-+	

[Example]

```
<model>WV-NP502</model> (English model)
```

15.3.5.4.5 ipaddr element

This element shows network IP address information and IP address version.

	attribute	outline	style	description
*	(contents)		ip address	
1	version	IP protocol version	IPv4 (Fixed)	IPv6 is not supported on NT314

[Example]

```
<ipaddr version="IPv4">192.168.0.1</ipaddr>
```

15.3.5.4.6 event element

	attribute	outline	style	description
1	type	event type	FACE (Fixed)	Face detection event
2	version	xml structure version	1.0 (Fixed)	
3	mode	output event type	basic (Fixed)	

[Example]

```
<event type="FACE" version="1.0" mode="basic">  
(FACE basic structure)  
</event>
```

14.3.5.5. event (FACE)

15.3.5.5.1 FACE tag

FACE event structure has 8 attributes as internal elements.

	attribute	style	description
1	message-id	event number	
2	date	detected time and date	
3	info	detected information	
4	base	base size of image	

15.3.5.5.2 message-id element

This element shows unique id as each event in the same network system.

	attribute	outline	style	description
1	(value)	message-id	YYYYMMDDhhmmss and . (dot) and serial number of four digits (0x0000 to 0xFFFF) and . (dot) and model number and @ and ipaddr	detect date and time serial number value of model element @ value of ipaddr element

[Example]

Date June. 06 2009 17:06:24
Serial number 003B
Model DG-NP502
IP address 192.168.0.21

<message-id>20090608170624.003B.DG-NP502@192.168.0.21</message-id>

15.3.5.5.3 date element

This element shows the detect time and date of event.

	attribute	outline	style	description
1	(contents)	date	YYYY/MM/DD hh:mm:ss.SSS	detect date and time YYYY: year MM : month DD: day hh: hour mm: minute ss: second SSS: millisecond *It is the time information that summertime and timezone value are reflected
2	info	detect	detect(fixed)	Kind at date
3	timezone	timezone	+hhmm or -hhmm	Time zone setting + / - : sign hh : Time zone hour mm : Time zone minute *When the setting is 00:00, it is omitted.
4	summertime	summertime Daylight saving time	on	Summertime (Daylight saving time) setting on : Summertime * When the setting is 'off', it is omitted.

[Example]

<date info="detect">2009/06/08 17:06:24.220</date>

15.3.5.5.4 info element

This element shows information detected face.

	attribute	outline	style	description
1	(contents)	XML structure		Information about the face detection
2	id	event ID	INTEGER	ID of detected face 0x0001 to 0x0008

	element	attribute	outline	style	description
1	detect				
		style	object shape	rect	This tag isn't supported by the camera.
	pos	x	X pos	INTEGER	X coordinate (Upper left) of the rectangle for the detected face in 320x240 resolution.
		y	Y pos	INTEGER	Y coordinate (Upper left) of the rectangle for the detected face in 320x240 resolution
	width		width	INTEGER	Width of the rectangle for the detected face (Horizontal) in 320x240 resolution
	height		height	INTEGER	Height of the rectangle for the detected face (Vertical) in 320x240 resolution

	element	attribute	outline	style	description
2	status				
	kentry		level	INTEGER	Level of confidence 1 to 15 1: Low confidence 15: High confidence
	kkaodir		direction	INTEGER	Direction of the detected face 0: Cannot recognized 1: front 2: lean toward 45 degree left side 3: 30 degree left direction 4: 75 degree left direction 5: lean toward 45 degree right side 6: 30 degree right direction 7: 75 degree right direction

[Example]

```

<info id="0001">
  <detect>
    <pos>
      <x>142</x>
      <y>45</y>
    </pos>
    <width>12</width>
    <height>12</height>
  </detect>
  <status>
    <kentry>7</kentry>
    <kkaodir>6</kkaodir>
  </status>
</info>

```

15.3.5.5.5 base element

This element shows base image information from face detection

	attribute	outline	style	description
*	(contents)	base image information	XML structure	Information about the face detection

	element	attribute	outline	style	description
1	base				
		width	width of image	320	Width of background image with detecting face
		height	height of image	240	Height of background image with detecting face

14.3.5.6. XML notification example

POST /*** HTTP/1.1
Host: 192.168.0.9
User-Agent: i-PRO Camera/1.0
Connection: Keep-Alive
Content-type: application/x-www-form-urlencoded
Content-Length: 874
Authorization: Basic #####

```
np502xml=  
<notification>  
  <panasonic-data>  
    <vendor>i-PRO</vendor>  
    <date info="send">2009/06/08 17:06:24.750</date>  
    <model>DG-NUP502</model>  
    <ipaddr version="IPv4">192.168.0.21</ipaddr>  
    <event type="FACE" version="1.0" mode="basic">  
      <message-id>20090608170624.003B.DG-NP502@192.168.0.21</message-id>  
      <date info="detect">2009/06/08 17:06:24.220</date>  
      <info id="0001">  
        <detect>  
          <pos>  
            <x>142</x>  
            <y>45</y>  
          </pos>  
          <width>12</width>  
          <height>12</height>  
        </detect>  
        <status>  
          <kentry>7</kentry>  
          <kkaodir>6</kkaodir>  
        </status>  
      </info>  
      <base>  
        <width>320</width>  
        <height>240</height>  
      </base>  
    </event>  
  </panasonic-data>  
</notification>
```

15. People count/Heat map/MOR (Moving Object Remover)

15.1. Overview

To work these functions, the optional software WV-SAE200 or WV-SAE303W is needed for the camera. WV-SAE303W support only People count. Information about people that make a U-turn is added to enhance accuracy.

[People count]

Camera counts the number of people which crossed the lines and stores the counting result to the SD memory card or internal memory as CSV files and index file (JPEG). These files can be acquired via FTP or http command. The result data can be acquired as additional information with H.264/H.265 and JPEG stream and so on. (Refer to chapter 13)

WV-SAE303W can output people count result that make a U-turn. When many people exist in the scene who make a U-turn, the accuracy of people count result can be enhanced by subtracting the number of people that e a U-turn from the number of people count.

The number of people count will be reset by "storing interval" setting.

[Heat map]

Camera counts the heat map information (counting / loitering) from the image which was divided to 64x64 blocks and the camera stores its result to the SD memory card or internal memory as CSV files and index file(JPEG).These files can be acquired via FTP or http command. The heat map result will be reset by "storing interval" setting.

[MOR (Moving Object Remover)]

It is a privacy-conscious function which removes people from the image and only send the background image(H.264/H.265,JPEG). (Refer to chapter 13)

15.2. Capability information

CGI: /cgi-bin/get_capability

Related response:

[video_server.video_analytics.<Parameter name>=<Value>](#)

Parameter name	Value	Comments
supported	yes, no	People count/ Heat map/ MOR function supported or not supported.
mode	people_count, heatmap, mor	Supported function among People count/ Heat map/ MOR function

15.3. People count, Heat map and MOR setting

[URL] /cgi-bin/set_ivmd_first? [<Parameter name>=<Value>]

[Method] GET/POST

[Access level] 1

Parameter name	Value	Comments	Parameter to get current setting(/cgi-bin/getdata)
kind	alm, info	Function type alm : i-VMD alarm mode info: People count/Heat map/MOR function mode	IVMDFUNCTIONTYPE
movcnt	0, 1	People count 0: Off, 1: On	IVMDPEOPLECOUNT
movmap	0, 1	Heat map 0: Off, 1: On	IVMDHEATMAP
rec_media	sd, internal	Destination of the storing information regarding Heat map and People count sd: SD memory card internal: Internal memory	IVMDDESTINATIONOFTHESTORINGINFORMATION
rec_interval	15, 60, 720, 1440	Storing interval of the number of people/ the heat map information 15: 15min 60: 1 hour 720: 12 hour 1440: 24 hour	IVMDINTERVALTOSTORE
rec_peg_quality	0, 1, 2, 3, 4, 5, 6, 7, 8, 9	Quality of the JPEG(Index image) 0 :means superfine, 1 :means fine, 2, 3, 4, 5 :means normal, 6, 7, 8, 9 :means low	-
bg	0, 1, 2	MOR (Moving Object Remover) 0: Off 1: H.264/H.265 2: JPEG	IVMDMOR
bg_img_sel	fisheye, panorama, ptz	Image type for MOR fisheye: fisheye panorama: Panorama or Double panorama ptz: QuadPTZ or Single PTZ	IVMDMORIMAGETYPE
bg_resolution	2048, 1920, 1280	Resolution for MOR 1920: 1920x1080 1600: 1600x1200 1280: 1280x1280 or 1280x960, 1280x720	IVMDIMAGECAPTURESIZE
bg_interval	1, 2, 3, 4, 5	Refresh interval of MOR 1: level 1(Slow) 2: level 2 3: level 3 4: level 4 5: level 5(Fast)	IVMDREFRESHINTERVAL

bg_montage	0, 1	Overlapping display for MOR 0: Off , 1: On	IVMDOVERLAPPINGDISPLAY
cam_layout	0, 1, 2, ,, 1000	Camera height 0: Off 1: Wall 2-1000: Ceiling (<Value>x0.01m)	IVMDSETTINGPOSITIONOFTHECAMERA

[Command examples]

People count: On

Information addition for people count: On

Destination of the storing information: SD memory card

Storing interval: 1 hour

http://192.168.0.10/cgi-bin/set_ivmd_first?kind=info&movcnt=1&movcnt_info=1&rec_media=sd&rec_interval=60

MOR ON : On

MOR Image type: Fisheye

MOR Resolution: 1280x1280

Refresh interval: Level2

Overlapping display: Off

http://192.168.0.10/cgi-bin/set_ivmd_first?kind=info&bg=1&bg_img_sel=fisheye&bg_resolution=1280&bg_interval=2&bg_montage=0

15.4. Line setting of the people count

[URL] /cgi-bin/set_movcnt? [<Parameter name>=<Value>]

[Method] GET/POST

[Access level] 1

Parameter name	Value	Comments	Parameter to get current setting (/cgi-bin/getdata)
det_fig1	21XXXXYYYYXXXXYYYY format	Coordinate information of people count line 1 1st XXXXYYYY means a starting point of the line, 2nd XXXX,YYYY means an end point of it. Both XXXXYYYY are decimal number. e.g.) Starting point: (120,130), End point: (240,222) 210120013002400222	IVMDPEOPLECOUNTLINE1AREA
det_fig2	(Same as above)	Coordinate information of people count line 2	IVMDPEOPLECOUNTLINE2AREA
det_fig3	(Same as above)	Coordinate information of people count line 3	IVMDPEOPLECOUNTLINE3AREA
det_fig4	(Same as above)	Coordinate information of people count line 4	IVMDPEOPLECOUNTLINE4AREA
det_fig5	(Same as above)	Coordinate information of people count line 5	IVMDPEOPLECOUNTLINE5AREA
det_fig6	(Same as above)	Coordinate information of people count line 6	IVMDPEOPLECOUNTLINE6AREA
det_fig7	(Same as above)	Coordinate information of people count line 7	IVMDPEOPLECOUNTLINE7AREA
det_fig8	(Same as above)	Coordinate information of people count line 8	IVMDPEOPLECOUNTLINE8AREA
det_fig9	(Same as above)	Coordinate information of people count line 9	IVMDPEOPLECOUNTLINE9AREA
det_fig10	(Same as above)	Coordinate information of people count line 10	IVMDPEOPLECOUNTLINE10AREA
det_fig11	(Same as above)	Coordinate information of people count line 11	IVMDPEOPLECOUNTLINE11AREA
det_fig12	(Same as above)	Coordinate information of people count line 12	IVMDPEOPLECOUNTLINE12AREA
det_fig1_stat	0, 1	line 1 enable/ disable 0: Disable, 1: Enable	IVMDPEOPLECOUNTLINE1STATUS
det_fig2_stat	(Same as above)	line 2 enable/ disable	IVMDPEOPLECOUNTLINE2STATUS
det_fig3_stat	(Same as above)	line 3 enable/ disable	IVMDPEOPLECOUNTLINE3STATUS
det_fig4_stat	(Same as above)	line 2 enable/ disable	IVMDPEOPLECOUNTLINE4STATUS
det_fig5_stat	(Same as above)	line 3 enable/ disable	IVMDPEOPLECOUNTLINE5STATUS
det_fig6_stat	(Same as above)	line 6 enable/ disable	IVMDPEOPLECOUNTLINE6STATUS
det_fig7_stat	(Same as above)	line 7 enable/ disable	IVMDPEOPLECOUNTLINE7STATUS
det_fig8_stat	(Same as above)	line 8 enable/ disable	IVMDPEOPLECOUNTLINE8STATUS
det_fig9_stat	(Same as above)	line 9 enable/ disable	IVMDPEOPLECOUNTLINE9STATUS
det_fig10_stat	(Same as above)	line 10 enable/ disable	IVMDPEOPLECOUNTLINE10STATUS
det_fig11_stat	(Same as above)	line 11 enable/ disable	IVMDPEOPLECOUNTLINE11STATUS
det_fig12_stat	(Same as above)	line 12 enable/ disable	IVMDPEOPLECOUNTLINE12STATUS

det_fig1_line	1, 2, 3	line1 direction 1: A→B 2: A←B 3: A←→B	IVMDPEOPLECOUNTLINE1DIRECTIONSETUP
det_fig2_line	(Same as above)	line2 direction	IVMDPEOPLECOUNTLINE2DIRECTIONSETUP
det_fig3_line	(Same as above)	line3 direction	IVMDPEOPLECOUNTLINE3DIRECTIONSETUP
det_fig4_line	(Same as above)	line4 direction	IVMDPEOPLECOUNTLINE4DIRECTIONSETUP
det_fig5_line	(Same as above)	line5 direction	IVMDPEOPLECOUNTLINE5DIRECTIONSETUP
det_fig6_line	(Same as above)	line6 direction	IVMDPEOPLECOUNTLINE6DIRECTIONSETUP
det_fig7_line	(Same as above)	line7 direction	IVMDPEOPLECOUNTLINE7DIRECTIONSETUP
det_fig8_line	(Same as above)	line8 direction	IVMDPEOPLECOUNTLINE8DIRECTIONSETUP
det_fig9_line	(Same as above)	line9 direction	IVMDPEOPLECOUNTLINE9DIRECTIONSETUP
det_fig10_line	(Same as above)	line10 direction	IVMDPEOPLECOUNTLINE10DIRECTIONSETUP
det_fig11_line	(Same as above)	line11 direction	IVMDPEOPLECOUNTLINE11DIRECTIONSETUP
det_fig12_line	(Same as above)	line12 direction	IVMDPEOPLECOUNTLINE12DIRECTIONSETUP

[Command example]

Line1: (120,130) (240,222), Direction: A→B

http://192.168.0.10/cgi-bin/set_movcnt?det_fig1=210120013002400222&det_fig1_stat=1&det_fig1_line=1

15.5. Download the CSV files

[URL] /cgi-bin/get_metadata? [<Parameter name>=<Value>]

[Method] GET

[Access level] 1

Parameter name	Value	Comments
kind	movcnt movcnt_info utncnt* utncnt_info* heatmap_mov heatmap_mov_info heatmap_loi heatmap_loi_info *WV-SAE303W only	Kind of the csv data movcnt: People count result and index images. movcnt_info: People count result utncnt: People count result who make a U-turn and index images. utncnt_info: People count result who make a U-turn heatmap_mov: Heat map information (count) and index images heatmap_mov_info: Heat map information (count) heatmap_loi: Heat map (loitering) information and index images. heatmap_loi_info: Heat map (loitering) information *This parameter can't be omitted
mode	range multi latest	Kind of response range: Get storing period multi: Get csv/index files by a date. latest: Get latest csv/index file *This parameter can't be omitted
year	(numerical value) (4 columns)	Date of the file to acquire (Year) *This parameter can't be omitted when the 'mode' parameter set to 'multi'.
month	1 - 12	Date of the file to acquire (Month) *This parameter can't be omitted when the 'mode' parameter set to 'multi'.
date	1 - 31	Date of the file to acquire (Date) *This parameter can't be omitted when the 'mode' parameter set to 'multi'.
hour	0 - 23	Date of the file to acquire (Hour) *This parameter can't be omitted when the 'mode' parameter set to 'multi'.
days	1 - 7	The days of the file to acquire *This parameter can't be omitted when the 'mode' parameter set to 'multi'.

[Command examples]

Getting the storing period of the people count result

http://192.168.0.10/cgi-bin/get_metadata?kind=movcnt&mode=range

Getting the People count result and index files of 5 days.

http://192.168.0.10/cgi-bin/get_metadata?kind=movcnt&mode=multi&year=2015&month=1&date=4&hour=7&days=5

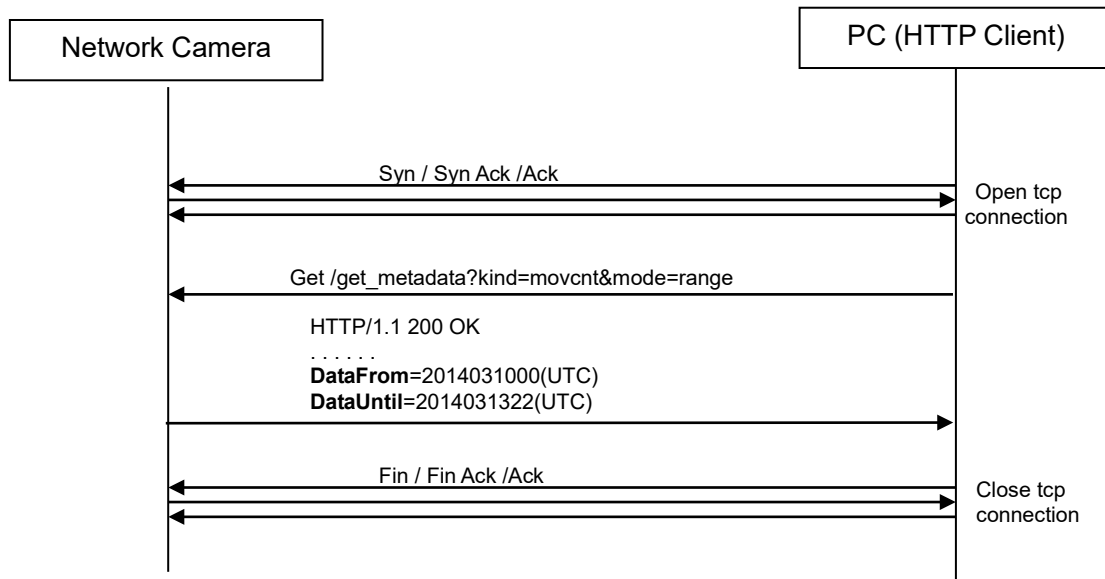
Getting the latest people count result and index files.

http://192.168.0.10/cgi-bin/get_metadata?kind=movcnt&mode=latest

15.6. Sequence of getting the CSV file

15.6.1. Get storing period (mode=range)

Sequence



Response format

```

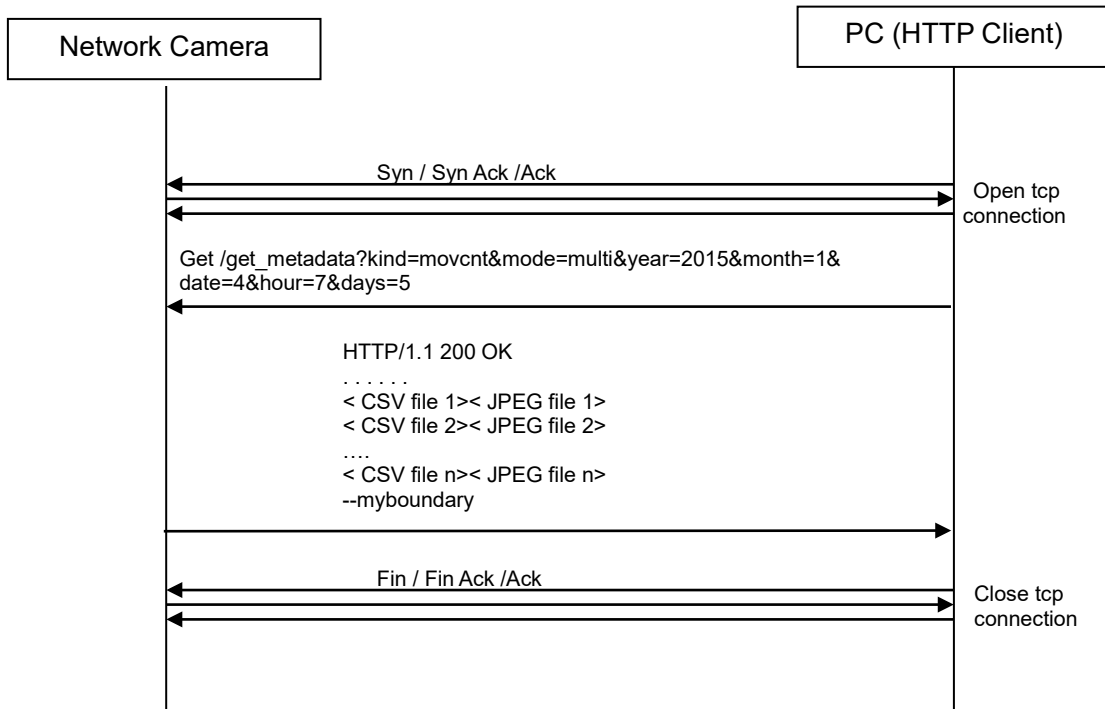
HTTP/1.1 200OK [CR] [LF]
Status 200[CR] [LF]
.....
Content-Length: xxxxx[CR] [LF]
DataFrom=YYYYMMDDHHmm(UTC) [CR] [LF]
DataUntil=YYYYMMDDHHmm(UTC) [CR] [LF]
[CR] [LF]
  
```

Response data

Data	Format	Description
DataFrom	YYYYMMDDHHmm(UTC) YYYY: year(4 columns) MM: month(2 columns) DD: day(2 columns) HH: hour(2 columns) mm: minute(2 columns)	Time and date of the oldest csv file (UTC time)
DataUntil	YYYYMMDDHHmm(UTC) YYYY: year(4 columns) MM: month(2 columns) DD: day(2 columns) HH: hour(2 columns) mm: minute(2 columns)	Time and date of the latest csv file (UTC time)

15.6.2. Get csv/index file by a date (mode=multi)

Sequence



Response format

(In case of kind=movcnt)

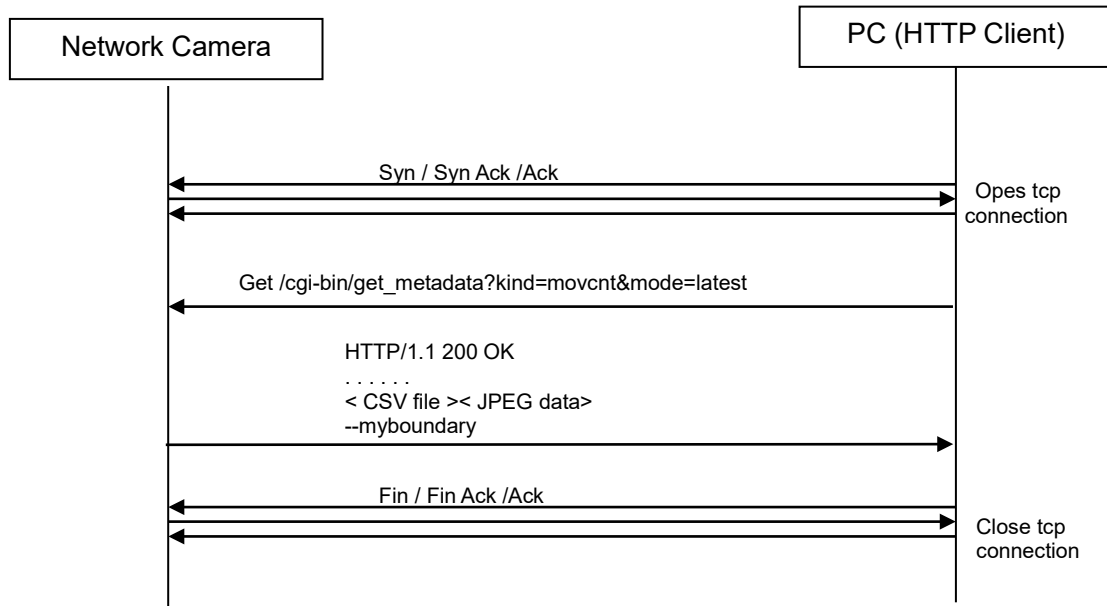
```
HTTP/1.1 200 OK[CR] [LF]
Status: 200[CR] [LF]
Connection: close[CR] [LF]
Content-type: multipart/form-data; boundary=myboundary[CR] [LF]
[CR] [LF]--myboundary[CR] [LF]
Content-Disposition: form-data; name="data" filename="mov_obj_cnt_YYYYMDDHMM_yyyymmddhmm.csv"[CR] [LF]
Content-Type: text/plain[CR] [LF] [CR] [LF]
Content-Length: xxxx[CR] [LF] [CR] [LF]
< CSV file 1 >
[CR] [LF]--myboundary[CR] [LF]
Content-Disposition: form-data; name="data" filename="index_YYYYMDDHMM_yyyymmddhmm.jpg"[CR] [LF]
Content-Type: image/jpeg[CR] [LF] [CR] [LF]
Content-Length: xxxx[CR] [LF] [CR] [LF]
< JPEG data 1 >
[CR] [LF]--myboundary[CR] [LF]
Content-Disposition: form-data; name="data" filename="mov_obj_cnt_YYYYMDDHMM_yyyymmddhmm.csv"[CR] [LF]
Content-Type: text/plain[CR] [LF] [CR] [LF]
Content-Length: xxxx[CR] [LF] [CR] [LF]
< CSV file 2 >
[CR] [LF]--myboundary[CR] [LF]
Content-Disposition: form-data; name="data" filename="index_YYYYMDDHMM_yyyymmddhmm.jpg"[CR] [LF]
Content-Type: image/jpeg[CR] [LF] [CR] [LF]
Content-Length: xxxx[CR] [LF] [CR] [LF]
< JPEG data 2 >
[CR] [LF]--myboundary[CR] [LF]
. . . . .
[CR] [LF]--myboundary[CR] [LF]
```

(In case of kind=movcnt_info)

```
HTTP/1.1 200 OK[CR] [LF]
Status: 200[CR] [LF]
Connection: close[CR] [LF]
Content-type: multipart/form-data; boundary=myboundary[CR] [LF]
[CR] [LF]--myboundary[CR] [LF]
Content-Disposition: form-data; name="data" filename="mov_obj_cnt_YYYYMDDHMM_yyyymmddhmm.csv"[CR] [LF]
Content-Type: text/plain[CR] [LF] [CR] [LF]
Content-Length: xxxx[CR] [LF] [CR] [LF]
< CSV file 1 >
[CR] [LF]--myboundary[CR] [LF]
Content-Disposition: form-data; name="data" filename="mov_obj_cnt_YYYYMDDHMM_yyyymmddhmm.csv"[CR] [LF]
Content-Type: text/plain[CR] [LF] [CR] [LF]
Content-Length: xxxx[CR] [LF] [CR] [LF]
< CSV file 2 >
[CR] [LF]--myboundary[CR] [LF]
. . . . .
[CR] [LF]--myboundary[CR] [LF]
```

15.6.1. Get latest csv/index file (mode=latest)

Sequence



Response format

(In case of kind=movcnt)

```
HTTP/1.1 200 OK[CR] [LF]
Status: 200[CR] [LF]
Connection: close[CR] [LF]
Content-type: multipart/form-data; boundary=myboundary[CR] [LF]
[CR] [LF]--myboundary[CR] [LF]
Content-Disposition: form-data; name="data" filename="mov_obj_cnt_latest.csv"[CR] [LF]
Content-Type: text/plain[CR] [LF] [CR] [LF]
Content-Length: xxxx[CR] [LF] [CR] [LF]
< CSV file >
[CR] [LF]--myboundary[CR] [LF]
Content-Disposition: form-data; name="data" filename="index_latest.jpg"[CR] [LF]
Content-Type: image/jpeg[CR] [LF] [CR] [LF]
Content-Length: xxxx[CR] [LF] [CR] [LF]
< JPEG data >
[CR] [LF]--myboundary[CR] [LF]
```

(In case of kind=movcnt_info)

```
HTTP/1.1 200 OK[CR] [LF]
Status: 200[CR] [LF]
Connection: close[CR] [LF]
Content-type: multipart/form-data; boundary=myboundary[CR] [LF]
[CR] [LF]--myboundary[CR] [LF]
Content-Disposition: form-data; name="data" filename="mov_obj_cnt_latest.csv"[CR] [LF]
Content-Type: text/plain[CR] [LF] [CR] [LF]
Content-Length: xxxx[CR] [LF] [CR] [LF]
< CSV file >
--myboundary[CR] [LF]
```

15.6.2. Error response

Error response:

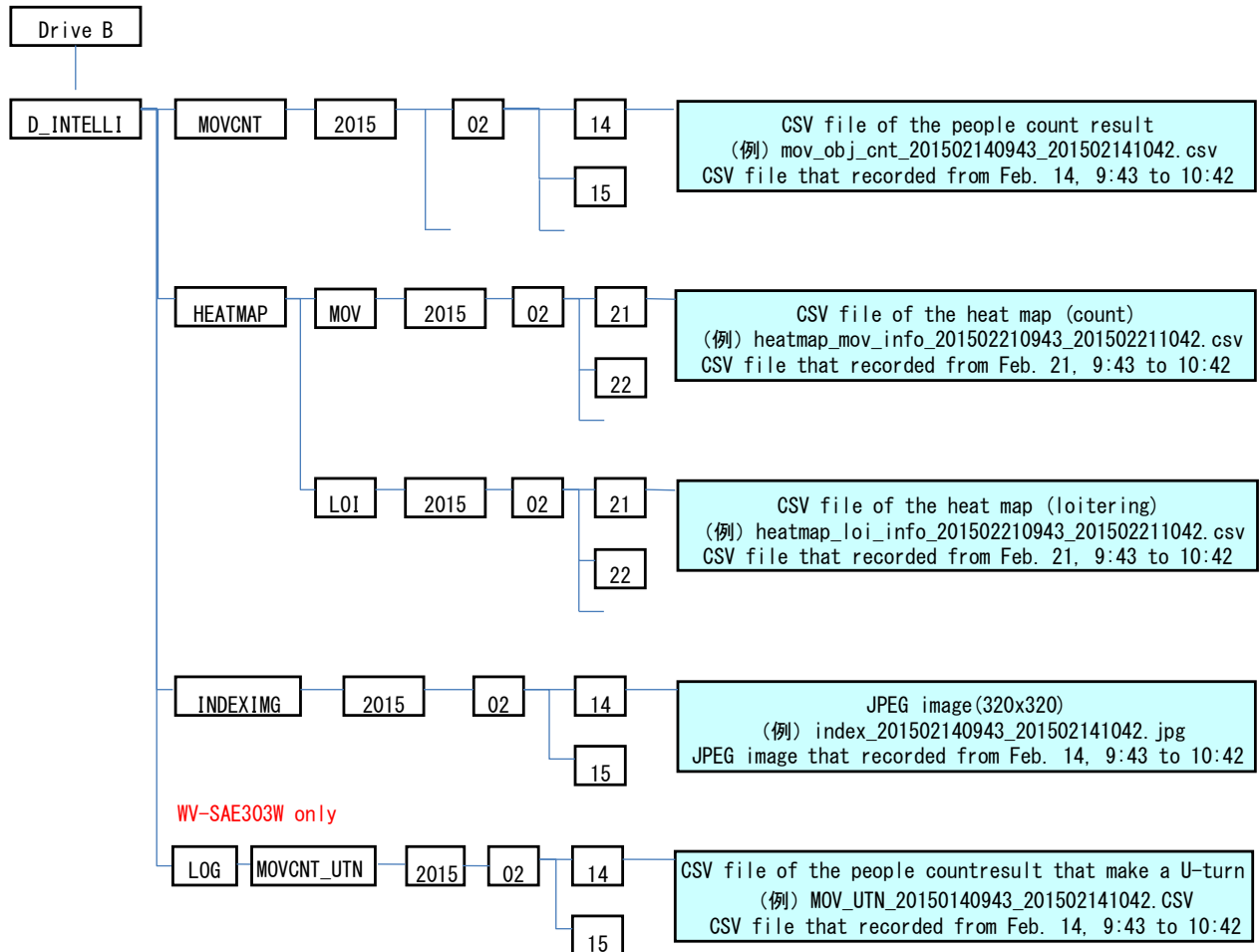
```
HTTP1.1 200OK [CR] [LF]
Status 200[CR] [LF]
. . . .
Content-Length: xxxxx[CR] [LF]
xxxxxxxxxx[CR] [LF]
[CR] [LF]
```

Kind of the error	Content of xxxxxxxxxxxx
A csv file doesn't exist.	No Data.
The function is set "Off" or any line isn't set.	No Data(1).
In preparation (approx. 5 min after starting the function.)	No Data(2).
Other errors	No Data(3).

15.7. Directory structure and file name

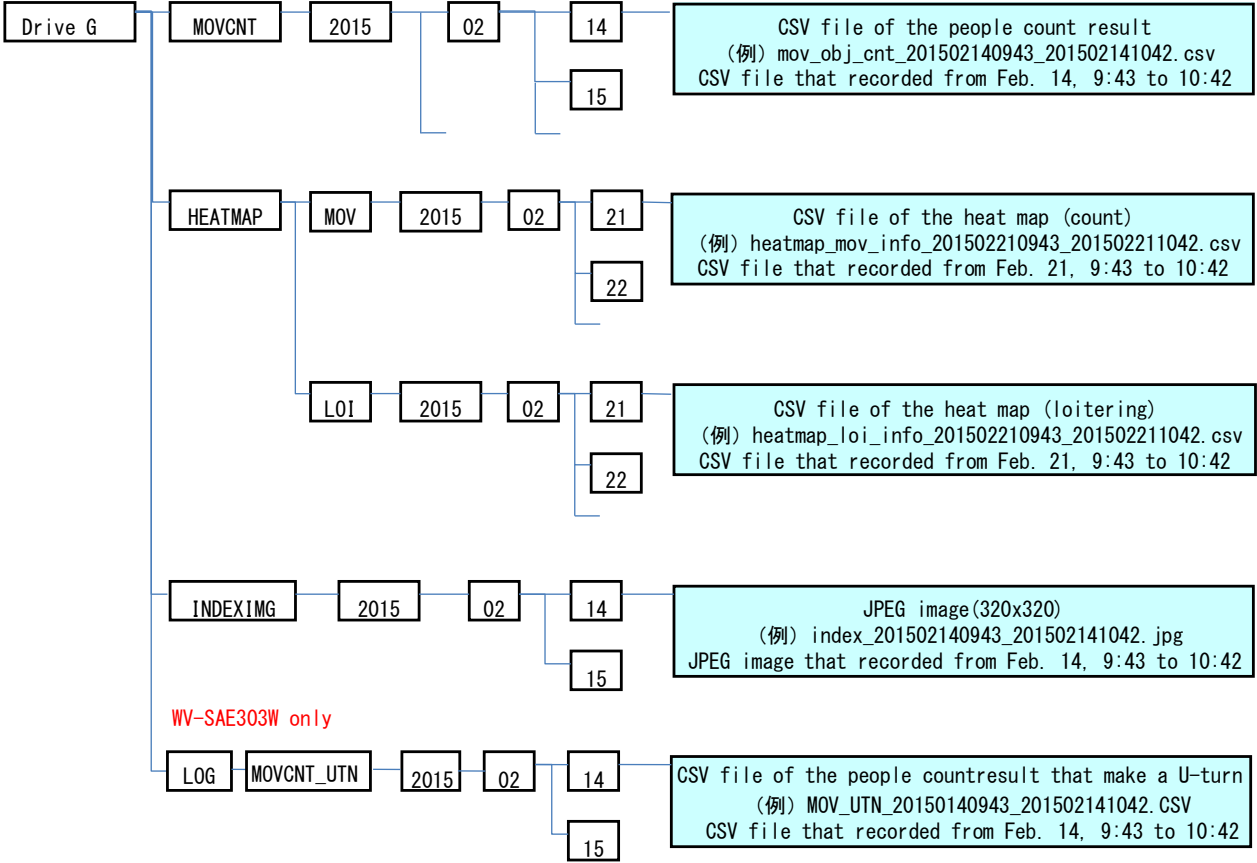
When the [Destination of the storing information] set to [SD memory card], CSV file and index file (JPEG) are stored in the SD memory card. The content of SD memory card can be seen as a drive B when using FTP

[CSV file and index file of the people count result and heat map information on the SD memory card.]



When the [Destination of the storing information] set to [Internal memory], CSV file and index file (JPEG) are stored in the internal memory of the camera, The content of internal memory can be seen as a drive G when using FTP

[CSV file and index file of the people count result and heat map information in the internal memory.]



15.8. CSV file format

15.8.1. People count

The following is a csv file format of the people count

The file format of people count who make a U-turn is the same with that of people count.

People count file includes the number of people who pass the designated line in a designated direction.

People count file who make a U-turn includes the number of people who make a U-turn.

```
s_yyyymmdd,s_hhmm,e_yyyymmdd,e_hhmm,p_hhmm,timezone,summertime
s_x1,s_y1,e_x1,e_y1,count_AB1,count_BA1
s_x2,s_y2,e_x2,e_y2,count_AB2,count_BA2
s_x3,s_y3,e_x3,e_y3,count_AB3,count_BA3
s_x4,s_y4,e_x4,e_y4,count_AB4,count_BA4
s_x5,s_y5,e_x5,e_y5,count_AB5,count_BA5
s_x6,s_y6,e_x6,e_y6,count_AB6,count_BA6
s_x7,s_y7,e_x7,e_y7,count_AB7,count_BA7
s_x8,s_y8,e_x8,e_y8,count_AB8,count_BA8
s_x9,s_y9,e_x9,e_y9,count_AB9,count_BA9
s_x10,s_y10,e_x10,e_y10,count_AB10,count_BA10
s_x11,s_y11,e_x11,e_y11,count_AB11,count_BA11
s_x12,s_y12,e_x12,e_y12,count_AB12,count_BA12
```

Data	Format	Description
s_yyyymmdd	YYYYMMDD YYYY: year(4 columns) MM: month(2 columns) DD: day(2 columns)	Time and date that the camera started to count the number of people from in this csv. (year/month/day) UTC time
s_hhmm	HHmm HH: hour(2columns) mm: minute(2 columns)	Time and date that the camera started to count the number of people from in this csv. (hour/minute) UTC time
e_yyyymmdd	YYYYMMDD YYYY: year(4 columns) MM: month(2 columns) DD: day(2 columns)	Time and date that the csv was closed by. (year/month/day) UTC time
e_hhmm	HHmm HH: hour(2columns) mm: minute(2 columns)	Time and date that the csv was closed by. (hour/minute) UTC time
p_hhmm	HH:mm HH: hour(2columns) mm: minute(2 columns)	Storing interval of the number of people e.g.) In case of 15min-> 00:15
timezone	-12:00 to +12:00 (6 columns)	timezone
summertime	IN, OUT	summertime IN: Daylight saving time (Summertime) OUT: Not daylight saving time

s_x1	0 to 319	X coordinate of the starting point (Line1)
s_y1	0 to 319	Y coordinate of the starting point (Line1)
e_x1	0 to 319	X coordinate of the ending point (Line1)
e_y1	0 to 319	Y coordinate of the ending point (Line1)
count_AB1	0 to 65535	Counting result of the number of people. Direction A→B (Line1)
count_BA1	0 to 65535	Counting result of the number of people. Direction B→A (Line1)

* The above descriptions are common in other lines (s_x2, s_y2,,,, e_x12, e_y12).

* When a line wasn't set, both coordinates information set to (0, 0).

15.8.2. Heat map

The following is a csv file format of the heat map

```
s_yyyymmdd,s_hhmm,e_yyyymmdd,e_hhmm,p_hhmm,timezone,summertime
info(1,1),info(2,1),info(3,1), ..., info(63,1),info(64,1)
info(1,2),info(2,2),info(3,2), ..., info(63,2),info(64,2)
info(1,3),info(2,3),info(3,3), ..., info(63,3),info(64,3)

, , , , , , ,
, , , , , , ,
info(m,n),info(m,n),info(m,n), ..., info(m,n),info(m,n)
, , , , , , ,

info(1,63),info(2,63),info(3,63), ..., info(63,63),info(64,63)
info(1,64),info(2,64),info(3,64), ..., info(63,64),info(64,64)
```

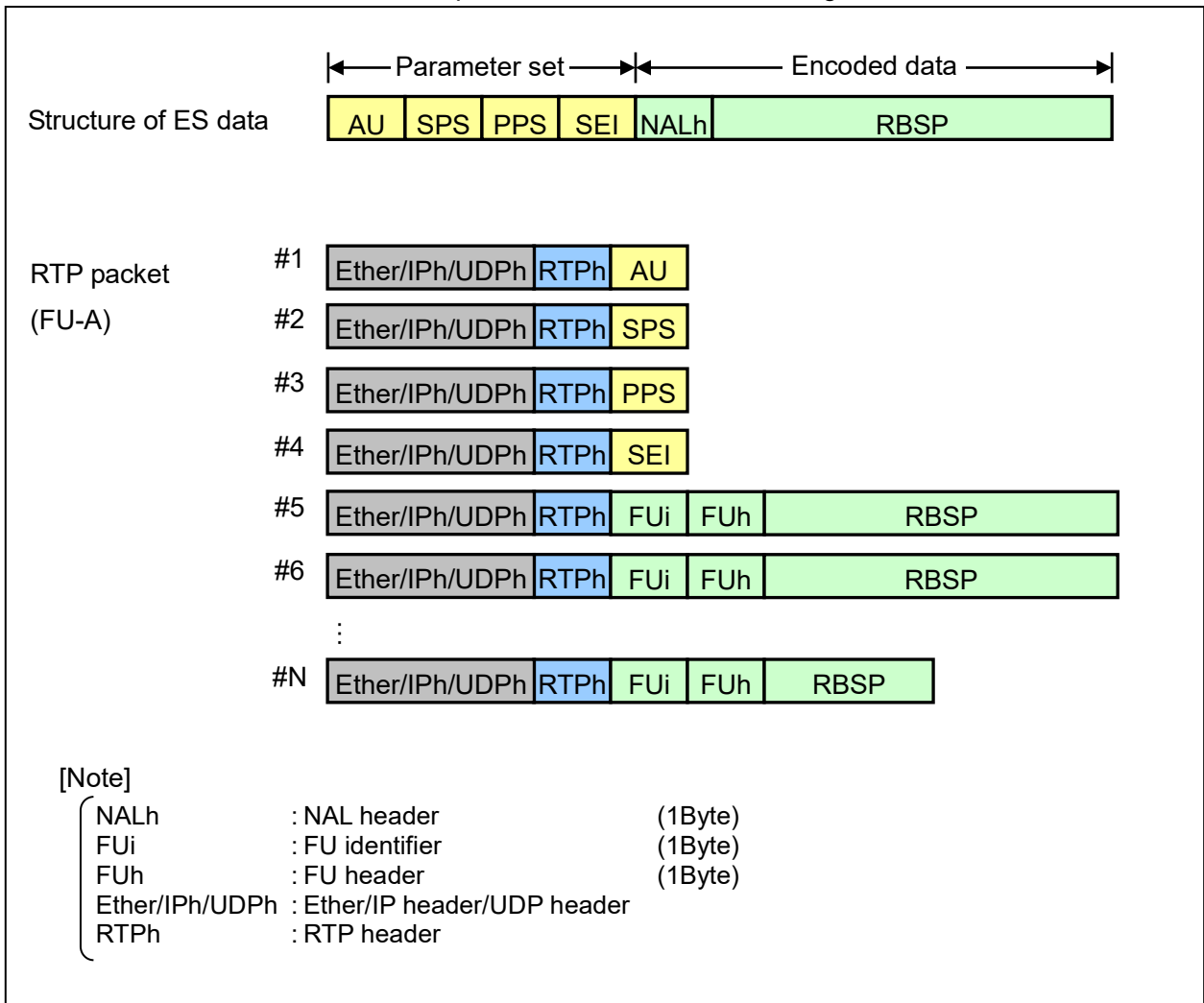
Data	Format	Description
s_yyyymmdd	YYYYMMDD YYYY: year(4 columns) MM: month(2 columns) DD: day(2 columns)	Time and date that the camera started to count the heat map information from in this csv. (year/month/day) UTC time
s_hhmm	HHmm HH: hour(2columns) mm: minute(2 columns)	Time and date that the camera started to count the heat map information from in this csv. (hour/minute) UTC time
e_yyyymmdd	YYYYMMDD YYYY: year(4 columns) MM: month(2 columns) DD: day(2 columns)	Time and date that the csv was closed by. (year/month/day) UTC time
e_hhmm	HHmm HH: hour(2columns) mm: minute(2 columns)	Time and date that the csv was closed by. (hour/minute) UTC time
p_hhmm	HH:mm HH: hour(2columns) mm: minute(2 columns)	Storing interval of the heat map information e.g.) In case of 15min-> 00:15
timezone	-12:00 to +12:00 (6 columns)	timezone
summertime	IN, OUT	summertime IN: Daylight saving time (Summertime) OUT: Not daylight saving time
info(m,n)	0 to 65535	Heat map information of (m, n)

16. Appendix

16.1. H.264 data format

16.1.1. H.264 data and RTP packet

The structure of ES data and RTP packet for H.264 data streaming are described as below.



- The above figure describes the case of the IDR picture. "SPS" isn't included in case of P picture.

16.1.1.1. Mode that removes AU/SEI/PPS from H.265/H.264 stream

[URL] /cgi-bin/setdata2? [<Parameter name>=<value>]

[Method] POST

[Access level] 1

Parameter name	value	Comments	Parameter that supports setting value obtainment CGI (/cgi-bin/getdata)
NAL_UNIT	aud, non_aud	aud: AU/SEI/PPS are provided non_aud: AU/SEI/PPS are removed	nal_unit

16.1.1.2. Mode that removes all AU/SEI/PPS/SPS

[URL] /cgi-bin/setdata? [<Parameter name>=<value>]

[Method] POST

[Access level] 1

Parameter name	value	Comments	Parameter that supports setting value obtainment CGI (/cgi-bin/getdata)
H264NONALFLG	0, 1	0: AU/SEI/PPS/SPS are provided 1: AU/SEI/PPS/SPS are removed	H264NONALFLG

16.1.2. RTP header format

H.264 RTP header

Byte	0.				8.			16.	24.
	2	1	1	4	1	7	8	8	
0	V	P	X	CC	M	PT	Sequence number		
4	Timestamp								
8	SSRC (Synchronization Source Identifier)								
12	Defined by profile					Extension length			
16	Additional Information (1)								
								
	Additional Information (n)								

Parameter name	length(Bit)	Values and comments
V (Version)	2	2 (fixed)
P (Padding)	1	0 (fixed)
X (Extension)	1	0: false , 1: true (TBD)
CC (CSRC Count)	4	0 (fixed)
M (Marker)	1	In case of the last RTP packet of a picture, this value is set to 1
PT (Payload Type)	7	98 (fixed)
Sequence number	16	The value in which one increment is done in each RTP packet is set. An initial value is generated at random.
Timestamp	32	Time stamp
SSRC	32	0x0000 0000 (fixed)
CSRC	0	Unused
Defined by profile(*)	16	0 (fixed)
Extension length(*)	16	Length of the Header Extension (Unit of 32bit word)
meta information (Additional Information) (*)		Refer to chapter 13

16.2. H.265 data format

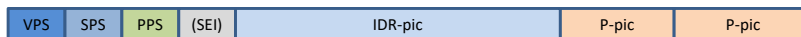
16.2.1. Data format

H.265 supports normal mode and Long term mode.

If the stream is set to Long term mode, the additional information is added in RTP header (Refer to 13.6.9)

NALU(Network Abstraction Layer Unit)

VPS,SPS,PPS and (SEI) are added in IDR-pic. P-pic does not have addition.



Reference Picture Mode

Normal Mode

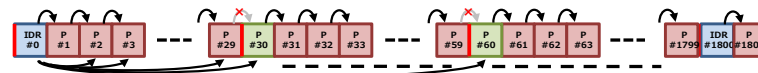
Structured by P-pic that refers to only IDR pic and just before pic.



Long-Term Mode

Refer to two plane which are IDR pic and just before pic.

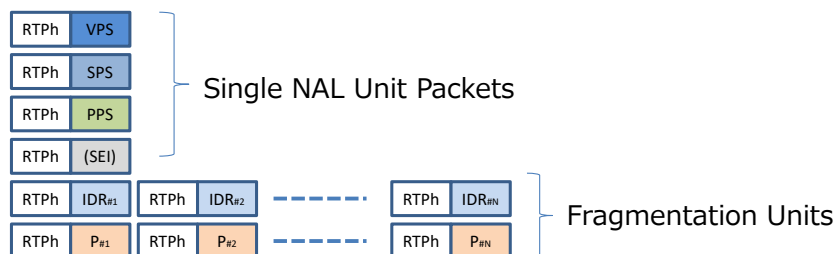
However Key frame (P#30,#60,,) which refers only IDR is periodically inserted. ※IDR interval : 60sec, Key frame interval : 1sec



※ Key frame can be decode if IDR is existing, and it is possible to improve random accessibility. In case of showing #61, it can be decoded by IDR#0, P#60, P#61.

RTP Format

In case of RTP send, it will be sent by Single NAL Unit Packets or Fragmentation Units



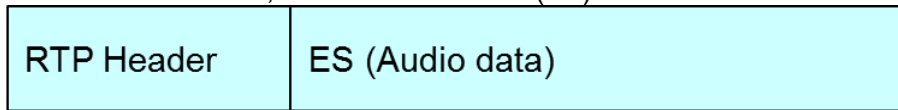
16.3. Audio data format

16.3.1. Audio data and RTP packet

Structure of the audio ES data and the RTP packet depends on the audio encoder setup.

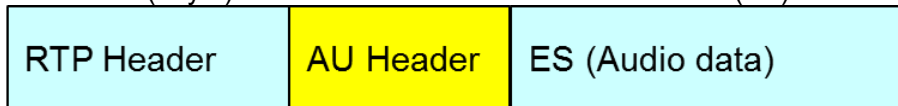
[Case of 'G.726' or 'G.711' stream]

After the RTP header, send the audio data (ES).



[Case of 'AAC-LC']

AU header (2byte) is between RTP header and audio data (ES).



16.3.2. RTP header format

RTP header

Byte	0.				8.			16.	24.
	2	1	1	4	1	7	8	8	
0	V	P	X	CC	M	PT	Sequence number		
4	Timestamp								
8	SSRC (Synchronization Source Identifier)								
12	Defined by profile						Extension length		
16	Additional Information (1)								
								
	Additional Information (n)								

Parameter name	length(Bit)	Values and comments
V (Version)	2	2 (fixed)
P (Padding)	1	0 (fixed)
X (Extension)	1	0: false , 1: true (TBD)
CC (CSRC Count)	4	0 (fixed)
M (Marker)	1	In case of the last RTP packet of a picture, this value is set to 1
PT (Payload Type)	7	98 (fixed)
Sequence number	16	The value in which one increment is done in each RTP packet is set. An initial value is generated at random.
Timestamp	32	Time stamp
SSRC	32	0x0000 0000 (fixed)
CSRC	0	Unused
Defined by profile(*)	16	0 (fixed)
Extension length(*)	16	Length of the Header Extension (Unit of 32bit word)
meta information (Additional Information) (*)		Refer to chapter 13

16.3.3. Audio stream format (HTTP)

Data format of G.726 (HTTP with JPEG) stream transmission (ex. 32kbps) is shown below.
*It is described [CR] as 0x0d and [LF] as 0x0a, [NUL] as 0x00.

HTTP/1.0 200 OK[CR][LF]
Content-type: multipart/x-mixed-replace;boundary=--myboundary[CR][LF]
[CR][LF]--myboundary[CR][LF]
Content-type: audio/g.726-32k[CR][LF]
Content-length: *****[CR][LF][CR][LF]
[NUL]
G.726 data 1
[CR][LF]--myboundary[CR][LF]
Content-type: audio/g.726-32k[CR][LF]
Content-length: *****[CR][LF][CR][LF]
[NUL]
G.726 data 2
[CR][LF]--myboundary[CR][LF]
...
[CR][LF]--myboundary[CR][LF]
Content-type: audio/g.726-32k[CR][LF]
Content-length: *****[CR][LF][CR][LF]
[NUL]
G.726 data N
[CR][LF]--myboundary[CR][LF]
Content-type: audio/g.726-32k[CR][LF]
Content-length: *****[CR][LF][CR][LF]
[NUL]
G.726 data N+1
...

In "Content-length:", data length of g.726 to be transmitted is set.

16.4. JPEG data format

16.4.1. Data format of JPEG and audio stream transmission JPEG stream format

HTTP/1.1 200 OK[CR][LF]
Connection: close[CR][LF]
Content-type: multipart/x-mixed-replace;boundary=--myboundary[CR][LF]
[CR][LF]--myboundary[CR][LF]
Content-type: image/jpeg[CR][LF]
Content-length: *****[CR][LF][CR][LF]
JPEG image 1([FFD8] to [FFD9])
[CR][LF]--myboundary[CR][LF]
Content-type: image/jpeg[CR][LF]
Content-length: *****[CR][LF][CR][LF]
JPEG image 2([FFD8] to [FFD9])
[CR][LF]--myboundary[CR][LF]
...
[CR][LF]--myboundary[CR][LF]
Content-type: image/jpeg[CR][LF]
Content-length: *****[CR][LF][CR][LF]
JPEG image N([FFD8] to [FFD9])
[CR][LF]--myboundary[CR][LF]
Content-type: image/jpeg[CR][LF]
Content-length: *****[CR][LF][CR][LF]
JPEG image N+1([FFD8] to [FFD9])
...

In "Content-length:", data length of JPEG image to be transmitted is set. (From FFD8 to FFD9)

JPEG marker

Marker name	Marker code	
SOI	Start Of Image	FF D8
APPn	Application segment	FF E0 - FF EF
DQT	Define Quantization Table	FF DB
SOF	Start of frame	FF C0
DHT	Define Huffman Table	FF C4
SOS	Start Of Scan	FF DA
EOI	End Of Image	FF D9
COM	Comment	FF FE