

Overview

- 4 Megapixel IR
- True WDR 120dB
- 2.8mm Lens
- Built-In Mic
- H.265
- Indoor Camera





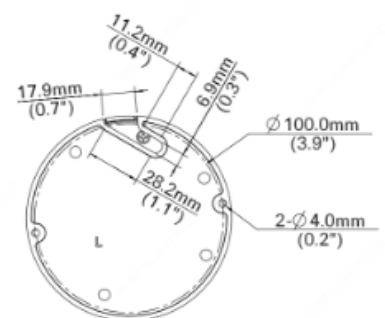
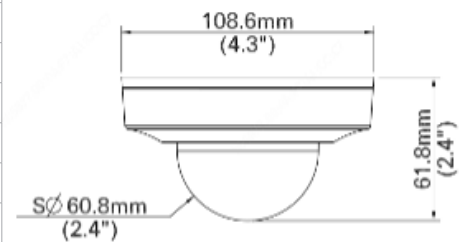

Technical Specifications

Device	
Image Sensor:	1/3" Progressive Scan CMOS
Min Illumination:	Color: 0.01Lux (F2.0, AGC ON) 0Lux with IR
Shutter Time:	Auto/Manual, 1 ~ 1/100000s
Lens:	2.8mm@F2.0
WDR:	120 dB
Angle of View:	H: 95.8°, V: 55.2°, 124.5°
Angle Adjustment:	Pan: 3° ~ 360° Tilt: 0° ~ 68° Rotate: 3° ~ 360°
3-Axis Adjustment:	Yes
Day & Night:	IR-Cut Filter with Auto Switch (ICR)
IR Range:	Up to 30m (98ft) IR range
Compression Standard	
Video Compression:	H.265, H.264, MJPEG
Video Bit Rate:	128 Kbps~16 Mbps
Tri-Stream:	Yes
Analytics:	Intrusion, Human Body Detection, Motion Detection, Tampering Alarm, Audio Detection
Image	
Max. Image Resolution:	2688 x 1520
Frame Rate:	30fps (2688 x 1520)
ROI Codec:	Up to 2 areas
Image Setting:	White Balance, Digital Noise Reduction, Smart IR, Flip, HLC, BLC



Technical Specifications

Network	
Alarm Channels:	1 Channel In 1 Channel Out
Protocols:	IPv4, IGMP, ICMP, ARP, TCP, UDP, DHCP, RTP, RTSP, RTCP, DNS, DDNS, NTP, FTP, UPnP, HTTP, HTTPS, SMTP, SSL, QoS
Interface	
Communication Interface:	10M/100M Base-TX Ethernet
Local Storage:	Micro SD, up to 256GB
Audio:	Input: Impedance 35kΩ; Amplitude 2V [p-p] Output: Impedance 600Ω; Amplitude 2V [p-p]
General	
Safety	UL (IEC60950-1), CE, IEC62368-1
EMC	FCC (Part15 ClassA), EN55032 ClassB, EN55024
Operating Conditions:	Temperature: -35°C ~ 60°C (-31°F ~ 140°F), Humidity: ≤95% RH (Non-Condensing)
Power Consumption:	Max 5.5W
Power Supply:	DC 12V±25%, PoE (IEEE 802.3af)
Weather Proof Rating:	–
Vandal Resistant:	–
Dimensions:	Φ108.6 x 61.8mm (Ø4.28" x 2.43")
Weight:	0.22kg (0.49lb)
Software:	Includes Video Insight VMS License
Accessories	<div style="display: flex; justify-content: space-around; align-items: flex-start;"> <div style="text-align: center;"> <p>M-JB-MINI</p>  </div> <div style="text-align: center;"> <p>M-WM-JB-MINI</p>  </div> <div style="text-align: center;"> <p>M-PM</p>  </div> </div> <div style="display: flex; justify-content: space-around; align-items: flex-start; margin-top: 20px;"> <div style="text-align: center;"> <p>M-Pendant-Ex</p>  </div> <div style="text-align: center;"> <p>M-Pendant</p>  </div> </div>

R011322 | Product specifications and availability are subject to change without notice.

Panasonic i-PRO Sensing Solutions Co., Ltd. i-PRO, Viewnetcam.com, FacePRO, Advidia, VideoInsight, Arbitrator, CloUDE, and Unified Digital Evidence are registered trademarks or trademarks of Panasonic i-PRO Sensing Solutions Co., Ltd. or Panasonic i-PRO Sensing Solutions Corporation of America in various jurisdictions. All other trademarks are the property of their respective owners.