

WV-U61301-Z1

2MP (1080p) 10x Indoor PTZ Network Camera

U series PTZ camera

i-PRO releases 10 base models with a diverse lineup including a low-cost range of compact PTZ. The newly added compact size PTZ camera

can be discreetly installed in low ceilings, which was previously difficult to manage.

It achieves the industry's highest level of drive durability to withstand high-speed and high-frequency camera movement by the automatic monitoring function.



- 2MP (1080p) 1920x1080
- 10x optical zoom
- Intelligent Auto
- Super Dynamic 144dB
- Color night vision (0.001 to 0.015 lx)
- Durable Pan/Tilt gear mechanism
- Built-in FIPS 140-2 Level 3 Certified Secure Element
(EdgeLock® SE050F NXP® Semiconductors)
- NDAA Compliant

SPECIFICATIONS

Camera	
Image Sensor	Approx. 1/2.8 type CMOS image sensor
Minimum Illumination	Color : 0.015 lx (50IRE, F1.6, 1/30s) , Color : 0.001 lx (50IRE, F1.6, 16/30s) BW : 0.006 lx (50IRE, F1.6, 1/30s) , BW : 0.0004 lx (50IRE, F1.6, 16/30s)
White Balance	ATW1 / ATW2 / AWC
Shutter Speed	[60 fps Mode] 1/60 Fix to 1/10000 Fix, [30 fps/15 fps mode] 1/30 Fix to 1/10000 Fix [50 fps Mode] 1/50 Fix to 1/10000 Fix, [25 fps/12.5 fps mode] 1/25 Fix to 1/10000 Fix
Intelligent Auto	On / Off
Super Dynamic	On / Off, the level can be set in the range of 0 to 31.
Dynamic Range	Max.144 dB (Super Dynamic : On, Level 31)
Adaptive Black Stretch	The level can be set in the range of 0 to 255.
Back light compensation / High light compensation	BLC (Back light compensation) / HLC (High light compensation) / Off The level can be set in the range of 0 to 31 (only when Super dynamic / Intelligent Auto : Off)
Fog compensation	On / Off, The level can be set in the range of 0 to 8 (only when Intelligent auto / auto contrast adjust : Off)
Maximum gain (AGC)	The level can be set in the range of 0 to 11.
Color/BW (ICR)	Off / On / Auto1 / Auto2 / Auto3 (SCC)
Digital Noise Reduction	The level can be set in the range of 0 to 255.
Video Motion Detection (VMD)	On / Off, 4 areas available
Scene Change Detection (SCD)	On / Off, 1 areas available
Audio Detection	On / Off
AI Sound Classification	—
AI Analytics	—
Privacy Zone	On / Off, Up to 32 zones available
VIQS	On / Off, Up to 8 zones available
Image Stabilizer	On / Off (Built-in gyro sensor)
Camera Title (OSD)	On / Off, Up to 40 characters (alphanumeric characters, marks)
Focus Adjustment	Auto focus
Lens	
Optical zoom	10x (Motorized zoom / Motorized Focus)
Extra zoom	Max. 15x (10 to 15x : When resolution is 1280 x 720)
Focal Length	4.7 – 47 mm {3/16 inches - 1-27/32 inches}
Angular Field of View	[16 : 9 mode] Horizontal : 6.7° (TELE) – 62° (WIDE), Vertical : 3.8° (TELE) – 37° (WIDE) [4 : 3 mode] Horizontal : 5.1° (TELE) – 48° (WIDE), Vertical : 3.8° (TELE) – 37° (WIDE)
Maximum Aperture Ratio	1 : 1.6 (WIDE) – 1 : 3.0 (TELE)
Focus Range	1.5 m {59-1/16 inches} – ∞
DORI	
Detect (25ppm / 8ppf)	Wide: 64.2m / 210.5 ft, Tele: 656.0 m / 2152.3 ft
Observe (62.5ppm / 19ppf)	Wide: 25.7 m / 84.2 ft, Tele: 262.4 m / 860.9 ft

Recognize (125ppm / 38ppf)	Wide: 12.8 m / 42.1 ft, Tele: 131.2 m / 430.5 ft
Identify (250ppm / 76ppf)	Wide: 6.4m / 21.1 ft, Tele: 65.6 m / 215.2 ft

System on Chip (SoC)

System on Chip (SoC)	Ambarella CV25M
----------------------	-----------------

Adjusting Angle

Adjusting Angle	Horizontal : 0 to +350°, Vertical : -30 to +90°, Yaw : 0°
-----------------	---

Pan/tilt

Panning Range	0° – 350°
Panning Speed	Manual: Approx. 0.065°/s – 150°/s , Preset: Up to approx. 500°/s
Tilting Range	Operational -30° – +90°
Tilting Speed	Manual: Approx. 0.065°/s –150°/s , Preset: Up to approx. 350°/s
Preset Positions	256 positions
Auto Mode	Auto pan/ Preset sequence/ Patrol
Self Return	10 s/ 20 s/ 30 s/ 1 min/ 2 min/ 3 min/ 5 min/ 10 min/ 20 min/ 30 min/ 60 min

Browser GUI

Camera Control	Brightness, AUX On / Off
Audio	Mic (Line) Input : On / Off Volume adjustment : Low / Middle / High Audio Output : On / Off Volume adjustment : Low / Middle / High
GUI / Setup Menu Language	English, Italian, French, German, Spanish, Portuguese, Russian, Chinese, Japanese
Browser	Microsoft Edge, Firefox, Google Chrome

Network

Network IF	10 Base-T / 100 Base-TX, RJ45 connector
Resolution H.265/ H.264 JPEG (MJPEG)	[16 : 9 mode (60 fps mode)] , [16 : 9 mode (30 fps mode)], [16 : 9 mode (50 fps mode)] , [16 : 9 mode (25 fps mode)] : 1920x1080, 1280x720, 640x360, 320x180 [4 : 3 mode (30 fps mode)], [4 : 3 mode (25 fps mode)] : 1280x960, VGA, QVGA [4 : 3 mode (15 fps mode)], [4 : 3 mode (12.5 fps mode)] : 2048x1536 , 1280x960, VGA, QVGA
H.265/H.264	[Transmission Mode] Constant bit rate / VBR / Frame rate / Best effort [Transmission Type] Unicast port (AUTO) / Unicast port (MANUAL) / Multicast
JPEG	[Image Quality] 10 steps
Smart Coding	GOP (Group of pictures) control: Off/ Low (Variable GOP 1s-8s)/ Mid (Variable GOP 4s-16s)/ Advanced(Fixed GOP 60s w/1s key-frame) / Frame rate control (Variable GOP 4s-16s with frame rate control) *Advanced and Frame rate control are only available with H.265. Smart Coding: Auto VIQS: On/Off
Audio Compression	G.726 (ADPCM) : 16 kbps / 32 kbps , G.711 : 64 kbps , AAC-LC : 64 kbps / 96 kbps / 128 kbps
Audio Transmission Mode	Off / Mic (Line) input / Audio output / Interactive (Half duplex) / Interactive (Full duplex)
Supported Protocol	IPv6 : TCP/IP, UDP/IP, HTTP, HTTPS, SSL/TLS, SMTP, DNS, NTP, SNMPv1/v2/v3, DHCPv6, RTP, MLD, ICMP, ARP, IEEE 802.1X, DiffServ, SFTP, MQTT, LLDP IPv4 : TCP/IP, UDP/IP, HTTP, HTTPS, SSL/TLS, RTSP, RTP, RTP/RTCP, SMTP, DHCP, DNS, DDNS, NTP, NMPv1/v2/v3, UPnP, IGMP, ICMP, ARP, IEEE 802.1X, DiffServ, SRTP, SFTP, MQTT, LLDP, NTCIP
No. of Simultaneous Users	Up to 14 users (Depends on network conditions)
Secure	FIPS 140-2 level 3 Certified Secure Element (NXP® EdgeLock® SE050F), Device Certificate GlobalSign® pre-installed, User authentication, Host authentication, HTTPS, 802.1X Support, Data encryption
SDXC/SDHC/SD Memory Card (Option)	H.265 / H.264 recording : Manual REC / Alarm REC (Pre/Post) / Schedule REC / Backup upon network failure JPEG recording : Manual REC / Alarm REC (Pre/Post) / Backup upon network failure Compatible SDXC/SDHC/SD Memory Card : microSDXC memory card : 64 GB, 128 GB, 256 GB, 512 GB microSDHC memory card : 4 GB, 8 GB, 16 GB, 32 GB , microSD memory card : 2 GB

Mobile Terminal Compatibility	iPad, iPhone (iOS 8.0 or later), Android™ terminals
ONVIF® Profile	G / S / T
Alarm	
Alarm Source	3 terminals input, VMD alarm, Command alarm, Audio detection alarm
Alarm Actions	SDXC/SDHC/SD memory recording, E-mail notification, HTTP alarm notification Indication on browser, TCP alarm notification output
Input/Output	
Audio Input	ø3.5 mm stereo mini jack For microphone input : Recommended applicable microphone : Plug-in power type (Sensitivity of microphone : -51 dB to -38 dB (0 dB=1 V/Pa, 1 kHz)) Input impedance : Approx. 2 kΩ (unbalanced) / Supply voltage : 2.5 V ±0.5 V For line input : Input level : Approx. -10 dBV
Audio Output	ø3.5 mm stereo mini jack (monaural output) Output impedance : Approx. 600 Ω (unbalanced) , Output level : -20 dBV
External I/O Terminals	ALARM IN 1 (Alarm input 1/ Black & white input/ Auto time adjustment input) (x1) ALARM IN 2 (Alarm input 2/ ALARM OUT) (x1), ALARM IN 3 (Alarm input 3/ AUX OUT) (x1)
Safety	UL (UL62368-1), c-UL (CSA C22.2 No.62368-1), CE, IEC62368-1
EMC	FCC (Part15 ClassA), ICES-003 Issue 7 ClassA, EN55032 ClassA, EN55035
Power Source and Power Consumption	DC12 V, PoE (IEEE802.3af) , DC12 V: 970 mA / Approx. 11.6 W PoE DC 48 V: 270 mA / Approx.12.95 W (Class 0 device)
Ambient Operating Temperature	-10 °C to +50 °C (+14 °F to +122 °F) (Power On range : 0 °C to +50 °C {+32 °F to +122 °F})
Ambient Operating Humidity	10 to 90 % (no condensation)
Anti-Condensation System	—
Dimensions	ø117 mm x 155 mm (H) {ø4-19/32 inches x 6-3/32 inches (H)}
Mass (Approx.)	Approx. 1.2 kg {2.65 lbs.}
Finish	Main body : Resin, i-PRO white

NOTES

Important

- Safety Precautions : Carefully read the Basic Information, Installation Guide and Operating Instructions before using this product.
- i-PRO Co., Ltd. cannot be held responsible for the performance of the network and/or other manufacturers' products used on the network.
- Masses and dimensions are approximate. Specifications are subject to change without notice.

Trademarks and registered trademarks

- iPad and iPhone are trademarks of Apple Inc., registered in the U.S. and other countries. - Android is a trademark of Google LLC.
- ONVIF is a trademark of ONVIF, Inc.
- All other trademarks identified herein are the property of their respective owners

©i-PRO Co., Ltd All rights reserved / November 2022

OPTIONAL ACCESSORIES

Select a compatible accessory

[Accessory Selector \(i-pro.com\)](http://i-pro.com).



WV-Q105A
Mount Bracket



WV-QCL100-W
Mount Bracket



WV-QCL101-W
Mount Bracket



WV-QCN500-W
Mount Bracket



WV-QED100C-W
Ceiling Mount Bracket



WV-QED100G-W
Ceiling Mount Bracket



WV-QJB500-W
Mount Bracket



WV-QPL500-W
Mount Bracket



WV-QWD100C-W
Wall Mount Bracket



WV-QWD100G-W
Wall Mount Bracket



WV-QWL500-W
Mount Bracket



WV-QAT100
Inner Cover



WV-QCD100C-W
Dome Cover



WV-QCD100G-W
Dome Cover



WV-PM500
Compact microphone
unit for surveillance
cameras

APPEARANCE

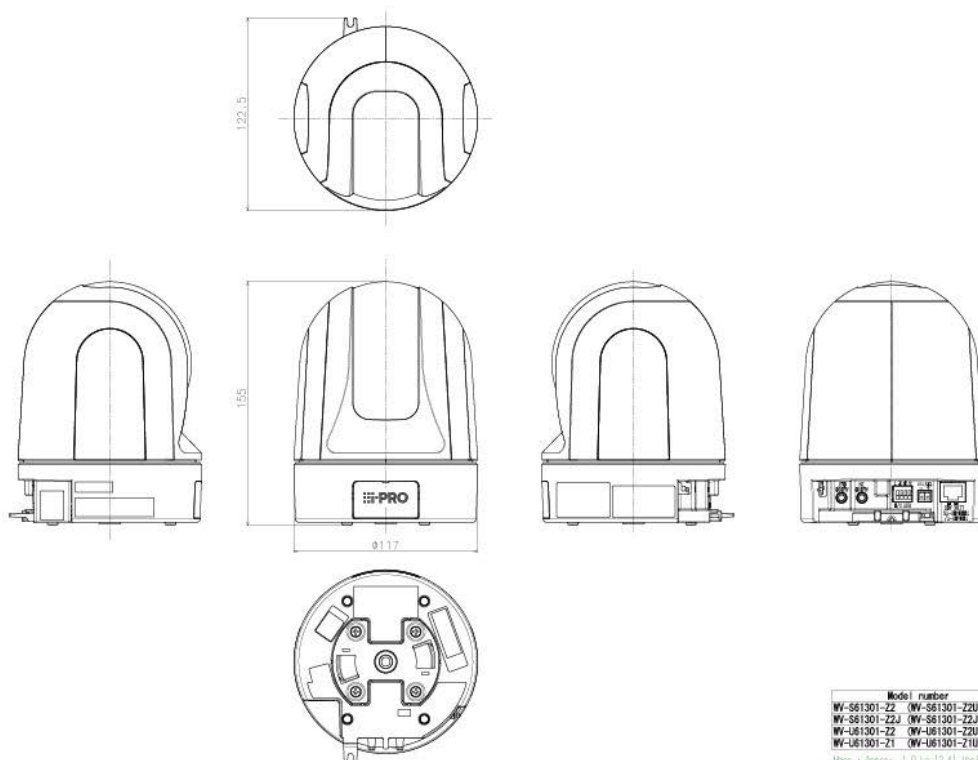

Model number	Lens type
WV-S61301-22 (WV-S61301-22US)	x21
WV-S61301-22J (WV-S61301-22JUS)	
WV-U61301-22 (WV-U61301-22US)	x10
WV-U61301-21 (WV-U61301-21US)	

Mass : Approx. 1.0 kg (2.21 lbs)

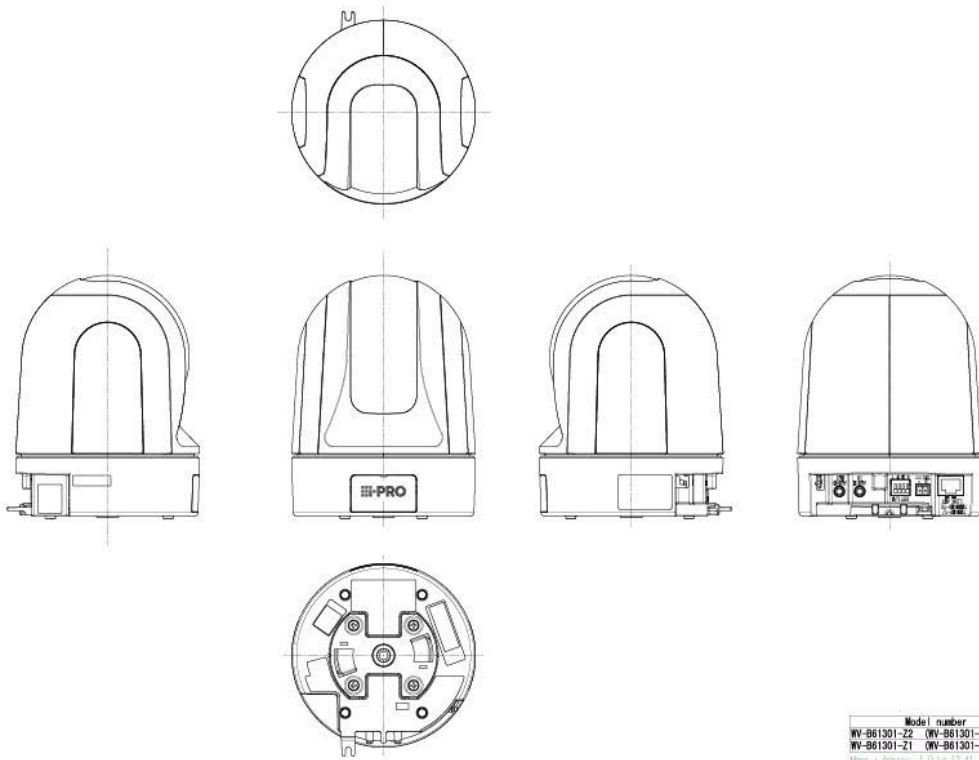

Model number	Lens type
WV-861301-Z2 (WV-861301-Z2US)	x21
WV-861301-Z1 (WV-861301-Z1US)	x10

Mass : Approx. 1.0 kg (2.21 lbs)

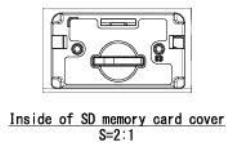

Inside of SD memory card cover
S=2:1

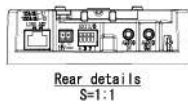

Rear details
S=1:1

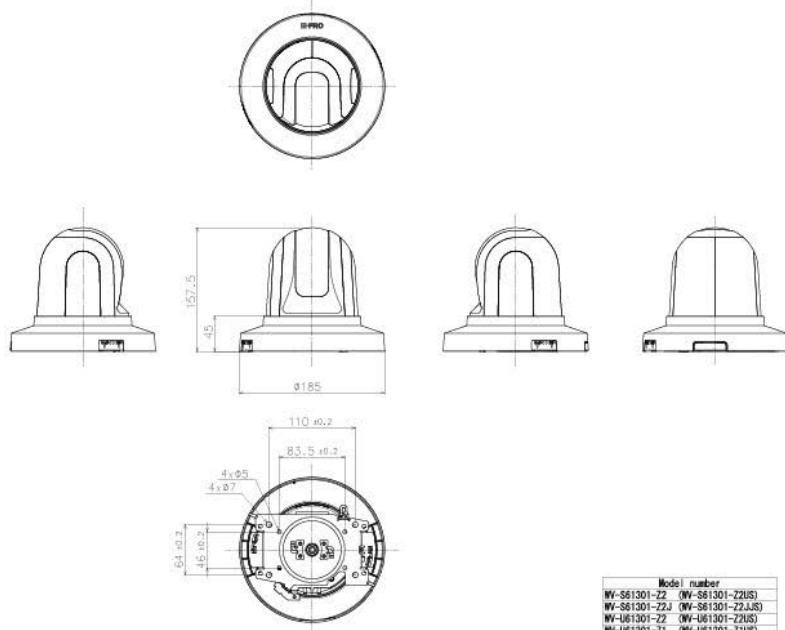

With Decorative cover & Camera mount bracket

Model number
WV-861301-Z2 (WV-861301-Z2US)
WV-861301-Z2J (WV-861301-Z2JUS)
WV-061301-Z2 (WV-061301-Z2US)
WV-061301-Z1 (WV-061301-Z1US)
WV-861301-Z2 (WV-861301-Z2US)
WV-861301-Z1 (WV-861301-Z1US)

Mass : Approx. 1.2 kg (2.65 lbs)
(Including Decorative cover and Camera mount bracket)

金具との組み合わせ例
Example of combination with bracket

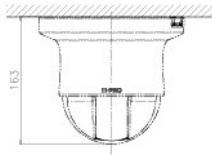

Attach to WV-QCD100C-W

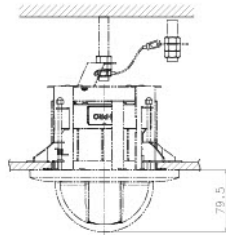

Attach to WV-QED100C-W

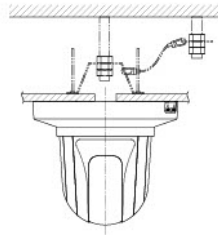

Attach to WV-QAT105A

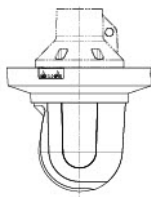

Attach to WV-QCL100-W

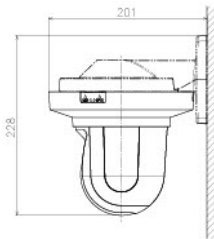

Attach to WV-QWL500-W

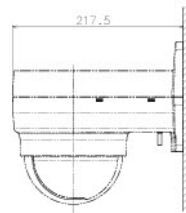

Attach to WV-QWD100C-W

Model number	
WV-S61301-ZZ	(WV-S61301-ZZUS)
WV-S61301-ZZJ	(WV-S61301-ZZJUS)
WV-U61301-ZZ	(WV-U61301-ZZUS)
WV-U61301-Z1	(WV-U61301-Z1US)
WV-B61301-ZZ	(WV-B61301-ZZUS)
WV-B61301-Z1	(WV-B61301-Z1US)