

||·PRO

Basic Information

Network Camera

Model No. **WV-S2536LTN**
WV-S2536LN
WV-S2536L

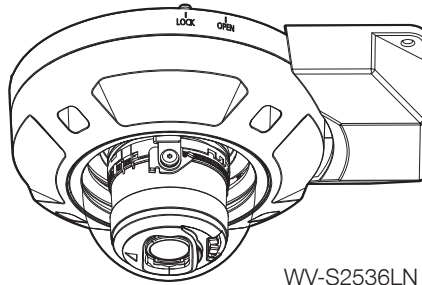

WV-S2536LN

About the user manuals

Product documentation is composed of the following documents.

- **Installation Guide (accessory):** Provides information about “Precautions”, “Precautions for installation” and the installation method.
- **Basic Information (this document):** Provides information about “Precautions for use”, “Parts and functions” and “Detail specifications”.
- **Operating Instructions (in the following manual website):** Explains how to perform the settings and how to operate this camera.
https://i-pro.com/global/en/surveillance/documentation_database

“<Control No.: C****>” used in these documents should be used to search for information on our support website (https://i-pro.com/global/en/surveillance/training_support/support/technical_information) and will guide you to the right information.

- microSDXC/ microSDHC/ microSD memory card is described as microSD memory card.
- The external appearance and other parts shown in this manual may differ from the actual product within the scope that will not interfere with normal use due to improvement of the product.



Contents

Limitation of liability.....	3
Disclaimer of warranty.....	3
About notations.....	4
System requirements for a PC.....	4
Network security.....	5
Precautions for use.....	6
Parts and functions.....	9
Insert / remove a microSD memory card.....	14
Troubleshooting.....	16
Detail specifications.....	18

Limitation of liability

THIS PUBLICATION IS PROVIDED “AS IS” WITHOUT WARRANTY OF ANY KIND, EITHER EXPRESS OR IMPLIED, INCLUDING BUT NOT LIMITED TO, THE IMPLIED WARRANTIES OF MERCHANTABILITY, FITNESS FOR ANY PARTICULAR PURPOSE, OR NON-INFRINGEMENT OF THE THIRD PARTY’S RIGHT.

THIS PUBLICATION COULD INCLUDE TECHNICAL INACCURACIES OR TYPOGRAPHICAL ERRORS. CHANGES ARE ADDED TO THE INFORMATION HEREIN, AT ANY TIME, FOR THE IMPROVEMENTS OF THIS PUBLICATION AND/OR THE CORRESPONDING PRODUCT (S).

Disclaimer of warranty

IN NO EVENT SHALL i-PRO Co., Ltd. BE LIABLE TO ANY PARTY OR ANY PERSON, EXCEPT FOR REPLACEMENT OR REASONABLE MAINTENANCE OF THE PRODUCT, FOR THE CASES, INCLUDING BUT NOT LIMITED TO BELOW:

- (1) ANY LOSS OR DAMAGE, INCLUDING WITHOUT LIMITATION, DIRECT OR INDIRECT, SPECIAL, CONSEQUENTIAL OR EXEMPLARY, ARISING OUT OF OR RELATING TO THE PRODUCT;
- (2) ANY INCONVENIENCE, LOSS, OR DAMAGE CAUSED BY INAPPROPRIATE USE OR NEGLIGENT OPERATION OF THE USER;
- (3) ALL MALFUNCTIONS OR TROUBLES FROM UNAUTHORIZED DISASSEMBLE, REPAIR OR MODIFICATION OF THE PRODUCT BY THE USER, REGARDLESS OF THE CAUSE OF THE MALFUNCTION OR TROUBLE;
- (4) INCONVENIENCE OR ANY LOSS ARISING WHEN IMAGES ARE NOT DISPLAYED, DUE TO ANY REASON OR CAUSE INCLUDING ANY FAILURE OR PROBLEM OF THE PRODUCT;
- (5) ANY PROBLEM, CONSEQUENTIAL INCONVENIENCE, OR LOSS OR DAMAGE, ARISING OUT OF THE SYSTEM COMBINED BY THE DEVICES OF THIRD PARTY;
- (6) ANY CLAIM OR ACTION FOR DAMAGES BROUGHT BY ANY PERSON OR ORGANIZATION AS A PHOTOGRAPHED SUBJECT DUE TO VIOLATION OF PRIVACY CONCERNING A SURVEILLANCE CAMERA’S PICTURE OR SAVED DATA, FOR SOME REASON (INCLUDING USE WHEN USER AUTHENTICATION ON THE AUTHENTICATION SETTING SCREEN IS SET TO OFF), BECOMING PUBLIC OR BEING USED FOR ANY PURPOSE;
- (7) LOSS OF REGISTERED DATA CAUSED BY ANY FAILURE (INCLUDING INITIALIZATION OF THE PRODUCT DUE TO FORGOTTEN AUTHENTICATION INFORMATION SUCH AS A USER NAME AND PASSWORD).

About notations

The following notations are used when describing the functions limited for specified models. The functions without the notations are supported by all models.



The functions with this notation are available when using the WV-S2536LTN series.



The functions with this notation are available when using the WV-S2536LN series.



The functions with this notation are available when using the WV-S2536L series.



The functions with this notation are available when using the model with the clear dome cover.



The functions with this notation are available when using the model with the smoke dome cover.

System requirements for a PC

CPU:	Intel® Core™ Processor family - Intel® Core™ i5-6500 or faster - Intel® Core™ i7-6700 or faster recommended
Memory:	4 GB (2 GB x 2, Dual Channel) or more recommended.
Network interface:	10BASE-T/100BASE-TX 1 port
Audio interface:	Sound card (when using the audio function)
Monitor:	Image capture size: 1024 x 768 pixels or more Color: 24-bit True color or better
OS:	Microsoft Windows 11 Microsoft Windows 10
Web browser:	Microsoft Edge Firefox Google Chrome™
Others:	Adobe® Reader® or Acrobat Reader® (It is necessary to view the PDF file.)

IMPORTANT:

- For information on the operation verification of web browsers, refer to our support website <Control No.: C0132>.
 - When using a PC that does not meet the above requirements, displaying of images may become slower or the web browser may become inoperable.
 - Audio may not be heard if a sound card is not installed on a PC. Audio may be interrupted depending on the network environment.
-

Network security

As you will use this unit connected to a network, your attention is called to the following security risks.

- ① Leakage or theft of information through this unit
- ② Use of this unit for illegal operations by persons with malicious intent
- ③ Interference with or stoppage of this unit by persons with malicious intent

It is your responsibility to take precautions such as those described below to protect yourself against the above network security risks.

- Use this unit in a network secured by a firewall, etc.
- If this unit is connected to a network that includes PCs, make sure that the system is not infected by computer viruses or other malicious entities (using a regularly updated anti-virus program, anti-spyware program, etc.).
- To prevent unauthorized access, use user-authentication, set user names and passwords, and limit which users can log in.
- Apply measures such as user authentication to protect your network against leakage or theft of information, including image data, authentication information (user names and passwords), alarm mail information and DDNS server information.
- After the unit is accessed by the administrator, make sure to close the browser.
- Change the administrator password periodically. Additionally, save user authentication information (user names and passwords) in such a way that it is kept out of the hands of third parties.
- Do not install the camera in locations where the camera or the cables can be destroyed or damaged by persons with malicious intent.

Precautions for use

When the product is accessible from the Internet

To prevent unauthorized access, note the following.

- Leave user authentication turned on.
- Periodically change passwords that are used to access the product.

Refer to the Operating Instructions for information about how to change passwords.

To keep on using with stable performance

Do not use this product in hot and humid conditions for a long time. Failure to observe this causes component degradation resulting in life shortening of this product. Do not expose this product to direct heat sources such as a heater.

Usage such as switching the power ON/OFF frequently could lead to failure of the camera.

Handle this product with care.

Do not drop this product, nor apply shock or vibration to the product. Failure to observe this may cause trouble.

Do not subject dome cover to strong impact.

Doing so may cause damage or immersion.

Do not directly touch the lens and dome cover with your bare hands.

A dirty dome cover or lens causes deterioration of picture quality.

When an error is detected, this product will restart automatically.

This product will be inoperable for around 2 minutes after the restart just as when the power is turned on.

About the automatic status detection function

When this product malfunctions due to exogenous noise, etc. for 30 seconds or more, the product will automatically restart and will return to normal state. When the product is restart, initialization will be carried out as when the power of the product is turned on. When the product repeatedly resets, exogenous noise level around the product may be high and that may cause malfunction. Contact your dealer for instructions.

Periodically images on the screen appear to be distorted

When the camera is installed in a location where it is subject to small vibrations (for example, when it is installed near devices that vibrate), images may appear distorted and stretched lengthways. This phenomenon is a characteristic of image pickup devices that use CMOS sensors and is caused by the relationship between the periodic movements of the camera and the timing that the image sensor reads images. This is not a problem with the camera. To reduce the possibility of this phenomenon occurring, install the camera in a secure location.

About the ventilation opening

- Because humidity is retained internally in the camera, the camera has a ventilation opening that contains moisture absorption gel.
- Depending on conditions such as temperature, humidity or the climate, condensation may form and it may take time to dehumidify.
- The ventilation opening is on the bottom surface of the camera. Do not caulk (fill the clearance between the camera and the ceiling or wall with sealants or other materials) as internal humidity is discharged through this ventilation opening.

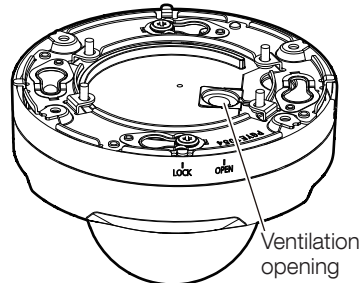

What to do if "WARMING UP-PLEASE WAIT" appears on the display.

This message indicates that the temperature inside the camera has become extremely low. The camera will be automatically restarted when the inside the camera is warmed up by the built-in heater. Please wait for a while.

We shall not be liable for content compensation, losses of recorded or edited content and any direct or indirect consequent damages caused by failure to record or edit due to faults with this unit or the microSD memory card. In addition, the same provisions apply after unit is repaired.

About the CMOS image sensor

- When continuously shooting a bright light source such as a spotlight, the color filter of the CMOS image sensor may become deteriorated and this may cause discoloration. Even when changing the fixed shooting direction after continuously shooting a spotlight for a certain period, the discoloration may remain.
- When shooting fast-moving subjects or objects crossing the shooting area may look to be bending askew.

Cleaning this product body

Be sure to turn off the power before cleaning. Failure to observe this may cause injury. Do not use benzine, thinner, alcohol, or any other types of solvents or detergents. Otherwise, it may cause discoloration. When using a chemical cloth for cleaning, read the caution provided with the chemical cloth product.

- Do not loosen or remove screws unless instructed to do so in the product documentation.

Cleaning the lens

Use a lens cleaning paper (used to clean camera lenses or lenses of spectacles). When using solvent, use an alcohol solvent and do not use a glass cleaner or a thinner.

S2536L

S2536LN

Cleaning of the dome cover

- When cleaning the dome cover, hose or spray fresh water that is not containing lubricant agent or silicon substances and wash away adherents such as grain of sand. If dirt is hard to remove, use a sponge soaked into the fresh water mentioned above and wipe off.
- Do not wipe the dome cover with a dry cloth. (Using dry cloth may spread oil constituent adhered to the surface, and it may result in damaging the ClearSight coating.)

- If dirt cannot be wiped off with a damp cloth, use a neutral detergent for kitchen utensils, and sufficiently rinse off the detergent. When using a detergent containing wax components such as detergent for washing cars, a detergent with polishing material such as a compound, etc., and a non-neutral (weakly acidic or weakly alkaline) detergent, it can decrease the hydrophilic property and peel off the surface coating.
- Do not use organic solvent such as benzene and thinner.
- Before using a spray, abandon a few sprays to eliminate impurities.
- The mark of light-shielding parts left inside the dome cover or dirt on the dome cover may influence the reflection of infrared rays. Therefore, likewise remove those marks and dirt using cleaning paper.
- Improper cleaning of the dome cover may cause the ClearSight coating to become less effective. In this case, in order to have effective ClearSight coating, a new dome cover must be purchased to replace the existing dome cover. Consult with your dealer or construction contractor.

S2536L

Cleaning of the dome cover

Use lens cleaning paper (used to clean camera or spectacles lenses) to remove any dirt on the dome cover. (If dust or the like is adhered at this time, the dome cover may get scratched. We recommend rinsing for stubborn stains.) The mark of light-shielding parts left inside the dome or dirt on the dome cover may influence the reflection of infrared rays. Therefore, likewise remove those marks and dirt using cleaning paper.

About the ClearSight coating

Due to effectiveness of the ClearSight coating, drops are likely to be accumulated right under the camera and it may cause a partial distortion of the video.

AVC Patent Portfolio License

THIS PRODUCT IS LICENSED UNDER THE AVC PATENT PORTFOLIO LICENSE FOR THE PERSONAL USE OF A CONSUMER OR OTHER USES IN WHICH IT DOES NOT RECEIVE REMUNERATION TO (i) ENCODE VIDEO IN COMPLIANCE WITH THE AVC STANDARD ("AVC VIDEO") AND/OR (ii) DECODE AVC VIDEO THAT WAS ENCODED BY A CONSUMER ENGAGED IN A PERSONAL ACTIVITY AND/OR WAS OBTAINED FROM A VIDEO PROVIDER LICENSED TO PROVIDE AVC VIDEO. NO LICENSE IS GRANTED OR SHALL BE IMPLIED FOR ANY OTHER USE. ADDITIONAL INFORMATION MAY BE OBTAINED FROM MPEG LA, L.L.C.
SEE [HTTP://WWW.MPEGLA.COM](http://www.mpegla.com)

Product disposal/transfer

Data saved on this product or a storage device used with this product may lead to personal information leakage. When it is necessary to dispose or give this product to someone, even when for repair, make sure that there is no data on this product.

When abandoning the memory media, it is recommended to destroy it physically after deleting data by PC.

Effects on images and image quality

Under the following conditions, image quality may deteriorate or images may become difficult to see.

- When there are raindrops on the dome cover due to wind during rainfall.
- When there is snow on the dome cover due to wind during snowfall. (varies depending on the amount and quality of snowfall).
- When the dome cover is dirty due to dust in the air or vehicle exhaust.

Router

When connecting this product to the Internet, use a broadband router with the port forwarding function (NAT, IP masquerade).

Refer to the Operating Instructions for further information about the port forwarding function.

Time & date setting

It is necessary to set the time & date before putting this product into operation. Refer to the Operating Instructions for descriptions of how to perform the settings.

Parts and functions

The following are descriptions when using the model WV-S2536LN.

■ Cables

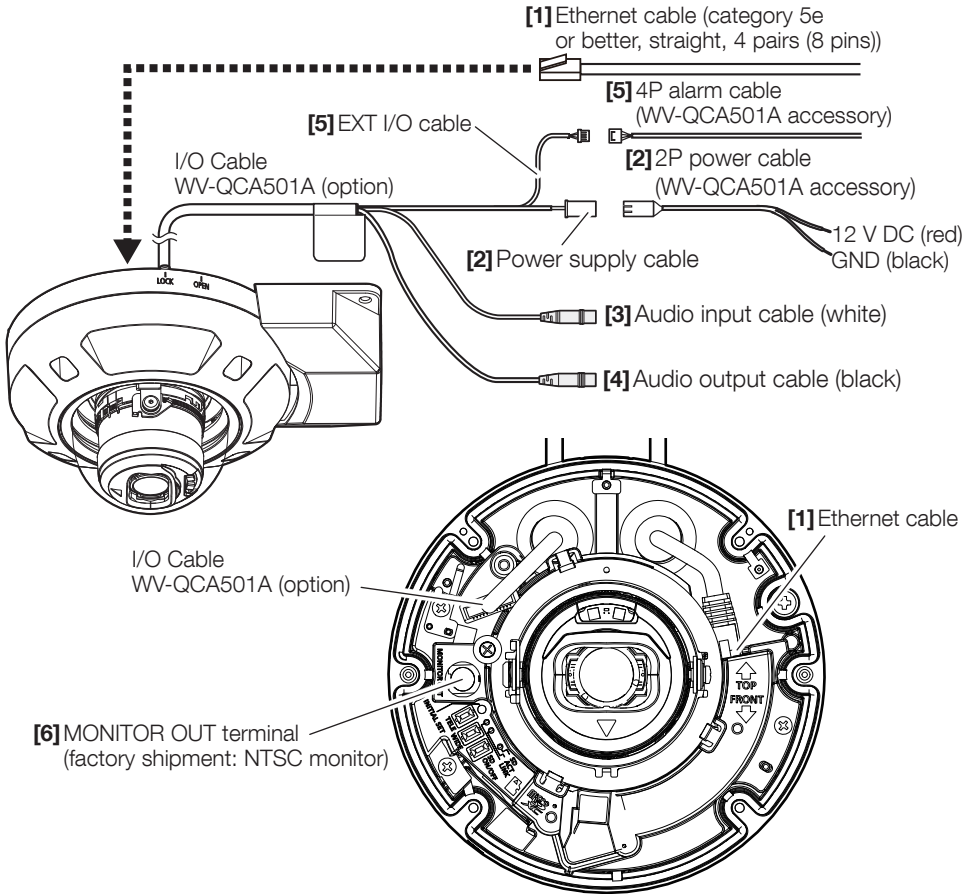

[1] Ethernet cable

Connect an Ethernet cable (category 5e or better, straight, 4 pairs (8 pins)) to the camera.

IMPORTANT:

- Use all 4 pairs (8 pins) of the Ethernet cable.
- The maximum cable length is 100 m {328 feet}.
- Make sure that the PoE device in use is compliant with IEEE802.3af standard.
- When connecting both the 12 V DC power supply and the PoE device for power supply, 12 V DC will be used for power supply.
- When the Ethernet cable is disconnected once, reconnect the cable after around 2 seconds. When the cable is quickly reconnected, the power may not be supplied from the PoE device.

[2] Power supply cable / 2P power cable (WV-QCA501A accessory)

Connect the output cable of the DC power supply to the 2P power cable.

IMPORTANT:

- Be sure to use the 2P power cable provided with WV-QCA501A.
 - Be sure to fully insert the 2P power cable into the power supply cable. Otherwise, it may damage the camera or cause malfunction.
 - When installing the camera, make sure that excessive force is not applied to the power cable.
 - Be sure to use an AC adaptor compliant with the Specifications (written in the indication label on the bottom side of this unit) regarding power source and power consumption.
-

[3] Audio input cable (white)

Connect a microphone or the line out of an external device using a stereo mini plug (ø3.5 mm).

<For microphone input>

- Recommended microphone (locally procured): Plug-in power type
(Sensitivity of microphone: $-48 \text{ dB} \pm 3 \text{ dB}$ (0 dB=1 V/Pa, 1 kHz))
- Input impedance: Approx. 2 k Ω (unbalanced)
- Supply voltage: 2.5 V ± 0.5 V
- Recommended cable length: Less than 1 m {3.28 feet}

<For line input>

- Input level for the line input: Approx. -10 dBV
- Recommended cable length: Less than 10 m {32.8 feet}

[4] Audio output cable (black)

Connect an external speaker* using a stereo mini plug (ø3.5 mm). (Audio output is monaural.)

- Output impedance: Approx. 600 Ω (unbalanced)
- Recommended cable length: Less than 10 m {32.8 feet}
- Output level: -20 dBV *Use a powered speaker.

IMPORTANT:

- Connect/disconnect the audio cables and turn on the power of the camera after turning off the power of the audio output devices. Otherwise, loud noise may be heard from the speaker.
- Make sure that the stereo mini plug is connected to this cable. When a monaural mini plug is connected, audio may not be heard.

When connecting a monaural speaker with amplifier, use a locally procured conversion cable (mono-stereo).

[5] EXT I/O cable / 4P alarm cable (WV-QCA501A accessory)

Note:

- Off, input, and output of the ALARM IN2 and 3 can be switched by configuring the setting. Refer to the Operating Instructions for further information about the ALARM IN2 and 3 settings (“Off”, “Alarm input”, “Alarm output” or “AUX output”).
-

<Ratings>

- Alarm input1 / Black & white input / Auto time adjustment input, Alarm input2, Alarm input3
Input specification: No-voltage make contact input (4 V - 5 V DC, internally pulled up)
OFF: Open or 4 V - 5 V DC
ON: Make contact with GND (required drive current: 1 mA or more)
- Alarm output, AUX output
Output specification: Open collector output (maximum applied voltage: 20 V DC)
OPEN: 4 V - 5 V DC by internal pull-up
CLOSE: Output voltage 1 V DC or less (maximum drive current: 50 mA)

4P alarm cable

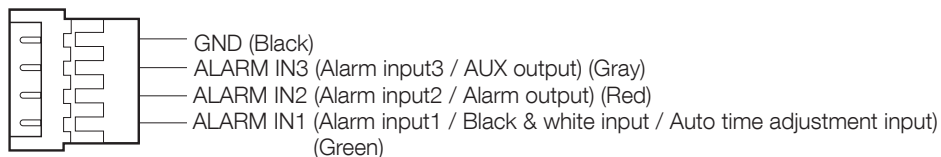

IMPORTANT:

- Install external devices so that they do not exceed the rating of the network camera.
 - When using the ALARM IN2 and/or 3 as the output terminals, ensure they do not cause signal collision with external signals.
-

[6] MONITOR OUT terminal (factory shipment: NTSC monitor)

Used to connect a monitor used for adjustments during installation or when performing service.

IMPORTANT:

- The adjustment monitor is used for checking the adjustment of the angular field of view when installing the camera or when servicing. It is not provided for recording/monitoring use.
 - Depending on the monitor, some characters (date, time, camera title, etc.) may not be displayed on the screen.
 - When [16:9 mode] is selected for “Image capture mode”, the top and bottom of the image on the monitor will be displayed in black.
-

Note:

- The monitor out is set to NTSC in the default settings of the camera. If you want to change the monitor out setting to PAL, refer to the Operating Instructions on our manual website.
-

■ Indicators and buttons

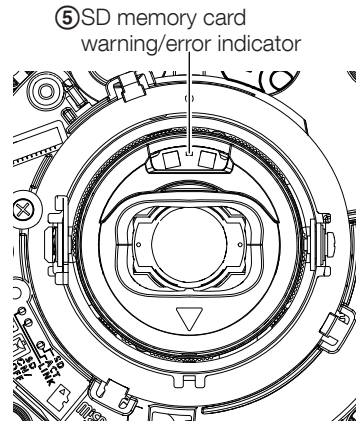
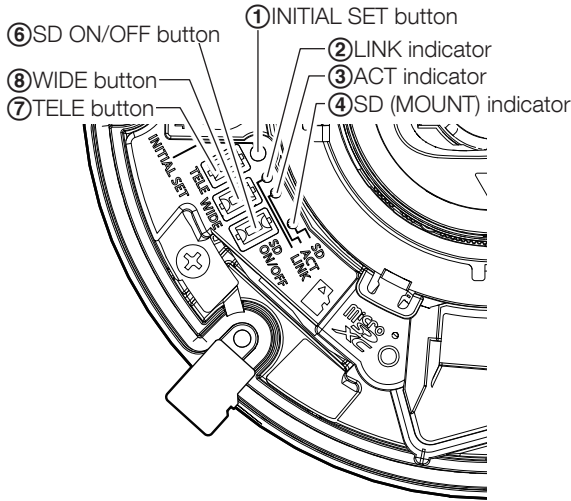

① INITIAL SET button (Initializing / NTSC ⇔ PAL switch button)

Follow the steps below to initialize the network camera.

(1) Turn off the power of the camera.

When using a PoE hub, disconnect the Ethernet cable from the camera. When using an external power supply, disconnect the 2P power cable (WV-QCA501A accessory) from the power supply cable (12V DC).

(2) Turn on the power of the camera while pressing the INITIAL SET button, and make sure to release the button after approximately 15 seconds. In about 2 minutes later, the camera will start up and the settings including the network settings will be initialized. Retry if the camera does not start up normally.

IMPORTANT:

- When the camera is initialized, the settings including the network settings will be initialized. Before initializing the settings, it is recommended to write down the settings in advance.
 - Do not turn off the power of the camera during the process of initialization. Otherwise, it may fail to initialize and may cause malfunction.
-
- When the INITIAL SET button is pressed (less than 1 second) to switch the output signal of the MONITOR OUT terminal, the MONITOR OUT terminal can be switched for the NTSC monitor ⇔ PAL monitor.

② LINK indicator

- When the camera is able to communicate with the connected device
Lights orange

③ ACT indicator

- When data is being sent via the network camera
Blinks green (accessing)

④ SD (MOUNT) indicator

- When a microSD memory card is inserted and could be recognized Lights off → Blinks green → Lights off
- When data can be saved after the microSD memory card is inserted and the SD ON/OFF button is pressed (less than 1 second) Lights off → Lights green
- When data can be saved to the microSD memory card Lights green
- When the microSD memory card is removed after holding down the SD ON/OFF button Lights green → Blinks green → Lights off (recording)
Lights green → Lights off (waiting for recording)
Lights off
- When data cannot be saved to the microSD memory card because an abnormality was detected or the microSD memory card is configured not to be used Lights off

Note:

- Lighting/blinking LED can be turned off with the software settings at any time. (The initial state is lighting or blinking.) Set the LED to be solid off if necessary, depending on the installation conditions. (☞ Operating instructions on our manual website)
-

⑤ SD memory card warning/error indicator

- When a warning status is detected Lights red
*SD memory card warning detection conditions: After the total use time has exceeded 6 years and the number of overwrite times has exceeded 2000.
- When an error status is detected Blinks red
*SD memory card error detection conditions: Write error, read error, etc.

Note:

- The default is off. According to the installation environment, set up with software as required. (☞ Operating instructions on our manual website)
-

⑥ SD ON/OFF button

- (1)When the SD ON/OFF button is pressed (less than 1 second), the SD (MOUNT) indicator lights up in green and data can be saved to the microSD memory card.
- (2)When the SD ON/OFF button is held down (about 2 seconds), the SD (MOUNT) indicator lights off and the microSD memory card can be removed.

⑦ TELE button

Click the TELE button to adjust the zoom ratio to the “Tele” side.

⑧ WIDE button

Click the WIDE button to adjust the zoom ratio to the “Wide” side.

Insert / remove a microSD memory card

Note:

- Refer to the Operating Instructions on our manual website for further information about the microSD memory card settings.
- Refer to our support website <Control No.: C0107> for latest information about the compatible microSD memory cards.

■ Insert a microSD memory card

- ① Remove the enclosure from the camera. (Refer to installation procedure leaflet)
- ② Insert the microSD memory card until it makes a clicking sound.
- ③ Take your fingers off the microSD memory card and check that its back end does not protrude over the side part of the camera.
- ④ After the microSD memory card has been inserted, press the SD ON/OFF button, and make sure the SD (MOUNT) indicator is continually lit.
If you do not press the SD ON/OFF button after inserting the microSD memory card, the SD (MOUNT) indicator is automatically lit approximately 5 minutes later.

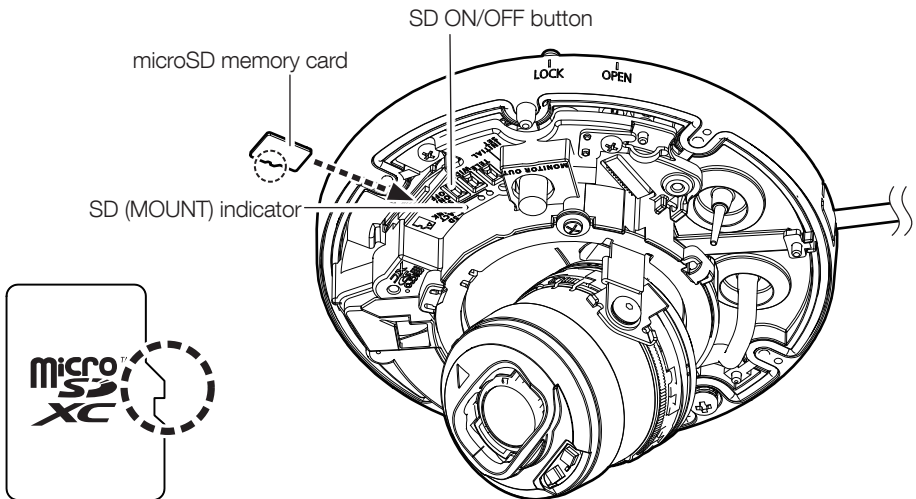

- ⑤ Attach the enclosure to the camera.

■ Remove a microSD memory card

When removing a microSD memory card, reverse the procedure.

- To remove the microSD memory card, hold down the SD ON/OFF button for about 2 seconds. When the flashing SD (MOUNT) indicator goes out, you can remove the microSD memory card.

IMPORTANT:

- Before turning off the camera power switch, make sure that the SD (MOUNT) indicator is turned off. If you turn off the camera power switch while the SD (MOUNT) indicator is lit or flashing, the recorded data may be corrupted or damaged.

Note:

- When using a microSD memory card, format it using this product. Recorded data on the microSD memory card will be deleted when formatted. If an unformatted microSD memory card or a microSD memory card formatted with other devices is used, this product may not work properly or performance deterioration may be caused. Refer to the Operating Instructions on our manual website for how to format a microSD memory card.
- When some microSD memory cards are used with this product, the product may not work properly or performance deterioration may be caused. Use the compatible microSD memory cards.

(To our support website <Control No.: C0107>)

Troubleshooting

Before asking for repairs, check the symptoms with the following table.



Contact your dealer if a problem cannot be solved even after checking and trying the solution in the table or a problem is not described below.

Symptom	Cause/solution	Reference pages
Power is not turned on.	When using a PoE device for power supply <ul style="list-style-type: none"> Are the PoE device (IEEE802.3af compliant) and the RJ45 Network connector connected using an Ethernet cable? Check whether the connection is appropriately established. Depending on the PoE device, the power supply will stop when the demanded power exceeds its total power limit for all PoE ports. Refer to the operating instructions of the PoE device in use. 	Installation Guide
	When using DC power supply <ul style="list-style-type: none"> Is the 2P power cable (WV-QCA501A accessory) firmly inserted into the power supply cable of the camera? Confirm the power plug is firmly connected. Is the AC adaptor in use compliant with the Specifications? Check the Specifications regarding AC adaptor. 	
The LINK indicator does not light in orange even when the Ethernet cable is connected to the camera.	<ul style="list-style-type: none"> Is the Ethernet cable connected appropriately? Connect the Ethernet cable appropriately. Is the hub or router connected to the camera operating appropriately? Check if the hub or router in use is operating appropriately. Is the Ethernet cable connected to the camera broken? Replace the cable with another one. 	12
The SD (MOUNT) indicator does not light even when a microSD memory card is installed.	This indicator lights up green when the microSD memory card is recognized correctly and ready for use. <ul style="list-style-type: none"> Has the inserted microSD memory card been formatted on a PC? Use a microSD memory card formatted on the camera. Or install the software to format the microSD memory card on the PC. Refer to our website <Control No.: C0105> for further information about the supported software. 	12, 13
SD memory card warning/error indicator lights red.	<ul style="list-style-type: none"> The read/write error on the microSD card has occurred. Is the inserted microSD memory card faulty? Replace the card with a normal one. 	12, 13

Symptom	Cause/solution	Reference pages
Audio input contains noise.	<ul style="list-style-type: none"> • Check the following. <ul style="list-style-type: none"> • Grounding of the camera, a switching hub or peripheral devices are not done. • The camera is used near an electrical power line. • The camera is used near a device which produces strong magnetic field or radio waves (such as near a TV/radio antenna, a motor of an air conditioning system, a transformer, etc.) <p>When audio input still contains noise even after checking the above possibilities, use a powered microphone or connect audio output with low output impedance.</p>	Installation Guide
Auto focus (AF) can not be automatically adjusted.	<ul style="list-style-type: none"> • In the following locations or with the following subjects, the focus may not be able to be automatically adjusted. In this case, manually adjust the focus from the software screen. <ul style="list-style-type: none"> • When the subject moves a lot • When there are large changes to the lighting intensity • When the light level is low • When the subject or location is extremely bright or reflective • When viewing through windows • When the dome cover is in a locations where it can easily become dirty • Locations where there is not much contrast such as a white wall • When there is harsh flickering 	Operating Instructions
After installing the enclosure, it may be out of focus.	<ul style="list-style-type: none"> • Depending on the installation environment, the optimum focus position may change after the enclosure is installed. In that case, carry out the auto focus function from the setup menu. 	Operating Instructions
When the enclosure is removed and the camera is checked on the screen, it appears that there are shadows in the four corners.	<ul style="list-style-type: none"> • Depending on the position of the shading rubber on the lens, the shading rubber may appear in the viewing screen. When the enclosure is attached to the camera, the shading rubber returns to the correct position. This is not a fault with the camera. 	-
When shooting monochrome images using the IR LED Light, a white dots or line may appear on the screen.	<ul style="list-style-type: none"> • When adjusting the camera's angular field of view, at around TILT: 70°–85° and YAW: 50°–100°, the IR LED Light will be reflected off the camera body and projected onto the image. To avoid this reflection, re-adjust it to TILT: 70° or less and YAW: 50° or less. 	Support website <Control No.: C0109>
Double image phenomenon may appear on the screen.	<ul style="list-style-type: none"> • A fixed dome camera may display a double image depending on the vertical (TILT) angle, due to the curvature of its dome cover. This phenomenon occurs when the camera direction is nearly horizontal. Occurrence condition: when the vertical (TILT) angle is approx. 70 degrees or higher. Countermeasure: Adjust the vertical (TILT) angle to lower than 70 degrees. 	Support website <Control No.: C0128>

Detail specifications

• Basic

Power source *1, *6:	DC 12 V PoE (IEEE802.3af compliant)
Power consumption *1:	S2536LT DC 12 V: 860 mA/ Approx. 10.3 W PoE DC 48 V: 210 mA/ Approx. 10.1 W (Class 0 device) S2536LN S2536L DC 12 V: 730 mA/ Approx. 8.8 W PoE DC 48 V: 190 mA/ Approx. 9.1 W (Class 0 device)
Operating environment Ambient operating temperature:	-40 °C to +60 °C *2 {-40 °F to +140 °F} (Power On range: -30 °C to +60 °C {-22 °F to +140 °F})
Ambient operating humidity:	10 % to 100 % (no condensation)
Storage environment Storage temperature:	-30 °C to +60 °C {-22 °F to +140 °F}
Storage humidity:	10 % to 95 % (no condensation)
Monitor output (for adjustment):	VBS: 1.0 V [p-p]/75 Ω, composite, Pin jack An NTSC or PAL signal can be outputted from camera (either press the INITIAL SET button quickly (within 1 second) or use software to select NTSC or PAL signal).
EXT I/O terminals*6:	ALARM IN1 (Alarm input 1/ Black & white input/ Auto time adjustment input) (x1) ALARM IN2 (Alarm input 2/ ALARM OUT) (x1) ALARM IN3 (Alarm input 3/ AUX OUT) (x1)
Audio input*6: For microphone input:	ø3.5 mm stereo mini jack Recommended applicable microphone: Plug-in power type (Sensitivity of microphone: -48 dB±3 dB (0 dB=1 V/Pa, 1 kHz)) Input impedance: Approx. 2 kΩ (unbalanced) Supply voltage: 2.5 V ±0.5 V
For line input:	Input level: Approx. -10 dBV
Audio output *3, *6:	ø3.5 mm stereo mini jack (Audio output is monaural.) Output impedance: Approx. 600 Ω (unbalanced) Output level: -20 dBV
Waterproof *4:	IP66 (IEC 60529), Type 4X (UL50E) NEMA 4X compliant
Shock resistance:	50 J (IEC 60068-2-75 compliant), IK10 (IEC 62262)
Wind resistance:	Up to 40 m/s {approx. 89 mph}
Dimensions:	ø154 mm × 105 mm (H) {ø6-1/16 inches × 4-1/8 inches (H)} Dome radius 42 mm {1-21/32 inches} (excluding an attachment for the conduit portion)
Mass:	Approx. 1.1 kg {2.43 lbs.} (excluding an attachment for the conduit portion)
Finish:	Main body: Aluminum die cast, i-PRO white Outer fixing screws: Stainless steel (Corrosion-resistant treatment) Dome cover: PC resin,   S2536LT S2536LN (with ClearSight coating)



Others:	Tamper-resistant enclosure ⁵
---------	---

- *1 Refer to our support website <Control No.: C0106> for further information about Power source and Power consumption information.
- *2 When using with the IR LED Light constantly lit, the upper limit of the operating temperature range is +50 °C {+122 °F}.
- *3 The audio output can be switched to the monitor output. Refer to the “Operating Instructions” on our manual website for descriptions of how to switch the output.
- *4 Only when installation work is properly performed according to the Installation Guide and appropriate waterproof treatment is performed.
- *5 Component that has a structure on which the screws that are accessible after installation cannot be screwed or unscrewed using an ordinary screwdriver.
- *6 When using a 12 V DC power supply of this product, EXT I/O terminal, audio input, and audio output, I/O cable (option: WV-QCA501) is required.

• **Camera**

Image sensor:	Approx. 1/2.8 type CMOS image sensor
Effective pixels:	Approx. 2.1 megapixels
Scanning area:	5.57 mm (H) × 3.13 mm (V) {7/32 inches (H) × 1/8 inches (V)}
Scanning system:	Progressive
Minimum illumination:	<p>S2536LT</p> <p>Color: 0.011 lx {0.00103 footcandle} (30IRE, F1.7, Maximum shutter: Off (1/30 s), AGC: 11)* 0.015 lx {0.00139 footcandle} (50IRE, F1.7, Maximum shutter: Off (1/30 s), AGC: 11) 0.001 lx {0.00009 footcandle} (50IRE, F1.7, Maximum shutter: max. 16/30 s, AGC: 11)*</p> <p>BW: 0 lx {0 footcandle} (50IRE, F1.7, Maximum shutter: OFF (1/30 s), AGC: 11, when the IR LED is lit) 0.008 lx {0.00074 footcandle} (50IRE, F1.7, Maximum shutter: Off (1/30 s), AGC: 11) 0.0005 lx {0.00004 footcandle} (50IRE, F1.7, Maximum shutter: max. 16/30 s, AGC: 11)*</p> <p>S2536LN S2536L</p> <p>Color:</p> <p>C 0.007 lx {0.00065 footcandle} (30IRE, F1.3, Maximum shutter: Off (1/30 s), AGC: 11)* 0.009 lx {0.00084 footcandle} (50IRE, F1.3, Maximum shutter: Off (1/30 s), AGC: 11) 0.0006 lx {0.00006 footcandle} (50IRE, F1.3, Maximum shutter: max. 16/30 s, AGC: 11)*</p> <p>C 0.018 lx {0.0019 footcandle} (30IRE, F1.3, Maximum shutter: Off (1/30 s), AGC: 11)* 0.025 lx {0.0024 footcandle} (50IRE, F1.3, Maximum shutter: Off (1/30 s), AGC: 11) 0.0016 lx {0.00015 footcandle} (50IRE, F1.3, Maximum shutter: max. 16/30 s, AGC: 11)*</p> <p>BW: 0 lx {0 footcandle} (50IRE, F1.3, Maximum shutter: OFF (1/30 s), AGC: 11, when the IR LED is lit)</p> <p>C 0.005 lx {0.00046 footcandle} (50IRE, F1.3, Maximum shutter: Off (1/30 s), AGC: 11) 0.0004 lx {0.00004 footcandle} (50IRE, F1.3, Maximum shutter: max. 16/30 s, AGC: 11)*</p>

	 0.017 lx {0.0016 footcandle} (50IRE, F1.3, Maximum shutter: Off (1/30 s), AGC: 11) 0.0011 lx {0.0001 footcandle} (50IRE, F1.3, Maximum shutter: max. 16/30 s, AGC: 11)* * Converted value
Intelligent Auto:	On/ Off
Super Dynamic *1:	On/ Off The level can be set in the range of 0 to 31.
Dynamic range:	Max. 144 dB (Super Dynamic: On, Level: 31)
Maximum gain:	The level can be set in the range of 0 to 11.
Adaptive black stretch:	The level can be set in the range of 0 to 255.
Back light compensation (BLC) / High light compensation (HLC):	BLC/ HLC/ Off The level can be set in the range of 0 to 31. (only when Super Dynamic/ Intelligent Auto: Off)
Fog compensation:	On/ Off The level can be set in the range of 0 to 8. (only when Intelligent Auto / Auto contrast adjust: Off)
Light control mode setting:	Outdoor scene/ Indoor scene (50 Hz)/ Indoor scene (60 Hz)/ Fix shutter
Shutter speed:	[60 fps mode] 1/60 Fix, 1/100 Fix, 1/120 Fix, 1/250 Fix, 1/500 Fix, 1/1000 Fix, 1/2000 Fix, 1/4000 Fix, 1/10000 Fix [30 fps/ 15 fps mode] 1/30 Fix, 3/120 Fix, 2/100 Fix, 2/120 Fix, 1/100 Fix, 1/120 Fix, 1/250 Fix, 1/500 Fix, 1/1000 Fix, 1/2000 Fix, 1/4000 Fix, 1/10000 Fix [50 fps mode] 1/50 Fix, 1/100 Fix, 1/250 Fix, 1/500 Fix, 1/1000 Fix, 1/2000 Fix, 1/4000 Fix, 1/10000 Fix [25 fps/ 12.5 fps mode] 1/25 Fix, 3/100 Fix, 2/100 Fix, 1/100 Fix, 1/250 Fix, 1/500 Fix, 1/1000 Fix, 1/2000 Fix, 1/4000 Fix, 1/10000 Fix
Maximum shutter:	[60 fps mode] Max. 1/4000 s, Max. 1/2000 s, Max. 1/1000 s, Max. 1/500 s, Max. 1/250 s, Max. 1/120 s, Max. 1/100 s, Max. 2/120 s, Max. 1/30 s, Max. 2/30 s, Max. 4/30 s, Max. 6/30 s, Max. 10/30 s, Max. 16/30 s [30 fps/ 15 fps mode] Max. 1/4000 s, Max. 1/2000 s, Max. 1/1000 s, Max. 1/500 s, Max. 1/250 s, Max. 1/120 s, Max. 1/100 s, Max. 2/120 s, Max. 2/100 s, Max. 3/120 s, Max. 1/30 s, Max. 2/30 s, Max. 4/30 s, Max. 6/30 s, Max. 10/30 s, Max. 16/30 s [50 fps mode] Max. 1/4000 s, Max. 1/2000 s, Max. 1/1000 s, Max. 1/500 s, Max. 1/250 s, Max. 1/100 s, Max. 2/100 s, Max. 1/25 s, Max. 2/25 s, Max. 4/25 s, Max. 6/25 s, Max. 10/25 s, Max. 16/25 s [25 fps/ 12.5 fps mode] Max. 1/4000 s, Max. 1/2000 s, Max. 1/1000 s, Max. 1/500 s, Max. 1/250 s, Max. 1/100 s, Max. 2/100 s, Max. 3/100 s, Max. 1/25 s, Max. 2/25 s, Max. 4/25 s, Max. 6/25 s, Max. 10/25 s, Max. 16/25 s
Color/BW:	Off/ On(IR Light Off)/ On(IR Light On)/ Auto1(IR Light Off)/ Auto2(IR Light On)/ Auto3(SCC)

IR LED Light:	High/ Middle/ Low/ Off  Maximum irradiation distance: 70 m {Approx. 230 ft} (30IRE)* 50 m {Approx. 164 ft} (50IRE)  Maximum irradiation distance: 50 m {Approx. 164 ft} (30IRE)* 35 m {Approx. 116 ft} (50IRE) * Converted value
White balance:	ATW1/ ATW2/ AWC
Digital noise reduction:	The level can be set in the range of 0 to 255.
Privacy zone:	On/ Off Up to 8 zones available
VIQS:	On/ Off Up to 8 zones available
Camera title on screen:	On/ Off Up to 40 characters, Up to 2 lines (alphanumeric characters, marks)
Video Motion Detection (VMD):	On/ Off 4 areas available
Scene Change Detection (SCD):	On/ Off 1 area available
Audio Detection:	On/ Off
AI Sound classification:	Selectable from Gunshot, Yell, Vehicle horn, Glass break
Image rotation *2 *3 *4:	0° (Off)/ 90°/ 180° (Upside-down)/ 270°









*1 When 60 fps or 50 fps is selected, the Super Dynamic function is automatically set to off.

*2 When the 320x180 resolution is used, the “90°” and “270°” settings are not available.

*3 The analog output from the MONITOR OUT terminal will not rotate even when “90 °” or “270 °” is selected for [Image rotation].

*4 When [16:9 mode(30 fps mode)] or [16:9 mode(25 fps mode)] is used, the “90°” and “270°” settings are available.

• Lens

Zoom ratio:	 Optical zoom 2.3x (Motorized zoom / Motorized focus) Extra optical zoom max 6.9x (2.3x – 6.9x when resolution is 640x360)   Optical zoom 3.1x (Motorized zoom / Motorized focus) Extra optical zoom max 9.3x (3.1x – 9.3x when resolution is 640x360)
Focal length:	 9 mm – 21 mm {11/32 inches – 13/16 inches}   2.9 mm – 9 mm {1/8 inches – 11/32 inches}
Maximum aperture ratio:	 1:1.7 (WIDE) – 1:3.0 (TELE)   1:1.3 (WIDE) – 1:2.5 (TELE)

Focus range:	<p>S2536LT</p> <p>2 m {78-3/4 inches} – ∞</p> <p>S2536LN S2536L</p> <p>0.3 m {11-13/16 inches} – ∞</p>
Aperture range:	<p>S2536LT</p> <p>F1.7 – T405</p> <p>S2536LN S2536L</p> <p>F1.3 – Close</p>
Angular field of view:	<p>S2536LT</p> <p>[16:9 mode] Horizontal: 15° (TELE) – 36° (WIDE) Vertical: 9° (TELE) – 20° (WIDE)</p> <p>[4:3 mode] Horizontal: 11° (TELE) – 27° (WIDE) Vertical: 9° (TELE) – 20° (WIDE)</p> <p>S2536LN S2536L</p> <p>[16:9 mode] Horizontal: 36° (TELE) – 113° (WIDE) Vertical: 20° (TELE) – 60° (WIDE)</p> <p>[4:3 mode] Horizontal: 26° (TELE) – 82° (WIDE) Vertical: 20° (TELE) – 60° (WIDE)</p>
DORI *1:	<p>S2536LT</p> <p>Detect (25 ppm / 8 ppf) 291.7 m {956.9 ft} (TELE) 118.2 m {387.7 ft} (WIDE) Observe (62.5 ppm / 19 ppf) 116.7 m {382.8 ft} (TELE) 47.3 m {155.1 ft} (WIDE) Recognize (125 ppm / 38 ppf) 58.3 m {191.4 ft} (TELE) 23.6 m {77.5 ft} (WIDE) Identify (250 ppm / 76 ppf) 29.2 m {95.7 ft} (TELE) 11.8 m {38.8 ft} (WIDE)</p> <p>S2536LN S2536L</p> <p>Detect (25 ppm / 8 ppf) 118.2 m {387.7 ft} (TELE) 25.4 m {83.4 ft} (WIDE) Observe (62.5 ppm / 19 ppf) 47.3 m {155.1 ft} (TELE) 10.2 m {33.4 ft} (WIDE) Recognize (125 ppm / 38 ppf) 23.6 m {77.5 ft} (TELE) 5.1 m {16.7 ft} (WIDE) Identify (250 ppm / 76 ppf) 11.8 m {38.8 ft} (TELE) 2.5 m {8.3 ft} (WIDE)</p>
Adjusting angle:	<p>Horizontal (PAN) angle: -194° to +166° Vertical (TILT) angle: -30° to +85° Azimuth (YAW) angle: ±100°</p>

*1 Maximum distance at which a camera's tele and wide lens can meet DORI specifications. This value does not indicate the performance of the camera. Calculations made with the camera installed horizontally at resolution of maximum resolution.

• Network

Network:	10BASE-T/100BASE-TX, RJ45 connector
----------	-------------------------------------

<p>Resolution: H.265/ H.264 *1 JPEG (MJPEG)</p>	<p>[16:9 mode(60 fps mode)][16:9 mode(30 fps mode)] [16:9 mode(50 fps mode)][16:9 mode(25 fps mode)] 1920×1080/ 1280×720/ 640×360/ 320×180 [4:3 mode(30 fps mode)] [4:3 mode(25 fps mode)] 1280×960/ VGA/ QVGA [4:3 mode(15 fps mode)] [4:3 mode(12.5 fps mode)] 2048×1536 *2/ 1280×960/ VGA/ QVG</p>
<p>Image compression method *3: H.265/ H.264 *1</p>	<p>Transmission priority: Constant bit rate/ VBR/ Frame rate/ Best effort</p> <p>Frame rate:</p> <p>[60 fps mode] 1 fps/ 3 fps/ 5 fps*/ 7.5 fps*/ 10 fps*/ 12 fps*/ 15 fps*/ 20 fps*/ 30 fps*/ 60 fps*</p> <p>[30 fps mode] 1 fps/ 3 fps/ 5 fps*/ 7.5 fps*/ 10 fps*/ 12 fps*/ 15 fps*/ 20 fps*/ 30 fps*</p> <p>[15 fps mode] 1 fps/ 3 fps/ 5 fps*/ 7.5 fps*/ 10 fps*/ 12 fps*/ 15 fps*</p> <p>[50 fps mode] 1 fps/ 3.1 fps/ 4.2 fps*/ 6.25 fps*/ 8.3 fps*/ 12.5 fps*/ 20 fps*/ 25 fps*/ 50 fps*</p> <p>[25 fps mode] 1 fps/ 3.1 fps/ 4.2 fps*/ 6.25 fps*/ 8.3 fps*/ 12.5 fps*/ 20 fps*/ 25 fps*</p> <p>[12.5 fps mode] 1 fps/ 3.1 fps/ 4.2 fps*/ 6.25 fps*/ 8.3 fps*/ 12.5 fps*</p> <p>(The frame rate is limited to “bit rate”. When a value with an asterisk (*) is selected, the actual frame rate may be lower than the value selected.)</p> <p>Bit rate per client: 64 kbps/ 128 kbps*/ 256 kbps*/ 384 kbps*/ 512 kbps*/ 768 kbps*/ 1024 kbps*/ 1536 kbps*/ 2048 kbps*/ 3072 kbps*/ 4096 kbps*/ 6144 kbps*/ 8192 kbps*/ 10240 kbps*/ 12288 kbps*/ 14336 kbps*/ 16384 kbps*/ 20480 kbps*/ 24576 kbps*/ --FREE ENTRY--</p> <p>*The available range of the bit rate varies depending on the setting selected for “image capture size”.</p> <p>Image quality:</p> <ul style="list-style-type: none"> • For “Constant bit rate”, “Frame rate”, and “Best effort”: Low(Motion priority)/ Normal/ Fine(Image quality priority) • “VBR”: 0 Super fine/ 1 Fine/ 2/ 3/ 4/ 5 Normal/ 6/ 7/ 8/ 9 Low <p>Transmission type: Unicast port (AUTO)/ Unicast port (MANUAL)/ Multicast</p>

JPEG (MJPEG)	<p>Image quality: 0 SUPER FINE/ 1 FINE/ 2/ 3/ 4/ 5 NORMAL/ 6/ 7/ 8/ 9 LOW (10 steps: 0-9)</p> <p>Transmission type: Pull (Refresh interval)/ Push (MJPEG)</p> <p>Refresh interval: [60 fps mode] 0.1 fps/ 0.2 fps/ 0.33 fps/ 0.5 fps/ 1 fps/ 2 fps/ 3 fps/ 5 fps/ 6 fps/ 10 fps/ 12 fps/ 15 fps/ 30 fps/ 60 fps [30 fps mode] 0.1 fps/ 0.2 fps/ 0.33 fps/ 0.5 fps/ 1 fps/ 2 fps/ 3 fps/ 5 fps/ 6 fps/ 10 fps/ 12 fps/ 15 fps/ 30 fps [15 fps mode] 0.1 fps/ 0.2 fps/ 0.33 fps/ 0.5 fps/ 1 fps/ 2 fps/ 3 fps/ 5 fps/ 6 fps/ 10 fps/ 12 fps/ 15 fps [50 fps mode] 0.08 fps/ 0.17 fps/ 0.28 fps/ 0.42 fps/ 1 fps/ 2.1 fps/ 3.1 fps/ 4.2 fps/ 5 fps/ 8.3 fps/ 12.5 fps/ 25 fps/ 50 fps [25 fps mode] 0.08 fps/ 0.17 fps/ 0.28 fps/ 0.42 fps/ 1 fps/ 2.1 fps/ 3.1 fps/ 4.2 fps/ 5 fps/ 8.3 fps/ 12.5 fps/ 25 fps [12.5 fps mode] 0.08 fps/ 0.17 fps/ 0.28 fps/ 0.42 fps/ 1 fps/ 2.1 fps/ 3.1 fps/ 4.2 fps/ 5 fps/ 8.3 fps/ 12.5 fps (JPEG frame rates are limited when using JPEG and H.265/H.264 simultaneously.)</p>
Smart coding:	<p>GOP(Group of pictures) control Off/ Low (Variable GOP 1s-8s)/Mid (Variable GOP 4s-16s)/ Advanced (Fixed GOP 60 seconds with 1 second Key frame)/ Frame rate control (Variable GOP 4s-16s with frame rate control) Advanced and Frame rate control are only available with H.265.</p> <p>Smart VIQS On(High)/ On(Low)/ Off</p> <p>Smart P-picture control On/ Off</p>
Audio compression method:	<p>G.726 (ADPCM): 16 kbps/ 32 kbps G.711: 64 kbps AAC-LC*4: 64 kbps/ 96 kbps/ 128 kbps</p>
Bandwidth control:	<p>Unlimited/ 64 kbps/ 128 kbps/ 256 kbps/ 384 kbps/ 512 kbps/ 768 kbps/ 1024 kbps/ 2048 kbps/ 4096 kbps/ 6144 kbps/ 8192 kbps/ 10240 kbps/ 15360 kbps/ 20480 kbps/ 25600 kbps/ 30720 kbps/ 35840 kbps/ 40960 kbps/ 51200 kbps</p>
Protocol:	<p>IPv6: TCP/IP, UDP/IP, HTTP, HTTPS, SSL/TLS, SMTP, DNS, NTP, SNMPv1/v2/v3, DHCPv6, RTP, MLD, ICMP, ARP, IEEE 802.1X, DiffServ, LLDP, FTP, SFTP, MQTT</p> <p>IPv4: TCP/IP, UDP/IP, HTTP, HTTPS, SSL/TLS, RTSP, RTP, RTP/RTCP, SMTP, DHCP, DNS, DDNS, NTP, SNMPv1/v2/v3, UPnP, IGMP, ICMP, ARP, IEEE 802.1X, DiffServ, SRTP, LLDP, FTP, SFTP, MQTT</p>
Security:	<p>User authentication, Host authentication, HTTPS FIPS 140-2 level3 *5</p>
OS:	<p>Microsoft Windows 11 Microsoft Windows 10</p>

Browser *6:	Microsoft Edge Firefox Google Chrome
Maximum concurrent access number:	14* (Number of sessions that can connect to cameras at the same time) * Depends on network conditions
Multi-screen:	Up to 16 camera images can be displayed simultaneously on a multi-screen. (Including the camera itself) *7
microSD memory card *8, *9, *10, *11, *12 :	microSDXC memory card: 64 GB, 128 GB, 256 GB, 512 GB microSDHC memory card: 4 GB, 8 GB, 16 GB, 32 GB microSD memory card: 2 GB
Mobile terminal/ Tablet terminal compatibility:	iPad / iPhone (iOS 8.0 or later), Android™ terminals

*1 H.265/H.264 can be selected for each stream.

*2 Used by super resolution techniques.

*3 Transmission for 4 streams can be individually set.

*4 When recording audio on a microSD memory card, only use AAC-LC (Advanced Audio Coding - Low Complexity).

*5 For the following model only: WV-S2536LTNA, WV-S2536LNA, WV-S2536LGNA, WV-S2536LA, WV-S2536LGA

*6 For information on the operation verification of the supported web browsers, refer to our support website <Control No.: C0132>.

*7 When using MJPEG/JPEG (Refresh interval) only.

*8 Refer to our support website <Control No.: C0107> for latest information about the compatible microSD memory cards.

*9 For possible number of images and duration (an indication) that can be saved on the microSD memory card, refer to our support website below.

Possible number of JPEG images that can be saved: <Control No.: C0306>

Possible duration of stream images (H.265 or H.264) that can be saved: <Control No.: C0307>

*10 Use the microSD memory card with SD Speed Class 6 or higher. Use the microSD memory card that complies with UHS-1(Ultra High Speed-1) in the case of SD Speed Class 10.

*11 Refer to our support website <Control No.:C0117> for the replacement cycle (target) of a microSD memory card.

*12 When repeatedly recording images on a microSD memory card using the auto overwrite function, make sure to use a microSD memory card with high reliability and durability.

i-PRO Co., Ltd.

Tokyo, Japan

<https://www.i-pro.com/>

Authorised Representative in EU:
i-PRO EMEA B.V.
Laarderhoogtweg 25, 1101 EB
Amsterdam, Netherlands

i-PRO EMEA B.V. UK Branch
1010 Cambourne Business Park,
Cambridgeshire CB23 6DP

