

## Overview

- 4 Megapixel IR
- True WDR 120dB
- 2.8mm Lens
- Built-In Mic
- H.265
- Indoor Camera







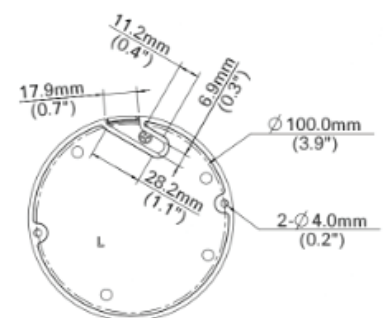
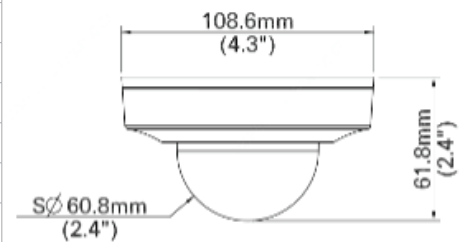









## Technical Specifications

Device	
Image Sensor:	1/3" Progressive Scan CMOS
Min Illumination:	Color: 0.01Lux (F2.0, AGC ON)   0Lux with IR
Shutter Time:	Auto/Manual, 1 ~ 1/100000s
Lens:	2.8mm@F2.0
WDR:	120 dB
Angle of View:	H: 95.8°, V: 55.2°, 124.5°
Angle Adjustment:	Pan: 3° ~ 360°   Tilt: 0° ~ 68°   Rotate: 3° ~ 360°
3-Axis Adjustment:	Yes
Day & Night:	IR-Cut Filter with Auto Switch (ICR)
IR Range:	Up to 30m (98ft) IR range
Compression Standard	
Video Compression:	H.265, H.264, MJPEG
Video Bit Rate:	128 Kbps~16 Mbps
Tri-Stream:	Yes
Analytics:	Intrusion, Human Body Detection, Motion Detection, Tampering Alarm, Audio Detection
Image	
Max. Image Resolution:	2688 x 1520
Frame Rate:	30fps (2688 x 1520)
ROI Codec:	Up to 2 areas
Image Setting:	White Balance, Digital Noise Reduction, Smart IR, Flip, HLC, BLC



## Technical Specifications

Network							
Alarm Channels:	1 Channel In   1 Channel Out						
Protocols:	IPv4, IGMP, ICMP, ARP, TCP, UDP, DHCP, RTP, RTSP, RTCP, DNS, DDNS, NTP, FTP, UPnP, HTTP, HTTPS, SMTP, SSL, QoS						
Interface							
Communication Interface:	10M/100M Base-TX Ethernet						
Local Storage:	Micro SD, up to 256GB						
Audio:	Input: Impedance 35kΩ; Amplitude 2V [p-p] Output: Impedance 600Ω; Amplitude 2V [p-p]						
General							
Safety	UL (IEC60950-1), CE, IEC62368-1						
EMC	FCC (Part15 ClassA), EN55032 ClassB, EN55024						
Operating Conditions:	Temperature: -35°C ~ 60°C (-31°F ~ 140°F), Humidity: ≤95% RH (Non-Condensing)						
Power Consumption:	Max 5.5W						
Power Supply:	DC 12V±25%, PoE (IEEE 802.3af)						
Weather Proof Rating:	–						
Vandal Resistant:	–						
Dimensions:	Φ108.6 x 61.8mm (Ø4.28" x 2.43")						
Weight:	0.22kg (0.49lb)						
Software:	Includes Video Insight VMS License						
Accessories	<table border="0"> <tr> <td style="text-align: center;">M-JB-MINI </td> <td style="text-align: center;">M-WM-JB-MINI </td> <td style="text-align: center;">M-PM </td> </tr> <tr> <td style="text-align: center;">M-Pendant-Ex </td> <td style="text-align: center;">M-Pendant </td> <td></td> </tr> </table>	M-JB-MINI 	M-WM-JB-MINI 	M-PM 	M-Pendant-Ex 	M-Pendant 	
M-JB-MINI 	M-WM-JB-MINI 	M-PM 					
M-Pendant-Ex 	M-Pendant 						

R011322 | Product specifications and availability are subject to change without notice.

© i-PRO Co., Ltd. All Rights Reserved. i-PRO, Viewnetcam.com, Advidia, VideoInsight, CloUDE, and Unified Digital Evidence are registered trademarks or trademarks of i-PRO Co., Ltd. or i-PRO Americas Inc. in various jurisdictions. All other trademarks are the property of their respective owners.