

## Operating Instructions

### Network Camera

---

Model No. WV-S61300 Series  
WV-S65300 Series  
WV-U61300 Series  
WV-U65300 Series  
WV-S65501-Z1  
WV-S61501-Z1

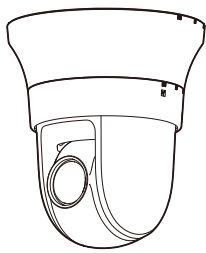

WV-S61302-Z4

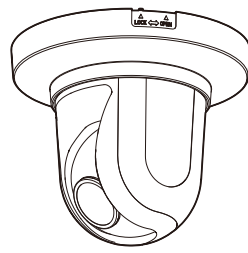

WV-S61301-Z2

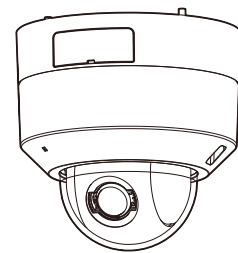

WV-U61300-ZY

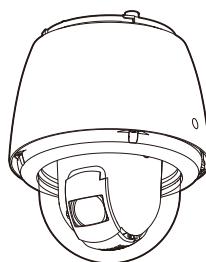

WV-S65340-Z4

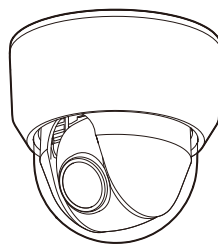

WV-U65302-Z2

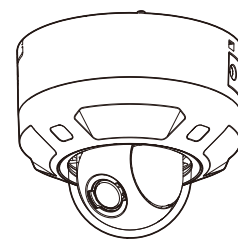

WV-U65300-ZY

- This manual covers the models: WV-S61300 Series ( WV-S61302-Z4, WV-S61301-Z2, WV-S61301-Z1, and WV-S61300-ZY), WV-S65300 Series (WV-S65340-Z4, WV-S65340-Z2, WV-S65302-Z2, WV-S65301-Z1, and WV-S65300-ZY), WV-U61300 Series (WV-U61301-Z2, WV-U61301-Z1, and WV-U61300-ZY), WV-U65300 Series (WV-U65302-Z2, WV-U65301-Z1, and WV-U65300-ZY), WV-S65501-Z1, WV-S61501-Z1.
- The model number is abbreviated in some descriptions in this manual.

# Preface

## About the user manuals

There are 3 sets of operating instructions as follows.

- Operating Instructions (this document): Explains how to perform the settings and how to operate this camera.
- Basic Information: Provides information about “Precautions for use”, “Parts and functions” and “Detail specifications”.
- Installation Guide: Provides information about “Precautions”, “Precautions for installation” and the installation method.

The screens used in these operating instructions show the case of WV-S61301-Z2. Depending on the model used, the screens shown in the explanations may differ to the actual camera screens.

This document provides how to operate and configure the camera using a web browser but it is recommended to use the i-PRO Configuration Tool to configure the camera. The i-PRO Configuration Tool can configure up to 1024 cameras at the same time so that the cameras can be configured efficiently.

For information about the i-PRO configuration tool (iCT), refer to our technical information website <Control No.: C0133>.

### Note

- “<Control No.: C\*\*\*\*>” used in this document should be used to search for information on our technical information website (<https://i-pro.com/global/en/surveillance/training-support/support/technical-information>) and will guide you to the right information.
- The captured screens are used based on the guideline by Microsoft Corporation.
- Operations using Google Chrome is described in this document. For information on the operation verification of the supported web browsers, refer to our technical information website <Control No.: C0132>.
- The default settings of some of the stream-related settings vary as follows depending on the language setting of the browser selected at the time of administrator registration.

Setting items	Language of the browser	
	Languages other than Japanese	Japanese
Transmission priority	VBR	Frame rate
Image quality	3	Normal
Stream(1) -Max bit rate (per client)	<WV-S65300 series> <WV-S61300 series> <WV-U65300 series> <WV-U61300 series> 6144kbps * <WV-S65501-Z1> <WV-S61501-Z1> 12288 kbps *	<WV-S65300 series> <WV-S61300 series> <WV-U65300 series> <WV-U61300 series> 3072kbps * <WV-S65501-Z1> <WV-S61501-Z1> 6144 kbps *
Stream(1) -Smart VIQS	On(Low)	Off

Stream(2) -Max bit rate (per client)	<WV-S65300 series> <WV-S61300 series> <WV-U65300 series> <WV-U61300 series> 4096kbps * <WV-S65501-Z1> <WV-S61501-Z1> 6144 kbps *	<WV-S65300 series> <WV-S61300 series> <WV-U65300 series> <WV-U61300 series> 2048kbps* <WV-S65501-Z1> <WV-S61501-Z1> 3072 kbps *
Stream(3) -Max bit rate (per client)	<WV-S65300 series> <WV-S61300 series> <WV-U65300 series> <WV-U61300 series> 1536kbps * <WV-S65501-Z1> <WV-S61501-Z1> 4096 kbps *	<WV-S65300 series> <WV-S61300 series> <WV-U65300 series> <WV-U61300 series> 768kbps * <WV-S65501-Z1> <WV-S61501-Z1> 2048 kbps *
Stream(4) -Max bit rate (per client)	1536kbps *	768kbps *
Stream(1) - Stream(4) -Refresh interval	2s	1s

## About notations

The following notations are used when describing the functions limited for specified models. The functions without the notations are supported by all models.

Notation	Model	Notation	Model
<b>S613xx</b>	WV-S61302-Z4 WV-S61301-Z2 WV-S61301-Z1 WV-S61300-ZY	<b>Z1</b>	WV-S61301-Z1 WV-S65301-Z1 WV-U61301-Z1 WV-U65301-Z1 WV-S65501-Z1 WV-S61501-Z1
<b>U613xx</b>	WV-U61301-Z2 WV-U61301-Z1 WV-U61300-ZY	<b>Z2</b>	WV-S61301-Z2 WV-S65340-Z2 WV-S65302-Z2 WV-U61301-Z2 WV-U65302-Z2
<b>S653xx</b>	WV-S65340-Z4 WV-S65340-Z2 WV-S65302-Z2 WV-S65301-Z1 WV-S65300-ZY	<b>Z4</b>	WV-S61302-Z4 WV-S65340-Z4
<b>U653xx</b>	WV-U65302-Z2 WV-U65301-Z1 WV-U65300-ZY	<b>ZY</b>	WV-S61300-ZY WV-S65300-ZY WV-U61300-ZY WV-U65300-ZY

Notation	Model	Notation	Model
Endless	WV-S61302-Z4 WV-S65340-Z4 WV-S65302-Z2 WV-S65301-Z1 WV-U65302-Z2 WV-U65301-Z1 WV-S65501-Z1	Non-Endless	WV-S61301-Z2 WV-S65340-Z2 WV-S61301-Z1 WV-S61300-ZY WV-S65300-ZY WV-U61301-Z2 WV-U61301-Z1 WV-U61300-ZY WV-U65300-ZY WV-S61501-Z1

## Abbreviations

The following abbreviations are used in these operating instructions.

Microsoft Windows 10 is described as Windows 10.

Microsoft Windows 11 is described as Windows 11.

microSDXC/microSDHC/microSD memory card is described as SD card or SD memory card.

Universal Plug and Play is described as UPnP™ or UPnP.

# About the initial setting

## 1 Administrator registration

At the time of first access to the camera (or at the time of initialization), the registration screen will be displayed. Define the user name and the password for the administrator, and enter them correctly. Hereafter, they can be used for login.

### Administrator registration

The initial setup of the administrator name and password is required on this screen.  
Manage them safely and be sure not to forget them.

User name (1 to 32 characters)

Password (8 to 32 characters)

Retype password

Note:

- (1) Distinguish between upper- and lower cases.
- (2) Entry of the following is not allowed as a user name: 2-byte characters, and 1-byte symbols " & ; ¥
- (3) Entry of the following is not allowed as a password: 2-byte characters, and 1-byte symbols " &
- (4) For the password, use three or more types of characters from upper- and lowercase alphabetic characters, numbers, and symbols.
- (5) Keep the user name and password at hand so as not to lose.
- (6) It is recommended to change the password periodically.
- (7) Set the password which does not include the user name.

### [User name (1 to 32 characters)]

Enter the user name of the administrator.

**Available number of characters:** 1 - 32 characters

**Unavailable characters:** 2-byte characters, and 1-byte symbols " & ; \

### [Password (8 to 32 characters)]/[Retype password]

Enter the administrator password.

**Available number of characters:** 8 - 32 characters

**Unavailable characters:** 2-byte characters, and 1-byte symbols " &

### Note

- Distinguish between upper- and lower cases.
- For the password, use three or more types of characters from upper- and lowercase alphabetic characters, numeric characters, and symbols.
- Set the password which does not include the user name.

## IMPORTANT

- If you forgot or do not know the password or user name, the camera must be initialized. Because all settings other than preset position settings are deleted when the camera is initialized, make sure to keep the information secure from third parties. Refer to “Parts and functions” section in the Basic Information for more information about initializing the camera.
- It is recommended to change the password periodically.
- Do not use the password already used for other camera or device.

The language/time and date setting screen will be displayed after registering a user name and password of the administrator.

## 2 Language/time and date setting

**Language/time and date setting**

Menu language: Auto | Date/time display: On | Time display format: 24h | Date/time display format: Mmm-DD-YYYY

Date: Oct-12-2022 | Time: 16:41:30 | Date/time position: Upper left

Set PC time to the camera

Time zone: (GMT+09:00) Osaka, Sapporo, Tokyo

Summer time(daylight saving): Out

**Screen setting**

Color: Light | Operation panel layout: Bottom

Set

### Language/time and date setting

#### [Menu language]

Select the language to initially display when the camera is accessed from the following. Auto/English/Japanese/Italian/French/German/Spanish/Chinese/Russian/Portuguese

- **Auto:** The language used by the browser is automatically selected. If the language used by the browser is not supported by the camera, English is selected.
- **Default:** Auto

#### [Date/time display]

Select On/Off to determine whether or not to display the date and time on an image. To hide the date and time, select “Off”.

- **Default:** On

**[Time display format]**

Select the time display format from “24h” and “12h”.

- **Default:** 24h

**[Date/time display format]**

Select a date/time display format. When “2020/04/01 13:10:00” is set for “Date/time” after selecting “24h” for “Time display format”, time & date will be respectively displayed as follows.

- **DD/MM/YYYY:** 01/04/2022 13:10:00
- **MM/DD/YYYY:** 04/01/2022 13:10:00
- **DD/Mmm/YYYY:** 01/Apr/2022 13:10:00
- **YYYY/MM/DD:** 2022/04/01 13:10:00
- **Mmm/DD/YYYY:** Apr/01/2022 13:10:00
- **Default:** Mmm/DD/YYYY

**[Date]**

Click the  button and set a date on the camera.

When  is clicked, the date and time on the PC will be acquired and displayed.

**Available range:** Jan/01/2013 - Dec/31/2035

**[Time]**

Click the  button and set a time on the camera.

When  is clicked, the time on the PC will be acquired and displayed.

**IMPORTANT**

- Use an NTP server when the more accurate time & date setting is required for the system operation. (→“3.11.2.3 Configure the settings relating to the NTP server”)

**[Date/time position]**

Select the position to display the time and date in an image.

- **Upper left:** The information will be displayed at the upper left corner of the screen.
- **Lower left:** The information will be displayed at the lower left corner of the screen.
- **Upper center:** The information will be displayed at the upper center of the screen.
- **Lower center:** The information will be displayed at the lower center of the screen.
- **Upper right:** The information will be displayed at the upper right corner of the screen.
- **Lower right:** The information will be displayed at the lower right corner of the screen.
- **Default:** Upper left

**Note**

- To determine whether to display the date and time on the screen, set it on the “Basic” page of the detailed setting menu. (→“3.5 Configure the basic settings of the camera [Basic]”)

**[Time zone]**

Select a time zone corresponding to the location where the camera is in use.

- **Default:** (GMT +09:00) Osaka, Sapporo, Tokyo

**[Summer time (daylight saving)]**

Select “In”, “Out” or “Auto” to determine whether or not to apply daylight saving time. Configure this setting if the summer time (daylight saving time) is applied in the location where the camera is in use.

- **In:** Applies summer time. An asterisk (\*) will be displayed on the left side of the displayed time and date.
- **Out:** Does not apply summer time.

- **Auto:** Applies summer time in accordance with the settings for “Start time & date” and “End time & date” (month, week, day of the week, time).
- **Default:** Out

### **[Start time & date] [End time & date]**

When “Auto” is selected for “Summer time (daylight saving)”, select the time & date for the start time and the end time (month, week, day of the week, time).

### **Screen setting**

#### **[Color]**

Select “Light” or “Dark” for the background color of each menu of the operation panel (→“ Camera operation panel display button (  )”) and the detailed setting menu. (→“3 Detailed settings”)

**Default:** Light

#### **[Operation panel layout]**

Select “Right”, “Left” or “Bottom” for the layout position of the operation panel. (→“Camera operation panel display button (  )”)

**Default:** Bottom



# Table of Contents

<b>1</b>	<b>Operations</b>	<b>12</b>
1.1	<b>Monitor images on a PC</b>	<b>12</b>
1.1.1	Monitor images from a single camera	12
1.1.2	About the “Live” page	16
1.1.3	Monitor images from multiple cameras	23
1.2	<b>Monitor images on a mobile terminal or tablet device</b>	<b>25</b>
1.2.1	Monitor images on a mobile terminal (smartphone, etc.)	25
1.2.2	Monitor images on a tablet device	32
1.3	<b>Record images on the SD memory card manually</b>	<b>37</b>
1.4	<b>Action at an alarm occurrence</b>	<b>38</b>
1.4.1	Alarm type	38
1.4.2	Action at an alarm occurrence	38
1.5	<b>Display the log list</b>	<b>40</b>
1.6	<b>Playback of images on the SD memory card</b>	<b>43</b>
1.6.1	Playback “JPEG(1)”/“JPEG(2)” images saved to the SD memory card	43
1.6.2	Playback “Stream(1)”/“Stream(2)”/“Stream(3)”/“Stream(4)” images saved to the SD memory card	46
<b>2</b>	<b>Settings</b>	<b>49</b>
2.1	<b>Display the settings panel from a PC</b>	<b>49</b>
2.1.1	How to display the settings panel	49
2.1.2	How to operate the setup menu	49
2.1.3	About the settings panel	51
2.2	<b>Configure the basic settings [Basic]</b>	<b>52</b>
2.3	<b>Configure the settings relating to images [Stream]</b>	<b>53</b>
2.4	<b>Configure the settings relating to image quality [Image quality]</b>	<b>57</b>
2.5	<b>Configure the settings relating to audio [Audio]</b>	<b>59</b>
2.6	<b>Configure the settings relating to the alarm [Alarm]</b>	<b>60</b>
2.7	<b>Shift to the detailed setting and configure the settings relating to screen display [Detailed setting]</b>	<b>61</b>
<b>3</b>	<b>Detailed settings</b>	<b>62</b>
3.1	<b>About the network security</b>	<b>62</b>
3.1.1	Equipped security functions	62
3.2	<b>Display the setup menu from a PC</b>	<b>63</b>
3.2.1	How to display the setup menu	63
3.2.2	How to operate the setup menu	64
3.2.3	About the setup menu window	65
3.3	<b>Perform management of the extension software and the schedule setting [Ext. software] <b>S613xx</b> <b>S653xx</b></b>	<b>67</b>
3.3.1	Perform the installation, uninstallation and version upgrade of the extension software [Software mng.]	67
3.3.2	Set a schedule of the extension software [Operation sched.]	71
3.3.3	Check the control log of extension software [Control log]	72
3.4	<b>Use Easy Setup [Easy Setup]</b>	<b>73</b>
3.4.1	Configure the Internet settings [Internet]	73
3.4.2	Configure an event action [Event action]	75
3.4.2.1	Configure the schedule/alarm (event function type setup menu)	77
3.4.2.2	Alarm: Configure the terminal and VMD (alarm setup menu)	78
3.4.2.3	Alarm: Configure the alarm function type (Alarm function type setup menu)	81
3.4.2.4	Alarm: Configure the details for recording conditions	83
3.4.2.5	Alarm: Configure the output terminal	85

3.4.2.6	Alarm: configure the mail notifications and mail server .....	87
3.4.2.7	Schedule: Configure SD memory recording or FTP/SFTP periodic image transmission (schedule function type setup menu) .....	88
3.4.2.8	Schedule: Set SD memory recording (video recording setup menu) .....	89
3.4.2.9	Schedule: Configure FTP/SFTP periodic image transmission (FTP/SFTP periodic image transmission setup menu) .....	93
<b>3.5</b>	<b>Configure the basic settings of the camera [Basic] .....</b>	<b>96</b>
3.5.1	Configure the basic settings [Basic] .....	96
3.5.2	Configure the settings relating to the SD memory card [SD memory card] .....	101
3.5.3	Configure the settings relating to alteration detection [Alteration detection] .....	109
3.5.4	How to configure alteration detection settings .....	111
3.5.5	Configure the overlay image function [Overlay image] .....	111
<b>3.6</b>	<b>Configure the settings relating to images and audio [Image/Audio] .....</b>	<b>114</b>
3.6.1	Configure the settings relating to the image capture mode [Image] .....	114
3.6.2	Configure the settings relating to JPEG images [Image] .....	115
3.6.3	Configure the settings relating to Stream [Image] .....	117
3.6.4	Configure the settings relating to image adjust, privacy zone, and VIQS [Image quality] .....	124
3.6.4.1	Configure the settings relating to image quality ("Image adjust" setup menu) .....	124
3.6.4.2	Set mask areas .....	133
3.6.4.3	Configure the settings relating to the privacy zone ("Privacy zone" setup menu) .....	135
3.6.4.4	Configure the VIQS setting .....	137
3.6.4.5	Configure the VIQS area .....	139
3.6.5	Configure the settings relating to audio [Audio] .....	141
<b>3.7</b>	<b>Configure the settings relating to PTZ [PTZ] .....</b>	<b>144</b>
3.7.1	Configure the settings relating to the camera operations [Cam. Function] .....	144
3.7.2	Configure the settings relating to the positions [Position] .....	150
3.7.2.1	Configure the settings relating to the preset positions ("Preset position" setup menu) .....	152
3.7.2.2	Configure the settings relating to the preset sequence ("Preset sequence" setup menu) .....	156
3.7.2.3	Configure the settings relating to the auto pan function ("Auto pan" setup menu) .....	158
3.7.2.4	Configure the settings relating to patrol ("Patrol" setup menu) .....	160
3.7.2.5	Configure the settings relating to direction/angle setting ("Direction/Angle" setup menu) .....	162
3.7.2.6	Configure the settings relating to the pan/tilt angle ("Pan/tilt range setting" setup menu) .....	164
3.7.3	Configure the settings relating to auto track ("Auto track" setup menu) <b>S613xx</b> <b>S653xx</b> .....	166
3.7.4	Configure the settings relating to auto track alarm ("Auto track alarm" setup menu) <b>S613xx</b> <b>S653xx</b> .....	171
<b>3.8</b>	<b>Configure the multi-screen settings [Multi-screen] .....</b>	<b>173</b>
<b>3.9</b>	<b>Configure the alarm settings [Alarm] .....</b>	<b>175</b>
3.9.1	Configure the settings relating to the alarm action [Alarm] .....	175
3.9.2	Configure the settings relating to the output terminal [Alarm] .....	178
3.9.3	Change the AUX name [Alarm] .....	180
3.9.4	Configure the settings relating to the camera action on alarm occurrence [Alarm] .....	181
3.9.4.1	Configure the settings relating to Preset per sender ("Preset per sender" setup menu) .....	183
3.9.4.2	Configure settings relating to alarm E-mail notifications .....	184
3.9.4.3	Configure settings relating to FTP/SFTP transmissions of alarm images .....	184

3.9.4.4	Configure settings relating to recording to an SD memory card when an alarm occurs .....	184
3.9.4.5	Configure settings relating to TCP alarm notification when an alarm occurs .....	185
3.9.4.6	Configure settings relating to HTTP alarm notification when an alarm occurs .....	185
3.9.4.7	Configure settings relating to SNMP transmissions of alarm images .....	185
3.9.5	Configure the VMD settings [VMD area] .....	186
3.9.6	Set the VMD areas [VMD area] .....	189
3.9.7	Configure the SCD settings [SCD area] .....	191
3.9.8	Set the SCD areas [SCD area] .....	193
3.9.9	Configure the settings relating to the audio detection [Audio detection] .....	194
3.9.10	Configuration of the settings relating to alarm notification [Notification] .....	196
3.9.10.1	Configure the settings relating to TCP alarm notification .....	196
3.9.10.2	Configure the settings relating to HTTP alarm notification .....	197
<b>3.10</b>	<b>Configure the settings relating to the authentication [User mng.] .....</b>	<b>199</b>
3.10.1	Configure the settings relating to the user authentication [User auth.] .....	199
3.10.2	Configure the settings relating to the host authentication [Host auth.] .....	202
3.10.3	Configure IEEE 802.1X [IEEE 802.1X] .....	203
3.10.4	Configure the data encryption settings [Data encryption] .....	207
<b>3.11</b>	<b>Configuring the network settings [Network] .....</b>	<b>209</b>
3.11.1	Configure the network settings [Network] .....	209
3.11.2	Configure advanced network settings [Advanced] .....	214
3.11.2.1	Configure the settings related to sending E-mails .....	214
3.11.2.2	Add FTP/SFTP image transmission function .....	218
3.11.2.3	Configure the settings relating to the NTP server .....	223
3.11.2.4	Configure the UPnP settings .....	224
3.11.2.5	Configure the HTTPS settings .....	225
3.11.2.6	Configure the settings relating to DDNS .....	227
3.11.2.7	Configure the settings relating to SNMP .....	227
3.11.2.8	Configure the QoS settings .....	232
3.11.2.9	Configure the SRTP settings .....	232
3.11.2.10	Configure the MQTT settings .....	233
3.11.2.11	Configure the LLDP settings .....	236
3.11.3	How to configure HTTPS settings .....	238
3.11.4	How to configure the settings relating to DDNS .....	238
3.11.4.1	Configuration of the DDNS service (Example of the "Viewnetcam.com" service) .....	239
3.11.4.2	When using "Dynamic DNS Update" .....	242
3.11.4.3	When using "Dynamic DNS Update(DHCP)" .....	242
<b>3.12</b>	<b>Configure the settings relating to the schedules [Schedule] .....</b>	<b>243</b>
3.12.1	How to set the schedules .....	246
3.12.2	How to delete the set schedule .....	248
<b>3.13</b>	<b>Maintenance of the camera [Maintenance] .....</b>	<b>249</b>
3.13.1	Check the system log [System log] .....	249
3.13.2	Upgrade the firmware [Upgrade] .....	250
3.13.3	Check the status [Status] .....	251
3.13.4	Reset the settings/Reboot the camera [Default reset] .....	255
3.13.5	Settings data/backing up or restoring logs [Data] .....	256
<b>3.14</b>	<b>Display our support website [Support] .....</b>	<b>257</b>
<b>4</b>	<b>Others .....</b>	<b>258</b>
4.1	About the displayed system log .....	258
4.2	Troubleshooting .....	264
4.3	Directory structure of SD memory card .....	271

# 1 Operations

## 1.1 Monitor images on a PC

The following are descriptions of how to monitor images from the camera on a PC.

### 1.1.1 Monitor images from a single camera

1. Start up the web browser.
2. Enter the IP address designated using the “IP Setting Software” in the address box of the browser.
  - **Example when entering an IPv4 address:** http://URL registered using IPv4 address  
http://192.168.0.10/
  - **Example when entering an IPv6 address:** http://[URL registered using IPv6 address]  
http://[2001:db8::10]/

#### <Example of IPv4 access>



#### **IMPORTANT**

- When the HTTP port number is changed from “80”, enter “http://IP address of the camera + : (colon) + port number” in the address box of the browser. (Example: http://192.168.0.11:8080)
- When the PC is in a local network, configure the proxy server setting of the browser (under [Internet Options...] under [Tools] of the menu bar) to bypass the proxy server for the local address.

#### **Note**

- Refer to video clips <Control No.: P0002> and <Control No.: P0003> on the support video page on our technical information website for the case where [HTTPS] is selected for “HTTPS” - “Connection” on the [Advanced] tab of the “Network” page. (→“3.11.1 Configure the network settings [Network]”)

3. Press the [Enter] key on the keyboard.  
→ The window with the user name and password entry fields will be displayed.

**Note**

- When “Off” is selected for “User auth.”, the authentication window will not be displayed before displaying live images for the user name and password entries.
4. Click the [OK] button after entering the user name and the password.  
→ The “Live” page will be displayed. Refer to “1.1.2 About the “Live” page” for further information about the “Live” page.

**IMPORTANT**

- It is recommended to change the password periodically.
- When displaying multiple H.265 (or H.264) images on a PC, images may not be displayed depending on the performance of the PC.

**Note**

- The maximum number of concurrent access user is 24 including users who is receiving H.265 (or H.264) images and users who are receiving JPEG images. Depending on the set values for “Bandwidth control(bit rate)” and “Max bit rate (per client)\*”, the maximum concurrent access number may be 24 or less users. When 24 users are concurrently accessing, the access limit message will be displayed for users who subsequently attempt to access. When “Multicast” is selected for “Transmission type” of “Stream”, only the first user who accessed to monitor H.265 (or H.264) images will be included in the maximum number. The second and subsequent users who are monitoring H.265 (or H.264) images will not be included in the maximum number.

## 1 Operations

- If you set the “Stream transmission” (→“Stream(1)/ Stream(2)/ Stream(3)/ Stream(4)”) to “On”, an H.265 (or H.264) image will be displayed based on the settings of the “Stream encoding format”. A JPEG image can be displayed even if the “Stream transmission” is set to “On”. However, in that case, the refresh interval of the JPEG image will be restricted as follows.

**<WV-S65300 series> <WV-S61300 series> <WV-U65300 series> <WV-U61300 series>**

Image capture mode	Stream transmission			
	On	Off	On	Off
	JPEG(1)	JPEG(2)	JPEG(1)	JPEG(2)
4:3 mode(30fps mode)	max. 5 fps	max. 15 fps	max. 30 fps	max. 30 fps
16:9 mode(30fps mode)				
16:9 mode(60fps mode)				
4:3 mode(25fps mode)	max. 4.2 fps	max. 12.5 fps	max. 25 fps	max. 25 fps
16:9 mode(25fps mode)		max. 4.2 fps		
16:9 mode(50fps mode)				
4:3 mode(15fps mode)	max. 5 fps	max. 15 fps	max. 15 fps	max. 15 fps
4:3 mode(12.5fps mode)	max. 4.2 fps	max. 12.5 fps	max. 12.5 fps	max. 12.5 fps

**<WV-S65501-Z1> <WV-S61501-Z1>**

Image capture mode	Stream transmission			
	On	Off	On	Off
	JPEG(1)	JPEG(2)	JPEG(1)	JPEG(2)
16:9 mode (30fps mode)	max. 1 fps (at 3072x1728) max. 2 fps (at 2560x1440) max. 5 fps (at 1920x1080/ 1280x720/ 640x360/ 320x180)	max. 15 fps	max. 30 fps	max. 30 fps
16:9 mode (25fps mode)	max. 1 fps (at 3072x1728) max. 2.1 fps (at 2560x1440) max. 4.2 fps (at 1920x1080/ 1280x720/ 640x360/ 320x180)	max. 12.5 fps	max. 25 fps	max. 25 fps
4:3 mode(30fps mode)	max. 1 fps (at 3072x2304) max. 2 fps (at 2560x1920) max. 5 fps (at 1280x960/ 800x600/ VGA/ 400x300/ QVGA)	max. 15 fps	max. 30 fps	max. 30 fps

Image capture mode	Stream transmission			
	On	Off	On	Off
	JPEG(1)	JPEG(2)	JPEG(1)	JPEG(2)
4:3 mode(25fps mode)	max. 1 fps (at 3072x2304) max. 2.1 fps (at 2560x1920) max. 4.2 fps (at 1280x960/ 800x600/ VGA/ 400x300/ QVGA)	max. 12.5 fps	max. 25 fps	max. 25 fps

- The refresh interval may become longer depending on a network environment, PC performance, photographic subject, access traffic, etc.

## 1.1.2 About the “Live” page

### Note

- The buttons and setting items displayed on the “Live” page can be changed depending on the user rights of the accessing user. You can set the user right settings from “User auth.” under “User mng.”. (→“3.10.1 Configure the settings relating to the user authentication [User auth.]”)

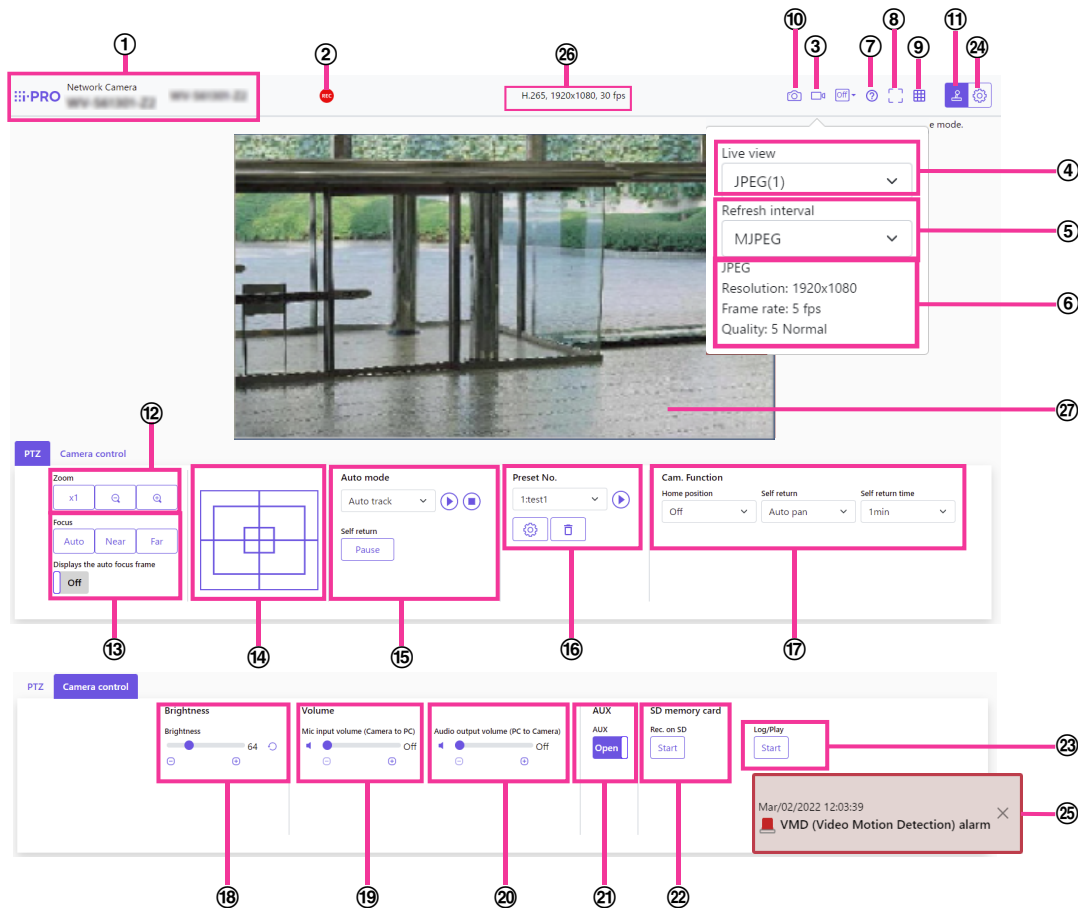

① **Camera title**

The camera title entered for “Camera title” on the [Basic] tab will be displayed. (→[Camera title])

② **SD recording status indicator**

The status of the SD recording can be checked with this indicator.

When the SD recording starts, the SD recording status indicator will light red. It will go off when the SD recording stops.

This indicator will be displayed when “Manual” or “Schedule” is selected for “Save trigger” on the setup menu. (→“3.5.2 Configure the settings relating to the SD memory card [SD memory card]”)

③ **Stream selection display button**

Switches between display and hide a popover on the stream selection screen. On the stream selection screen, [Live view] and others can be set.

④ **Stream - [Live view] pull-down menu**

You can select and switch to the image to be displayed in the main area from the following:

Stream(1)/ Stream(2)/ Stream(3)/ Stream(4)/ JPEG(1)/ JPEG(2)/ JPEG(3)/ Multi-screen  
 Images will be displayed in the main area based on the contents set in Stream(1) – (4) (→“Stream(1)/ Stream(2)/ Stream(3)/ Stream(4)”), JPEG(1) - (2) (→“JPEG”) and Multi-screen. (→3.8 Configure the multi-screen settings [Multi-screen])



Also the first stream displayed when you accessed the camera can be set from “Initial display stream” of the [Image] tab. For “Multi-screen”, you can set the “Initial display” in the [Multi-screen] tab.

#### **Note**

- When the image capture size is larger than “1280x720”, the image may become smaller than the actual size depending on the window size of the browser.

#### ⑤ **Stream - [Refresh interval] pull-down menu**

This pull-down menu will be displayed only when a JPEG image is displayed. Use it to select the display method of the JPEG image.

- **MJPEG:** Displays JPEG images successively (MJPEG: Motion JPEG).
- **Refresh interval: 1s/ Refresh interval: 3s/ Refresh interval: 5s/ Refresh interval: 10s/ Refresh interval: 30s/ Refresh interval: 60s:** Refreshes JPEG format (still images) images at the specified interval.

#### **Note**

- Depending on the network environment or the PC used, JPEG format (still images) images may not be refreshed at the specified interval.

#### ⑥ **Stream - Stream information display**

Displays the setup for stream encoding format, image capture size, bit rate, and frame rate for the live view of a stream.

#### **Note**

- Displays the values set in the stream. The actual bit rate and frame rate vary depending on the network environment and the used PC.

#### ⑦ **Support button**

When this button is clicked, our technical information website will be displayed in a newly opened window. Our technical information website contains technical information, FAQ, and other information.

#### ⑧ **Full screen button**

A new window will open and images will be displayed on a full screen.

#### ⑨ **[Grid display] buttons**

Select On/Off to determine whether or not to display the grid that can be used for position adjustment of this product when using the extension software.

For the adjustable size for each extension software, refer to our technical information website <Control No.: C0320>.

#### ⑩ **Snap shot button**

Click this button to take a picture (a still picture). The picture will be displayed on a newly opened window. When right-clicking on an image, the image can be saved using the function of the extension software. When “Print” is selected, printer output is enabled. When selecting “Quad”, this button will not be displayed.

#### **Note**

- When it takes longer than the specified period to obtain the snap shot picture due to the network environment, the snap shot picture may not be displayed.
- If the image capture size specified for JPEG cannot be obtained, JPEG images are displayed with the image capture size that could be obtained.  
Therefore, when JPEG images obtained with snap shot are displayed on a PC, the displayed image size may differ from the captured sized.

#### ⑪ **Camera operation panel display button** ( )

Switches between display and hide the camera control panel. On the camera control panel, [Brightness] and others can be set.

#### ⑫ **PTZ panel - [Zoom] buttons**

The zoom can be adjusted manually.

-  : Click this button to adjust the zoom ratio to the “Wide” side until x1.0.

- **x1**: Click this button to set the zoom ratio to x1.0.
- **+**: Click this button to adjust the zoom ratio to the “Tele” side.

**13 PTZ panel - [Focus] buttons**

The focus can be adjusted manually.

- **[Auto]**: Click this button to adjust the focus automatically.
- **[Near]**: Click this button to adjust the focus to the “Near” side.
- **[Far]**: Click this button to adjust the focus to the “Far” side.
- **[Displays the auto focus frame]**: When “On” is selected and a frame is drawn on the screen, the focus (focal point) will be adjusted in accordance with the drawn frame.

**Note**

- When shooting the following place or the following subjects, focus may not be adjusted automatically. Adjust the focus manually.
  - Shiny or strongly reflective subject
  - Subject through the glass with dew or smudge
  - Two subjects whose distances from the camera are different
  - Less contrast subject (e.g. white wall)
  - Horizontal-striped subject such as a window blind
  - Inclined subject
  - Dark subjects

**14 PTZ panel - Control pad/buttons**

Left-click on the control pad or buttons to adjust the horizontal/vertical position (panning/tilting) of the camera.

Panning/tilting speed will be faster if a clicked point gets farther from the center point of the control pad. It is also possible to pan/tilt the camera by dragging the mouse. Zoom and focus can be adjusted by right-clicking.

When an upper/lower area of the control pad is right-clicked, the displayed image will be zoomed in/out on. When the left half of the control pad is clicked, the focus (focal point) will be adjusted to the “Near” side. When the right half of the control pad is clicked, the focus (focal point) will be adjusted to the “Far” side.

**15 PTZ panel - [Auto mode]**

When an operation is selected from the pull-down menu, the selected operation will start. The selected operation will stop when the camera (panning/ tilting/ zooming/ focusing) is operated or when an action to be taken according to the settings for “Self return” (→“3.7.1 Configure the settings relating to the camera operations [Cam. Function]”) or for “Camera action on alarm” (→“3.9.4 Configure the settings relating to the camera action on alarm occurrence [Alarm]”) starts.

- **Auto track**: When an object that is of the type set in advance (→“3.7.3 Configure the settings relating to auto track (“Auto track” setup menu) **S613xx** **S653xx**”) so as to be detected is detected, the object will automatically be tracked. **S613xx** **S653xx**
- **Auto pan**: Automatically pans between the start position and the end position set in advance (→“3.7.2.3 Configure the settings relating to the auto pan function (“Auto pan” setup menu)”). Even when the camera is operated for zooming or focusing, the camera continues panning. (However, panning will stop when the zoom button (x1) is clicked.)
- **Preset sequence 1, Preset sequence 2, Preset sequence 3**: Automatically moves to the preset positions (→“3.7.2.2 Configure the settings relating to the preset sequence (“Preset sequence” setup menu)”) orderly starting from the lowest preset position number.

**Note**

- When the content of [Self return] (→“3.7.1 Configure the settings relating to the camera operations [Cam. Function]”) is executed for the time set in [Self return time] (→“3.7.1 Configure the settings relating to the camera operations [Cam. Function]”) during operation in the auto mode, the operation in the auto mode will stop.

**⑩ PTZ panel - [Preset]**

Select a preset position from the pull-down menu and click the [Go] button. The camera will move to the selected preset position. (→“3.7.2.2 Configure the settings relating to the preset sequence (“Preset sequence” setup menu)”)

“H” next to the preset position number indicates the home position. When “Home position” is selected, the camera will move to the home position. (→“3.7.1 Configure the settings relating to the camera operations [Cam. Function]”)

When the “Preset ID” is registered for a preset position, the registered position title will be displayed next to the preset position number.

**⑪ PTZ panel - [Cam. Function] [Home position]**

A preset position (→“3.7.2.1 Configure the settings relating to the preset positions (“Preset position” setup menu)”) can be set as the home position. When a preset position is set as the home position, “H” will be displayed next to the preset position number.

**Default:** Off

**Note**

- To move the camera to the home position when the power of the camera is turned on, select “Home position” for “Self return”.

**[Self return]**

When the time set for “Self return time” has passed after manual operations of the camera, the camera will automatically be in the selected mode.

- **Off:** Self return is not performed.
- **Home position:** When the set time has passed, the camera will move to the home position automatically.
- **Auto pan:** When the set time has passed, the camera will start the auto-panning operation.
- **Preset sequence 1:** When the set time has passed, the camera will start the sequence 1 operation.
- **Preset sequence 2:** When the set time has passed, the camera will start the sequence 2 operation.
- **Preset sequence 3:** When the set time has passed, the camera will start the sequence 3 operation.
- **Patrol:** When the set time has passed, the camera will start the patrol.
- **Default:** Off

**Note**

- This function is also useful to automatically set the camera in a specific mode when the power of the camera is turned on.
- The self return function works even when the setup menu is displayed.
- “Patrol” can be set only when the patrol function is enabled. (→“3.7.2.4 Configure the settings relating to patrol (“Patrol” setup menu)”)
- Only “Patrol 1” can be set for “Patrol”. “Patrol 2”, “Patrol 3” and “Patrol 4” are unavailable.
- “Preset sequence” can be set only when the preset sequence function is enabled. (→“3.7.2.2 Configure the settings relating to the preset sequence (“Preset sequence” setup menu)”)



**[Self return time]**

Select a waiting time (amount of time until the camera starts the selected operation after the end of the manual operations) from the following.

10s/ 20s/ 30s/ 1min/ 2min/ 3min/ 5min/ 10min/ 20min/ 30min/ 60min

**Default:** 1min



**⑫ Camera control panel - [Brightness]**

Click the  button to make the image brighter, or click the  button to make the image darker. When the  button is clicked, the setting will be reset to the default.

### ⑱ Camera control panel - [Mic input volume (Camera to PC)]

This item is available only when the settings are as follows. (→“2.5 Configure the settings relating to audio [Audio]”)

- When “Mic input”, “Interactive(Full-duplex)” or “Interactive(Half-duplex)” is selected for “Audio transmission mode”
- When “AAC-LC” is selected for “Audio input encoding format”

The mic input volume can be adjusted in 4 steps (Off/Low/Middle/High) by clicking the  button or the  button or by moving the volume cursor.



When the mic input button is clicked, the mic input (Camera to PC) will be turned on/off.

#### **Note**

- When “Audio volume control mode” is set to “Adjust Mic input” in the setup menu, the volume cursor is not displayed when using “Audio recording” or “Audio detection”. (→“2.5 Configure the settings relating to audio [Audio]”)
- When the camera is restarted, the adjusted volume level (for the reception) will return to the level that had been set on the [Audio] tab on the setup menu. (→“2.5 Configure the settings relating to audio [Audio]”)
- Actual volume level will change in four steps even though the volume cursor can be adjusted minutely.
- If multiple camera browsers are open at the same time on the same computer, audio cannot be heard from the camera browsers that were opened later. Please only access 1 camera at a time.
- If the network communication is unstable, audio input may stop. In this case, resume the mic input by turning the mic input button off and on.

### ⑳ Camera control panel - [Audio output volume (PC to Camera)]

This item is available only when “Audio output”, “Interactive(Full-duplex)” or “Interactive(Half-duplex)” is selected for “Audio transmission mode” on the setup menu. (→“2.5 Configure the settings relating to audio [Audio]”)

The audio output volume can be adjusted in 4 steps (Off/ Low/ Middle/ High) by clicking the  button or the  button or by moving the volume cursor. When the audio output button is clicked, the audio output (PC to Camera) will be turned on/off.

#### **Note**

- Audio transmission is available only when connected with HTTPS.
- When a user is using the audio transmission function with “Interactive(Half-duplex)” selected, the receiver button and the transmission button will be inoperable for the other users. When “Interactive(Full-duplex)” is selected, the transmission button is inoperable for other users.
- The maximum duration of a single audio output is the audio output duration set in the [Audio] tab on the “Image/Audio” page. Audio output stops when the specified audio output duration has passed. To turn the audio transmission function on, click the [Audio output] button again.
- When the camera is restarted, the adjusted volume level (for both the audio transmission and reception) will return to the level that had been set on the [Audio] tab on the “Image/Audio” page. (→“2.5 Configure the settings relating to audio [Audio]”)
- Actual volume level will change in four steps even though the volume cursor can be adjusted minutely.

### ㉑ Camera control panel - [AUX] button

These buttons will be displayed only when “Terminal 3” of “Alarm” is set to “AUX output” on the setup menu. (→“3.4.2.2 Alarm: Configure the terminal and VMD (alarm setup menu)”)

- **[Open] button:** The status of the AUX connector will be open.
- **[Close] button:** The status of the AUX connector will be closed.

**Note**

- The names of “AUX”, “Open” and “Close” can be changed. (→“3.9.3 Change the AUX name [Alarm]”)

**②② [SD memory card] - [Rec. on SD]**

This item is available only when “Manual” is selected for “Save trigger” on the [SD memory card] tab. (→[Save trigger])

Click the [Start] button to manually record images on the SD memory card. Refer to “1.3 Record images on the SD memory card manually” for descriptions of how to manually record images on the SD memory card.

**②③ [SD memory card] - [Log/Play]**

When the [Start] button is clicked, the log list will be displayed and images saved on the SD memory card can be played. Refer to “1.5 Display the log list” for further information about the log list and for how to play images on the SD memory card.

**②④ Set button (  )**

Switches between display and hide the settings panel. (→“2 Settings”)

**②⑤ Alarm occurrence notification**

When an occurrence notification occurs, a popover will be displayed. When the [x] button is clicked, the output terminal will be reset and this button will disappear. (→“1.4 Action at an alarm occurrence”)

**Note**

- Since the alarm occurrence indication is not coupled to recording images to the SD memory card, forwarding E-mails, or other operations, check the settings of each operation separately.

**②⑥ Stream information display**

Displays the stream encoding format, image capture size and frame rate for live stream.

**②⑦ Main area**

Displays images from the camera.

The current time and date will be displayed according to the settings configured for “Time display format” and “Date/time display format”. (→“3.5.1 Configure the basic settings [Basic]”)

In addition, when being adjusted, the status of brightness (→[Brightness]) will be displayed as well as the characters configured for “Camera title on screen” (→[Camera title on screen]).

The number of lines to be displayed is two.

When displaying H.265 with a high bit rate, the stream may display only i-frames.

Click a desired point in the main area on the “Live” page that is to be the center of the angle of view. The camera moves to adjust the position in order to set the clicked point as the center.

When selecting an area in the main area by dragging the mouse, the selected area will be located at the center of the main area. In this case, the zoom ratio will be adjusted automatically.

A zoom operation can be performed using the mouse wheel.

**S613xx**

**S653xx**

When the main area of the “Live” page is right-clicked, “Auto track” starts for the clicked object.

Depending on the targeted object or its surroundings, “Auto track” may not perform normally.

**Note**

- When the camera is operated by a user with a low access level, images displayed on the screen may be changed temporarily. This does not affect operation of the camera.
- Depending on the PC in use, screen tearing\* may occur when the shooting scene drastically changes due to the GDI restrictions of the OS.  
\*A phenomenon in which portions of the screen are displayed out of alignment.
- When the data encryption function is enabled, images cannot be monitored on the “Live” page. Please use our supported devices.
- When the displayed image is highly zoomed, the clicked point may not always be located at the center of the image.

## 1 Operations

---

- As the tilt angle approaches 90°, because the difference between the specified position and the actual direction in which the camera is moving increases, the camera may not move to the specified angle of view.
- If dragging the mouse to the angle exceeding the rotation range of the camera, the camera will change its direction to the operable position and adjusts the zoom ratio automatically.

### 1.1.3 Monitor images from multiple cameras

Images from multiple cameras can be displayed on a multi-screen. Images from 4, 9, and up to 16 cameras can be displayed simultaneously. To display images on a multi-screen, it is necessary to register cameras in advance. 4 cameras can be registered as a group and up to 4 groups (16 cameras) can be registered. (→“3.8 Configure the multi-screen settings [Multi-screen]”)

#### IMPORTANT

- When 16 screens are used for the display, only still images (JPEG) can be refreshed.

#### Note

- For further information about “Network Camera Recorder with Viewer Software Lite”, which is suited to viewing images from several cameras, refer to our technical information website <Control No.: C0301>.
- When you have registered a camera with the authentication function enabled, it is necessary to access the camera and register the user name of “Administrator” and password in the web browser in advance. Refer to our technical information website <Control No.: C0302> for information about the terms and conditions for use of multi-screen.

1. From the “Live view” pull-down menu in the “Live” page, select “Multi-screen”.

→ Images from the registered cameras will be displayed on a selected multi-screen (screen can be split up to 16 areas). The following are instructions when displaying on a 4-split screen.

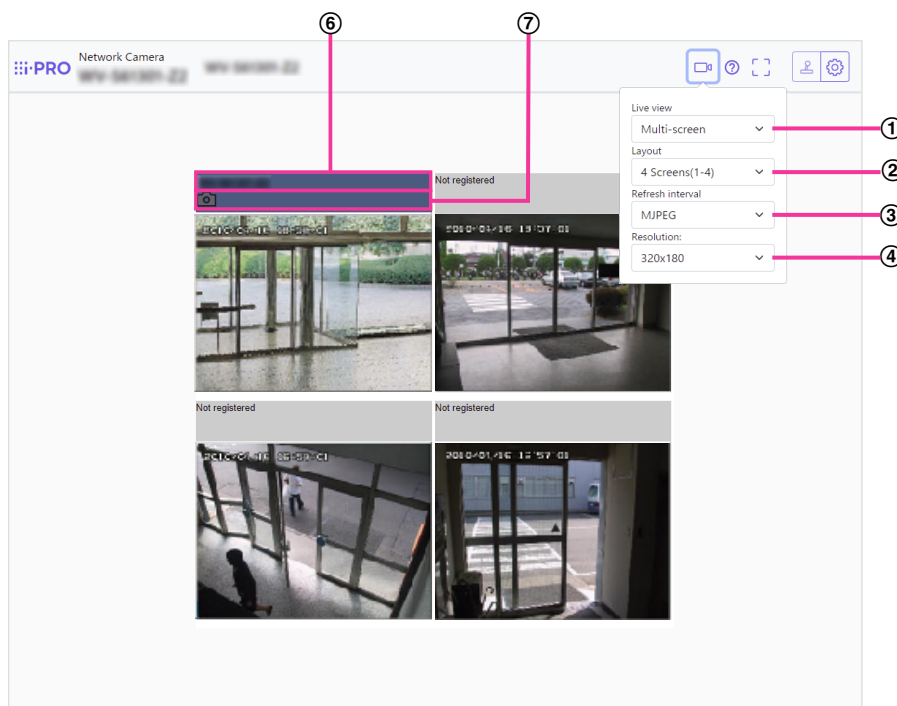

① **“Live view” pull-down menu**

Select the image displayed in the main area.

② **[Layout] pull-down menu**

Select from the pull-down menu to display images from cameras in multi-screens of 4 to 9 or even 16 screens.

③ **[Refresh interval] pull-down menu**

Select from the pull-down menu and switch between video (MJPEG) and still images (JPEG).

For still images (JPEG), select the refresh interval (Refresh interval : 1s/Refresh interval : 3s/Refresh interval : 5s/Refresh interval : 10s/Refresh interval : 30s/Refresh interval : 60s) for camera images.

When the 16 screen layout is used, Refresh interval : 1s cannot be selected.

④ **[Image capture size] pull-down menu**

Select the image capture size from the pull-down menu to change it.

When you select "4 Screens" in the [Layout] pull-down menu, the image capture size of the camera changes.

- Switching between 320x180 (default) and 640x360

⑤ **Full screen display**

If you press the full screen button, the display of the camera image will be maximized. If you click the [x] button in the full screen display, the display size will be reset to original size.

⑥ **Camera title**

If you click the camera title, live images from the corresponding camera will be displayed on the "Live" page of the newly opened window.

⑦ **Camera control bar**

Can be used to get snap shot of JPEG images.

**Note**

- The frame rate may drop depending on the network environment and number of accessing users.
- If the image capture size specified for JPEG cannot be obtained, a JPEG image with an image capture size that could be obtained is displayed. Therefore, when JPEG images obtained with snap shot are displayed on a PC, the displayed image size may differ from the captured sized.



## 1.2 Monitor images on a mobile terminal or tablet device

### 1.2.1 Monitor images on a mobile terminal (smartphone, etc.)

It is possible to connect to the camera using a mobile terminal via the Internet and monitor images (MJPEG or JPEG) from the camera on the screen of the mobile terminal. It is also possible to refresh images to display the latest image.

The compatible mobile terminals are shown as follows. (As of April, 2020)

- iPad, iPhone (iOS 8 or later)
- Android™ mobile terminals

When an Android terminal is used, an MJPEG format image is displayed by the Firefox browser, and a JPEG format image is displayed by the standard browser.

#### **IMPORTANT**

- When the authentication window is displayed, enter the user name and password.  
To enhance the security, it is recommended to change the password periodically. (→“3.10.1 Configure the settings relating to the user authentication [User auth.]”)

#### **Note**

- It is necessary to configure the network settings of the mobile terminal in advance to connect to the Internet and monitor images from the camera. (→“3.11 Configuring the network settings [Network]”)
1. Access to “http://IP address/cam”<sup>1</sup> or “http://Host name registered in the DDNS server/cam”<sup>2</sup> using a mobile terminal.  
→ Images from the camera will be displayed.

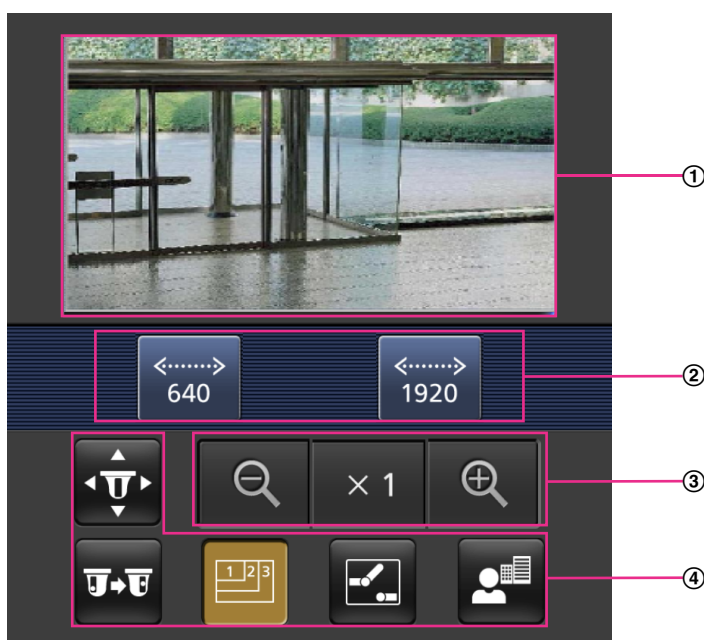

- ① Live images area  
Displays images from the camera.

## 1 Operations

---

- ② Operation buttons area  
When functions are selected in the function selection area ③, buttons to operate those functions are displayed.
- ③ Zoom operation area  
Buttons to operate the zoom are displayed.
- ④ Function selection area  
When functions that can be operated are selected, operation buttons are displayed in the operation buttons area ②.

### Note

- The operations button displayed on the mobile terminal screen may not be available depending on the user rights and access level of the accessing user. To display the operations button, it is necessary to set the user rights and access level ("User auth." in "User mng."). (→"3.10.1 Configure the settings relating to the user authentication [User auth.]")



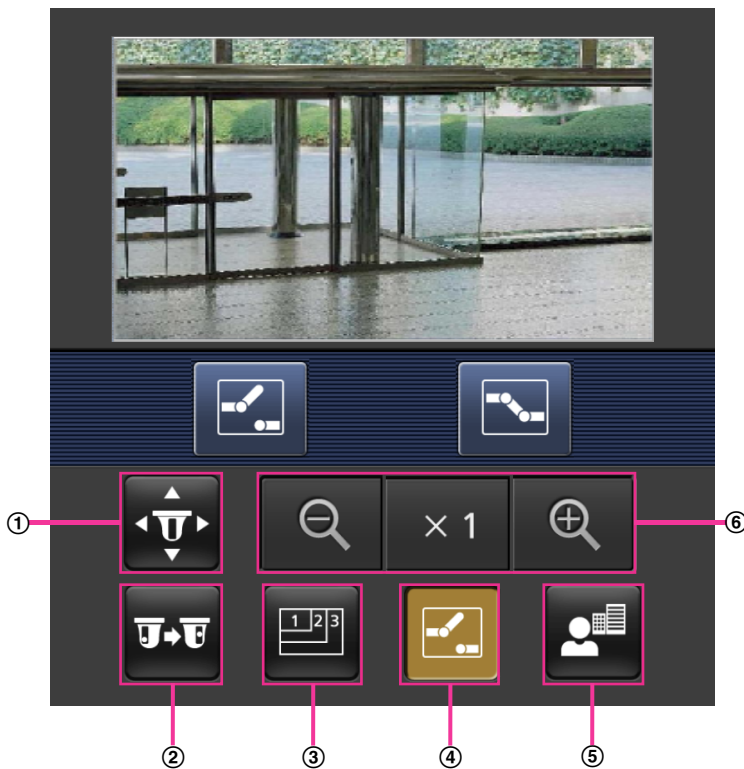

2. Click the button of the function that you want to operate.





- ① Pan/Tilt
- ② Preset
- ③ Resolution control
- ④ AUX control
- ⑤ Focus display
- ⑥ Zoom display

Each function is explained below.

**① Pan/Tilt**

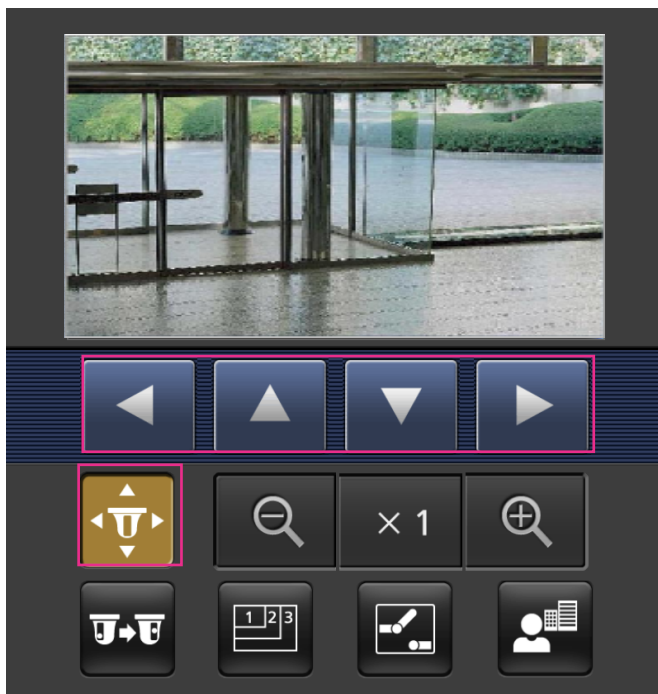
Press the  button to display the buttons used to operate pan/tilt on the screen. The pan/tilt can be adjusted in each direction with the , , , and  buttons.

**② Preset**

Press the  button to display the buttons used to select the preset position on the screen. Camera images are displayed of the registered preset camera directions according to the preset numbers selected from the buttons.

- Only position numbers 1-4 for the preset positions are displayed.
- Only registered preset positions are displayed. Unregistered preset positions are not displayed.

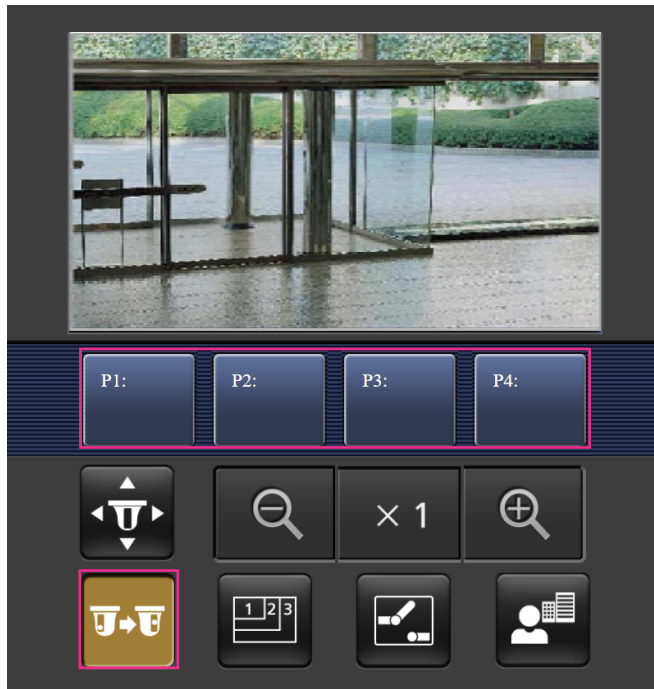

### ③ Resolution control



Press the  button to display the buttons used to select the resolution on the screen.

The resolution can be changed by selecting a resolution setting from the buttons.

Images are displayed in the image capture size selected in “JPEG(1)” or “JPEG(2)” of [JPEG] on the [Image] tab.



#### ④ AUX control



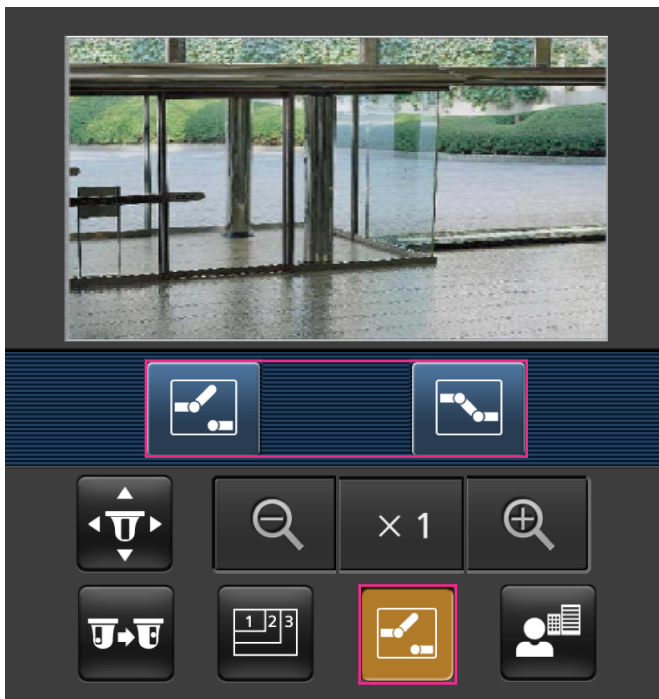

Press the  button to display the buttons used to operate the AUX output on the screen. The AUX output terminals can be controlled with the  and  buttons.

This function is only displayed when [Terminal 3] is set to [AUX output] on the settings menu.  
(→“3.9.1 Configure the settings relating to the alarm action [Alarm]”)





## 1 Operations

### ⑤ Focus display

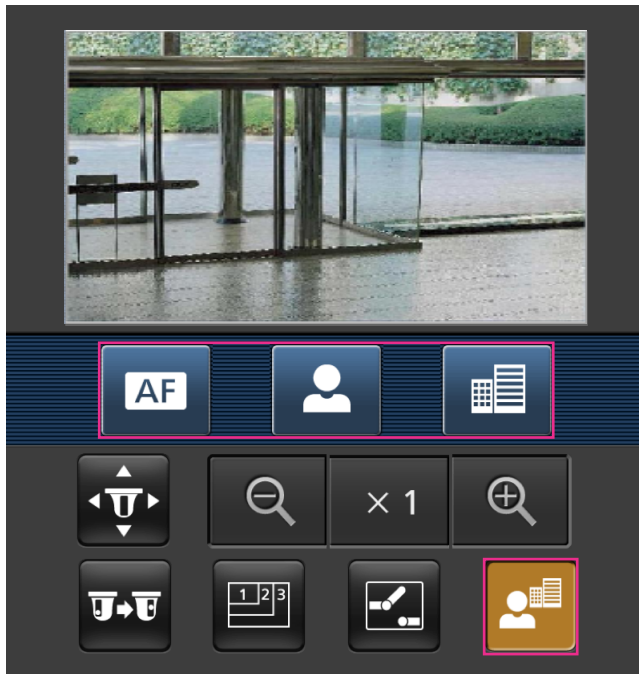
Press the  button to display the buttons used to operate the focus on the screen. The camera's focus can be operated with the , , and  buttons.



### ⑥ Zoom display

The camera's zoom can be operated with the , , and  buttons.

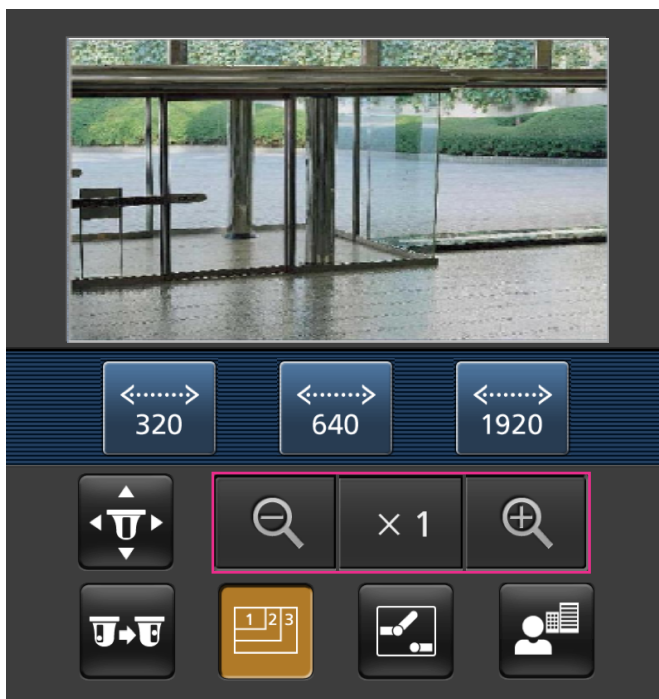

**Note**

- You can change the image size displayed on the mobile terminal by accessing the following addresses.
  - Large display: `http://IP address/cam/dl`
  - Medium display: `http://IP address/cam/dm`
  - Small display: `http://IP address/cam/ds`
- When the resolution is changed by the resolution control, the displayed resolution changes but the image size remains the same.
- When the HTTP port number is changed from “80”, enter “`http://IP address: (colon) + port number/cam`”<sup>1</sup> in the address box of the browser. When using the DDNS function, access to “`http://Host name registered in the DDNS server: (colon) + port number/cam`”<sup>2</sup>.
- When “HTTPS” is selected for “HTTPS” - “Connection” on the [Advanced] tab of the “Network” page, enter as follows.  
“`https://IP address: (colon) + port number/cam`” or “`https://Host name registered in the DDNS server: (colon) + port number/cam`”
- When the authentication window is displayed, enter the user name of an administrator or user and password. Depending on the mobile terminal in use, password entry may be required each time the screen is switched.
- It is impossible to send and receive audio using a mobile terminal.
- Depending on the mobile terminal in use, larger size images may not be displayed. In this case, selecting a setting close to the lowest quality setting for “Image quality setting” of “JPEG” (→“3.6.2 Configure the settings relating to JPEG images [Image]”) may sometimes solve this problem.
- Depending on the mobile terminal in use or its contract plan, it may be impossible to access.

---

<sup>1</sup> IP address is the global WAN IP address of the router that can be accessed via the Internet. However, when accessing the same LAN as the camera with a wireless compatible mobile terminal, the IP address is the local IP address.

<sup>2</sup> Only when accessing the camera via the Internet.

## 1.2.2 Monitor images on a tablet device

It is possible to connect to the camera using a tablet device via the Internet and monitor images (MJPEG or JPEG) from the camera on the screen of the tablet device. It is also possible to refresh images to display the latest image.

The compatible mobile terminals are shown as follows. (As of April, 2020)

- iPad, iPhone (iOS 8 or later)
- Android™ mobile terminals

When an Android terminal is used, an MJPEG format image is displayed by the Firefox® browser, and a JPEG format image is displayed by the standard browser.

### IMPORTANT

- When the authentication window is displayed, enter the user name and password.  
To enhance the security, it is recommended to change the password periodically. (→“3.9.1 Configure the settings relating to the alarm action [Alarm]”)

### Note

- It is necessary to configure the network settings of the tablet device in advance to connect to the Internet and monitor images from the camera. (→“3.10.1 Configure the settings relating to the user authentication [User auth.]”)
  - Depending on the device model, the same screen as the PC may be displayed. In that case, access to “http://IP address/live/tab.html” or “http://Host name registered in the DDNS server/live/tab.html”.
1. Access to “http://IP address/” or “http://Host name registered in the DDNS server/” using a tablet device.  
→ Images from the camera will be displayed.

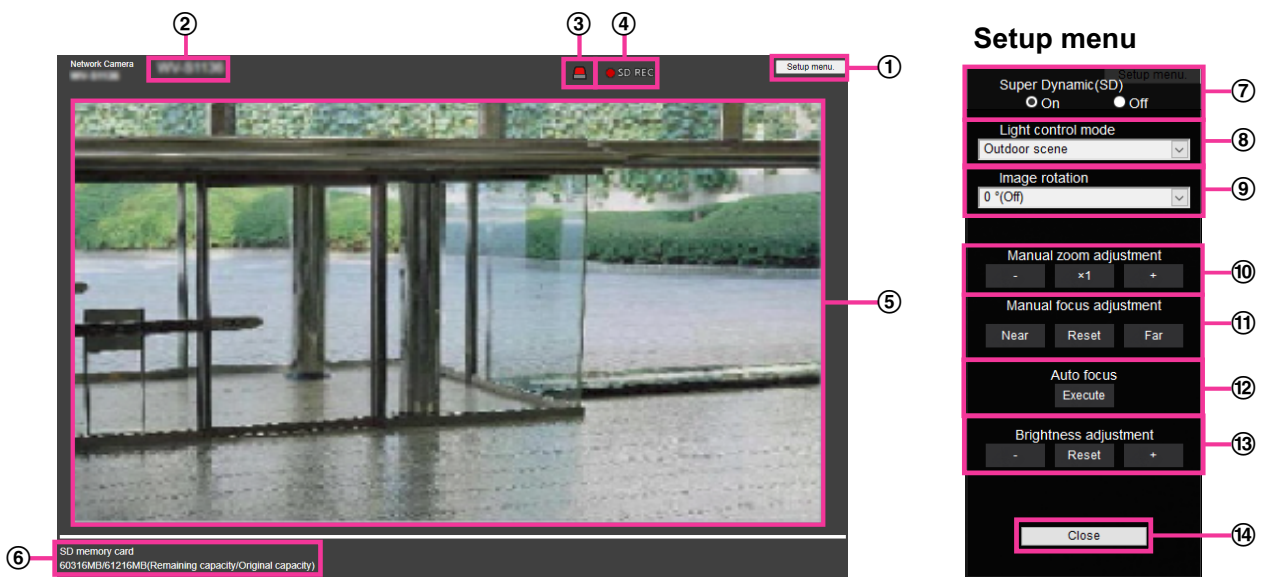

- ① **[Setup menu] button**<sup>1</sup>  
Displays the setup menu.
- ② **Camera title**  
The camera title entered for “Camera title” on the [Basic] tab will be displayed. (→“3.5.1 Configure the basic settings [Basic]”)
- ③ **Alarm occurrence notification button**<sup>2</sup>  
When an alarm occurs, the display flashes. When this button is clicked, this button will disappear. (→“1.4 Action at an alarm occurrence”)



**Note**

- Since the blinking of the alarm occurrence indication button is not coupled to recording images to the SD memory card, forwarding E-mails, or other operations, check the settings of each operation separately.

**④ SD recording status indicator**

The status of the SD recording can be checked with this indicator. When the SD recording starts, the SD recording status indicator will light red. It will go off when the SD recording stops.

This indicator will be displayed when “Manual” or “Schedule” is selected for “Save trigger” on the setup menu. (→“3.5.2 Configure the settings relating to the SD memory card [SD memory card]”)

**⑤ Main area**

The live images from the camera will be displayed in this area.

**⑥ Remaining capacity**

Displays the remaining capacity and total capacity of the SD memory card.

**⑦ Super Dynamic setting**

Select “On” or “Off” to determine whether or not to activate the super dynamic function. This is not available when “Image capture mode” is set to “16:9 mode(60fps mode)” or “16:9 mode(50fps mode)”. Refer to the description “Super Dynamic function” about the super dynamic function.

**On:** The super dynamic function will work.

**Off:** The super dynamic function will not work.

**Default:** Off

**Note**

- When the following are observed depending on the light condition, select “Off” for “Super Dynamic(SD)”.
  - When flickering appears or the color changes on the screen
  - When noise appears in the brighter area on the screen
- When [Light control mode] is set to “Fix shutter”, [Super Dynamic] cannot be set to “On”.
- When “On” is selected for “Stabilizer”, “Off” will automatically be set for “Super Dynamic(SD)”.

**⑧ [Light control mode] pull-down menu**

Select the light control mode from the following.

**Outdoor scene:** Depending on the brightness level (illuminance), the iris will automatically be controlled together with the shutter speed adjustment to control light. When shooting a bright subject such as outdoor, etc., select this parameter. Be aware that flicker may occur when a subject is under fluorescent lighting.

**Indoor scene (50 Hz) / Indoor scene (60 Hz):** The shutter speed will automatically be adjusted to prevent flicker caused by fluorescent light. Select 50 Hz or 60 Hz corresponding to the location where the camera is in use.

**Fix shutter:**

- When 30fps mode or 15fps mode is selected for [Image capture mode]:  
1/30 Fix, 3/120 Fix, 2/100 Fix, 2/120 Fix, 1/100 Fix, 1/120 Fix, 1/250 Fix, 1/500 Fix, 1/1000 Fix, 1/2000 Fix, 1/4000 Fix, 1/10000 Fix
- When 25fps mode or 12.5fps mode is selected for [Image capture mode]:  
1/25 Fix, 3/100 Fix, 2/100 Fix, 1/100 Fix, 1/250 Fix, 1/500 Fix, 1/1000 Fix, 1/2000 Fix, 1/4000 Fix, 1/10000 Fix
- When 60fps mode is selected for [Image capture mode]:  
1/60 Fix, 1/100 Fix, 1/120 Fix, 1/250 Fix, 1/500 Fix, 1/1000 Fix, 1/2000 Fix, 1/4000 Fix, 1/10000 Fix
- When 50fps mode is selected for [Image capture mode]:  
1/50 Fix, 1/100 Fix, 1/250 Fix, 1/500 Fix, 1/1000 Fix, 1/2000 Fix, 1/4000 Fix, 1/10000 Fix

**Default:** Outdoor scene

**Note**

- When a faster shutter speed is selected (up to 1/10000), it is possible to capture a fast moving object with less blur.

- When a faster shutter speed is selected, the sensitivity will become lower.
- When “On” is selected for “Super Dynamic(SD)”, “Fix shutter” is not available. To configure “Fix shutter”, set “Super Dynamic(SD)” to “Off”.
- When 25fps, 50fps, or 12.5fps mode is selected for “Image capture mode”, “Indoor scene (60 Hz)” is not available.

### ⑨ [Preset position setting] button

Set the preset positions.

Move the camera to the desired direction to be registered before registering the preset.

When changing the direction of the camera, click a point to be set as the center of the angle of view after enabling [Swipe operation permission].

The camera direction will be shifted while setting the clicked point as the center of the angle of view.

When zooming in, perform selection operation so as to enclose an area on the image to be zoomed in after enabling [Swipe operation permission].

### **IMPORTANT**

- Please beware of the following when performing the preset position registration using a tablet.
  - When the refresh rate of images on the tablet is slow, it is recommended to perform the preset registration setting while monitoring images on the check monitor.
  - When the screen is resized by operating the tablet, operation for direction change using the screen and operation for zoom in may sometimes not work.
  - When the camera direction cannot be adjusted by operating the tablet, shift the camera toward a desired direction to be registered referring to “1.2.1 Monitor images on a mobile terminal (smartphone, etc.)”.

### **[Preset No]**

Set a position number to be registered.

### **[Preset ID]**

Select “On” or “Off” to determine whether to display the preset ID.

This function can be applied to each preset position.

**On:** Displays the preset ID.

**Off:** Does not display the preset ID.

**Default:** Off

### **IMPORTANT**

- When “Preset ID (0-9,A-Z)” or “Preset ID” is configured, it is necessary to click the [Set] button to apply them.

### **Note**

- When “On” is selected, the entered preset ID will be displayed at the position selected for “Position of camera title on screen” on the [Basic] tab of the “Basic” page. (→[OSD] - [Position of camera title on screen])

### **[Preset ID]**

Enter an preset ID to be displayed on the screen. This function can be applied to each preset position.

**Available number of characters:** 0 - 40 characters

**Available characters:** 0-9, A-Z, a-z and the following marks.

! " # \$ % & ' ( ) \* + , - . / : ; = ?

**Default:** None (blank)

**Note**

- The entered preset ID will be displayed next to the preset position number on the pull-down menu. When “On” is selected for “Preset ID”, the preset ID will be displayed on images as well.

**⑩ [Auto focus]**

Select “Auto” or “Off” to determine whether to enable or disable the auto focus function after the camera has moved to a preset position. This function can be applied to each preset position.

**Auto:** The auto focus function will be activated after moving to a preset position.

**Off:** Does not activate the auto focus function after moving to a preset position.

**Default:** Off

**Note**

- When the preset position is set to shoot the following objects, it is recommended to select “Off”, and adjust the focus before registering the preset positions.
  - An object whose depth never changes
  - An object whose contrast is low
  - An object with high luminance such as a spotlight

**[Dwell time]**

Select a dwell time (duration the camera stops for at each preset position) for the preset sequence operation.

5s/ 10s/ 15s/ 20s/ 25s/ 30s

**Default:** 10s

**Note**

- For the preset positions that are set to “Off”, the preset sequence will move to the next preset position without moving to its preset position.
- Depending on the set dwell time, moving to the next preset position may start during auto focus operation.
- Using the preset sequence function for a long period of time wears the driving parts, and the replacement interval of those parts may be shortened. Refer to the Basic Information for the consumable parts.

**⑪ [Zoom]**

The zoom can be adjusted manually.

 : Click this button to adjust the zoom ratio to the “Wide” side until x1.0.

 : Click this button to set the zoom ratio to x1.0.

 : Click this button to adjust the zoom ratio to the “Tele” side.

**⑫ [Focus]**

The zoom can be adjusted manually.

 : Click this button to adjust the focus automatically.

 : Click this button to adjust the focus to the “Near” side.

 : Click this button to adjust the focus to the “Far” side.

**Note**

- When shooting the following place or the following subjects, focus may not be adjusted automatically. Adjust the focus manually.
  - Shiny or strongly reflective subject
  - Subject through the glass with dew or smudge
  - Two subjects whose distances from the camera are different
  - Less contrast subject (e.g. white wall)
  - Horizontal-striped subject such as a window blind

- Inclined subject
- Dark subjects

⑬ **[Brightness adjustment] button**

Adjust the brightness.

Click the [+] button to make the image brighter.

Click the [-] button to make the image darker.

Click the [Reset] button to reset to the default brightness setting.

⑭ **[Close] button**

Close the setup menu.

### Note

- When the HTTP port number is changed from “80”, enter “http://IP address: (colon) + port number”<sup>3</sup> in the address box of the browser. When using the DDNS function, access to “http://Host name registered in the DDNS server: (colon) + port number”<sup>3</sup>.
- When “HTTPS” is selected for “HTTPS” - “Connection” on the [Advanced] tab of the “Network” page, enter as follows.  
“https://IP address: (colon) + port number” or “https://Host name registered in the DDNS server: (colon) + port number”<sup>3</sup>
- When the authentication window is displayed, enter the user name of an administrator or user and password. Depending on the mobile terminal in use, password entry may be required each time the screen is switched.
- Depending on the tablet device in use, larger size images may not be displayed. In this case, selecting a setting close to the lowest quality setting for “Image quality setting” of “JPEG” (→“3.6.2 Configure the settings relating to JPEG images [Image]”) may sometimes solve this problem.
- Depending on the tablet device in use or its contract plan, it may be impossible to access.

---

<sup>1</sup> Only operable by users whose access level is “1. Administrator”.

<sup>2</sup> Only operable by users whose access level is “1. Administrator” or “2. Camera control” when “On” is selected for “User auth.” (→[User auth.])

<sup>3</sup> Only when accessing the camera via the Internet.

## 1.3 Record images on the SD memory card manually

Images displayed on the “Live” page can be recorded on the SD memory card manually. This button is operable only when “Manual” is selected for “Save trigger” on the [SD memory card] tab on the “Basic” page of the setup menu. (→[Save trigger])

It is possible to select “JPEG(1)”, “JPEG(2)”, “Stream(1)”, “Stream(2)”, “Stream(3)”, or “Stream(4)” on “Recording format” of the setup menu. (→“Recording stream”) When “JPEG(1)” or “JPEG(2)” is selected for “Recording format”, still image data are recorded. When “Stream(1)”, “Stream(2)”, “Stream(3)”, or “Stream(4)” is selected, video data are recorded.

1. Display the “Live” page. (→“1.1.1 Monitor images from a single camera”)
2. Display the camera control panel by clicking the camera control panel display button.
3. Click the [Start] button to start recording images on the SD memory card. The SD recording status indicator will light red (→“1.1.2 About the “Live” page”) while images are being recorded on the SD memory card. The image saving interval can be configured on the [SD memory card] tab of the “Basic” page. (→“3.5.2 Configure the settings relating to the SD memory card [SD memory card]”)
4. Click the [Stop] button to stop saving images on the SD memory card.  
→ The SD recording status indicator will turn off.
5. Close the camera control panel by clicking the camera control panel display button.

### **Note**

- Image data saved in the SD memory card can be downloaded to the PC via the log list window by clicking the [Start] button in [Log/Play] on the “Live” page. Image data can be saved in the PC using the download function. (→“1.6.1 Playback “JPEG(1)”/“JPEG(2)” images saved to the SD memory card”)  
The destination to save image data is a fixed directory on the SD memory card. (→“4.3 Directory structure of SD memory card”)
- When the [Start] button is clicked immediately after the [Stop] button is clicked, saving of images may not start. In this case, click the [Start] button again.
- In order to be able to correctly use this function, format the SD memory card with the camera before using it.

## 1.4 Action at an alarm occurrence

The alarm action (camera action at an alarm occurrence) will be performed when the following alarms occur.

### 1.4.1 Alarm type

- **Terminal alarm:** When connecting an alarm device such as a sensor to the alarm input terminal of the camera, the alarm action will be performed when the connected alarm device is activated.
- **VMD alarm:** When motion is detected in the set VMD area, the alarm action will be performed.  
\*VMD stands for “Video Motion Detection”.
- **SCD alarm:** This function triggers an alarm action when observed a change in the state of a subject such as by covering the camera with a cloth, a cap or others, or by changing the camera direction largely.
- **Command alarm:** When a TCP alarm notification is received from the connected device via a network, the alarm action will be performed.
- **Audio detection alarm:** When the configured audio detection level is exceeded, the alarm action will be performed.
- **Alarm notification from the extension software** **S613xx** **S653xx**: In case that the extension software having an alarm function is installed, an alarm action will be taken when an alarm is issued by the alarm function of the extension software.

### 1.4.2 Action at an alarm occurrence

#### Display the alarm occurrence indication on the “Live” page

The alarm occurrence indication will be displayed on the “Live” page at an alarm occurrence. (→“1.1.2 About the “Live” page”)

#### Notify of alarm occurrences to the device connected to the output terminal

It is possible to output signals from the output terminal of the camera and sound the buzzer when an alarm occurs. The settings for the alarm output can be configured in the [Alarm] tab of the “Alarm” page. (→“3.9.2 Configure the settings relating to the output terminal [Alarm]”)

#### Save images on the SD memory card

When an alarm occurs, images (JPEG/H.265/H.264) will be saved on the SD memory card. The settings to save images on the SD memory card can be configured on the [SD memory card] tab (→“3.5.2 Configure the settings relating to the SD memory card [SD memory card]”) of the “Basic” page and the [Alarm] tab of the “Alarm” page. (→“3.9.4 Configure the settings relating to the camera action on alarm occurrence [Alarm]”)

#### Notify of alarm occurrences by E-mail

Alarm E-mail (alarm occurrence notification) can be sent at an alarm occurrence to the E-mail addresses registered in advance. Up to 4 addresses can be registered as recipients of the alarm E-mail. An alarm image (still picture) can be sent with the alarm E-mail as an attached file. The settings for alarm E-mail can be configured in the “Alarm E-mail notification” section on the [Alarm] tab of the “Alarm” page (→“3.9.4 Configure the settings relating to the camera action on alarm occurrence [Alarm]”) and the [Advanced] tab of the “Network” page. (→“3.11.2.1 Configure the settings related to sending E-mails”)

## Notify of alarm occurrences to the designated addresses (TCP alarm notification)

This function is available only when our device, such as the network disk recorder, is connected to the system. When “On” is selected for “TCP alarm notification”, the connected our device will be notified that the camera is in the alarm state. The settings for TCP alarm notification can be configured in the “TCP alarm notification” section of the [Notification] tab of the “Alarm” page. (→3.9.10.1 Configure the settings relating to TCP alarm notification)

## Notify of alarm occurrences to the designated HTTP server (HTTP alarm notification)

Alarm occurrence notifications can be sent at an alarm occurrence to the HTTP servers registered in advance. Up to 5 HTTP servers can be registered as recipients of alarm notifications. The URL sent to HTTP servers with alarm notifications can be specified. The settings for HTTP alarm notification can be configured on the [Notification] tab of the “Alarm” page. (→“3.9.10.2 Configure the settings relating to HTTP alarm notification”)

## Transmit an image onto a server automatically

An alarm image can be transmitted at an alarm occurrence to the server designated in advance. The settings required to transmit an alarm image to a server can be configured in the [Alarm] tab of the “Alarm” page (→“3.9.4.3 Configure settings relating to FTP/SFTP transmissions of alarm images”) and the [Advanced] tab of the “Network” page (→“3.11.2.2 Add FTP/SFTP image transmission function”)

## 1.5 Display the log list

The history of various logs will be displayed in list form.

- **Alarm log:** Logs of the alarm occurrences such as time and date of the alarm occurrences, the image recording period and the alarm type will be displayed.
- **Manual/Schedule log:** Logs filed when images have been recorded manually or during the period of the schedule, and the image recording period will be displayed.
- **FTP/SFTP trans. error log:** Logs filed when the FTP/SFTP periodic image transmission function has failed will be displayed.

1. Display the “Live” page. (→“1.1.1 Monitor images from a single camera”)
2. Display the camera control panel by clicking the camera control panel display button.
3. Click the [Start] button of [SD memory card - Log/Play].  
→ The log list will be displayed in a newly opened window (log list window).

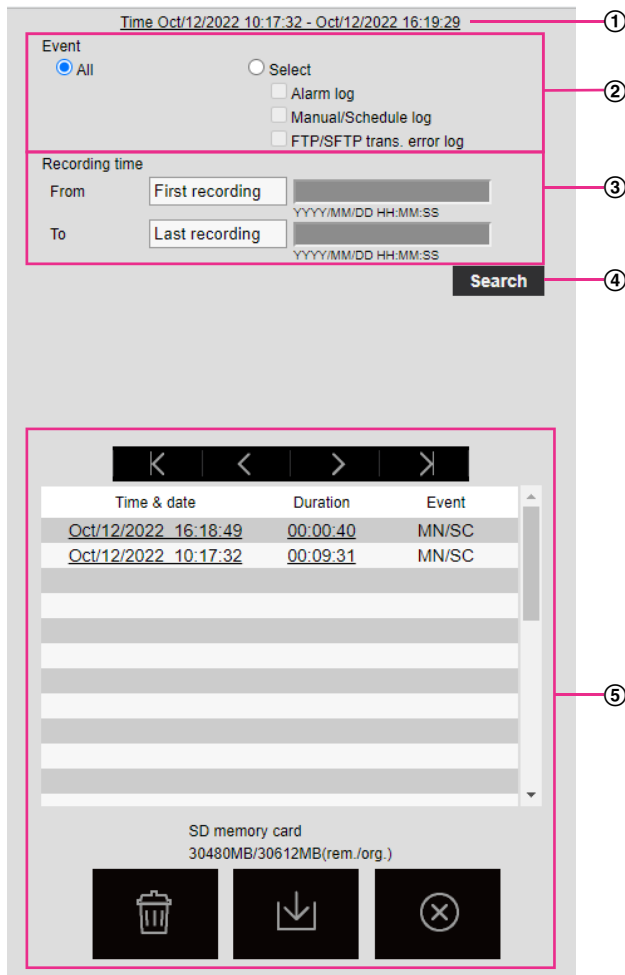

### IMPORTANT

- Only a single user can operate the log list window. Other users cannot access the log list window.

- ① **Time**  
Displays the time period of the data recorded on the SD memory card.



② **Event**

Select a log type to display on the log list.

- **All:** All logs will be displayed.
- **Select:** Only the logs of the selected log type will be displayed.
  - **Alarm log:** The log when an alarm is detected will be displayed.
  - **Manual/Schedule log:** Manual and Schedule logs will be displayed.
  - **FTP/SFTP trans. error log:** Logs filed when the FTP/SFTP periodic image transmission function has failed will be displayed.
- **Default:** All

③ **Recording time**

Configure the time period of logs displayed on the log list.

- **From:** Configure the starting period of logs displayed on the log list.
  - **First recording:** Displays from the first log recorded on the SD memory card.
  - **Today:** Displays the logs recorded today.
  - **Yesterday:** Displays the logs recorded from yesterday to the present day.
  - **Last 7 days:** Displays the logs recorded from 6 days ago to the present day.
  - **Last 30 days:** Displays the logs recorded from 29 days ago to the present day.
  - **Date/time:** Displays the logs recorded from the entered date and time on “Date/time” box.
- **To:** Configure the ending period of logs displayed on the log list when “First recording” or “Date/time” is selected for “From”.
  - **Last recording:** Displays until the last log recorded on the SD memory card.
  - **Date/time:** Displays the logs recorded until the entered date and time on “Date/time” box.





④ **[Search] button**

Searches for logs according to the conditions specified in “Event” and “Recording time”. The search result will be displayed on the log list.

⑤ **Log list**

Displays the log search results.



You can play back recorded data by clicking on the time or duration of the recorded data displayed under [Time & date] and [Duration].

-  **(Top) button:** Click this button to display the log listed at the top.
-  **(Prev. page) button:** Click this button to display the previous page of the log list.
-  **(Next page) button:** Click this button to display the next page of the log list.
-  **(Last) button:** Click this button to display the log listed at the bottom.
- **[Time & date]:** Time and date when each log has been recorded will be displayed.



**Note**

- When “24h” is selected for “Time display format”, the alarm occurrence times are displayed in 24 hour time format.
- The recording timing of logs is as follows.
  - **Alarm log:** Alarm occurrence time and date will be filed as a log.
  - **Manual/Schedule log:** Time and date when recording of images onto the SD memory card started manually or during the period of the schedule will be filed as a log. When images are recorded sequentially, if “JPEG” is selected for “Recording format”, logs will be filed on the hour every hour (12:00, 1:00, 2:00, etc.). If “Stream” is selected for “Recording format”, logs will be filed every hour from the time when recording starts.
  - **FTP/SFTP trans. error log:** Logs will be filed every one hour.
- **[Duration]:** Displays the period of time that the data has been recorded on the SD memory card.

### Note

- The difference between the recording end time and recording start time of the image is calculated by rounding off to the nearest tenth of a second. For this reason, when only 1 JPEG image is saved, 00:00:00 is displayed for the duration.
- **[Event]:** The event type will be displayed.
  - **MN/SC:** Log by “Manual/Schedule”
  - **TRM1:** Alarm by alarm input to Terminal 1
  - **TRM2:** Alarm by alarm input to Terminal 2
  - **TRM3:** Alarm by alarm input to Terminal 3
  - **VMD:** Alarm by VMD alarm
  - **SCD:** Alarm by SCD alarm
  - **COM:** Alarm by command alarm
  - **AT**  : Alarm detected by auto track alarm
  - **INT:** Intruder Alarm by AI-VMD
  - **LOI:** Loitering Alarm by AI-VMD
  - **DIR:** Direction Alarm by AI-VMD
  - **CLD:** Cross Line Alarm by AI-VMD
  - **FTP/SFTP:** Logs saved from FTP/SFTP periodic image transmission errors
- **[SD memory card]:** Available capacity and the original capacity of the SD memory card will be displayed.
-  **(Delete) button:** Deletes log lists from all pages. When logs are searched for, only the searched logs are deleted. Images associated with deleted logs will also be deleted.

### IMPORTANT

- If there are many recorded data files on the SD memory card, it may take time to delete all of them. In this case, format the SD memory card. However, please note that formatting will delete all of the files on the SD memory card.
- In the process of the deletion, “Alarm” and “Manual/Schedule” cannot be operated.
- Do not turn off the power of the camera until the deletion is complete. When the power of the camera is turned off in the process of the deletion, some images may remain on the SD memory card. In this case, click the  button on the same log list window used to delete the logs.
-  **(Download) button:** Click this button to download all logs of the selected log list onto the PC.

### Note

- Up to 50,000 logs will be downloaded to the SD memory card. When more than 50,000 logs are filed, the older logs will be overwritten by the newer logs. In this case, the oldest log is the first to be overwritten.  
If there are many logs, it may take time to download the logs.
-  **(Close) button:** Click this button to close the log list window.

## 1.6 Playback of images on the SD memory card

When clicking a time and date listed on the log list window, the “Live” page will turn to the “Playback” page. When images associated with the clicked time and date are on the SD memory card, the first image of them will be displayed.

### IMPORTANT

- Refresh interval of images may become slow during playback or download.
- When many images are saved on the SD memory card, it may take time to display images on the “Playback” page.
- Images will be displayed in “640×360” on the “Playback” page regardless of the image capture size of the images saved on the SD memory card. Therefore, images may look coarse on the “Playback” page.
- When playing images by selecting an FTP error log on the log list, images may not be played in order of images recorded on the SD memory card if they have been recorded on the SD memory card with selected value for the “Transmission interval” setting of “Periodic image transmission” on the [Advanced] tab is “1min” or less.
- The playback refresh interval may become slower when recording data to the SD memory card.
- When playing H.265 images recorded at a high recording bit rate, only the I-frames may be displayed.

### 1.6.1 Playback “JPEG(1)”/“JPEG(2)” images saved to the SD memory card

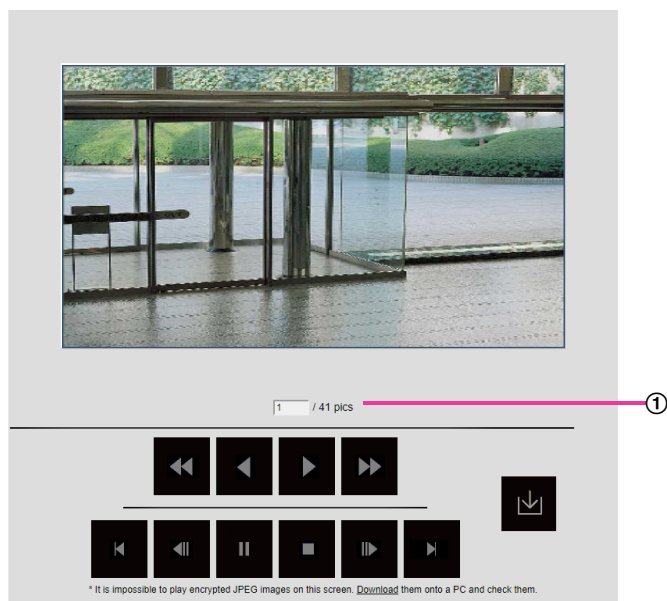

When images associated with the clicked time and date are on the SD memory card, the first image of them will be displayed.

#### ① Number of images



When clicking a time and date listed on the log list window, total number of images associated with the clicked time and date, and the number of the currently displayed image will be displayed.

### Note

- Enter the desired number of image and press the [Enter] key on the keyboard. The image of the designated number will be displayed.

### (REW) button

Each time the button is clicked, the playback speed will change.

When the  button or the  button is clicked during fast reverse playback, playback speed will return to the normal playback speed.

### (REV PLAY) button



Images will be played in reverse sequential order.

### (PLAY) button

When this button is clicked, images will be played in sequential order.

### (FF) button

Each time the button is clicked, the playback speed will change.

When the  button or the  button is clicked during fast playback, playback speed will return to the normal playback speed.

### (TOP) button

The first image will be displayed.

### (PREV. IMAGE) button

The previous frame will be displayed and paused when this button is clicked during playback.

Each time this button is clicked during pausing, the frame previous to the currently displayed frame will be displayed.

### Note

- When the mouse button is held down while the mouse pointer is on this button, the image number will be decreased.  
When the mouse button is released, the decreasing of the image number will stop and the image corresponding to the currently displayed number will be displayed.

### (PAUSE) button

Playback will be paused when this button is clicked during playback.

Playback will resume when this button is clicked during pausing.

### (STOP) button

Playback will stop and the “Playback” window will turn to the “Live” page.

### (NEXT IMAGE) button

The next frame will be displayed and paused when this button is clicked during playback.

Each time this button is clicked during pausing, the frame next to the currently displayed frame will be displayed.

**Note**

- When the mouse button is held down while the mouse pointer is on this button, the image number will be increased.  
When the mouse button is released, the increment of the image number will stop and the image number displayed at the moment when the mouse button is released will be displayed.

** (LAST) button**

The last image will be displayed.

** (Download) button**

The selected image will be downloaded onto the PC.

For the destination directory on the PC, check the setting of the browser being used.

The message window will be displayed to ask if it is OK to start download when the  button is clicked. Click the [OK] button.

**Note**

- The image playing screen cannot be operated while downloading. Perform operations after the downloading is completed.
- When the [Cancel] button is clicked in the process of the download, the download will be canceled. In this case, video data already downloaded before clicking the [Cancel] button will be saved on the PC.
- Video data are saved in the files of approx. 60 MB. When the file size of video data is more than 60 MB, two or more files will be downloaded.
- It is possible to play back H.264 video data saved on the PC using such applications as Windows Media® Player. However, we are not liable for performance relating to these applications.
- Depending on the status of the SD memory card or Windows Media Player, H.264 video data cannot be played back.
- For information on H.265 video playback, refer to our technical information website <Control No.: C0303>.

## 1.6.2 Playback “Stream(1)”/“Stream(2)”/“Stream(3)”/“Stream(4)” images saved to the SD memory card

### IMPORTANT

- Depending on the network environment, download of video data may fail. If downloading failed while playing images, you may be able to download images after stopping the currently played images and starting the download again.
- Depending on the network environment and status of the camera, you may not be able to operate each operation on this screen consecutively.

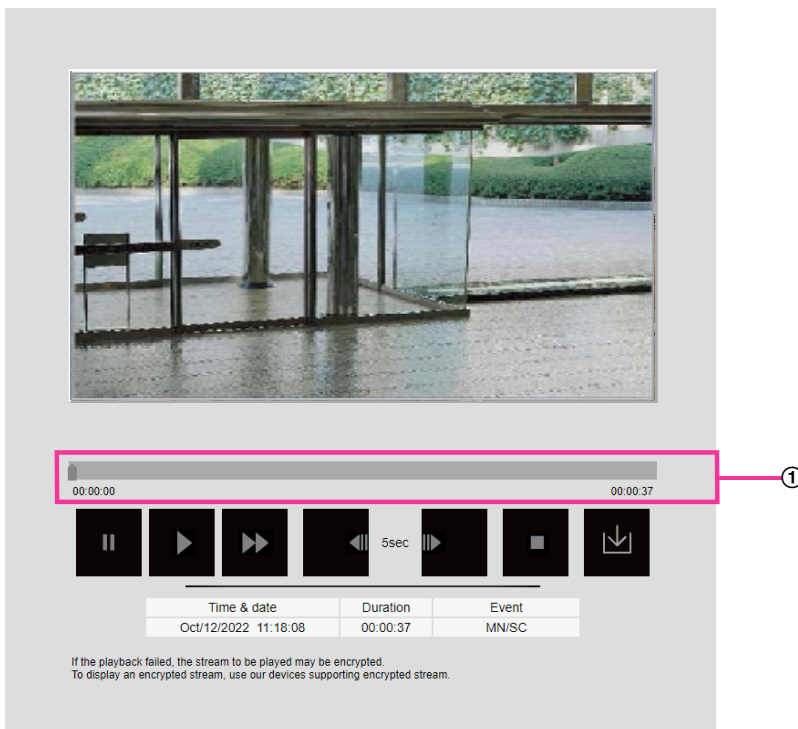

Images can be played by pressing the PLAY button after the image playing screen is displayed.

#### ① Slider bar

By operating the slider bar, you can select where to start playing images from. The slider bar can only be used before playing images, or when playing is paused or stopped.

#### Note

- When the slide bar is moved to a certain point, the i-frame corresponding to this point will be designated. Therefore, when a stream is being recorded in a state where “Advanced(Fixed GOP 60s w/1s key-frame)” is selected for “GOP control”, positions where the slide bar can be moved to will be in steps of 60 seconds.

#### ⏸ (PAUSE) button

Playback will be paused when this button is clicked during playback.

#### ▶ (PLAY) button

When this button is clicked, recorded data will be played.

**Note**

- If audio is recorded, it can be played back, but the image and audio will not be synchronized. Therefore, images and audio may not always match. When data is being recorded to the SD memory card, audio may sound as if it is cutting out and the audio quality may be reduced.
- When recorded audio is played back, the refresh interval of live images and playback may become slow.
- Recorded audio is not played back when “Off” or “Interactive(Half-duplex)” is selected for “Audio transmission mode” on the [Audio] tab of the “Image/Audio” page.

 **(FF) button**

Each time this button is clicked, the playback speed will change. When the  button is clicked during fast playback, playback speed will return to the normal playback speed.

**Note**

- The maximum speed of the fast playback varies depending on the setting of “Bit rate” - “Stream recording” of the SD memory card.
- Recorded audio will not be played back during fast playback.
- Displaying of images may become slower or the playback time may skip during the fast playback depending on the setting of “Bit rate” - “Stream recording”.

 **(5s backward) button**

Each time this button is clicked, the recorded data goes back by 5 seconds and starts playing.

**Note**

- When a stream is being recorded in a state where “Advanced(Fixed GOP 60s w/1s key-frame)” is selected for “GOP control”, clicking this button may skip back more than 5 seconds depending on the time when the corresponding i-frame is recorded.

 **(5s forward) button**

Each time this button is clicked, the recorded data goes forward by 5 seconds and starts playing.

**Note**

- When a stream is being recorded in a state where “Advanced(Fixed GOP 60s w/1s key-frame)” is selected for “GOP control”, clicking this button may skip back instead of forward depending on the time when the corresponding i-frame is recorded.

 **(STOP) button**

Playback will stop and the “Playback” window will turn to the “Live” page.

**[Time & date]**

Time and date when each log has been recorded will be displayed.

**[Duration]**

Displays the period of time that the data has been recorded on the SD memory card.

**[Event]**

The event type will be displayed.

- **MN/SC:** Log by “Manual/Schedule”
- **TRM1:** Alarm by alarm input to Terminal 1
- **TRM2:** Alarm by alarm input to Terminal 2

- **TRM3:** Alarm by alarm input to Terminal 3
- **VMD:** Alarm by VMD alarm
- **SCD:** Alarm by SCD alarm
- **COM:** Alarm by command alarm
- **AT** **S613xx** **S653xx**: Alarm detected by auto track alarm
- **INT:** Intruder Alarm by AI-VMD
- **LOI:** Loitering Alarm by AI-VMD
- **DIR:** Direction Alarm by AI-VMD
- **CLD:** Cross Line Alarm by AI-VMD

### (Download) button

The selected image will be downloaded onto the PC.

For the destination directory on the PC, check the setting of the browser being used.

The message window will be displayed to ask if it is OK to start download when the  button is clicked. Click the [OK] button.

### **Note**

- The image playing screen cannot be operated while downloading. Perform operations after the downloading is completed.
- When the [Cancel] button is clicked in the process of the download, the download will be canceled. In this case, video data already downloaded before clicking the [Cancel] button will be saved on the PC.
- Video data are saved in the files of approx. 60 MB. When the file size of video data is more than 60 MB, two or more files will be downloaded.
- It is possible to play back H.264 video data saved on the PC using such applications as Windows Media® Player. However, we are not liable for performance relating to these applications.
- Depending on the status of the SD memory card or Windows Media Player, H.264 video data cannot be played back.
- For information on playing back H.265 video data, refer to our technical information website <Control No.: C0303>.



## 2 Settings

### 2.1 Display the settings panel from a PC

The major settings of the camera can be configured on the settings panel.

#### IMPORTANT

- The settings panel is operable only by users whose access level is “1. Administrator”. Refer to “3.10.1 Configure the settings relating to the user authentication [User auth.]” for how to configure the access level.

#### 2.1.1 How to display the settings panel

- Display the “Live” page. (→“1.1.1 Monitor images from a single camera”)
- Click the  button on the “Live” page.
  - The settings panel will be displayed. When the button is clicked once again, the settings panel will be hidden.
  - Refer to “2.1.3 About the settings panel” for further information about this panel.

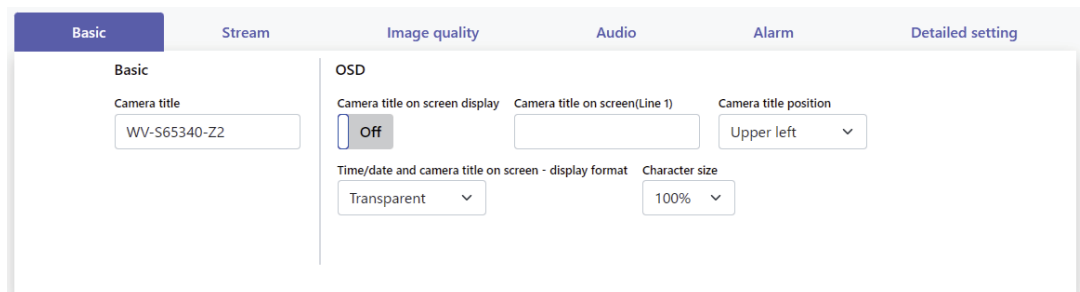

#### 2.1.2 How to operate the setup menu

- Click each tab of the settings panel.



- Complete each setting item displayed in the frame on the right of the window.

#### Note

- Some items may be unavailable depending on the content displayed in the main area. When the desired item to be set is not displayed, click   or operate the scroll bar until it is displayed and then edit the setting of the item.

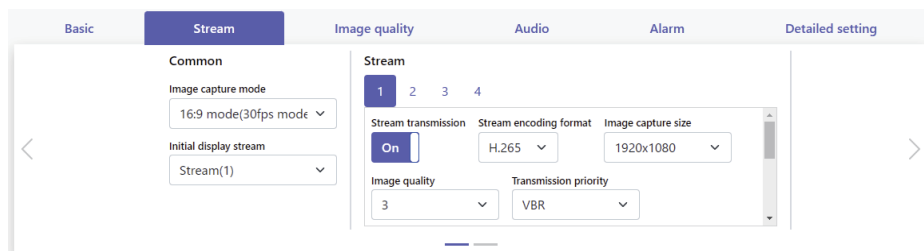

## 2 Settings

---

3. After completing the setting of the item, click the [Set] button to determine the edited setting when the item has the button. When the item does not have the [Set] button, the setting value will be determined when it is selected.

### **IMPORTANT**

- When there are two or more [Set], [Register], and [Execute] buttons on the page, click the respective button to the edited setting item.

## 2.1.3 About the settings panel

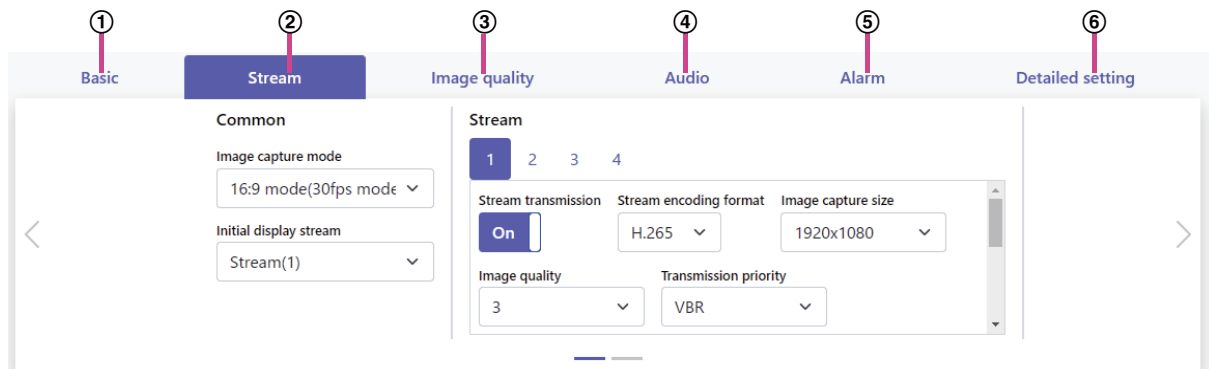

- ① **[Basic] tab**  
Displays the [Basic] tab. On the [Basic] tab, the camera title, character display and related items can be configured. (→“2.2 Configure the basic settings [Basic]”)
- ② **[Stream] tab**  
Displays the [Stream] tab. On the [Stream] tab, the image capture mode, JPEG, stream and related items can be configured. (→“2.3 Configure the settings relating to images [Stream]”)
- ③ **[Image quality] tab**  
Displays the [Image quality] tab. On the [Image quality] tab, the image quality and related items can be configured. (→“2.4 Configure the settings relating to image quality [Image quality]”)
- ④ **[Audio] tab**  
Displays the [Audio] tab. On the [Audio] tab, the audio, alarm and related items can be configured. (→“2.5 Configure the settings relating to audio [Audio]”)
- ⑤ **[Alarm] tab**  
Displays the [Alarm] tab. On the [Alarm] tab, the settings relating to alarm can be configured. (→“2.6 Configure the settings relating to the alarm [Alarm]”)
- ⑥ **[Detailed setting] tab**  
Displays the [Detailed setting] tab. On the [Detailed setting] tab, shifting to the detailed setting and the operation panel setting can be configured. (→“2.7 Shift to the detailed setting and configure the settings relating to screen display [Detailed setting]”)

## 2.2 Configure the basic settings [Basic]

On the [Basic] tab, the camera title and items related to screen display can be configured. Check the [Basic] tab of the "Basic" page of the detailed setting menu for detailed explanation about the setting value and cautions at the time of setting. (→"3.5 Configure the basic settings of the camera [Basic]")

### [Camera title]

Enter the title of the camera. Click the [Set] button after entering the title of the camera. The entered title will be displayed in the "Camera title" field.

- **Available number of characters:** 0 - 20 characters
- **Unavailable characters:** " &

**Default:** The model No. is displayed.

### [Upside-down] S653xx U653xx <WV-S61302-Z4> <WV-U61300-ZY> <WV-S65501-Z1>

Select "On" or "Off" to determine whether or not to turn the image upside-down.

**Default:** Off

### [Upside-down] <WV-S61301-Z2> <WV-S61301-Z1> <WV-U61301-Z2> <WV-U61301-Z1> <WV-S61501-Z1>

Select "On (desktop)" or "Off (ceiling)" in accordance with the installation method of the camera.

**Default:** Off (ceiling)

### [OSD] - [Camera title on screen display]

Select "On" or "Off" to determine whether or not to display the camera title on the screen.

When "On" is selected, the character string entered for "Camera title on screen" will be displayed at the position selected for "Camera title position".

**Default:** Off

### [OSD] - [Camera title on screen(Line 1)]

Enter a character string to be displayed on the image.

- **Available number of characters:** 0 - 40 characters
- **Available characters:** 0-9, A-Z, a-z and the following marks.  
! " # \$ % & ' ( ) \* + , - . / : ; = ?
- **Default:** None (blank)

### [OSD] - [Position of camera title on screen]

Select the position where the character string will be displayed on the image.

Upper left/ Lower left/ Upper center/ Lower center/ Upper right/ Lower right

**Default:** Upper left

### [OSD] - [Time/date and camera title on screen - display format]

Select "Transparent" or "Opaque" for "Display style".

**Default:** Transparent

### [OSD] - [Character size]

Select the character size of the date and time as well as text displayed in the image.

50%/ 75%/ 100%/ 150%/ 200%

**Default:** 100%

## 2.3 Configure the settings relating to images [Stream]

On the [Stream] tab, the settings relating to JPEG, H.265, and H.264 images can be configured. Check the [Image] tab of the “Image/Audio” page of the detailed setting menu for detailed explanation about the setting value and cautions at the time of setting. (→“3.6.1 Configure the settings relating to the image capture mode [Image]”, “3.6.2 Configure the settings relating to JPEG images [Image]”, “3.6.3 Configure the settings relating to Stream [Image]”)

### Common

Configure the items common to both JPEG and stream.

#### [Image capture mode]

<WV-S65300 series> <WV-S61300 series> <WV-U65300 series> <WV-U61300 series>  
16:9 mode(30fps mode)/ 16:9 mode(25fps mode)/ 16:9 mode(60fps mode)/ 16:9 mode(50fps mode)/ 4:3 mode(15fps mode)/ 4:3 mode(12.5fps mode)/ 4:3 mode(30fps mode)/ 4:3 mode(25fps mode)  
<WV-S65501-Z1> <WV-S61501-Z1>  
16:9 mode(30fps mode)/ 16:9 mode(25fps mode)/ 4:3 mode(30fps mode)/ 4:3 mode(25fps mode)

- **Default:** 16:9 mode(30fps mode)

#### [Initial display stream]

Select the image to display on the “Live” page from the following.  
JPEG(1)/ JPEG(2)/ Stream(1)/ Stream(2)/ Stream(3)/ Stream(4)/ Multi-screen

- **Default:**  
Stream(1) <WV-S65300 series> <WV-S61300 series> <WV-U65300 series> <WV-U61300 series>  
Stream(2) <WV-S65501-Z1> <WV-S61501-Z1>

### JPEG

Configure the settings of [Image capture size], [Image quality] and [Refresh interval] of JPEG.

#### [Image capture size]

Select the image capture size to display the JPEG image.

- <WV-S65300 series> <WV-S61300 series> <WV-U65300 series> <WV-U61300 series>
- When either of “16:9 mode(30fps mode)”, “16:9 mode(60fps mode)”, “16:9 mode(25fps mode)” or “16:9 mode(50fps mode)” is selected for [Image capture mode]:
    - **JPEG(1):** 1920x1080, 1280x720, 640x360, 320x180
    - **JPEG(2):** 640x360 fixed
    - **Default:** 1920x1080
  - When “4:3 mode(30fps mode)” or “4:3 mode(25fps mode)” is selected for [Image capture mode]:
    - **JPEG(1):** 1280x960, VGA, QVGA
    - **JPEG(2):** VGA fixed
    - **Default:** 1280x960
  - When “4:3 mode(15fps mode)” or “4:3 mode(12.5fps mode)” is selected for [Image capture mode]:
    - **JPEG(1):** 2048x1536, 1280x960, VGA, QVGA
    - **JPEG(2):** VGA fixed
    - **Default:** 2048x1536
- <WV-S65501-Z1> <WV-S61501-Z1>
- **JPEG(1):** Only the same image capture sizes set for “Stream(1)”, “Stream(2)”, “Stream(3)”, “Stream(4)” and “JPEG(2)” are selectable.

- **JPEG(2):** 640x360 fixed (16:9 mode), VGA fixed (4:3 mode)
- **Default:** 2560x1440

### [Image quality]

Select the image quality of JPEG images for each image capture size.

0 Super fine/ 1 Fine/ 2/ 3/ 4/ 5 Normal/ 6/ 7/ 8/ 9 Low

- **Default:** 5 Normal

### [Refresh interval (JPEG)\*]

Select an interval to refresh the displayed JPEG image from the following.

- When either of “16:9 mode(30fps mode)”, “16:9 mode(60fps mode)”, or “4:3 mode(30fps mode)” is selected for [Image capture mode]:  
0.1fps/ 0.2fps/ 0.33fps/ 0.5fps/ 1fps/ 2fps/ 3fps/ 5fps/ 6fps/ 10fps\*/ 12fps\*/ 15fps\*/ 30fps\*
- When either of “16:9 mode(25fps mode)”, “16:9 mode(50fps mode)”, or “4:3 mode(25fps mode)” is selected for [Image capture mode]:  
0.08fps/ 0.17fps/ 0.28fps/ 0.42fps/ 1fps/ 2.1fps/ 3.1fps/ 4.2fps/ 5fps\*/ 8.3fps\*/ 12.5fps\*/ 25fps\*
- When “4:3 mode(15fps mode)” is selected for [Image capture mode]:  
0.1fps/ 0.2fps/ 0.33fps/ 0.5fps/ 1fps/ 2fps/ 3fps/ 5fps/ 6fps/ 10fps\*/ 12fps\*/ 15fps\*
- When “4:3 mode(12.5fps mode)” is selected for [Image capture mode]:  
0.08fps/ 0.17fps/ 0.28fps/ 0.42fps/ 1fps/ 2.1fps/ 3.1fps/ 4.2fps/ 5fps\*/ 8.3fps\*/ 12.5fps\*
- **Default:**  
5fps <WV-S65300 series> <WV-S61300 series> <WV-U65300 series> <WV-U61300 series>  
1fps <WV-S65501-Z1 WV-S61501-Z1>

## Stream

Select a stream number and configure [Stream transmission].

### [Stream transmission]

Select “On” or “Off” to determine whether or not to transmit H.265 (or H.264) images.

**Default:** On

### [Stream encoding format]

Select the stream encoding format for transmission.

**Default:** H.265

### [Image capture size]

Select the image capture size from the following. What can be selected may be limited depending on the image capture size already selected.

<WV-S65300 series> <WV-S61300 series> <WV-U65300 series> <WV-U61300 series>

- When either of “16:9 mode(30fps mode)”, “16:9 mode(60fps mode)”, “16:9 mode(25fps mode)” or “16:9 mode(50fps mode)” is selected for [Image capture mode]:
  - Stream(1): 1920x1080/ 1280x720/ 640x360/ 320x180
  - Stream(2): 1920x1080/ 1280x720/ 640x360/ 320x180
  - Stream(3): 1280x720/ 640x360/ 320x180
  - Stream(4): 640x360/ 320x180
- When “4:3 mode(30fps mode)” or “4:3 mode(25fps mode)” is selected for [Image capture mode]:
  - Stream(1): 1280x960/ VGA/ QVGA
  - Stream(2): 1280x960/ VGA/ QVGA
  - Stream(3): VGA/ QVGA
  - Stream(4): VGA/ QVGA
- When “4:3 mode(15fps mode)” or “4:3 mode(12.5fps mode)” is selected for [Image capture mode]:
  - Stream(1): 2048x1536 fixed

- Stream(2): 1280x960/ VGA/ QVGA
- Stream(3): VGA/ QVGA
- Stream(4): VGA/ QVGA

#### <WV-S65501-Z1> <WV-S61501-Z1>

- When “16:9 mode(30fps mode)” or “16:9 mode(25fps mode)” is selected for [Image capture mode]:
  - Stream(1): 3072x1728/ 2560x1440
  - Stream(2): 3072x1728/ 2560x1440/ 1920x1080/ 1280x720/ 640x360/ 320x180
  - Stream(3): 1280x720/ 640x360/ 320x180
  - Stream(4): 1280x720/ 640x360/ 320x180
- When “4:3 mode(30fps mode)” or “4:3 mode(25fps mode)” is selected for [Image capture mode]:
  - Stream(1): 3072x2304/ 2560x1920
  - Stream(2): 3072x2304/ 2560x1920/ 1280x960/ 800x600/ VGA/ 400x300/ QVGA
  - Stream(3): VGA/ QVGA
  - Stream(4): VGA/ QVGA

#### [Image quality]

Select the image quality of H.265 (or H.264) images from the following.

- For “Constant bit rate”, “Frame rate”, and “Best effort”: Low(Motion priority)/Normal/Fine(Image quality priority)
- VBR: 0 Super fine/ 1 Fine/ 2/ 3/ 4/ 5 Normal/ 6/ 7/ 8/ 9 Low
- Default: 5 Normal

#### [Transmission priority]

Select a transmission priority for “Stream” from the following.

Constant bit rate/ VBR/ Frame rate/ Best effort

**Default:** Frame rate

#### [Frame rate\*]

Select a frame rate from the following.

- When either of “16:9 mode(30fps mode)”, “16:9 mode(60fps mode)”, “4:3 mode(30fps mode)” or “4:3 mode(15fps mode)” is selected for [Image capture mode]:  
1fps/ 3fps/ 5fps\*/ 7.5fps\*/ 10fps\*/ 12fps\*/ 15fps\*/ 20fps\*/ 30fps\*/ 60fps\*
- When either of “16:9 mode(25fps mode)”, “16:9 mode(50fps mode)”, “4:3 mode(25fps mode)” or “4:3 mode(12.5fps mode)” is selected for [Image capture mode]:  
1fps/ 3.1fps/ 4.2fps\*/ 6.25fps\*/ 8.3fps\*/ 12.5fps\*/ 20fps\*/ 25fps\*/ 50fps\*
- **Default:** 30fps\*

#### [Max bit rate (per client)\*]

Select an H.265 (or H.264) bit rate per a client from the following.

64kbps/ 128kbps\*/ 256kbps\*/ 384kbps\*/ 512kbps\*/ 768kbps\*/ 1024kbps\*/ 1536kbps\*/ 2048kbps\*/ 3072kbps\*/ 4096kbps\*/ 6144kbps\*/ 8192kbps\*/ 10240kbps\*/ 12288kbps\*/ 14336kbps\*/ 16384kbps\*/ 20480kbps\*/ 24576kbps\*/--FREE ENTRY--

When “--FREE ENTRY--” is selected, the bit rate can be freely entered in the available range.

- **Default:**
  - Stream(1): 3072kbps\*
  - Stream(2): 2048kbs\*
  - Stream(3): 768kbps\*
  - Stream(4): 768kbps\*

\* The range of bit rates that can be configured for H.265 (or H.264) bit rates differs depending on the “Transmission priority” and “Image capture size”.

When “Constant bit rate”, “Frame rate”, or “Best effort” is selected for “Transmission priority”

## 2 Settings

---

- 320x180, 640x360, QVGA and VGA: 64kbps - 4096kbps\*
- 1280x720 and 1280x960: 128kbps\* - 8192kbps\*
- 1920x1080: 256kbps\* - 12288kbps\*
- 2048x1536: 512kbps\* - 16384kbps\*
- 2560x1440: 768kbps\* - 24576kbps\*
- 2560x1920: 768kbps\* - 24576kbps\*
- 3072x1728: 1024kbps\* - 24576kbps\*
- 3072x2304: 1536kbps\* - 24576kbps\*

When "VBR" is selected for "Transmission priority"

- 320x180, 640x360, QVGA and VGA: 64kbps - 12288kbps\*
- 1280x720, 1280x960: 128kbps\* - 12288kbps\*
- 1920x1080: 256kbps\* - 24576kbps\*
- 2048x1536: 512kbps\* - 24576kbps\*
- 2560x1440: 768kbps\* - 24576kbps\*
- 2560x1920: 768kbps\* - 24576kbps\*
- 3072x1728: 1024kbps\* - 24576kbps\*
- 3072x2304: 1536kbps\* - 24576kbps\*

### [Smart VIQS] **S613xx** **S653xx**

Maintains high image quality in the areas containing heads, people, cars, and motorcycles and low or medium image quality in other areas while reducing the transmission data volume.

Off/ On(High)/ On(Low)

**Default:** Off

### [Auto VIQS] **U613xx** **U653xx**

Maintains high image quality in the areas of the image containing moving objects and reduces the transmission data volume in other areas of the image.

**Default:** Off

### [Smart P-picture control] **S613xx** **S653xx**

Controls the area other than the areas containing heads, people, cars, and motorcycles to be reduced the transmission data volume of P-picture.

**Default:** Off

### [GOP control]

By using "GOP control", the transmission data volume can be reduced.

- **When "H.265" is selected as the "Stream encoding format":** Off/ Low(Variable GOP 1s-8s)/ Mid(Variable GOP 4s-16s)/ Advanced(Fixed GOP 60s w/1s key-frame)/ Frame rate control(Variable GOP 4s-16s w/frame rate control)
- **When "H.264" is selected as the "Stream encoding format":** Off/ Low(Variable GOP 1s-8s)/ Mid(Variable GOP 4s-16s)

**Default:** Off



## 2.4 Configure the settings relating to image quality

### [Image quality]

On the [Image quality] tab, the settings relating to image quality can be configured.

Check the [Image quality] tab of the "Image/Audio" page of the detailed setting menu for detailed explanation about the setting value and cautions at the time of setting. (→"3.6.4 Configure the settings relating to image adjust, privacy zone, and VIQS [Image quality]")

#### [Brightness]

Adjust the brightness.

If you move the slider in the "+" direction, the image will become brighter.

If you move the slider in the "-" direction, the image will become darker.

Click the [Reset] button to reset to the default brightness setting.

- **Default:** 64

#### [Sharpness level]

Adjust the sharpness level (outline compensation).

If you move the slider in the "+" direction, the outline of the image will become sharper, and if you move it in the "-" direction, the outline of the image will become softer. Click the [Reset] button to reset the color to the default.

- **Default:** 16

#### [Maximum gain]

Adjusts the maximum gain. When the luminance of the subject becomes darker, gain will be automatically increased and screen will become brighter. If you increase the gain, the noise may also increase.

If you move the slider in the "+" direction, the maximum gain will increase.

If you move the slider in the "-" direction, the maximum gain will decrease.

Click the [Reset] button to reset to the default setting.

- **Default:**  
6 <WV-S65300 series> <WV-S61300 series> <WV-U65300 series> <WV-U61300 series>  
9 <WV-S65501-Z1> <WV-S61501-Z1>

#### [DNR]

The digital noise reduction function reduces noise automatically under the condition of low illuminance.

If you move the slider in the "+" direction, the noise reduction effect is strengthened. There may be many afterimages.

If you move the slider in the "-" direction, the noise reduction effect is weakened. There are fewer afterimages.

Click the [Reset] button to reset to the default setting.

**Default:** 128

#### [Super Dynamic(SD)]

Select "On" or "Off" to determine whether or not to activate the super dynamic function.

**Default:** Off

#### [Light control mode]

Select the light control mode from the following.

Outdoor scene/ Indoor scene (50 Hz)/ Indoor scene (60 Hz)/ Fix shutter

**Default:** Outdoor scene

#### [Maximum shutter]

The maximum shutter time adjusts the storage time of the sensor. The following are available for the recording duration.

- When 30fps mode or 15fps mode is selected for [Image capture mode]:

## 2 Settings

---

Max.1/4000s, Max.1/2000s, Max.1/1000s, Max.1/500s, Max.1/250s, Max.1/120s, Max.1/100s, Max.2/120s, Max.2/100s, Max.3/120s, Max.1/30s, Max.2/30s, Max.4/30s, Max.6/30s, Max.10/30s, Max.16/30s

- When 25fps mode or 12.5fps mode is selected for [Image capture mode]:

Max.1/4000s, Max.1/2000s, Max.1/1000s, Max.1/500s, Max.1/250s, Max.1/100s, Max.2/100s, Max.3/100s, Max.1/25s, Max.2/25s, Max.4/25s, Max.6/25s, Max.10/25s, Max.16/25s

**Default:** Max.1/30s

### **[Day & Night(IR)]**

Select switching between the color mode and the black & white mode from the following.

Off/ On/ Auto1(Normal)/ Auto2(IR Light)/ Auto3(SCC)

**Default:** Auto1(Normal)

### **[Intelligent auto]**

Select On/Off to determine whether or not to activate the “Intelligent auto” function.

**Default:** On

## 2.5 Configure the settings relating to audio [Audio]

On the [Audio] tab, the settings relating to audio and alarm can be configured. Check the [Audio] tab of the “Image/Audio” page of the detailed setting menu for detailed explanation about the setting value and cautions at the time of setting.(→“3.6.5 Configure the settings relating to audio [Audio]”)

### **Note**

- Images and audio will not be synchronized. Therefore, images and audio may not always match.
- Audio may be interrupted depending on the network environment.

### **[Mic input volume]**

Set the audio volume for input into the camera. This setting is reflected in the volume when listening to audio on a PC (mic input to PC), and in the volume during “Audio recording”.

Mic High/ Mic Middle/ Mic Low/ Line High/ Line Middle/ Line Low

**Default:** Mic Middle

### **[Audio transmission mode]**

Select the communication mode used for audio data transmission/reception between the camera and the PC from the following:

Off/ Mic Input (To PC)/ Audio output/ Interactive(Half-duplex)/ Interactive(Full-duplex)

**Default:** Off

### **[Audio input encoding format]**

Select the audio input encoding format to be used in the “Live” page from G.726, G.711, or AAC-LC.

- **Default:** AAC-LC

### **[Audio volume control mode]**

Select the operation method using the volume cursor of the Mic input button on the “Live” page.

Adjust PC speaker/Adjust Mic input

**Default:** Adjust Mic input

## 2.6 Configure the settings relating to the alarm

### [Alarm]

The settings relating to alarm can be configured on this page.

Check the [Alarm] tab of the “Alarm” page of the detailed setting menu for detailed explanation about the setting value and cautions at the time of setting. (→“3.9 Configure the alarm settings [Alarm]”)

#### [Terminal 1]

Determine how to use terminal 1.

Off/ Alarm input(TRM1)/ Black & white input/ Auto time adjustment

**Default:** Off

#### [Terminal 2]

Determine how to use terminal 2.

Off/ Alarm input(TRM2)/ Alarm output

**Default:** Off

#### [Terminal 3]

Determine how to use terminal 3.

Off/ Alarm input(TRM3)/ AUX output

**Default:** Off

#### [VMD alarm]

Select “On” or “Off” to determine whether or not to perform VMD.

If the VMD area is not configured, the entire region is configured. To configure the VMD area, use the [VMD area] tab on the “Alarm” page of [Detailed setting]. (→“3.9.5 Configure the VMD settings [VMD area]”)

**Default:** Off

#### [SCD alarm]

Select “On” or “Off” to determine whether or not to perform SCD.

If the SCD area is not configured, the entire region is configured. To configure the SCD area, use the [SCD alarm] tab on the “Alarm” page of [Detailed setting]. (→“3.9.7 Configure the SCD settings [SCD area]”)

**Default:** Off

#### [Audio detection alarm]

Select “On” or “Off” to determine whether or not to perform audio detection. To set the audio detection, set using the [Audio detection] tab on the “Alarm” page of the advanced settings. (→“3.9.9 Configure the settings relating to the audio detection [Audio detection]”)

**Default:** Off

#### [Alarm deactivation time]

Set the duration for which detection is not to be performed after an alarm has been detected. For example, by using this function you can prevent mail from being sent too often when the E-mail notifications are configured to be sent to a mobile terminal or tablet device when an alarm is detected.



5 – 600 seconds

- **Default:** 5s

## 2.7 Shift to the detailed setting and configure the settings relating to screen display [Detailed setting]

### Ext. software

#### [Ext. software] button

Displays the menus on which management of the extension software and the schedule setting can be configured. (→“3.3 Perform management of the extension software and the schedule setting [Ext. software]  ”)

### Network

#### [Network] button

Displays the setup menu relating to network. (→“3.11 Configuring the network settings [Network]”)

### Maintenance

#### [Maintenance] button

Displays the menus on which system log check, firmware upgrade, status check and initialization of the setup menu can be carried out. (→“3.13 Maintenance of the camera [Maintenance]”)

### Camera detailed setting

#### [Advanced settings page] button

Displays the detailed setting menu. (→“3 Detailed settings”)

### Screen display

#### [Color]

Select “Light” or “Dark” for the background color of each menu of the operation panel (→“1.1.2 About the “Live” page”) and the detailed setting menu. (→“3 Detailed settings”)

**Default:** Light

#### [Operation panel layout]

Select “Right”, “Left” or “Bottom” for the layout position of the operation panel. (→“1.1.2 About the “Live” page”)

**Default:** Bottom

## 3 Detailed settings

### 3.1 About the network security

#### 3.1.1 Equipped security functions

The following security functions are featured in this camera.

- ① Access restrictions by the host authentication and the user authentication  
It is possible to restrict users from accessing the camera by setting the host authentication and/or the user authentication to “On”. (→“3.10.1 Configure the settings relating to the user authentication [User auth.]”, “3.10.2 Configure the settings relating to the host authentication [Host auth.]”)
- ② Access restrictions by changing the HTTP port  
It is possible to prevent illegal access such as port scanning, etc. by changing the HTTP port number. (→“Common”)
- ③ Access encryption by the HTTPS function  
It is possible to enhance the network security by encrypting the access to cameras using the HTTPS function. (→“3.11.3 How to configure HTTPS settings”)

#### **IMPORTANT**

- Design and enhance security countermeasures to prevent leakage of information such as image data, authentication information (user name and password), alarm E-mail information, DDNS server information, etc. Perform the countermeasure such as access restriction (using the user authentication) or access encryption (using the HTTPS function).
- After the camera is accessed by the administrator, make sure to close the browser for added security.
- Change the administrator password periodically for added security.
- When using the SNMP function with SNMPv1/v2, do not set a community name that can easily be guessed. (Example: public)  
Use of an easily guessable community name may result in leakage of status information of this product on the network or being used as a stepping stone for illegal access to other devices.

#### **Note**

- When user authentication (authentication error) has failed to pass 8 times within 30 seconds using the same IP address (PC), access to the camera will be denied for a while.

## 3.2 Display the setup menu from a PC

The settings of the camera can be configured on the setup menu.

### IMPORTANT

- The setup menu is only operable by users whose access level is “1. Administrator”. Refer to “3.10.1 Configure the settings relating to the user authentication [User auth.]” for how to configure the access level.

### 3.2.1 How to display the setup menu

1. Display the “Live” page. (→“1.1.1 Monitor images from a single camera”)
  2. The settings panel will be displayed.
  3. Click the [Detailed setting] tab.
  4. Click the [Display] button of the [Camera detailed setting].
- The detailed setting menu will be displayed. Refer to “3.2.3 About the setup menu window” for further information about this menu.

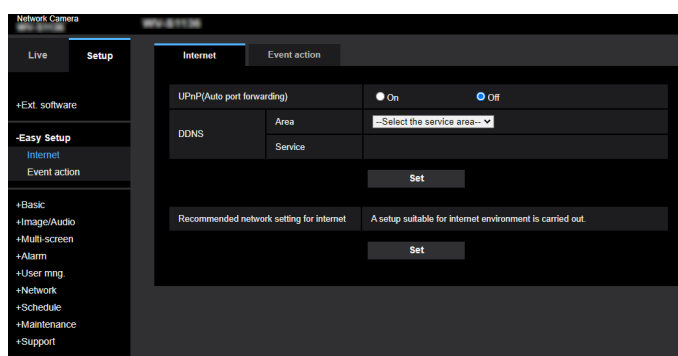

### 3.2.2 How to operate the setup menu

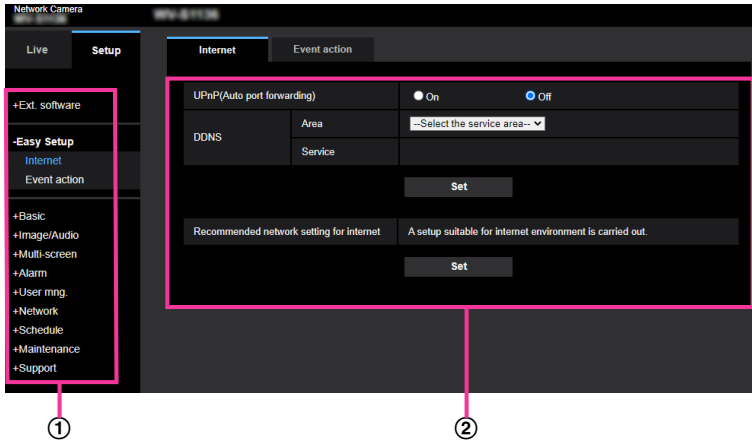

- ① Menu buttons
- ② Setup page

1. Click the desired button in the frame on the left of the window to display the respective setup menu. When there are tabs at the top of the “Setup” page displayed in the frame on the right of the window, click the desired tab to display and configure the setting items relating to the name of the tab.
2. Complete each setting item displayed in the frame on the right of the window.
3. After completing each setting item, click the [Set] button to apply them.

#### IMPORTANT

- When there are two or more [Set], [Register], and [Execute] buttons on the page, click the respective button to the edited setting item.

#### <Example>

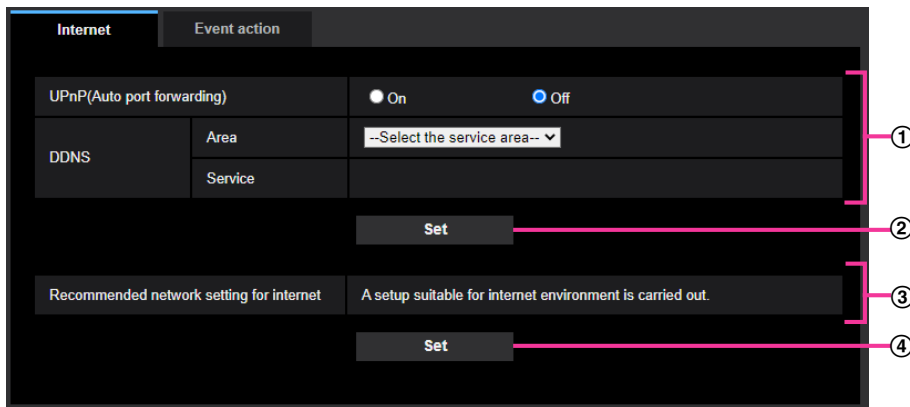

When completing the setting items in field ①, click the [Set] button ② below field ①. The edited settings in field ① will not be applied unless the [Set] button ② below field ① is clicked. In the same manner as above, click the [Set] button ④ below field ③ when completing the setting items in field ③.



### 3.2.3 About the setup menu window

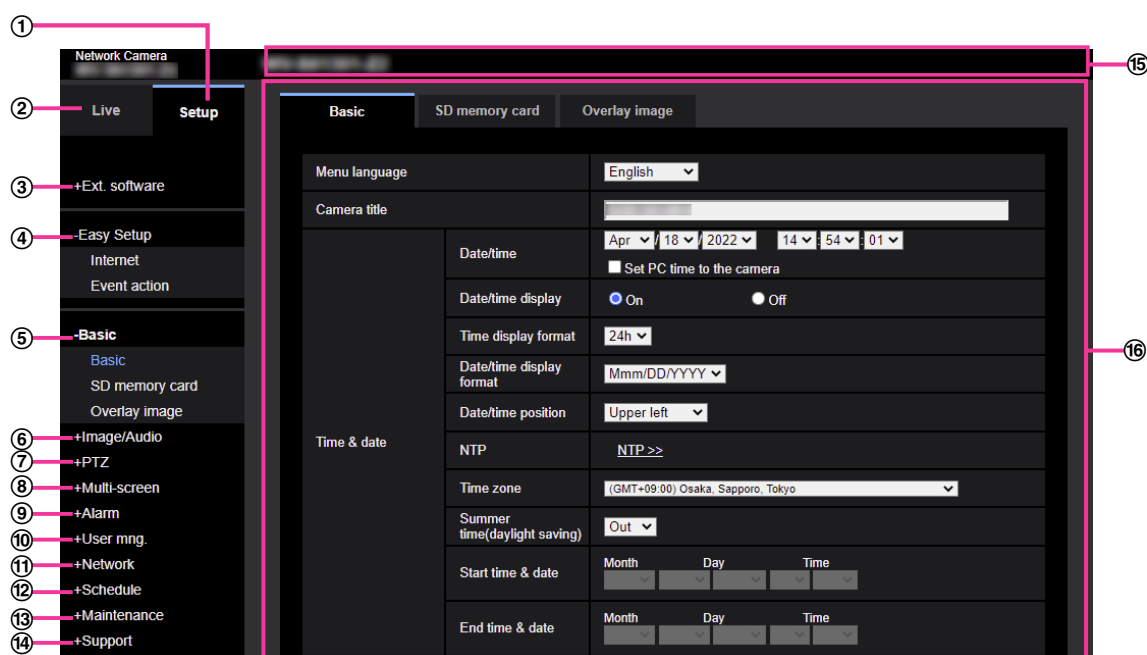

- ① **[Setup] button**  
Display the “Setup” page.
- ② **[Live] button**  
Display the “Live” page.
- ③ **[Ext. software] button** **S613xx** **S653xx**  
Management of the extension software and the schedule setting are available. When the extension software is installed, a link for the screen of the extension software will displayed. (→“3.3 Perform management of the extension software and the schedule setting [Ext. software] **S613xx** **S653xx**”)
- ④ **[Easy Setup] button**  
Displays the “Easy Setup” page. The “Easy Setup” page is used to set the connectivity to the Internet, as well as to set event actions such as alarm settings and camera action on alarm. (→“3.4 Use Easy Setup [Easy Setup]”)
- ⑤ **[Basic] button**  
Displays the “Basic” page. The basic settings such as time and date and camera title, and the settings relating to the SD memory card can be configured on the “Basic” page. (→“3.5 Configure the basic settings of the camera [Basic]”)
- ⑥ **[Image/Audio] button**  
Displays the “Image/Audio” page. The settings relating to image quality, image capture size, etc. of JPEG/H.265/H.264 camera images can be configured on the “Image/Audio” page. (→“3.6 Configure the settings relating to images and audio [Image/Audio]”)
- ⑦ **[PTZ] button**  
Displays the “PTZ” page. The settings relating to the camera operation including the home position setting and self-return can be configured on the “PTZ” page. (→“3.7 Configure the settings relating to PTZ [PTZ]”)
- ⑧ **[Multi-screen] button**  
Displays the “Multi-screen” page. The cameras from which images are to be displayed on a multi-screen can be registered on the “Multi-screen” page. (→“3.8 Configure the multi-screen settings [Multi-screen]”)
- ⑨ **[Alarm] button**  
Displays the “Alarm” page. The settings relating to alarm occurrences such as settings for the alarm action at an alarm occurrence, the VMD area settings, the SCD area settings, the audio detection settings, and

### 3 Detailed settings

---

the alarm occurrence notification can be configured on the on the “Alarm” page. (→“3.9 Configure the alarm settings [Alarm]”)

⑩ **[User mng.] button**

Displays the “User mng.” page. The settings relating to the authentication such as users and PC restrictions for accessing the camera and the data encryption can be configured on the “User mng.” page. (→“3.10 Configure the settings relating to the authentication [User mng.]”)

⑪ **[Network] button**

Displays the “Network” page. The network settings and the settings relating to DDNS (Dynamic DNS), SNMP (Simple Network Management Protocol), the NTP server, QoS, and SRTP can be configured on the “Network” page. (→“3.11 Configuring the network settings [Network]”)

⑫ **[Schedule] button**

Displays the “Schedule” page. On the “Schedule” page, it is possible to designate time zones to allow to activate the VMD function, the SCD function, and the Audio detection function. (→“3.12 Configure the settings relating to the schedules [Schedule]”)

⑬ **[Maintenance] button**

Displays the “Maintenance” page. System log check, firmware upgrade, status check and initialization of the setup menu can be carried out on the “Maintenance” page. (→“3.13 Maintenance of the camera [Maintenance]”)

⑭ **[Support] button**

Displays the “Support” page. The “Support” page contains methods to display our support website. (→“3.14 Display our support website [Support]”)

⑮ **Camera title**

The title of the camera whose settings are currently being configured will be displayed.

⑯ **Setup page**

Pages of each setup menu will be displayed. There are tabs for some setup menus. The bottom of the settings page has been omitted.

## 3.3 Perform management of the extension software and the schedule setting [Ext. software] S613xx S653xx

Management of the extension software and the schedule setting can be performed on the “Ext. software” page. The “Ext. software” page has the [Software mng.] tab, the [Operation sched.] tab, and [Control log] tab.

### Note

- When “16:9 mode(60fps mode)”, “16:9 mode(50fps mode)”, “4:3 mode(15fps mode)” or “4:3 mode(12.5fps mode)” is selected for “Image capture mode”, the extension software will become unusable. The operation schedule of the installed extension software will also be deleted.
- Some AI applications are already installed at the time of purchase. For further information, refer to the respective operating instructions.

### 3.3.1 Perform the installation, uninstallation and version upgrade of the extension software [Software mng.]

Click the “Software mng.” tab of the “Ext. software” page. (→For menu display and how to operate, refer to “3.2.1 How to display the setup menu” and “3.2.2 How to operate the setup menu”.)

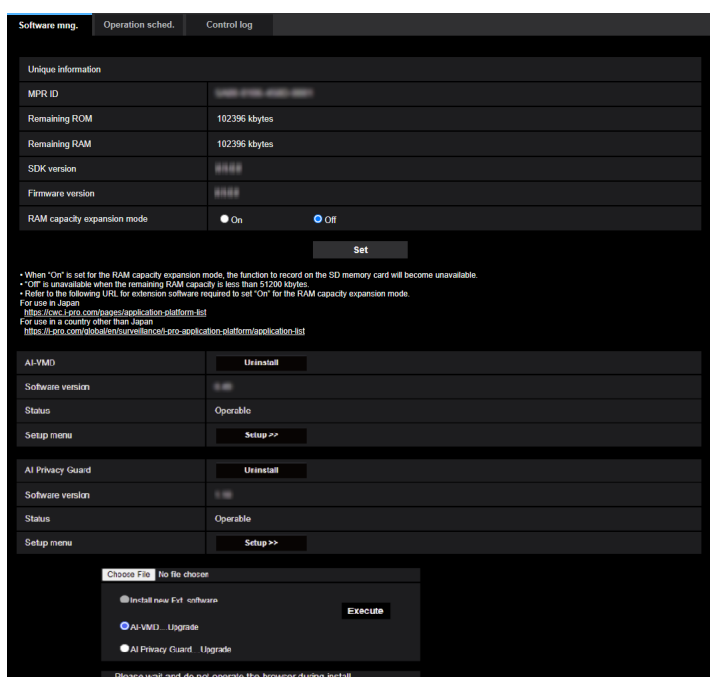

## Installing the extension software

1. Save the extension software to be installed in the PC.

### IMPORTANT

- Check [Remaining ROM] and [Remaining RAM] of the camera. If the Remaining ROM or RAM is not enough to install the extension software, it is necessary to uninstall the other extension software that is already installed. Refer to “[Uninstall] button” for how to uninstall the software.

### 3 Detailed settings

2. Click the [Choose File] button and designate “Ext. software”.
3. Confirm that “Install new Ext. software” is selected and then click the [Execute] button. Installation of the extension software will start. When the installation is completed, the name of the installed extension software will be added to the “Software mng.” screen.

#### **IMPORTANT**

- A space cannot be used in the name of the saving directory.
- Be sure to use the designated file (extension: ext).
- Do not turn off the power of the camera during the installation process.
- Do not perform any operation during the installation process and wait until it completes.

### “Software mng.” screen

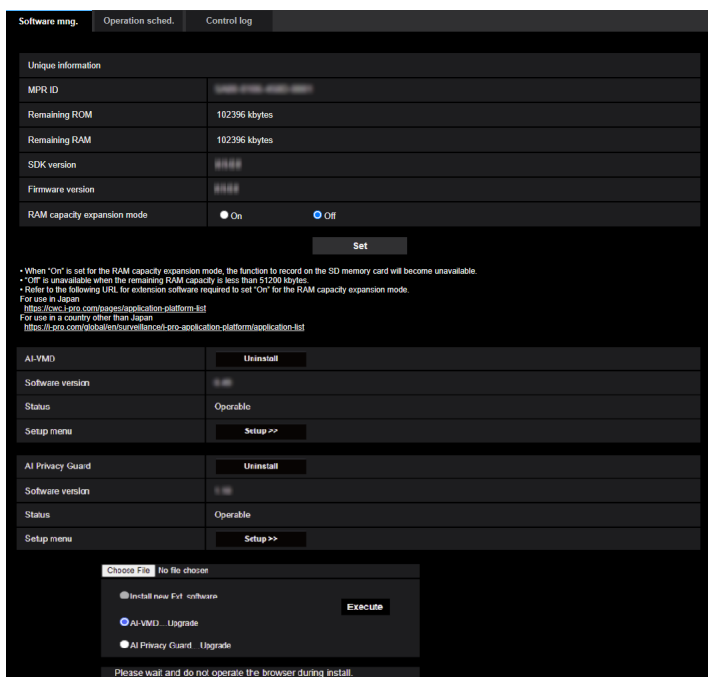

When the extension software is installed, unique information of the camera and the registration status of the extension software will be displayed. On this screen, the following operations are available.

- Uninstallation of the extension software
- Display of the registration status detail screen
- Display of the extension software setting screen
- Update of the extension software

#### **Note**

- **<WV-S65300 series> <WV-S61300 series>**  
Up to two extension software can be installed.
- **<WV-U65300 series> <WV-U61300 series>**  
Installation of multiple extension software is not available.
- **<WV-S65501-Z1> <WV-S61501-Z1>**  
Up to three extension software can be installed.
- For further information about the supported extension software, refer to our technical information website <Control No.: C0103>.

## Unique information

### [MPR ID]

This ID is required to install the extension software. This also has a device ID unique to each camera.

### [Remaining ROM]

The remaining ROM capacity in the camera for the extension software will be displayed. If an extension software to be installed requires more capacity than the ROM capacity displayed here, installation of the extension software is unavailable.

### [Remaining RAM]

The remaining RAM capacity in the camera for the extension software will be displayed. If an extension software to be installed requires more capacity than the RAM capacity displayed here, installation of the extension software is unavailable.

### [SDK version]

Display the version information of the SDK installed in the camera. If the ext. software you install requires a version number higher than the one shown here, the ext. software may not work properly.

### [Software version]

The version information of the installed camera software will be displayed.

**[RAM capacity expansion mode] <WV-S65300 series> <WV-S61300 series> <WV-U65300 series> <WV-U61300 series>**

Select "On" or "Off" to determine whether to perform the RAM capacity expansion.

**Default:** Off

### Note

- When "On" is set for [RAM capacity expansion mode], the function to record on the SD memory card will become unavailable.
- When a negative value is displayed in "Remaining RAM", uninstall the extension software or set "On" for [RAM capacity expansion mode].
- Click the [Set] button to restart the camera. After restarting, the product cannot be operated for about 2 minutes, just like when the power is turned on.
- Our technical information website provides information on the extension software requiring to set "On" for [RAM capacity expansion mode].  
<https://i-pro.com/global/en/surveillance/i-pro-application-platform/application-list>

## Ext. software

### [Uninstall] button

The installed extension software can be uninstalled.

### [Software version]

If you have installed ext. software, the version information of the installed ext. software is displayed along with the version information of the SDK installed in the ext. software.

If the version information of the SDK embedded in the camera is less than the version number required by the ext. software, the ext. software may not operate properly.

### Note

- For ext. software that does not have SDK version information installed, the SDK version information will not be displayed.

### [Status]

The installation status of the extension software will be displayed. When "Operable" is displayed, it is in a state that operation of the installed extension software is available.

### [Setup>>] button

In case that the extension software has a unique screen such as a setting screen, it is possible to display the screen.

### Install new Ext. software

### 3 Detailed settings

---

When installing a new extension software is installed, select this and then select an extension software to be installed.

#### **Upgrade**

The version of the installed extension software can be upgraded by selecting the installed extension software and then clicking the [Execute] button.

### 3.3.2 Set a schedule of the extension software [Operation sched.]

Click the “Operation sched.” tab of the “Ext. software” page. (→For menu display and how to operate, refer to “3.2.1 How to display the setup menu” and “3.2.2 How to operate the setup menu”.)

Select an extension software for which an operation schedule is set.

#### [Operating day of week]

Select “Time table 1”, “Time table 2” or “Off” for each day of the week.

#### [Time table 1] [Time table 2]

From the pull-down menu, select the start time and the end time of the schedule.

To set 24 hours per day, set [00:00] - [00:00].

On/Off option can be set at [Operation content].

#### How to set the schedules

1. Select software for which an operation schedule is set from the extension software list.
2. At [Operating day of week], select a day of week and a time table where the operation schedule is to be set.
3. Specify a period of time on “Time table 1” and “Time table 2” where the schedule is to be executed.  
To execute for 24 hours, specify the period of time as [00:00] - [00:00].
4. Click the [Set] button after completing the settings.

### 3.3.3 Check the control log of extension software [Control log]

The control log about the extension software will be displayed. (→For menu display and how to operate, refer to “3.2.1 How to display the setup menu” and “3.2.2 How to operate the setup menu”.)

Up to 200 control logs can be saved on the built-in memory of the camera.

When the saved control logs have reached the maximum number, the newer logs will overwrite the older control logs. In this case, the oldest log is the first to be overwritten.

The control logs will be displayed in group of 100 logs each, and the logs will be saved even when the power of the camera is turned off.

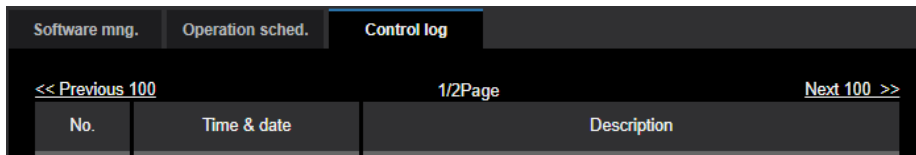

#### [Next 100 >>]

When clicking “Next 100 >>”, the next 100 control logs will be displayed.

#### [Number of pages display]

The currently opened page will be displayed in the “page/total page” format.

#### [<< Previous 100]

When clicking “<< Previous 100”, the previous 100 control logs will be displayed.

#### [No.]

The serial number of the control log will be displayed.

#### [Time & date]

Time and date at the error occurrence will be displayed.

#### [Description]

The descriptions about the control log will be displayed. For further information about the control logs, refer to our technical information website <Control No.: C0317>.



## 3.4 Use Easy Setup [Easy Setup]

The “Easy Setup” page uses simple operations to set the following:

- Make the camera image available on the Internet
- Set event actions such as recording of a schedule/alarm to the SD memory card

The “Easy Setup” page consists of the [Internet] tab and [Event action] tab.

### 3.4.1 Configure the Internet settings [Internet]

Click the [Internet] tab of the “Easy Setup” page. (→“3.2.1 How to display the setup menu“, “3.2.2 How to operate the setup menu”)

The settings relating to UPnP (Auto port forwarding), DDNS (Viewnetcam.com), and network settings for the Internet can be configured on this page.

#### [UPnP (Auto port forwarding)]

Select “On” or “Off” to determine whether or not to use the port forwarding function of the router.

To use the auto port forwarding function, the router in use must support UPnP and the UPnP must be enabled.

- **Default:** Off

#### Note

- Due to auto port forwarding, the port number may sometimes be changed. When the number is changed, it is necessary to change the port numbers registered in the PC and recorders, etc.
- The UPnP function is available when the camera is connected to the IPv4 network. IPv6 is not supported.
- To check if auto port forwarding is properly configured, click the [Status] tab on the “Maintenance” page, and check that the “Enable” is displayed for “Status” of “UPnP”. (→“3.13.3 Check the status [Status]”)  
When “Enable” is not displayed, refer to “Cannot access the camera via the Internet.” in “4.2 Troubleshooting”.
- When the “UPnP (Auto port forwarding)” setting is changed, the “Auto port forwarding” setting under “UPnP” on the [Advanced] tab of the “Network” page also changes to the same setting.
- When the live page or the setting page is not correctly displayed such as when replacing the router in use, set “UPnP (Auto port forwarding)” to “Off” once and then set it to “On” again.

#### [Area]

Select the region where the camera is installed.

Global/Japan

#### Note

- If the camera is used in Japan, select “Japan”. If the camera is used outside of Japan, select “Global”. The “Viewnetcam.com” service that is displayed when “Global” is selected cannot be used in Japan.

#### [Service]

Select “Viewnetcam.com” or “Off” to determine whether or not to use “Viewnetcam.com”.

By selecting “Viewnetcam.com” and clicking the [Set] button, the registration window for “Viewnetcam.com” will be displayed in a newly opened window.

Follow the on-screen instructions to register with “Viewnetcam.com”.

Refer to “When using the “Viewnetcam.com” service” or the “Viewnetcam.com” website (<http://www.viewnetcam.com/>) for further information.

- **Default:** Off

#### Note

- When the “DDNS” setting is changed, the “DDNS” setting on the [Advanced] tab of the “Network” page also changes to the same setting.

#### [Recommended network setting for internet]

The recommended settings for connecting to the Internet are performed here.

By clicking the [Set] button, a dialog displaying how the following settings will change is displayed.

Click the [OK] button after checking the settings to change the settings to the displayed values.

- [Image] tab on the “Image/Audio” page

##### [JPEG(1)]

[Image capture size]: QVGA/320x180

##### [Stream(1)]/[Stream(2)]/[Stream(3)]/[Stream(4)]

[Transmission priority]: Best effort

[Frame rate]: 30 fps

[Max bit rate (per client)\*]: 1024 kbps

##### [Stream(1)]

[Image capture size]: 1280x960/1280x720 <WV-S65300 series> <WV-S61300 series> <WV-U65300 series> <WV-U61300 series>

[Image capture size]: 2560x1920/2560x1440 <WV-S65501-Z1> <WV-S61501-Z1>

##### [Stream(2)]

[Image capture size]: VGA/640x360

##### [Stream(3)]

[Image capture size]: VGA/640x360

##### [Stream(4)]

[Image capture size]: QVGA/320x180

- [Network] tab on the “Network” page

##### [Common]

[Max RTP packet size]: Limited(1280byte)

[HTTP max segment size(MSS)]: Limited(1280byte)

## 3.4.2 Configure an event action [Event action]

Click the [Event action] tab in the “Easy Setup” page. (→“3.2.1 How to display the setup menu”, “3.2.2 How to operate the setup menu”)

The current settings are displayed here.

The screenshot shows the 'Event action' configuration screen. At the top, there are two tabs: 'Internet' and 'Event action', with 'Event action' being the active tab. Below the tabs, there is a header area with some blurred text. The main content area is titled '[Current settings]' and contains two sections: 'Alarm' and 'Schedule'. Each section has a table of settings.

Alarm	
Alarm condition	Off
Alarm	Off
Output terminal	Off
E-mail notification	Off

Schedule	
Schedule	Off

Below the tables, there is a '[Notes]' section with a single bullet point: "When the operating condition is changed, some settings will be cancelled. Confirm the settings after completing the setup." At the bottom of the screen, there is a 'Next' button.

You can set event actions for SD schedule recording/ FTP/SFTP periodic image transmission/ alarm detection. Once the settings are completed in each setup menu, click the [Next] button to proceed. The setup flow is as follows.

### Note

- If you click the [Next] button, the settings in the screen will be saved.

## Flow of event action setup

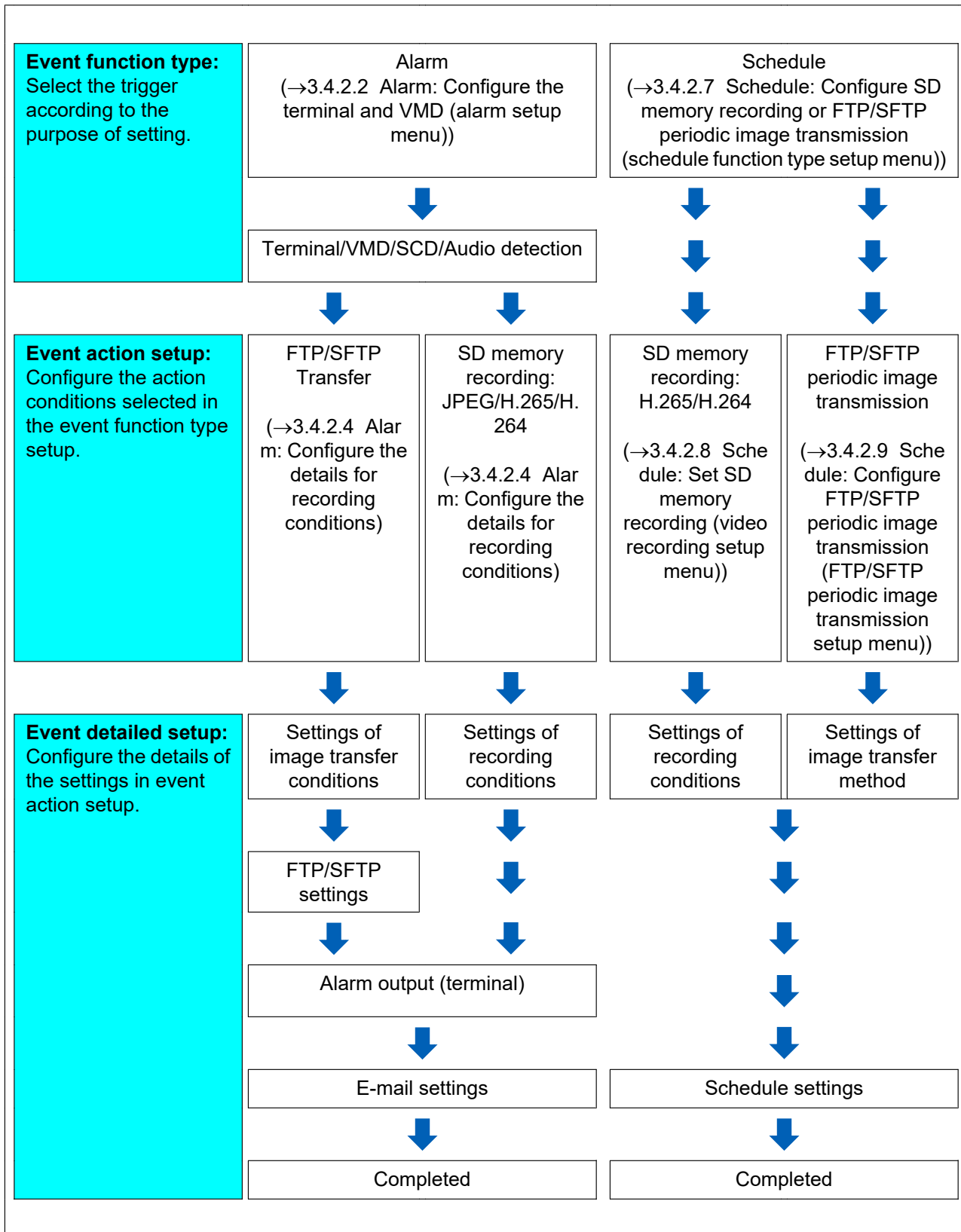

### 3.4.2.1 Configure the schedule/alarm (event function type setup menu)

Here, select the function type of the event.

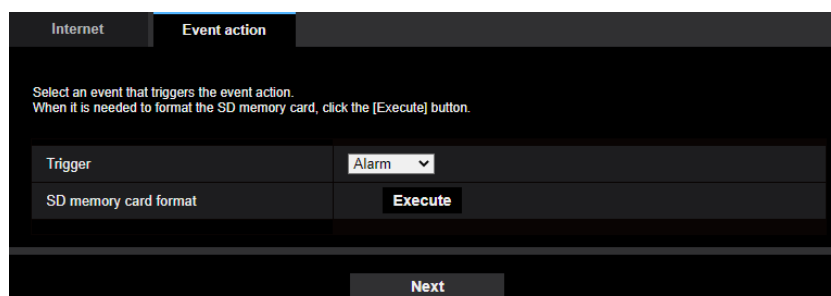

#### [Trigger]

- **Alarm:** Select when setting the alarm detection settings.
- **Schedule:** Select during “SD memory recording” or “FTP/SFTP periodic image transmission”.
- **Default:** Alarm

#### [SD memory card format]

To format the SD memory card, click the [Execute] button.

Once you click the [Execute] button, the “Format” confirmation screen will be displayed.

If you click the [OK] button, the formatting will start.

Once the “Format” completion screen is displayed, press the  button.

#### **IMPORTANT**

- All data saved on the SD memory card will be deleted when the SD memory card is formatted.
- Do not turn off the power of the camera during formatting.

#### [Next] button

If you select “Alarm”, and click the [Next] button, the alarm setup menu will be displayed. (→“3.4.2.2 Alarm: Configure the terminal and VMD (alarm setup menu)”)

If you select “Schedule”, and click the [Next] button, the schedule function type setup menu will be displayed. (→“3.4.2.7 Schedule: Configure SD memory recording or FTP/SFTP periodic image transmission (schedule function type setup menu)”)

### 3.4.2.2 Alarm: Configure the terminal and VMD (alarm setup menu)

The settings relating to actions when an alarm is detected can be configured in this section.

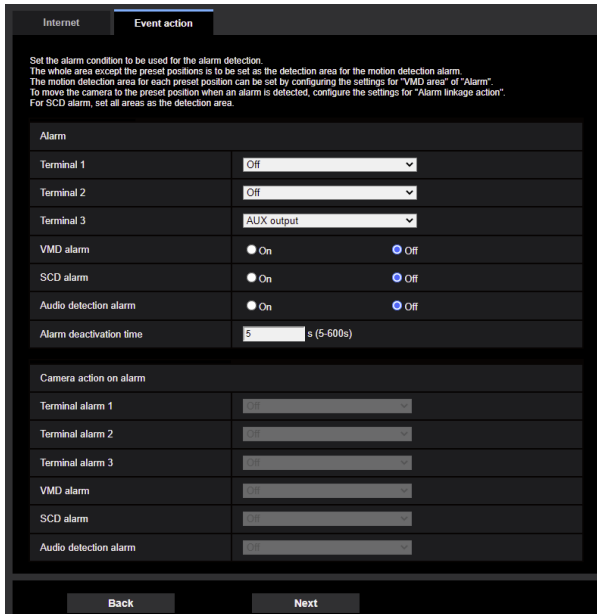

## Alarm

### [Terminal 1]

Determine how to use terminal 1.

- **Off:** Not used.
- **Alarm input(TRM1):** Receives terminal alarm input.
  - **Close:** An alarm is detected when the terminal status is changed to “On”.
  - **Open:** An alarm is detected when the terminal status is changed to “Off”.
  - **Close(Continue):** An alarm is detected when the terminal status is changed to “On”. When “On” is selected for the terminal status, alarm detection will be performed regularly at a fixed interval set by “Alarm deactivation time”.
  - **Open(Continue):** An alarm is detected when the terminal status is changed to “Off”. When “Off” is selected for the terminal status, alarm detection will be performed regularly with the interval set by “Alarm deactivation time”.
- **Black & white input:** Receives the black & white input. (When the input is set to “On”, the black & white mode is activated)
- **Auto time adjustment:** Receives time setting through terminal input. When the signal is entered, if the time difference from the hour (every hour) is less than 29 minutes, the time is adjusted to 00 minutes 00 seconds. During SD memory card recording, the time is not changed in operations which reset the time under 5 seconds. If you select auto time adjustment, the pull-down menu to select close or open is displayed.
  - **Close:** Performs auto time adjustment when the terminal status is changed to “Close”.
  - **Open:** Performs auto time adjustment when the terminal status is changed to “Open”.
- **Default:** Off

### [Terminal 2]

Determine how to use terminal 2.

- **Off:** Not used.

- **Alarm input(TRM2):** Receives terminal alarm input.
  - **Close:** An alarm is detected when the terminal status is changed to “On”.
  - **Open:** An alarm is detected when the terminal status is changed to “Off”.
  - **Close(Continue):** An alarm is detected when the terminal status is changed to “On”. When “On” is selected for the terminal status, alarm detection will be performed regularly at a fixed interval set by “Alarm deactivation time”.
  - **Open(Continue):** An alarm is detected when the terminal status is changed to “Off”. When “Off” is selected for the terminal status, alarm detection will be performed regularly with the interval set by “Alarm deactivation time”.
- **Alarm output:** Alarm output will be carried out according to the settings for “Output terminal”. (→“3.9.2 Configure the settings relating to the output terminal [Alarm]”)
- **Default:** Off

### [Terminal 3]

Determine how to use terminal 3.

- **Off:** Not used.
- **Alarm input(TRM3):** Receives terminal alarm input.
  - **Close:** An alarm is detected when the terminal status is changed to “On”.
  - **Open:** An alarm is detected when the terminal status is changed to “Off”.
  - **Close(Continue):** An alarm is detected when the terminal status is changed to “On”. When “On” is selected for the terminal status, alarm detection will be performed regularly at a fixed interval set by “Alarm deactivation time”.
  - **Open(Continue):** An alarm is detected when the terminal status is changed to “Off”. When “Off” is selected for the terminal status, alarm detection will be performed regularly with the interval set by “Alarm deactivation time”.
- **AUX output:** AUX output is carried out. The [AUX] button will be displayed on the “Live” page.
- **Default:** Off

### [VMD alarm]

- **On:** If the VMD area is not configured, the entire region is configured. To configure the VMD area, use the [VMD area] tab on the “Alarm” page. (→“3.9.6 Set the VMD areas [VMD area]”)
- **Off:** Disables all VMD states.
- **Default:** Off

### [SCD alarm]

- **On:** If the SCD area is not configured, the entire region is configured. To configure the SCD area, use the [SCD area] tab on the “Alarm” page. (→“3.9.7 Configure the SCD settings [SCD area]”)
- **Off:** Disables all SCD states.
- **Default:** Off

### [Audio detection alarm]

- **On:** Uses audio detection alarms. All of the detection targets for AI sound classification will be selected.
- **Off:** Does not use audio detection alarms.
- **Default:** Off

### [Alarm deactivation time]

Set the duration for which detection is not to be performed after an alarm has been detected. For example, by using this function you can prevent mail from being sent too often when the E-mail notifications are configured to be sent to a mobile terminal or tablet device when an alarm is detected.

5 – 600 seconds

- **Default:** 5s

#### Note

- The duration of the alarm deactivation time can be specified for each type of alarm. For example, during the time when detections for “Terminal alarm 1” are not made, detections for “VMD alarm” can be made.

## Camera action on alarm

### [Terminal alarm 1]

Select an action to be taken when a terminal alarm 1 is detected from the following.

This setting is available when “Terminal 1” is selected for “Alarm input(TRM1)” of the [Alarm] tab.

- **Off:** Does not take any action even when a terminal alarm 1 is detected.
- **1-256:** If a previously registered preset position is selected, when a terminal alarm 1 is detected, the camera will move to that position.
- **Patrol 1:** When a terminal alarm 1 is detected, the camera will start the patrol.  
\* If “Patrol 1” is not registered, it is not displayed on the screen.
- **Default:** Off

### [Terminal alarm 2]

Select an action to be taken when a terminal alarm 2 is detected from the following.

This setting is available when “Terminal 2” is selected for “Alarm input(TRM2)” of the [Alarm] tab.

- **Off:** Does not take any action even when a terminal alarm 2 is detected.
- **1-256:** If a previously registered preset position is selected, when a terminal alarm 2 is detected, the camera will move to that position.
- **Patrol 2:** When a terminal alarm 2 is detected, the camera will start the patrol.  
\* If “Patrol 2” is not registered, it is not displayed on the screen.
- **Default:** Off

### [Terminal alarm 3]

Select an action to be taken when a terminal alarm 3 is detected from the following.

This setting is available when “Terminal 3” is selected for “Alarm input(TRM3)” of the [Alarm] tab.

- **Off:** Does not take any action even when a terminal alarm 3 is detected.
- **1-256:** If a previously registered preset position is selected, when a terminal alarm 3 is detected, the camera will move to that position.
- **Patrol 3:** When a terminal alarm 3 is detected, the camera will start the patrol.  
\* If “Patrol 3” is not registered, it is not displayed on the screen.
- **Default:** Off

### [VMD alarm]

Select an action to be taken when a VMD alarm is detected from the following.

- **Off:** Does not take any action even when a VMD alarm is detected.
- **1-256:** If a previously registered preset position is selected, when a VMD alarm is detected, the camera will move to that position.
- **Patrol 1:** When a VMD alarm is detected, the camera will start the patrol.  
\* If “Patrol 1” is not registered, it is not displayed on the screen.
- **Default:** Off

### [SCD alarm]

Select an action to be taken when an SCD alarm is detected from the following.

- **Off:** Does not take any action even when an SCD alarm is detected.
- **1-256:** If a previously registered preset position is selected, when an SCD alarm is detected, the camera will move to that position.
- **Default:** Off



**[Audio detection alarm]**

Select an action to be taken when a sound alarm is detected from the following.

- **Off:** Does not take any action even when a sound alarm is detected.
- **1-256:** If a previously registered preset position is selected, when a sound alarm is detected, the camera will move to that position.
- **Patrol 1:** When a sound alarm is detected, the camera will start the patrol.  
\* If “Patrol 1” is not registered, it is not displayed on the screen.
- **Default:** Off

**[Next] button**

If you click the [Next] button, the alarm function type setup menu will be displayed. (→“3.4.2.3 Alarm: Configure the alarm function type (Alarm function type setup menu)”)

**Note**

- If you click the [Next] button, the setting items in the screen are saved.

**[Back] button**

If you click the [Back] button, the event function type setup menu will be displayed. (→“3.4.2.1 Configure the schedule/alarm (event function type setup menu)”)

### 3.4.2.3 Alarm: Configure the alarm function type (Alarm function type setup menu)

Configure “Recording format” of SD memory recording triggered by an alarm occurrence.

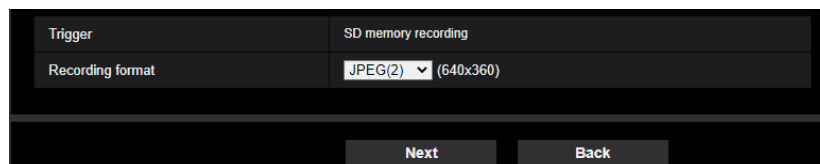
**[Trigger]**

- **FTP/SFTP img. trans.:** when an alarm occurs, performs FTP/SFTP transfer of the JPEG image.
- **SD memory recording:** When an alarm occurs, records the image to the SD memory card.

**Note**

- “FTP/SFTP img. trans.” for when an alarm occurs and “FTP/SFTP periodic image transmission” can be set to perform simultaneously.
- When “FTP/SFTP img. trans.” for when an alarm occurs and “FTP/SFTP periodic image transmission” are set to perform simultaneously, “FTP/SFTP img. trans.” for when an alarm occurs will be given priority to be performed.
- The protocol used for image transmission by “FTP/SFTP img. trans.” for when an alarm occurs can be set on the FTP/SFTP transfer setup menu. (→“① Configure FTP/SFTP transfer (FTP/SFTP transfer setup menu)”)

**[Recording format]**

Select the recording format by selecting from “JPEG(1)”, “JPEG(2)”, “Stream(1)”, “Stream(2)”, “Stream(3)” and “Stream(4)”.

#### **[Next] button**

If you select “FTP/SFTP img. trans.” for “Trigger” and click the [Next] button, the FTP/SFTP transfer setup menu will be displayed. (→“① Configure FTP/SFTP transfer (FTP/SFTP transfer setup menu)”)

If you select “SD memory recording” for “Trigger”, select “JPEG(1)” or “JPEG(2)” for “Recording format”, and then click the [Next] button, the JPEG recording setup menu will be displayed. (→“② Configure SD memory recording (JPEG) (JPEG recording setup menu)”)

If you select “SD memory recording” for “Trigger”, select “Stream(1)”, “Stream(2)”, “Stream(3)”, or “Stream(4)” for “Recording format”, and then click the [Next] button, the video recording setup menu will be displayed. (→“③ Configure SD memory recording (H.265 or H.264) (video recording setup menu)”)

#### **Note**

- If you click the [Next] button, the setting items in the screen are saved.
- Even when the audio detection alarm is set, alarm recording onto the SD memory card will not be performed.

#### **[Back] button**

If you click the [Back] button the alarm setup menu will be displayed. (→“3.4.2.2 Alarm: Configure the terminal and VMD (alarm setup menu)”)

### 3.4.2.4 Alarm: Configure the details for recording conditions

#### ① Configure FTP/SFTP transfer (FTP/SFTP transfer setup menu)

FTP/SFTP transfer when an alarm is detected is set in this section.

The screenshot shows the 'Event action' configuration screen. At the top, there are tabs for 'Internet' and 'Event action'. Below the tabs, there is a heading: 'Set the method of image transmission to the FTP/SFTP server when an alarm is detected.'

The configuration is organized into several sections:

- Transmission protocol:** Radio buttons for FTP and SFTP.
- Alarm setting:** Radio buttons for On and Off.
- Directory name:** A text input field.
- File name:** Checkboxes for Terminal 1, Terminal 2, Terminal 3, VMD, SCD, and Audio detection. A note below states: '\* For alarms by the "Ext. software", alarm images will be transmitted only by configuring the alarm image SFTP transmission.'
- FTP transmission retry:** Radio buttons for On and Off.
- Pre alarm:** Fields for Transmission interval, Maximum number of images, and Recording duration (0s).
- Post alarm:** Fields for Transmission interval, Number of images, and Recording duration (100s).
- Image capture size:** A dropdown menu showing JPEG(2) and (640x360).
- SFTP server setting:** Fields for SFTP server address (with example: 192.168.0.10), Port number (22, range 1-65535), Host key hash (SHA256, with example: dqVcdVZ/2ySO5tz/R6YR+rbW6dnap6P743uiMV0cf0), User name, and Password.
- FTP server setting:** Fields for FTP server address (with example: 192.168.0.10), User name, Password, Control port (21, range 1-65535), and FTP mode (Passive/Active).

At the bottom of the screen, there are 'Back' and 'Next' buttons.

Refer to “3.11.2.2 Add FTP/SFTP image transmission function” for information about how to configure the above screen.

#### [Next] button

If you select “Alarm output” in the alarm setup menu and click the [Next] button, the alarm output setup menu will be displayed. (→“3.4.2.5 Alarm: Configure the output terminal”)

If you click the [Next] button in the alarm setup menu without selecting “Alarm output”, the mail setup menu will be displayed. (→“3.4.2.6 Alarm: configure the mail notifications and mail server”)

#### Note

- If you click the [Next] button, the setting items in the screen are saved.

### 3 Detailed settings

#### [Back] button

If you click the [Back] button, the alarm function type setup menu will be displayed. (→“3.4.2.3 Alarm: Configure the alarm function type (Alarm function type setup menu)”)

## ② Configure SD memory recording (JPEG) (JPEG recording setup menu)

The SD memory recording (JPEG) when an alarm is detected is configure in this section.

JPEG recording(Alarm)		
File name	img_	
Image saving interval/Number of images to be saved(Pre alarm)	Image saving interval 1fps	Number of images to be saved Off
Image saving interval/Number of images to be saved(Post alarm)	Image saving interval 1fps	Number of images to be saved 100 pics
Next      Back		

Refer to “JPEG recording(Alarm)” of 3.5.2 Configure the settings relating to the SD memory card [SD memory card] for information about how to set the above screen.

#### [Next] button

If you select “Alarm output” in the alarm setup menu and click the [Next] button, the alarm output setup menu will be displayed. (→“3.4.2.5 Alarm: Configure the output terminal”)

If you click the [Next] button in the alarm setup menu without selecting “Alarm output”, the mail setup menu will be displayed. (→“3.4.2.6 Alarm: configure the mail notifications and mail server”)

#### [Back] button

If you click the [Back] button, the alarm function type setup menu will be displayed. (→“3.4.2.3 Alarm: Configure the alarm function type (Alarm function type setup menu)”)

## ③ Configure SD memory recording (H.265 or H.264) (video recording setup menu)

The SD memory recording (H.265 or H.264) when an alarm is detected is configured in this section.

Stream recording(Alarm)	
Audio recording	<input type="radio"/> On <input checked="" type="radio"/> Off
Frame rate*	30fps *
Pre alarm (recording) duration	Off
Post alarm (recording) duration	30s
Next      Back	

#### [Audio recording]

Select On/Off to determine whether or not to record audio data.

- **On:** Saves audio data to videos (MP4 format).
- **Off:** Does not save audio data to videos (MP4 format).

**Note**

- This setting is not available when “Interactive(Half-duplex)” is selected for “Audio transmission mode”.

**[Frame rate]**

Select a frame rate for the H.265 (or H.264) to be recorded.

**Note**

- Refer to “[Frame rate\*]” in “3.4.2.8 Schedule: Set SD memory recording (video recording setup menu)” for information about available frame rates and the bit rates that are set according to the frame rate.

**[Pre alarm (recording) duration]**

Determine whether or not to perform the pre alarm recording. Set the duration to save image data on the SD memory card.

Off/ 1s/ 2s/ 3s/ 4s/ 5s/ 8s/ 10s/ 15s/ 20s/ 25s/ 30s/ 40s/ 50s/ 60s/ 90s/ 120s

- **Default:** Off

**Note**

- The values change depending on the bit rate and the image capture size of the recorded stream. As the selected bit rate increases, the available maximum value for the pre alarm duration decreases.

**[Post alarm (recording) duration]**

Set the duration to save image data on the SD memory card after an alarm occurrence.

10s/ 20s/ 30s/ 40s/ 50s/ 60s/ 120s/ 180s/ 240s/ 300s

- **Default:** 30s

\* The actual recording time may sometimes be longer than the duration selected for this setting.

**[Next] button**

If you select “Alarm output” in the alarm setup menu and click the [Next] button, the alarm output setup menu will be displayed. (→“3.4.2.5 Alarm: Configure the output terminal”)

If you click the [Next] button in the alarm setup menu without selecting “Alarm output”, the mail setup menu will be displayed. (→“3.4.2.6 Alarm: configure the mail notifications and mail server”)

**Note**

- If you click the [Next] button, the setting items in the screen are saved.

**[Back] button**

If you click the [Back] button, the alarm function type setup menu will be displayed. (→“3.4.2.3 Alarm: Configure the alarm function type (Alarm function type setup menu)”)

## 3.4.2.5 Alarm: Configure the output terminal

Alarm output is configured in this section. This screen will be displayed when “Alarm output” is selected in the alarm setup menu.

### 3 Detailed settings

---

- To configure settings relating to the output terminal:

Output terminal	
Terminal output upon alarm detection	<input type="radio"/> On <input checked="" type="radio"/> Off
SD memory card error	<input type="radio"/> On <input checked="" type="radio"/> Off
Terminal state upon alarm detection	<input type="radio"/> Latch <input type="radio"/> Pulse
Terminal action upon alarm detection	<input type="radio"/> Open <input type="radio"/> Close
Pulse output width	<input type="text"/> s (1-120s)

Refer to “3.9.2 Configure the settings relating to the output terminal [Alarm]” for information about how to configure the above screen.

#### **[Next] button**

If you click the [Next] button, the mail setup menu will be displayed. (→“3.4.2.6 Alarm: configure the mail notifications and mail server”)

#### **Note**

- If you click the [Next] button, the setting items in the screen are saved.

#### **[Back] button**

If you click the [Back] button, either the FTP/SFTP transmission setting page (→“① Configure FTP/SFTP transfer (FTP/SFTP transfer setup menu)”), the JPEG recording setup menu (→“② Configure SD memory recording (JPEG) (JPEG recording setup menu)”), or the video recording setup menu (→“③ Configure SD memory recording (H.265 or H.264) (video recording setup menu)”) will be displayed.

### 3.4.2.6 Alarm: configure the mail notifications and mail server

The settings relating to e-mail can be configured in this section.

- To configure e-mail related settings:

Internet | **Event action**

Set the method of mail notification when an alarm is detected.

**E-mail notification**

E-mail notification  On  Off

Alarm image attachment  On  Off

Image capture size  (640x360)

SMTP server address

SMTP port

POP server address

Authentication

Type  None  POP before SMTP  SMTP

User name

Password

Sender's E-mail address

SSL  On  Off

**Destination of notification**

Destination E-mail address

Address 1

Terminal 1  Terminal 2  Terminal 3

VMD  SCD  Audio detection

Diag.  Auto track

\* For alarms by the "Ext. Software", e-mail notification will be provided only by configuring the destination e-mail address setting.

Address 2

Terminal 1  Terminal 2  Terminal 3

VMD  SCD  Audio detection

Diag.  Auto track

\* For alarms by the "Ext. Software", e-mail notification will be provided only by configuring the destination e-mail address setting.

Address 3

Terminal 1  Terminal 2  Terminal 3

VMD  SCD  Audio detection

Diag.  Auto track

\* For alarms by the "Ext. Software", e-mail notification will be provided only by configuring the destination e-mail address setting.

Address 4

Terminal 1  Terminal 2  Terminal 3

VMD  SCD  Audio detection

Diag.  Auto track

\* For alarms by the "Ext. Software", e-mail notification will be provided only by configuring the destination e-mail address setting.

E-mail subject(Alarm)  Use the camera title  Cause of alarm

E-mail subject(Diag)  Use the camera title

E-mail body(Alarm)  Cause of alarm  Occurrence time

Refer to "3.11.2.1 Configure the settings related to sending E-mails" for information about how to configure the above screen.

#### [Set] button

If you click the [Set] button, setup will be completed.

#### [Back] button

If you click the [Back] button, either the FTP/SFTP transmission setting page (→“① Configure FTP/SFTP transfer (FTP/SFTP transfer setup menu)”), the JPEG recording setup menu (→“② Configure SD memory recording (JPEG) (JPEG recording setup menu)”), or the video recording setup menu (→“③ Configure SD memory recording (H.265 or H.264) (video recording setup menu)”) will be displayed.

#### 3.4.2.7 Schedule: Configure SD memory recording or FTP/SFTP periodic image transmission (schedule function type setup menu)

Here, the schedule type is selected as “SD memory recording” or “FTP/SFTP periodic image transmission”.

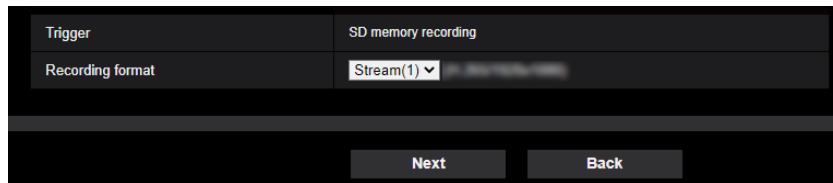

#### [Trigger]

- **SD memory recording:** Records the H.265 (or H.264) image in the SD memory card at the scheduled time.
- **FTP/SFTP periodic image transmission:** Transmits the JPEG image to the FTP/SFTP server at the scheduled time.

#### [Recording format]

When “SD memory recording” is selected for “Trigger”, “Stream(1)”, “Stream(2)”, “Stream(3)”, or “Stream(4)” can be selected for the recorded image.

#### [Next] button

If you select “SD memory recording” and click the [Next] button, the video recording setup menu will be displayed. (→“3.4.2.8 Schedule: Set SD memory recording (video recording setup menu)”)

If you select “FTP/SFTP periodic image transmission” and click the [Next] button, the FTP/SFTP periodic image transmission setup menu will be displayed. (→“3.4.2.9 Schedule: Configure FTP/SFTP periodic image transmission (FTP/SFTP periodic image transmission setup menu)”)

#### Note

- If you click the [Next] button, the setting items in the screen are saved.

#### [Back] button

If you click the [Back] button, the event function type setup menu will be displayed. (→“3.4.2.1 Configure the schedule/alarm (event function type setup menu)”)

#### Note

- “FTP/SFTP periodic image transmission” and “FTP/SFTP img. trans.” for when an alarm occurs can be set to perform simultaneously.
- If you select “SD memory recording”, the “FTP/SFTP periodic image transmission” setting will be canceled.



### 3.4.2.8 Schedule: Set SD memory recording (video recording setup menu)

Here, SD memory recording (H.265 or H.264) is configured according to the schedule.

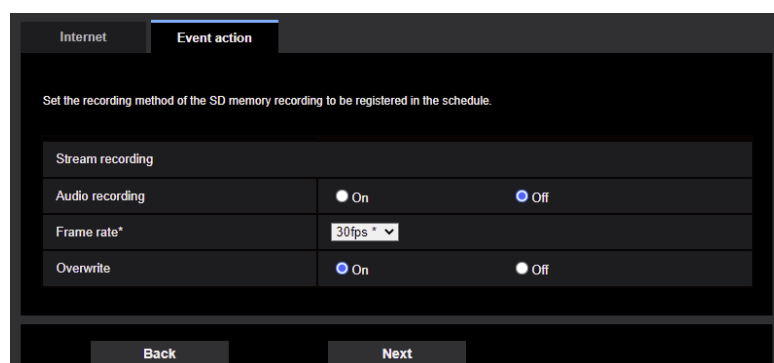

#### [Audio recording]

Determine whether or not to perform audio recording.

- **On:** Saves audio data to videos (MP4 format).
- **Off:** Does not save audio data to videos (MP4 format).
- **Default:** Off

#### Note

- This setting is not available when “Interactive(Half-duplex)” is selected for “Audio transmission mode”.

### **IMPORTANT**

- When the [Overwrite] setting is changed from “Off” to “On”, if the remaining capacity of the SD memory card is low, old images may be deleted in order to prepare to save new images.

#### [Frame rate\*]

Select a frame rate for the H.265 or H.264 to be recorded from the following.

- When 30fps mode is selected for [Image capture mode]:  
1fps/ 3fps/ 5fps\*/ 7.5fps\*/ 10fps\*/ 12fps\*/ 15fps\*/ 20fps\*/ 30fps\*
- When 25fps mode is selected for [Image capture mode]:  
1fps/ 3.1fps/ 4.2fps\*/ 6.25fps\*/ 8.3fps\*/ 12.5fps\*/ 20fps\*/ 25fps\*
- When 15fps mode is selected for [Image capture mode]:  
1fps/ 3fps/ 5fps\*/ 7.5fps\*/ 10fps\*/ 12fps\*/ 15fps\*
- When 12.5fps mode is selected for [Image capture mode]:  
1fps/ 3.1fps/ 4.2fps\*/ 6.25fps\*/ 8.3fps\*/ 12.5fps\*
- **Default:** 30fps\*

#### Note

- If you click the [Next] button, the “Transmission priority” will be set to “Frame rate”. (→[Transmission priority])

The bit rate will automatically be set according to the selected image capture size and frame rate.

Check the set bit rate at “Max bit rate (per client)\*” of each stream.

Unit: kbps

#### **[Overwrite]**

Determine whether or not to overwrite images when the remaining capacity of the SD memory card becomes insufficient.

- **On:** Overwrites when the remaining capacity of the SD memory card becomes insufficient. (The oldest image is the first to be overwritten.)
- **Off:** Stops saving images on the SD memory card when the SD memory card becomes full.
- **Default:** On

#### **IMPORTANT**

- When the [Overwrite] setting is changed from “Off” to “On”, if the remaining capacity of the SD memory card is low, old images may be deleted in order to prepare to save new images.

#### **[Next] button**

If you click the [Next] button, the setup menu to set the schedule for recording into the SD memory card will be displayed. (→“To configure the schedule settings.”)

#### **[Back] button**

If you click the [Back] button, the schedule function type setup menu will be displayed. (→“3.4.2.7 Schedule: Configure SD memory recording or FTP/SFTP periodic image transmission (schedule function type setup menu)”)

- To configure the schedule settings:

Internet    Event action

Select "Recording to SD (Recording stream)" for "Schedule mode" of the schedule (1 - 5) to be registered, and set the recording schedule.  
When "Recording to SD (Recording stream)" is not selected for "Schedule mode", recording will not be performed.

Schedules

Schedule	Schedule mode	Time range
Schedule 1 (White)	On	24h
Schedule 2 (Blue)	On	24h
Schedule 3 (Green)	On	24h
Schedule 4 (Red)	On	24h
Schedule 5 (Black)	On	24h
Schedule 6 (Yellow)	On	24h
Schedule 7 (Light blue)	On	24h
Schedule 8 (Purple)	On	24h

0.00    6.00    12.00    18.00    24.00

Mon  
Tue  
Wed  
Thu  
Fri  
Sat  
Sun

The color of each schedule is not linked with the area color of "VMD area".  
When "VMD permission" is set, the VMD functions in all the areas set with "VMD area".  
"VMD permission" and "SD" permission are required when assigning the period to be detected. Setting is not necessary when detection at any time.  
If the camera direction is changed by other operation while the setting of preset position, auto pan, preset sequence or patrol is being performed, the camera will automatically move back to the previous preset position and resume the operation in 1 minute.

Back    Set

Refer to "3.12 Configure the settings relating to the schedules [Schedule]" for information about how to set the above screen.

### [Set] button

If you click the [Set] button, setup will be completed.

### [Back] button

If you click the [Back] button, the (video recording setup menu will be displayed. (→"3.4.2.8 Schedule: Set SD memory recording (video recording setup menu)")

### 3 Detailed settings

---

#### **Note**

- Video recording is not performed if “SD memory recording” is not selected in the “Schedule mode”.

### 3.4.2.9 Schedule: Configure FTP/SFTP periodic image transmission (FTP/SFTP periodic image transmission setup menu)

The FTP/SFTP periodic image transmission is configured in this section.

- To configure FTP/SFTP periodic image transmission settings:

Internet | **Event action**

Configure the FTP/SFTP server information and the method of JPEG image transmission to the FTP/SFTP server.

Transmission protocol	<input type="radio"/> FTP <input checked="" type="radio"/> SFTP
Periodic transmission settings	
Periodic image transmission	<input type="radio"/> On <input checked="" type="radio"/> Off
Directory name	<input type="text"/>
File name	<input type="text"/> <input type="radio"/> Name w/time&date <input type="radio"/> Name w/o time&date
Transmission interval	15 <input type="text"/>
Image capture size	JPEG(2) (640x360)
SFTP server setting	
SFTP server address	<input type="text"/> Example of entry: 192.168.0.10
Port number	22 (1-65535)
Host key hash	SHA256: <input type="text"/> Example of entry: dqVcdVZl2ySO5tz/R6YR+rpBW6dnap6P743uiMV0cf0
User name	<input type="text"/>
Password	<input type="password"/>
FTP server setting	
FTP server address	<input type="text"/> Example of entry: 192.168.0.10
User name	<input type="text"/>
Password	<input type="password"/>
Control port	21 (1-65535)
FTP mode	<input type="radio"/> Passive <input type="radio"/> Active

Back Set

Refer to “3.11.2.2 Add FTP/SFTP image transmission function” for information about how to configure the above screen.

#### [Set] button

“FTP/SFTP periodic image transmission” is displayed as “Off”.  
Click the [Set] button to save the settings.

#### [Next] button

“FTP/SFTP periodic image transmission” is displayed as “On”.  
If you click the [Next] button, the setup menu to set the FTP/SFTP periodic image transmission schedule will be displayed. (→“To configure FTP/SFTP periodic image transmission schedule settings.”)

### 3 Detailed settings

#### Note

- If you click the [Next] button, the setting items in the screen are saved.

#### [Back] button

If you click the [Back] button, the schedule function type setup menu will be displayed. (→“3.4.2.7 Schedule: Configure SD memory recording or FTP/SFTP periodic image transmission (schedule function type setup menu)”)

- To configure FTP/SFTP periodic image transmission schedule settings:

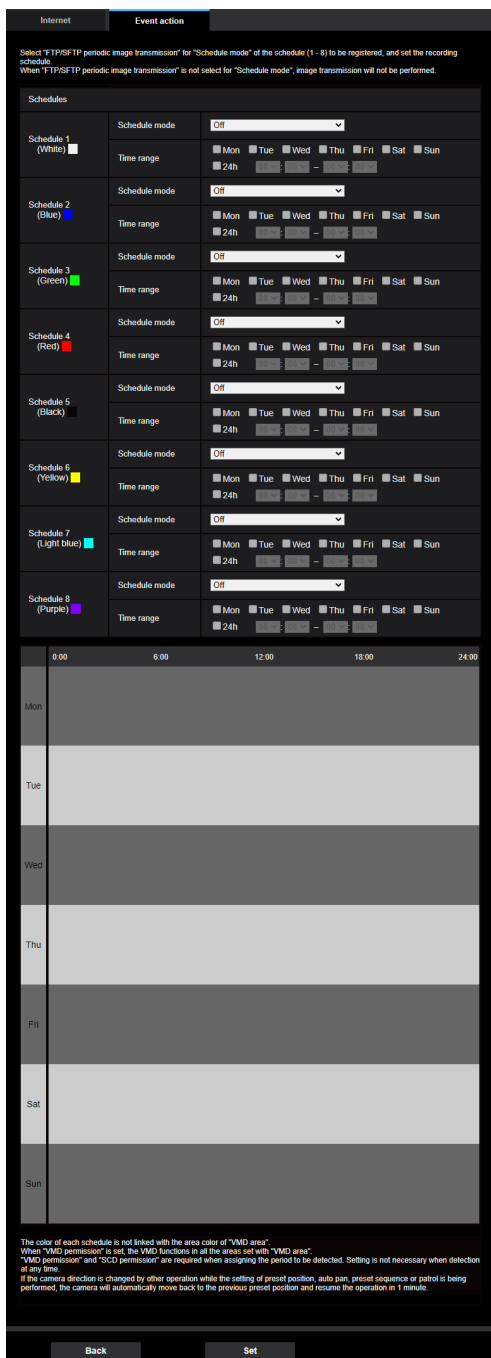

Refer to “3.12 Configure the settings relating to the schedules [Schedule]” for information about how to set the above screen.

#### **[Set] button**

If you click the [Set] button, setup will be completed.

#### **[Back] button**

If you click the [Back] button, the FTP/SFTP periodic image transmission setup menu will be displayed. (→“To configure FTP/SFTP periodic image transmission settings.”)

#### **Note**

- FTP/SFTP periodic image transmission will not be performed when “FTP/SFTP periodic image transmission” is not selected in “Schedule mode”.

## 3.5 Configure the basic settings of the camera [Basic]

The basic settings such as camera title, time and date, SD memory card and the logs can be configured on the “Basic” page. The “Basic” page has the [Basic] tab, the [SD memory card] tab, and the [Overlay image] tab.

### 3.5.1 Configure the basic settings [Basic]

Click the [Basic] tab on the “Basic” page. (→“3.2.1 How to display the setup menu”, “3.2.2 How to operate the setup menu”)

The settings such as the camera title, time and date, etc. can be configured on this page.

#### [Menu language]

Select the language to initially display when the camera is accessed from the following.  
Auto/English/Japanese/Italian/French/German/Spanish/Chinese/Russian/Portuguese

- **Auto:** The language used by the browser is automatically selected. If the language used by the browser is not supported by the camera, English is selected.
- **Default:** Auto

#### [Camera title]

Enter the title of the camera. Click the [Set] button after entering the title of the camera. The entered title will be displayed in the “Camera title” field.

- **Available number of characters:** 0 - 20 characters
- **Unavailable characters:** " &
- **Default:** The model No. is displayed.

#### [Date/time]

Enter the current time and date. When “12h” is selected for “Time display format”, “AM” or “PM” can be selected. The date and time of the PC will be obtained and set it to the camera by checking the “Set PC time to the camera” checkbox and then clicking the [Set] button.

- **Available range:** Jan/01/2013 00:00:00 - Dec/31/2035 23:59:59

#### **IMPORTANT**

- Use an NTP server when the more accurate time & date setting is required for the system operation. (→“3.11.2.3 Configure the settings relating to the NTP server”)

#### [Date/time display]

Select On/Off to determine whether or not to display the date and time on an image. To hide the date and time, select “Off”.

- **Default:** On

#### [Time display format]

Select the time display format from “24h” and “12h”. Enter the current hour reflecting this setting when entering the current time and date for “Date/time”.

- **Default:** 24h

#### [Date/time display format]

Select a date/time display format. When “2020/04/01 13:10:00” is set for “Date/time” after selecting “24h” for “Time display format”, time & date will be respectively displayed as follows.

- **DD/MM/YYYY:** 01/04/2020 13:10:00



- **MM/DD/YYYY:** 04/01/2020 13:10:00
- **DD/Mmm/YYYY:** 01/Apr/2020 13:10:00
- **YYYY/MM/DD:** 2020/04/01 13:10:00
- **Mmm/DD/YYYY:** Apr/01/2020 13:10:00
- **Default:** Mmm/DD/YYYY

### [Date/time position]

Select the position to display the time and date in an image.

- **Upper left:** The information will be displayed at the upper left corner of the screen.
- **Lower left:** The information will be displayed at the lower left corner of the screen.
- **Upper center:** The information will be displayed at the upper center of the screen.
- **Lower center:** The information will be displayed at the lower center of the screen.
- **Upper right:** The information will be displayed at the upper right corner of the screen.
- **Lower right:** The information will be displayed at the lower right corner of the screen.
- **Default:** Upper left

### [NTP]

When “NTP >>” is clicked, the [Advanced] tab of the “Network” page will be displayed. (→“3.11.2.3 Configure the settings relating to the NTP server”)

### [Time zone]

Select a time zone corresponding to the location where the camera is in use.

- **Default:** (GMT +09:00) Osaka, Sapporo, Tokyo

### [Summer time (daylight saving)]

Select “In”, “Out” or “Auto” to determine whether or not to apply daylight saving time. Configure this setting if the summer time (daylight saving time) is applied in the location where the camera is in use.

- **In:** Applies summer time. An asterisk (\*) will be displayed on the left side of the displayed time and date.
- **Out:** Does not apply summer time.
- **Auto:** Applies summer time in accordance with the settings for “Start time & date” and “End time & date” (month, week, day of the week, time).
- **Default:** Out

### [Start time & date] [End time & date]

When “Auto” is selected for “Summer time (daylight saving)”, select the time & date for the start time and the end time (month, week, day of the week, time).

### [Camera title on screen display]

Select “On” or “Off” to determine whether or not to display the camera title on the screen. When “On” is selected, the character string entered for “Camera title on screen” will be displayed at the position selected for “Camera title position”.

- **Default:** Off

### [Camera title on screen]

Enter a character string to be displayed on the image.

- **Available number of characters:** 0 - 40 characters
- **Available characters:** 0-9, A-Z, a-z and the following marks.  
! " # \$ % & ' ( ) \* + , - . / : ; = ?
- **Default:** None (blank)

### Note

- “Camera title on screen” can be set with up to 2 lines.

#### [Camera title position]

Select the position where the character string will be displayed on the image.

- **Upper left:** The information will be displayed at the upper left corner of the screen.
- **Lower left:** The information will be displayed at the lower left corner of the screen.
- **Upper center:** The information will be displayed at the upper center of the screen.
- **Lower center:** The information will be displayed at the lower center of the screen.
- **Upper right:** The information will be displayed at the upper right corner of the screen.
- **Lower right:** The information will be displayed at the lower right corner of the screen.
- **Default:** Upper left

#### [OSD] - [Display style]

Select "Transparent" or "Opaque" for "Display style".

- **Transparent:** Date/time and camera title on screen will be displayed with transparent letters.
- **Opaque:** Date/time and camera title on screen will be displayed with opaque letters (white letters on black background).
- **Default:** Transparent

#### Note

- When "Opaque" is selected, the opaque black part may be set wider than the section where date/time and camera title on screen are displayed depending on the character size and number of characters.

#### [OSD] - [Character size]

Select the character size of the date and time as well as text displayed in the image.

- **50%:** Displays in 50% of the standard size.
- **75%:** Displays in 75% of the standard size.
- **100%:** Displays in the standard size.
- **150%:** Displays in 150% of the standard size.
- **200%:** Displays in 200% of the standard size.
- **Default:** 100%

#### **IMPORTANT**

- If the settings for [Date/time position] and [Camera title position] are different, the frame rate may be lower than the specified value.
- If the settings for [Date/time position] and [Camera title position] are different, characters may be displayed incorrectly or overlapped depending on the [Character size] setting and the number of characters used. After completing the settings, confirm the result on the "Live" page.
- If "150%" or "200%" is selected for [Character size], the frame rate may be lower than the specified value.
- Depending on the setting and the numbers of characters used for [Character size], and the setting and image capture size of images, characters may be cut off or hard to read. After completing the settings, confirm the result on the "Live" page.

#### Note

- Even when "50%" or "75%" is set, OSD will be displayed in the standard size (100%) when displaying 640x360, VGA, 320x180 or QVGA images.
- When "On" is selected for "Overlay" of "Detailed setting", "150%" and "200%" are unavailable for [OSD] - [Character size].

#### [Brightness status display]

Select "On" or "Off" to determine whether or not to display the status of brightness on images displayed on the "Live" page when adjusting brightness.

- **Default:** On

**Note**

- The status of brightness will be displayed on the screen only when the brightness is adjusted using the system device.

**[Stabilizer]** (Z1) (Z2) (Z4)

Select “On” or “Off” to determine whether or not to activate the image stabilizer.

Intelligent Zoom Stabilization using a gyro sensor and image vector detection enables correcting low-frequency vibration of the poles caused by wind or fine vibration generated when high magnification is set, and shooting with less blurring can be achieved.

This is not available when “2 mega pixel [16:9](60fps mode)” is selected for “Image capture mode”.

- **Default:** Off

Only use the stabilizer function if the camera is installed in an environment that is subject to frequent vibrations. The stabilizer function can reduce the shaking in images.

Use this function after checking operations when installing the camera.

Do not use the stabilizer function if the camera is installed in an environment that is not subject to vibrations.

If the stabilizer function is used in such a case and there is a moving subject, the stabilizer function will correct the image and this may cause it to appear as if the entire screen is shaking.

**IMPORTANT**

- If “On” is selected for “Stabilizer”, the view angle will become narrower. When “On” is selected, check the view angle at camera installation.
- The stabilizer is not available under the following conditions:
  - During PTZ operation
  - During position refresh
- Depending on the photographic conditions such as in the following situations, images may not be able to be effectively stabilized.
  - When subjects are dark
  - Subjects with short-cycled image shaking, such as mechanical vibration
  - Subjects with large-amplitude image shaking
  - Image/Position setting
- If the settings for “Stabilizer” are changed when the following area settings are configured, the positions of the configured areas may move out of alignment. Configure each area after configuring “Stabilizer” settings.
  - mask area
  - privacy zone
  - VMD area
  - VIQS area

**Note**

- If there is shaking in dark environments, image stabilization can become more effective by using a high-speed shutter setting of “Max. 1/100s” or more for “Maximum shutter”. Configure “Maximum shutter” according to the installation environment.
- When “On” is selected for “Stabilizer”, “Off” will automatically be set for “Super Dynamic(SD)”.
- When “On” is selected for “Stabilizer”, the digital zoom factor will be limited to half.

**[Indicator]**

Determine whether or not to use the following indicators. Select “On” to use the following indicators to check the operational status by lighting them.

- Link indicator (LINK)
- Access indicator (ACT)
- SD MOUNT indicator
- **Default:** On

#### **Note**

- **Link indicator (LINK) (orange):** This indicator will light when communication with the connected device is available.
- **Access indicator (ACT) (green):** This indicator will blink when accessing a network.
- **SD MOUNT indicator (SD MOUNT) (green):** Lights when data can be saved to the SD memory card. It blinks or is off when data cannot be saved to the SD memory card.
  - **Indicator is off:** Indicates “Not use” is selected for SD memory card, or an error occurred for the SD memory card.
  - **Indicator blinks:** Indicates the SD memory card is being recognized or is performing the necessary processing for the SD memory card to be removed.
  - **Indicator lights:** Indicates data can be saved to the SD memory card.

#### **[Audio out]**

Determine whether to use the audio output terminal as output for adjustment monitor.

Audio/Monitor

- **Default:** Audio

#### **Note**

- When “Audio out” is set to “Audio”, “Monitor out” cannot be selected.
- When “Audio transmission mode” is set to anything other than “Off” or “Mic input”, “Audio out” cannot be set to “Monitor”.
- When “Audio out” is set to “Monitor”, “Audio transmission mode” can only be set to “Off” or “Mic input”.

#### **[Monitor out]**

Set the image format for images output from the image output terminal (MONITOR OUT terminal).

NTSC/PAL

- **Default:** NTSC

#### **Note**

- The setting of [Monitor out] can be edited only when 30fps mode/60fps mode/15fps mode is selected for “Image capture mode”.
- Output images may sometimes be displayed upside-down.

## 3.5.2 Configure the settings relating to the SD memory card [SD memory card]

Click the [SD memory card] tab on the “Basic” page. (→“3.2.1 How to display the setup menu”, “3.2.2 How to operate the setup menu”)

The settings relating to the SD memory card can be configured on this page.

### Operating mode

#### [SD memory card]

Select “Use” or “Not use” to determine whether or not to use the SD memory card.

- **Default:** Use

#### Note

- When “16:9 mode(60fps mode)” or “16:9 mode(50fps mode)” is selected for “Image capture mode”, functions related to SD memory cards are not available. “Not use” will be selected for “SD memory card”.

#### [Ext. software mode] **S613xx** **S653xx**

Set this setting to “On” when the installed extension software uses the SD memory card in this product.

- **On:** The extension software can use the SD memory card in this product.
- **Off:** The extension software cannot use the SD memory card in this product.
- **Default:** Off

#### Note

- For further information about the extension software, refer to our technical information website <Control No.: C0103>.
- When changing the setting of the extension software mode from “On” to “Off”, it is recommended to format the SD memory card.
- When running an extension software that uses an SD memory card, operation of recording to the SD memory card cannot be guaranteed.

#### [Audio recording]

Select whether or not to save audio data when saving video data in MP4 format.

- **Off:** Does not save audio data to videos (MP4 format).
- **On:** Saves audio data to videos (MP4 format).
- **Default:** Off

#### Note

- When “Audio recording” is used, it is necessary to set either of “Stream(1)”, “Stream(2)”, “Stream(3)” or “Stream(4)” for “Recording format”.

#### [Remaining capacity notification]

When the E-mail notification function or the TCP alarm notification function is used to provide notification of the remaining capacity of the SD memory card, select a level to be notified at from the following.

50%/ 20%/ 10%/ 5%/ 2%

- **Default:** 50%

#### Note

- Notification will be provided each time the remaining capacity goes below each of the specified values.

### 3 Detailed settings

---

For example, notification will be provided each time the remaining capacity reaches 50%, 20%, 10%, 5% and 2% when “50%” is selected. Notification may not always be made at the very moment when the remaining capacity of the SD memory card has reached each value.

#### [Overwrite]

Determine whether or not to overwrite when the remaining capacity of the SD memory card becomes insufficient.

- **On:** Overwrites when the remaining capacity of the SD memory card becomes insufficient. (The oldest image is the first to be overwritten.)
- **Off:** Stops saving images on the SD memory card when the SD memory card becomes full.
- **Default:** On

#### **IMPORTANT**

- Select “Not use” when operating without an SD memory card.
- Before removing the SD memory card from the camera, it is necessary to select “Not use” first. The recorded data may be corrupted if the SD memory card is removed when “Use” is selected.
- When an SD memory card is inserted when “Use” is selected, data will be saved in accordance with the setting of “Save trigger”.
- After inserting the SD memory card, it is necessary to select “Use” to use the SD memory card.
- When the image refresh interval is short, notification/recording timing or interval may become incorrect. Notification/recording may also not be performed correctly as configured when multiple users are receiving images. In this case, set the refresh interval longer.
- There are limited times to overwrite on an SD memory card. When having a high frequency of overwriting, the lifetime of the SD memory card may become shorter.
- A lifetime of an SD memory card should be influenced by the number of the image files stored and log savings on the SD memory card. Selecting “Stream(1)”, “Stream(2)”, “Stream(3)”, or “Stream(4)” for “Recording format” can reduce the number of files that can be stored on the SD memory card.
- If the data writing speed goes down after data is repeatedly written on an SD memory card, we recommend replacing the SD memory card.
- When the setting is changed from “Off” to “On”, if the remaining capacity of the SD memory card is low, old images may be deleted in order to prepare to save new images.

## SD memory card security

#### [Additional info for detecting alteration]

Select whether or not to add information to enable detection when the data in the SD memory card is altered. Alteration detection supports video data (MP4 format) only and can be checked using exclusive software.

For further information about exclusive software for alteration detection and how to use it, refer to our technical information website <Control No.: C0304>.

Click the [Setup>>] button to display the setup menu that can configure the settings relating to additional info for detecting alteration. The setup menu will be displayed in a newly opened window. (→“3.5.3 Configure the settings relating to alteration detection [Alteration detection]”)

#### [SD memory card password lock]

Configure a password for the SD memory card. When configuring a password, devices other than the camera will be unable to write to or read the SD memory card. If the SD memory card is stolen or lost, the risk of recorded data being leaked can be reduced.

#### [Set]

When an SD memory card with no configured password is inserted, a password can be configured using the [Set] button.

**[Password]/[Retype password]**

Enter the password.

**Available number of characters:** 4 - 16 characters

**Unavailable characters:** " &

**Default:** None (blank)

**[Remove]**

When an SD memory card with a configured password is inserted, the password can be removed using the [Remove] button.

**[Password]**

Enter the password.

**Available number of characters:** 4 - 16 characters

**Unavailable characters:** " &

**[Change]**

When an SD memory card with a configured password is inserted, the password can be changed using the [Change] button.

**[Old password]/[New password]/[Retype new password]**

Enter the password.

**Available number of characters:** 4 - 16 characters

**Unavailable characters:** " &

**[Status]**

Display the configuration status of the password lock.

- **Lock:** A password is configured on the SD memory card, and the lock function is enabled.
- **Unlock:** The lock function is disabled.

Also display the password configuration status of SD memory card respectively.

- **Password is set.:** The password is configured correctly.
- **Error(Unsupported SD memory card):** A card that does not support password lock is inserted. Check that an SDHC memory card or SDXC memory card is inserted.
- **Error(Password mismatch):** The SD memory card cannot be used because the password configured for the SD memory card and the password configured for the camera do not match. Check that the passwords are correct.
- **Error(Undefined error):** Displayed when an error occurs in the SD memory card. Check the SD memory card.

**Note**

- The password lock function supports only SDHC memory cards and SDXC memory cards.
- If you will use the SD memory card on a device other than the camera with password lock configured, remove the password using the password lock remove button before removing the SD memory card. The password cannot be removed on devices (such as PCs) other than the camera.
- When the "Status" of "SD memory card password lock" is "Lock", if an SD memory card with noconfigured password is inserted, the password is automatically configured to the SD memory card.

**IMPORTANT**

- If you forget the configured password, the password cannot be removed. The SD memory card with the configured password will become unusable, so manage passwords with great care.
- If you forget the configured password and you want to replace the SD memory card with a new one, perform one of the following step to set the "Status" of "SD memory card password lock" to "Unlock" before replacing the SD memory card.
  - Use the password lock remove button to enter a password and then press the [Set] button.

- Initialize settings from the “Maintenance” page.

## Recording stream

### [Recording format]

Select the type of image data to be recorded on the SD memory card.

- **Off:** Does not record the image data.
- **JPEG(1):** Records still image data (JPEG(1)). The data is recorded in accordance with the settings of “JPEG(1)” on the [Image] tab of the “Image/Audio” page.
- **JPEG(2):** Records still image data (JPEG(2)). The data is recorded in accordance with the settings of “JPEG(2)” on the [Image] tab of the “Image/Audio” page.
- **Stream(1):** Records video data (Stream(1)) in the MP4 video encoding format. The data is recorded in accordance with the settings of “Stream(1)” on the [Image] tab of the “Image/Audio” page.
- **Stream(2):** Records video data (Stream(2)) in the MP4 video encoding format. The data is recorded in accordance with the settings of “Stream(2)” on the [Image] tab of the “Image/Audio” page.
- **Stream(3):** Records video data (Stream(3)) in the MP4 video encoding format. The data is recorded in accordance with the settings of “Stream(3)” on the [Image] tab of the “Image/Audio” page.
- **Stream(4):** Records video data (Stream(4)) in the MP4 video encoding format. The data is recorded in accordance with the settings of “Stream(4)” on the [Image] tab of the “Image/Audio” page.
- **Default:** JPEG(2)

### IMPORTANT

- If an SD memory card with an SD Speed Class other than 10 is used, set the bit rate of a stream selected in “Recording format” to 6 Mbps.
- If an SD memory card with an SD Speed Class 10 is used, set the bit rate of a stream selected in “Recording format” to 12 Mbps.
- For SD memory cards with an SD Speed Class 10, use a card that supports UHS-I. (Ultra High Speed-I)
- Use a microSD memory card dedicated to i-PRO cameras.

### Note

- When “Stream(1)” is selected, the settings for “Stream(1)” on the [Image] tab of the “Image/Audio” page will be changed to the settings for “Stream(1) & recording”.  
When “Stream(2)” is selected, the settings for “Stream(2)” on the [Image] tab of the “Image/Audio” page will be changed to the settings for “Stream(2) & recording”.  
When “Stream(3)” is selected, the settings for “Stream(3)” on the [Image] tab of the “Image/Audio” page will be changed to the settings for “Stream(3) & recording”.  
When “Stream(4)” is selected, the settings for “Stream(4)” on the [Image] tab of the “Image/Audio” page will be changed to the settings for “Stream(4) & recording”.
- When “Stream(1)”, “Stream(2)”, “Stream(3)”, or “Stream(4)” is selected for “Recording format”, the settings of the following functions may be corrected.
  - When “Best effort” is selected for “Transmission priority”, “Frame rate” is set.
  - When “2s”, “3s”, “4s” or “5s” is selected for “Refresh interval”, “1s” is set.
- When “On” is selected for “Additional info for detecting alteration”, “Recording format” cannot be changed to “JPEG(1)” or “JPEG(2)”.
- When “Stream(1)”, “Stream(2)”, “Stream(3)”, or “Stream(4)” is selected for “Recording format”, the name of the saved file will be given automatically.
- When “Stream(1)”, “Stream(2)”, “Stream(3)”, or “Stream(4)” is selected for “Recording format”, the number of users that can access the camera may be reduced.
- When “On” is selected for “Audio recording”, the maximum value of the available bit rate for “Stream” will be limited.



- When “On” is selected for “Additional info for detecting alteration”, the maximum value of the available bit rate for “Stream” will be limited.

### [Save trigger]

Select a trigger to save images on the SD memory card from the following.

- FTP/SFTP periodic image transmission error:** Saves images when images have failed to transmit to the FTP/SFTP server by the FTP/SFTP periodic image transmission function. Available only for “JPEG(1)” and “JPEG(2)”.
- Alarm input:** Saves images at an alarm occurrence.
- Manual:** Saves images manually.
- Schedule:** Saves images in accordance with the settings for “Schedule” (→“3.12 Configure the settings relating to the schedules [Schedule]”). Available only for the “Stream(1)”, “Stream(2)”, “Stream(3)”, or “Stream(4)” images.
- Default:** Manual

If you have selected “Alarm input” in the [Save trigger], you can select the alarm type from the following:

- Terminal 1:** Save the image when an alarm occurs in Terminal 1.
- Terminal 2:** Save the image when an alarm occurs in Terminal 2.
- Terminal 3:** Save the image when an alarm occurs in Terminal 3.
- VMD:** Save the image when motion detection occurs.
- SCD:** Save the image when SCD occurs.
- Auto track** **S613xx** **S653xx**: Saves an image when an auto track occurs.
- Command alarm:** Save the image when a command alarm is entered.

### Note

- When “Stream(1)”, “Stream(2)”, “Stream(3)”, or “Stream(4)” is selected for “Recording format”, “FTP/SFTP periodic image transmission error” is unavailable.
- To enable alarms to occur, alarm settings must be configured in advance on the [Alarm] tab.
- When “JPEG(1)” or “JPEG(2)” is selected for “Recording format”, “Schedule” is unavailable.
- When connected with our network disk recorder, “Save trigger” may be displayed in a gray-out state as “Network failure”. To change the setting of “Save trigger” after disconnecting the recorder, set “Not use” for “SD memory card” once and then set “Use” again.
- Alarm recording is not available for streams that are being distributed in a state where “Advanced(Fixed GOP 60s w/1s key-frame)” is selected for “GOP control”.
- No image will be recorded at the time of an audio detection alarm occurrence.

## JPEG recording(Manual)

JPEG recording(Manual)	
File name	img_
Image saving interval	1fps

This setting is only available when “JPEG(1)” or “JPEG(2)” is selected for “Recording format”, and “Manual” is selected for “Save trigger”.

### [File name]

Enter the file name used for the image to be saved on the SD memory card. The file name will be as follows.

- File name:** [“Entered file name” + “Time and date (year/ month/ day/ hour/ minute/ second)”] + “Serial number”
- Available number of characters:** 1 - 8 characters
- Unavailable characters:** " & \* / : ; < > ? \ |

### 3 Detailed settings

#### [Image saving interval]

When “Manual” is selected for “Save trigger”, select an interval (frame rate) of saving images on the SD memory card from the following.

- When 30fps mode or 15fps mode is selected for [Image capture mode]:  
0.1fps/ 0.2fps/ 0.33fps/ 0.5fps/ 1fps
- When 25fps mode or 12.5fps mode is selected for [Image capture mode]:  
0.08fps/ 0.17fps/ 0.28fps/ 0.42fps/ 1fps
- **Default:** 1fps

## JPEG recording(Alarm)

JPEG recording(Alarm)		
File name	img_	
Image saving interval/Number of images to be saved(Pre alarm)	Image saving interval 1fps	Number of images to be saved Off
Image saving interval/Number of images to be saved(Post alarm)	Image saving interval 1fps	Number of images to be saved 100 pics

This setting is only available when “JPEG(1)” or “JPEG(2)” is selected for “Recording format”, and “Alarm input” is selected for “Save trigger”.

#### [File name]

Enter the file name used for the image to be saved on the SD memory card. The file name will be as follows.

- **File name:** [“Entered file name” + “Time and date (year/ month/ day/ hour/ minute/ second)”] + “Serial number”
- **Available number of characters:** 1 - 8 characters
- **Unavailable characters:** " & \* / : ; < > ? \ |

#### [Image saving interval/Number of images to be saved(Pre alarm)] - [Image saving interval]

When “Alarm input” is selected for “Save trigger”, select a pre alarm interval (frame rate) of saving images on the SD memory card from the following.

- When 30fps mode or 15fps mode is selected for [Image capture mode]:  
0.1fps/ 0.2fps/ 0.33fps/ 0.5fps/ 1fps
- When 25fps mode or 12.5fps mode is selected for [Image capture mode]:  
0.08fps/ 0.17fps/ 0.28fps/ 0.42fps/ 1fps
- **Default:** 1fps

#### [Image saving interval/Number of images to be saved(Pre alarm)] - [Number of images to be saved]

Select a number of pre alarm images to be saved on the SD memory card from the following.

Off/ 1pic/ 2pics/ 3pics/ 4pics/ 5pics

- **Default:** Off

#### [Image saving interval/Number of images to be saved(Post alarm)] - [Image saving interval]

When “Alarm input” or “Manual” is selected for “Save trigger”, select an interval (frame rate) of saving images on the SD memory card from the following.

- When 30fps mode or 15fps mode is selected for [Image capture mode]:  
0.1fps/ 0.2fps/ 0.33fps/ 0.5fps/ 1fps
- When 25fps mode or 12.5fps mode is selected for [Image capture mode]:  
0.08fps/ 0.17fps/ 0.28fps/ 0.42fps/ 1fps
- **Default:** 1fps

### [Image saving interval/Number of images to be saved(Post alarm)] - [Number of images to be saved]

Select a number of alarm images to be saved on the SD memory card from the following.

10pics/ 20pics/ 30pics/ 50pics/ 100pics/ 200pics/ 300pics/ 500pics/ 1000pics/ 2000pics/ 3000pics

- **Default:** 100pics

## Stream recording (Alarm)

Stream recording(Alarm)	
Pre alarm (recording) duration	Off ▼
Post alarm (recording) duration	30s ▼

This setting is only available when “Stream(1)”, “Stream(2)”, “Stream(3)”, or “Stream(4)” is selected for “Recording format” of the SD memory card, and “Alarm input” is selected for “Save trigger”.

### [Pre alarm (recording) duration]

Determine whether or not to perform the pre alarm recording. Set the duration to save image data on the SD memory card.

Off/ 1s/ 2s/ 3s/ 4s/ 5s/ 8s/ 10s/ 15s/ 20s/ 25s/ 30s/ 40s/ 50s/ 60s/ 90s/ 120s

- **Default:** Off

#### **Note**

- The available values change depending on the bit rate and image capture size for “Stream” selected for recording. As the selected bit rate increases, the available maximum value for the pre alarm duration decreases.

### [Post alarm (recording) duration]

Set the duration to save image data on the SD memory card after an alarm occurrence.

10s/ 20s/ 30s/ 40s/ 50s/ 60s/ 120s/ 180s/ 240s/ 300s

- **Default:** 30s

\* The actual recording time may sometimes be longer than the duration selected for this setting.

## SD memory card information

### [Remaining capacity]

Total capacity and remaining capacity of the SD memory card will be displayed.

Depending on the status of the SD memory card, the size indications will differ as follows.

Indication	Description
-----MB/-----MB	No SD memory card is inserted. Failed to obtain available capacity due to error, etc.
*****MB/*****MB	The SD memory card is unformatted.
#####MB/#####MB	The SD memory card password lock cannot be unlocked.

#### **Note**

- When “Off” is selected for “Overwrite” and the available size of the SD memory card is “0 MB”, images will not be saved on the SD memory card. When the notification function is on, a notification will be sent to the registered addresses and destinations of the TCP alarm notification when the SD memory

### 3 Detailed settings

---

card becomes full. (→“3.9.4.2 Configure settings relating to alarm E-mail notifications”, “3.9.10 Configuration of the settings relating to alarm notification [Notification]”)

#### **[Format]**

To format the SD memory card, click the [Execute] button.

#### **IMPORTANT**

- Before formatting the SD memory card, it is necessary to select “Use” for “SD memory card” on the [SD memory card] tab of the “Basic” page. (→“3.5.2 Configure the settings relating to the SD memory card [SD memory card]”)
- Use the SD memory card after formatting it using the [SD memory card] tab. If using the SD memory card that has not been formatted on the [SD memory card] tab, the following functions may not work correctly.
  - Save/obtain alarm images
  - Save/obtain images saved manually
  - Save/obtain images in accordance with the schedule settings
  - Save/obtain images recorded using the SD memory recording function of our network disk recorder
  - Play/download images on the SD memory card
- When an SD memory card is formatted while another user is in operation, the operation will be canceled.
- It is impossible to access the SD memory card during the process of formatting.
- All data saved on the SD memory card will be deleted when the SD memory card is formatted.
- Do not turn off the power of the camera during the process of formatting.
- After formatting the SD memory card, available size may be smaller than the total size since the default directory is automatically created in the SD memory card.
- Use a microSD memory card dedicated to i-PRO cameras.
- When repeatedly recording images on an SD memory card using the auto overwrite function, make sure to use an SD memory card with high reliability and durability.
- Use the SD memory card that complies with UHS-1(Ultra High Speed-1) in the case of SD Speed Class10.

### 3.5.3 Configure the settings relating to alteration detection

#### [Alteration detection]

Selecting “Alteration detection” enables detection using exclusive software when the data on the SD memory card is altered.

Alteration detection supports video files (MP4 format) only.

For how to configure the alteration detection, refer to the video clip <Control No.: P0001> on the support video page on our support website.

For further information about exclusive software for alteration detection and how to use it, refer to our technical information website <Control No.: C0304>.

#### Note

- When “Alteration detection” is used, it is necessary to set either of “Stream(1)”, “Stream(2)”, “Stream(3)” or “Stream(4)” for “Recording format”.

Alteration detection	
Select certificate	Pre-installed ▾
Additional info for detecting alteration	<input type="radio"/> On <input checked="" type="radio"/> Off
Set	
Pre-installed certificate	
Certificate download	Execute
CA Certificate	
CRT key generate	Execute
Generate Certificate Signing Request	Execute
CA Certificate install	<input type="button" value="Choose File"/> No file chosen <input type="button" value="Execute"/>
Information	Invalid <input type="button" value="Confirm"/> <input type="button" value="Delete"/>
Certificate download	Execute
Close	

#### [Select certificate]

Select the certificate to be used with alteration detection.

**Pre-installed:** Selects a pre-installed certificate.

**CA:** Selects a “CA Certificate”. Only displayed when the “CA Certificate” is installed.

**Default:** Pre-installed

#### [Additional info for detecting alteration]

Select whether or not to give information for alteration detection to video files (MP4 format) to be saved on the SD memory card.

#### Note

- When “JPEG(1)” or “JPEG(2)” is selected for “Recording format” of “Recording stream”, “On” cannot be selected.

#### **[Pre-installed certificate - Certificate download]**

Click the [Execute] button and download the root certificate for the pre-installed certificate. When implementing alteration detection of video data (MP4 files) on the SD memory card using exclusive software, the downloaded certificate is used.

#### **[CA Certificate - CRT key generate]**

CRT key (encryption key) used for alteration detection is generated. To generate the CRT key, click the [Execute] button to display “CRT key generate” dialog box.

#### **[CA Certificate - Generate Certificate Signing Request]**

When using the CA certificate issued by CA as the CA certificate used for alteration detection, the CSR (Certificate Signing Request) will be generated.

To generate the CSR, click the [Execute] button to display the “CA Certificate - Generate Certificate Signing Request” dialog window.

#### **[CA Certificate - Certificate install]**

Installs the certificate (CA certificate) issued by CA and displays the information of the installed certificate (CA certificate).

To install the certificate (CA certificate), click the [Choose File] button to display the [Open] dialog box, and select the file of the certificate (CA certificate) issued by CA, and click the [Execute] button.

If the certificate (CA certificate) is already installed, the file name of the installed certificate will be displayed.

#### **[CA Certificate - Information]**

Displays the information of the certificate (CA certificate) issued by CA.

When the [Confirm] button is clicked, the registered information of the installed certificate (CA certificate) will be displayed in the “CA Certificate - Confirm” dialog box.

When the [Delete] button is clicked, the installed certificate (CA certificate) will be deleted.

#### **[CA Certificate - Certificate download]**

Downloads the certificate (CA certificate) issued by CA from the camera.

When implementing alteration detection of video data (MP4 files) on the SD memory card using exclusive software, the downloaded certificate is used.

#### **IMPORTANT**

- Before deleting the valid certificate (CA certificate), confirm that there is a backup file of the certificate (CA certificate) on the PC or another media. The backup file will be required when installing the certificate (CA certificate) again.

### 3.5.4 How to configure alteration detection settings

For how to configure the alteration detection, refer to the video clip <Control No.: P0001> on the support video page on our support website.

### 3.5.5 Configure the overlay image function [Overlay image]

The overlay image function is a function that superimposes an image uploaded to the camera onto a live image and display it as an overlaid image.

Click the [Overlay image] tab on the “Basic” page. (→For menu display and how to operate, refer to “3.2.1 How to display the setup menu”, “3.2.2 How to operate the setup menu”)

The settings relating to the overlay image function can be configured on this page.

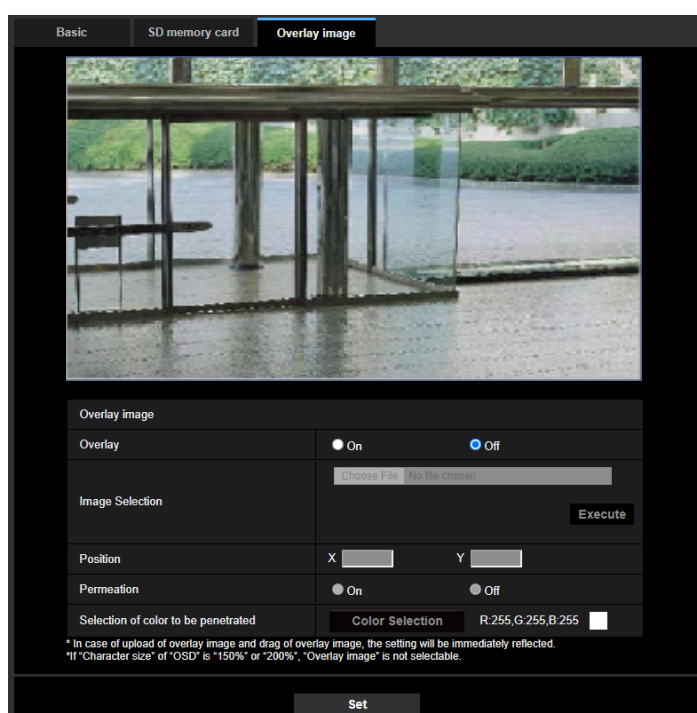

#### [Overlay]

Select “On” or “Off” to determine whether to display an uploaded image overlaid.

**On:** Displays uploaded an image overlaid.

**Off:** Does not display uploaded an image overlaid.

**Default:** Off

#### **IMPORTANT**

- When “On” is set for [Overlay], an overlaid image will be recorded during the SD memory card recording.

#### **Note**

- If “Character size” of “OSD” is “150%” or “200%”, “Overlay image” is not selectable.
- Overlaid images will not be output to the MONITOR OUT terminal.

#### [Image Selection]

Upload an image file to be overlaid to the camera in the following procedure.

- 1) Click the [Choose File] button and select an image file saved on the PC.

### 3 Detailed settings

2) Click the [Execute] button to upload the selected image to the camera.  
When the image is uploaded, the uploaded image will be displayed overlaid on the display.

Image files with the following specification are available for the overlay display.

- Image format: 8-bit bitmap (BMP: Windows format)
- Image size: 24 pixels×24 pixels - 512 pixels×512 pixels
- File size: 257 KB or less

#### Note

- Save image files in a folder whose name does not contain a space or two-bytes code. An image saved in a folder whose name contains a space or two-bytes code may not be uploaded.

#### IMPORTANT

- Do not turn off the power of the camera or operate the camera during uploading of an image file.
- The uploaded image to be displayed will be reduced in size depending on the resolution of live image. Since the uploaded image could sometimes be displayed with low image quality, check the live image page if images are displayed overlaid.
- The images to be uploaded will be saved when they are uploaded.

#### [Position]

The display position of the uploaded image (upper left corner of the image) will be displayed with [X] and [Y] coordinates.



\*1 In case that [16:9] is set for [Image capture mode] When [4:3] is set for [Image capture mode], [Y] will be "479"

There are following two methods to change the display position of the uploaded image.

- Drag and drop the currently displayed uploaded image using the mouse.
- Enter coordinates to [X] and [Y] and then click the [Set] button.

#### Available numbers:

- When "16:9 mode" is selected for "Image capture mode"  
X: 0 – (639 minus the horizontal length of the uploaded image)  
Y: 0 – (359 minus the vertical length of the uploaded image)



- When “4:3 mode” is selected for “Image capture mode”  
X: 0 – (639 minus the horizontal length of the uploaded image)  
Y: 0 – (479 minus the vertical length of the uploaded image)

**Default:** Center of live image

#### **Note**

- A red frame indicating the display position will be displayed during dragging of the uploaded image.
- Coordinates that make the uploaded image out of the setting screen are unavailable to set.
- When an uploaded image is moved by mouse operation, the display position will be saved even if the [Set] button is not clicked.
- If an uploaded image is moved to the edge of the screen, there may be a gap between the image and the screen edge.

#### **IMPORTANT**

- After changing the settings of [Image capture mode] or [Image rotation], check the display position of the uploaded image. When the display position is deviated, configure the display position setting again. If the uploaded image is to be displayed out of the setup screen, the initial display position (center of the live image) will be restored.

#### **[Permeation]**

Select “On” or “Off” to determine whether the color selected at [Selection of color to be penetrated] is to be transparent.

**On:** Gives transparency to the color selected at [Selection of color to be penetrated].

**Off:** Does not give transparency to the color.

**Default:** Off

#### **[Selection of color to be penetrated]**

Select a color to be penetrated in the following procedure.

- 1) Click the [Color Selection] button. A sub window displaying the uploaded image will be displayed.
- 2) Click a color to be penetrated in the displayed image. The selected color and RGB values will be displayed.
- 3) Click the [Close] button to close the sub window.
- 4) Click the [Set] button lastly. The selected color will be penetrated.



## 3.6 Configure the settings relating to images and audio [Image/Audio]

The settings relating to JPEG, H.265, and H.264 images such as the settings of image quality, audio, etc. can be configured on this page.

The “Image/Audio” page has the [Image] tab, the [Image quality] tab, and the [Audio] tab.

### 3.6.1 Configure the settings relating to the image capture mode [Image]

Click the [Image] tab on the “Image/Audio” page. (→“3.2.1 How to display the setup menu”, “3.2.2 How to operate the setup menu”)

#### [Image capture mode]

<WV-S65300 series> <WV-S61300 series> <WV-U65300 series> <WV-U61300 series>

16:9 mode(30fps mode)/ 16:9 mode(25fps mode)/ 16:9 mode(60fps mode)/ 16:9 mode(50fps mode)/ 4:3 mode(15fps mode)/ 4:3 mode(12.5fps mode)/ 4:3 mode(30fps mode)/ 4:3 mode(25fps mode)

<WV-S65501-Z1> <WV-S61501-Z1>

16:9 mode(30fps mode)/ 16:9 mode(25fps mode)/ 4:3 mode(30fps mode)/ 4:3 mode(25fps mode)

#### Default:

16:9 mode(30fps mode)

#### **IMPORTANT**

- The positions of areas may move out of alignment when the “Image capture mode” setting is changed when the following area settings are configured. Therefore we recommend that you configure each area setting after configuring the “Image capture mode”.
  - mask area (→3.6.4.2 Set mask areas)
  - privacy zone (→3.6.4.3 Configure the settings relating to the privacy zone (“Privacy zone” setup menu))
  - VMD area (→3.9.6 Set the VMD areas [VMD area])
  - SCD area (→3.9.8 Set the SCD areas [SCD area])
  - VIQS area (→3.6.4.5 Configure the VIQS area)
  - Overlay image (→3.5.5 Configure the overlay image function [Overlay image])
- Functions of the extension software and the auto track are unavailable when “16:9 mode(60fps mode)”, “16:9 mode(50fps mode)”, “4:3 mode(15fps mode)” or “4:3 mode(12.5fps mode)” is selected for [Image capture mode]. **S613xx** **S653xx**

#### **Note**

- When “2 mega pixel [16:9](60fps mode)” is selected, 60 fps transmission may not be available for the multiple stream transmission and the image may be intermittently displayed. Also, when the audio is simultaneously transmitted, 30 fps transmission will be applied.
- When “VIQS Area” is enabled, and the setting value for the aspect ratio is changed from “4:3” to “16:9”, make sure that the VIQS setting value does not exceed the maximum designated range.

## 3.6.2 Configure the settings relating to JPEG images [Image]

Click the [Image] tab on the “Image/Audio” page. (→“3.2.1 How to display the setup menu”, “3.2.2 How to operate the setup menu”)

### “Live” page (Initial display)

Configure the settings relating to the initial images displayed on the “Live” page.

#### [Initial display stream]

Select the image to display on the “Live” page from the following.

JPEG(1)/JPEG(2)/Stream(1)/Stream(2)/Stream(3)/Stream(4)/Multi-screen

- **Default:**

Stream(1) <WV-S65300 series> <WV-S61300 series> <WV-U65300 series> <WV-U61300 series>

Stream(2) <WV-S65501-Z1> <WV-S61501-Z1>

#### Note

- When “JPEG(1)” or “JPEG(2)” is selected, the refresh interval can be selected.  
MJPEG/Refresh interval: 1s/Refresh interval: 3s/Refresh interval: 5s/Refresh interval: 10s/Refresh interval: 30s/Refresh interval: 60s
- “Stream(1)”, “Stream(2)”, “Stream(3)” or “Stream(4)” is available, when “On” is selected for [Stream transmission].

#### [Refresh interval (JPEG)\*]

Select an interval to refresh the displayed JPEG image from the following.

- When “16:9 mode(30fps mode)”, “16:9 mode(60fps mode)” or “4:3 mode(30fps mode)” is selected for “Image capture mode”:

0.1fps/ 0.2fps/ 0.33fps/ 0.5fps/ 1fps/ 2fps/ 3fps/ 5fps/ 6fps/ 10fps\*/ 12fps\*/ 15fps\*/ 30fps\*

- When “16:9 mode(25fps mode)”, “16:9 mode(50fps mode)” or “4:3 mode(25fps mode)” is selected for “Image capture mode”:

0.08fps/ 0.17fps/ 0.28fps/ 0.42fps/ 1fps/ 2.1fps/ 3.1fps/ 4.2fps/ 5fps\*/ 8.3fps\*/ 12.5fps\*/ 25fps\*

- When “4:3 mode(15fps mode)” is selected for “Image capture mode”:

0.1fps/ 0.2fps/ 0.33fps/ 0.5fps/ 1fps/ 2fps/ 3fps/ 5fps/ 6fps/ 10fps\*/ 12fps\*/ 15fps\*

- When “4:3 mode(12.5fps mode)” is selected for “Image capture mode”:

0.08fps/ 0.17fps/ 0.28fps/ 0.42fps/ 1fps/ 2.1fps/ 3.1fps/ 4.2fps/ 5fps\*/ 8.3fps\*/ 12.5fps\*

- **Default:**

5fps <WV-S65300 series> <WV-S61300 series> <WV-U65300 series> <WV-U61300 series>

1fps <WV-S65501-Z1> <WV-S61501-Z1>

#### Note

- When “On” is selected for “Stream transmission”, the refresh interval may be longer than the set value when any value with an asterisk (\*) on the right is selected.
- Depending on factors such as the network environment, the resolution, the image quality, or the number of computers concurrently accessing the camera, the transmission interval may be longer than the set value.
- If images are not delivered in the specified transmission interval, you can make the images be delivered closer to the specified time by lowering the resolution or image quality.

## JPEG

Configure the settings such as “Image capture size”, “Image quality” of “JPEG(1)” and “JPEG(2)” on this section. Refer to 3.6.3 Configure the settings relating to Stream [Image] for further information about the settings relating to H.265 (or H.264) images.

#### [Image capture size]

Select the image capture size to display the JPEG image.

##### <WV-S65300 series> <WV-S61300 series> <WV-U65300 series> <WV-U61300 series>

- When “16:9 mode(30fps mode)”, “16:9 mode(60fps mode)”, “16:9 mode(25fps mode)”, or “16:9 mode(50fps mode)” is selected for “Image capture mode”:  
JPEG(1): 1920x1080, 1280x720, 640x360, 320x180  
JPEG(2): 640x360 fixed
  - **Default:** 1920x1080
- When “4:3 mode(30fps mode)” or “4:3 mode(25fps mode)” is selected for “Image capture mode”:  
JPEG(1): 1280x960, VGA, QVGA  
JPEG(2): VGA fixed
  - **Default:** 1280x960
- When “4:3 mode(15fps mode)” or “4:3 mode(12.5fps mode)” is selected for “Image capture mode”:  
JPEG(1): 2048x1536, 1280x960, VGA, QVGA  
JPEG(2): VGA fixed
  - **Default:** 2048x1536

##### <WV-S65501-Z1> <WV-S61501-Z1>

- JPEG(1): Only the same image capture sizes set for “Stream(1)”, “Stream(2)”, “Stream(3)”, “Stream(4)” and “JPEG(2)” are selectable.
- JPEG(2): 640x360 fixed (16:9 mode), VGA fixed (4:3 mode)
- **Default:** 2560x1440

When either of the following combination is set, the image capture size of JPEG(2) will be “1280x720”.

##### <WV-S65501-Z1> <WV-S61501-Z1>

- Stream(2): 1920x1080, Stream(3): 1280x720, Stream(4): 320x180
- Stream(2): 1920x1080, Stream(3): 320x180, Stream(4): 1280x720

#### [Image quality]

Select the image quality of JPEG images for each image capture size.

0 Super fine/ 1 Fine/ 2/ 3/ 4/ 5 Normal/ 6/ 7/ 8/ 9 Low

- **Default:** 5 Normal

### 3.6.3 Configure the settings relating to Stream [Image]

Click the [Image] tab on the “Image/Audio” page. (→“3.2.1 How to display the setup menu”, “3.2.2 How to operate the setup menu”)

Configure the settings relating to H.265 (or H.264) image such as “Max bit rate (per client)”, “Image capture size”, “Image quality”, etc. in this section. Refer to “3.6.2 Configure the settings relating to JPEG images [Image]” for the settings relating to JPEG images.

#### Stream(1)/ Stream(2)/ Stream(3)/ Stream(4)

##### [Stream transmission]

Select “On” or “Off” to determine whether or not to transmit H.265 (or H.264) images.

- **On:** Transmits H.265 (or H.264) images.
- **Off:** Does not transmit H.265 (or H.264) images.
- **Default:** On

##### Note

- When “On” is selected for “Stream transmission” in “Stream(1)”, “Stream(2)”, “Stream(3)”, or “Stream(4)” displaying of H.265 (or H.264) images or JPEG images on the “Live” page will become available.
- When “On” is selected for “Stream transmission” for “Stream(1)”, “Stream(2)”, “Stream(3)”, or “Stream(4)”, the refresh interval of JPEG images is limited to a maximum of 5 fps (30fps mode/ 60fps mode/ 15fps mode) or 4.2 fps (25fps mode/ 50fps mode/ 12.5fps mode).

##### [Stream encoding format]

Select the stream encoding format for transmission.

- **H.265:** Transmits H.265 images.
- **H.264:** Transmits H.264 images.
- **Default:** H.265

##### [Image capture size]

Select the image capture size from the following. What can be selected may be limited depending on the image capture size already selected.

**<WV-S65300 series> <WV-S61300 series> <WV-U65300 series> <WV-U61300 series>**

When “16:9 mode(30fps mode)”, “16:9 mode(60fps mode)”, “16:9 mode(25fps mode)”, or “16:9 mode(50fps mode)” is selected for “Image capture mode”:

Stream(1)	Stream(2)	Stream(3)	Stream(4)
1920x1080	1920x1080	1280x720	640x360
1280x720	1280x720	640x360	320x180
640x360	640x360	320x180	
320x180	320x180		

When “4:3 mode(30fps mode)” or “4:3 mode(25fps mode)” is selected for “Image capture mode”:

Stream(1)	Stream(2)	Stream(3)	Stream(4)
1280x960	1280x960	VGA	VGA
VGA	VGA	QVGA	QVGA
QVGA	QVGA		

When “4:3 mode(15fps mode)” or “4:3 mode(12.5fps mode)” is selected for “Image capture mode”:

### 3 Detailed settings

Stream(1)	Stream(2)	Stream(3)	Stream(4)
2048x1536 (Fixed)	1280x960 VGA QVGA	VGA QVGA	VGA QVGA

#### <WV-S65501-Z1> <WV-S61501-Z1>

When “16:9 mode(30fps mode)” or “16:9 mode(25fps mode)” is selected for “Image capture mode”:

Stream(1)	Stream(2)	Stream(3)	Stream(4)
3072x1728 2560x1440	3072x1728 2560x1440 1920x1080 1280x720 640x360 320x180	1280x720 640x360 320x180	1280x720 640x360 320x180

When “4:3 mode(30fps mode)” or “4:3 mode(25fps mode)” is selected for “Image capture mode”:

Stream(1)	Stream(2)	Stream(3)	Stream(4)
3072x2304 2560x1920	3072x2304 2560x1920 1280x960 800x600 VGA 400x300 QVGA	VGA QVGA	VGA QVGA

#### [Transmission priority]

Select a transmission priority for “Stream” from the following.

- **Constant bit rate:** H.265 (or H.264) images will be transmitted with the bit rate selected for “Max bit rate (per client)\*”.
- **VBR:** H.265 (or H.264) images will be transmitted with the frame rate selected for “Frame rate\*” while maintaining the image quality level selected in “Image quality”. In this case, images will be transmitted with the bit rate kept within the maximum bit rate that is set for “Max bit rate (per client)\*”. The recording capacity changes according to the “Image quality” setting and conditions of the subject.
- **Frame rate:** H.265 (or H.264) images will be transmitted with the frame rate selected for “Frame rate\*”.
- **Best effort:** In accordance with the network bandwidth, H.265 (or H.264) images will be transmitted with the maximum bit rates that are set for “Max bit rate (per client)\*”.
- **Default:** VBR

#### Note

- When “Frame rate” is set for “Transmission priority”, number of users who can access the camera may be limited.

#### [Frame rate\*]

Select a frame rate from the following.

- When “16:9 mode(30fps mode)”, “16:9 mode(60fps mode)”, “4:3 mode(30fps mode)” or “4:3 mode(15fps mode)” is selected for “Image capture mode”:  
1fps/ 3fps/ 5fps\*/ 7.5fps\*/ 10fps\*/ 12fps\*/ 15fps\*/ 20fps\*/ 30fps\*/ 60fps\*
- When “16:9 mode(25fps mode)”, “16:9 mode(50fps mode)”, “4:3 mode(25fps mode)” or “4:3 mode(12.5fps mode)” is selected for “Image capture mode”:

1fps/ 3.1fps/ 4.2fps\*/ 6.25fps\*/ 8.3fps\*/ 12.5fps\*/ 20fps\*/ 25fps\*/ 50fps\*

- **Default:** 30fps\*

#### Note

- When “3072x1728” or “2560x1440” is selected for “Stream(2)”, the frame rate will be limited to max. “15 fps (“12.5fps\*” in 25fps mode)”. When “1280x720” is selected for “Stream(4)”, the frame rate will also be limited to max. “15 fps (“12.5fps\*” in 25fps mode)”. <WV-S65501-Z1> <WV-S61501-Z1>
- “Frame rate\*” is restricted by “Max bit rate (per client)\*”. For this reason, the frame rate may be lower than the specified value when any value marked with an asterisk (\*) is selected. When “VBR” is selected for “Transmission priority”, depending on the settings of “Max bit rate (per client)\*” and “Image quality”, transmission of images may periodically be paused. Check the transmission of images after changing settings.
- Depending on the number users connecting at the same time or the combination of features used, the frame rate may be lower than the configured value. Check the transmission of images after changing settings.
- When the “Image capture mode” is set as “16:9 mode(60fps mode)”, Stream(1) is fixed to 60fps. Also, Stream(2) to Stream(4) can select up to a maximum of 10fps.
- When the “Image capture mode” is set as “16:9 mode(50fps mode)”, Stream(1) is fixed to 50fps. Also, Stream(2) to Stream(4) can select up to a maximum of 8.3fps.
- When the frame rate is lowered, images may not be displayed normally depending on the web browser in use.

#### [Max bit rate (per client)\*]

Select an H.265 (or H.264) bit rate per a client from the following.

64kbps/ 128kbps\*/ 256kbps\*/ 384kbps\*/ 512kbps\*/ 768kbps\*/ 1024kbps\*/ 1536kbps\*/ 2048kbps\*/ 3072kbps\*/ 4096kbps\*/ 6144kbps\*/ 8192kbps\*/ 10240kbps\*/ 12288kbps\*/ 14336kbps\*/ 16384kbps\*/ 20480kbps\*/ 24576kbps\*/ — FREE ENTRY—

When “— FREE ENTRY—” is selected, the bit rate can be freely entered in the available range.

- **Default:**
  - <WV-S65300 series> <WV-S61300 series> <WV-U65300 series> <WV-U61300 series>
  - Stream(1): 3072kbps\*
  - Stream(2): 2048kbps\*
  - Stream(3): 768kbps\*
  - Stream(4): 768kbps\*
  - <WV-S65501-Z1> <WV-S61501-Z1>
  - Stream(1): 6144kbps\*
  - Stream(2): 3072kbps\*
  - Stream(3): 2048kbps\*
  - Stream(4): 768kbps\*

\* The range of bit rates that can be configured for H.265 (or H.264) bit rates differs depending on the “Transmission priority” and “Image capture size”.

When “Constant bit rate”, “Frame rate”, or “Best effort” is selected for “Transmission priority”

- 320x180, 640x360, QVGA and VGA: 64kbps - 4096kbps\*
- 1280x720<sup>1</sup> and 1280x960: 128kbps\* - 8192kbps\*
- 1920x1080<sup>1</sup>: 256kbps\* - 12288kbps\*
- 2048x1536: 512kbps\* - 16384kbps\*
- 2560x1440: 768kbps\* - 24576kbps\*
- 2560x1920: 768kbps\* - 24576kbps\*
- 3072x1728: 1024kbps\* - 24576kbps\*
- 3072x2304: 1536kbps\* - 24576kbps\*

When “VBR” is selected for “Transmission priority”

### 3 Detailed settings

---

- 320×180, 640×360, QVGA, and VGA: 64kbps - 12288kbps\*
- 1280×720<sup>1</sup> and 1280×960: 128kbps\* - 12288kbps\*
- 1920×1080<sup>1</sup>: 256kbps\* - 24576kbps\*
- 2048×1536: 512kbps\* - 24576kbps\*
- 2560×1440: 768kbps\* - 24576kbps\*
- 2560×1920: 768kbps\* - 24576kbps\*
- 3072×1728: 1024kbps\* - 24576kbps\*
- 3072×2304: 1536kbps\* - 24576kbps\*

#### **Note**

- The bit rate for “Stream” is restricted by “Bandwidth control(bit rate)” on the [Network] tab on the “Network” page (→“3.11.1 Configure the network settings [Network]”). When a value with “\*” attached is set, images may not be streamed.
- It is recommend that the bit rate setting of the stream to be 8192 kbps or lower. Setting a value higher than 8192 kbps may cause abnormalities in the continuity of the recorded video.
- When the refresh interval is too short, the actual bit rate may exceed the set bit rate depending on the subject.
- Depending on the number users connecting at the same time or the combination of features used, the bit rate may be lower than the configured value. Check the transmission of images after changing settings.

#### **[Image quality]**

Select the image quality of H.265 images from the following.

- **For “Constant bit rate”, “Frame rate”, and “Best effort”:** Low(Motion priority)/ Normal/ Fine(Image quality priority)
- **“VBR”:** 0 Super fine/ 1 Fine/ 2/ 3/ 4/ 5 Normal/ 6/ 7/ 8/ 9 Low
- **Default:** 5 Normal

#### **[Smart Coding] - [Smart VIQS]** **S613xx** **S653xx**

Maintains high image quality in the areas containing heads, people, cars, and motorcycles and low or medium image quality in other areas while reducing the transmission data volume.

- **Off:** Does not use “Smart VIQS”.
- **On(High):** Maintains high image quality in the areas containing heads, people, cars, and motorcycles and low image quality in other areas while reducing the transmission data volume.
- **On(Low):** Maintains high image quality in the areas containing heads, people, cars, and motorcycles and medium image quality in other areas while reducing the transmission data volume.
- **Default:** On(Low)

#### **Note**

- This feature can only be used for “Stream(1)”. If “On(High)” or “On(Low)” is selected, the VIQS setting from the [Image quality] tab is disabled.

#### **[Smart Coding] - [Auto VIQS]** **U613xx** **U653xx**

Maintains high image quality in the areas of the image containing moving objects and reduces the transmission data volume in other areas of the image.

- **Off:** Does not use “Auto VIQS”
- **On:** Maintains high image quality in the areas of the image containing moving objects, and reduces the transmission data volume in other areas of the image.
- **Default:** Off

#### **Note**

- This feature can only be used for “Stream(1)”.



- If “Auto VIQS” is “On”, the VIQS setting from the [Image] tab is disabled.

### [Smart Coding] - [Smart P-picture control] **S613xx** **S653xx**

Controls the area other than the areas containing heads, people, cars, and motorcycles to be reduced the transmission data volume of P-picture.

- **Off:** Does not use “Smart P-picture control”
- **On:** Controls the area other than the areas containing heads, people, cars, and motorcycles to be reduced the transmission data volume of P-picture.
- **Default:** Off

#### **Note**

- This feature can only be used for “Stream(1)”. If “On” is selected, the VIQS setting from the [Image quality] tab is disabled.
- When “On” is selected, on non-detected area, movement may not be smooth or noise appears.

### [Smart Coding] - [GOP control]

By using “GOP control”, the transmission data volume can be reduced.

- **When “H.265” is selected as the “Stream encoding format”:** Off/ Low(Variable GOP 1s-8s)/ Mid(Variable GOP 4s-16s)/ Advanced(Fixed GOP 60s w/1s key-frame)/ Frame rate control(Variable GOP 4s-16s w/frame rate control)
- **When “H.264” is selected as the “Stream encoding format”:** Off/ Low(Variable GOP 1s-8s)/ Mid(Variable GOP 4s-16s)
- **Default:** Off

### **IMPORTANT**

- When “Low(Variable GOP 1s-8s)”, “Mid(Variable GOP 4s-16s)”, or “Frame rate control(Variable GOP 4s-16s w/frame rate control)” is selected, recording to an SD memory card cannot be performed.

#### **Note**

- When using “GOP control”, the refresh interval is increased when streaming H.265 (or H.264) images. For this reason, do not use it when the network environment has frequent errors.
- “Low(Variable GOP 1s-8s)”/“Mid(Variable GOP 4s-16s)”/“Frame rate control(Variable GOP 4s-16s w/ frame rate control)” can be selected only when “VBR” is selected for “Transmission priority”. “Advanced(Fixed GOP 60s w/1s key-frame)” can be selected regardless of the “Transmission priority” setting.
- By using “Low(Variable GOP 1s-8s)”/“Mid(Variable GOP 4s-16s)”/“Frame rate control(Variable GOP 4s-16s w/frame rate control)”, the transmission data volume can be reduced when there is no target to be detected (people’s face, body, vehicle and two-wheel vehicle) in the image. By using “Advanced(Fixed GOP 60s w/1s key-frame)”, the transmission data volume can be reduced regardless of presence/absence of target to be detected in the image.
- When “Frame rate control(Variable GOP 4s-16s w/frame rate control)” is selected, the frame rate will change within the range between 1fps and a value set in [Frame rate\*] according to presence/absence of target to be detected.
- When “Frame rate control(Variable GOP 4s-16s w/frame rate control)” is selected, the display may temporarily become slower or faster when changing frame rates.

### [Refresh interval]

Select an interval (I-frame interval; 0.2 - 5 seconds) to refresh the displayed H.265 (or H.264) images from the following.

If using under a network environment with frequent error occurrences, shorten the refresh interval for H.265 (or H.264) to diminish image distortions. However, the refresh interval may become longer than the set value or the actual bit rate may exceed the set bit rate.

0.2s/ 0.25s/ 0.33s/ 0.5s/ 1s/ 2s/ 3s/ 4s/ 5s

- **Default:** 2s

#### **Note**

- When “Low(Variable GOP 1s-8s)” is selected for “GOP control”, the refresh interval is set to Max. 8s.
- When “Mid(Variable GOP 4s-16s)” is selected for “GOP control”, the refresh interval is set to Max. 16s.
- When “Advanced(Fixed GOP 60s w/1s key-frame)” is selected for “GOP control”, the refresh interval is set to 60s.
- If “GOP control” is set to “Frame rate control(Variable GOP 4s-16s w/frame rate control)”, the frame rate ranges from 1fps to the value set in [Frame rate\*] depending on the size of image changes. The smaller the frame rate value, the longer the refresh interval. When the frame rate is the value set in [Frame rate\*], the refresh interval is at Max. 16s.

#### **[Transmission type]**

Select the transmission type of H.265 (or H.264) images from the following.

- **Unicast port (AUTO):** Up to 14 users can access a single camera concurrently. “Unicast port1(Image)” and “Unicast port2(Audio)” will automatically be selected when transmitting images and audio from the camera. When it is unnecessary to fix the port number for stream transmission such as when using in a particular LAN environment, it is recommended to select “Unicast port (AUTO)”.
- **Unicast port (MANUAL):** Up to 14 users can access a single camera concurrently. It is necessary to select “Unicast port1(Image)” and “Unicast port2(Audio)” manually to transmit images and audio from the camera. When “Unicast port (MANUAL)” is selected, the port number will automatically be assigned at the time of accessing the camera using a web browser. However, it is possible to fix the port number of the router used for stream transmission via the Internet by setting “Unicast port (MANUAL)” (→“3.11.1 Configure the network settings [Network]”). Refer to the operating instructions of the router in use.
- **Multicast:** Unlimited number of users can access a single camera concurrently. Complete the entry field of “Multicast address”, “Multicast port” and “Multicast TTL/HOPLimit” when transmitting stream with multicast.  
\* Refer to “1.1.1 Monitor images from a single camera” for further information about the maximum concurrent access number.
- **Default:** Unicast port (AUTO)

#### **Note**

- When multicast is set, H.265 (or H.264) images cannot be monitored using a browser.

#### **[Unicast port1(Image)]<sup>2</sup>**

Enter the unicast port number (used to transmit images from the camera).

- **Available port number:** 1024 - 50000 (Only even numbers are available.)
- **Default:**
  - Stream(1): 32004
  - Stream(2): 32014
  - Stream(3): 32024
  - Stream(4): 32034

#### **[Unicast port2(Audio)]<sup>2</sup>**

Enter the unicast port number (used to transmit audio from the camera).

- **Available port number:** 1024 - 50000 (Only even numbers are available.)
- **Default:**
  - Stream(1): 33004
  - Stream(2): 33014
  - Stream(3): 33024
  - Stream(4): 33034

**[Multicast address]<sup>\*3</sup>**

Enter the multicast IP address. Images and audio will be transmitted to the designated IP address.

- **Available IPv4 address:** 224.0.0.0 - 239.255.255.255
- **Available IPv6 address:** Multicast address starting with "FF"
- **Default:**
  - Stream(1): 239.192.0.20
  - Stream(2): 239.192.0.21
  - Stream(3): 239.192.0.22
  - Stream(4): 239.192.0.23

**Note**

- Enter a multicast IP address after checking available multicast address.

**[Multicast port]<sup>\*3</sup>**

Enter the multicast port number (used to transmit images from the camera).

- **Available port number:** 1024 - 50000 (Only even numbers are available.)
- **Default:** 37004

**Note**

- When audio is transmitted from the unit, the port number to be used will be the multicast port number plus "1000".

**[Multicast TTL/HOPLimit]<sup>\*3</sup>**

Enter a value for "Multicast TTL/HOPLimit".

- **Available value:** 1-254
- **Default:** 16

**IMPORTANT**

- When transmitting stream images via the internet, the transmitted image sometimes may not be displayed depending on the settings of a proxy server or a firewall. In this case, refer to the network administrator.
- When two or more network interface cards are installed on the PC in use, the network interface card(s) not used for receiving images should be invalidated when displaying images using the multicast port.

---

<sup>\*1</sup> When 60fps or 50fps is used, settings up to 24576kbps are possible.

<sup>\*2</sup> It is necessary to designate the unicast port number when "Unicast port (MANUAL)" is selected for "Transmission type".

<sup>\*3</sup> It is necessary to designate the multicast IP address when "Multicast" is selected for "Transmission type".

### 3.6.4 Configure the settings relating to image adjust, privacy zone, and VIQS [Image quality]

Click the [Image quality] tab on the “Image/Audio” page. (→“3.2.1 How to display the setup menu”, “3.2.2 How to operate the setup menu”)

When the [Setup>>] button of each setting item is clicked, the detailed settings menu will be displayed in a newly opened window. The detailed settings can be configured while monitoring images displayed on the [Image quality] tab.

The settings relating to the image adjust, privacy zone, and VIQS can be configured on this page.

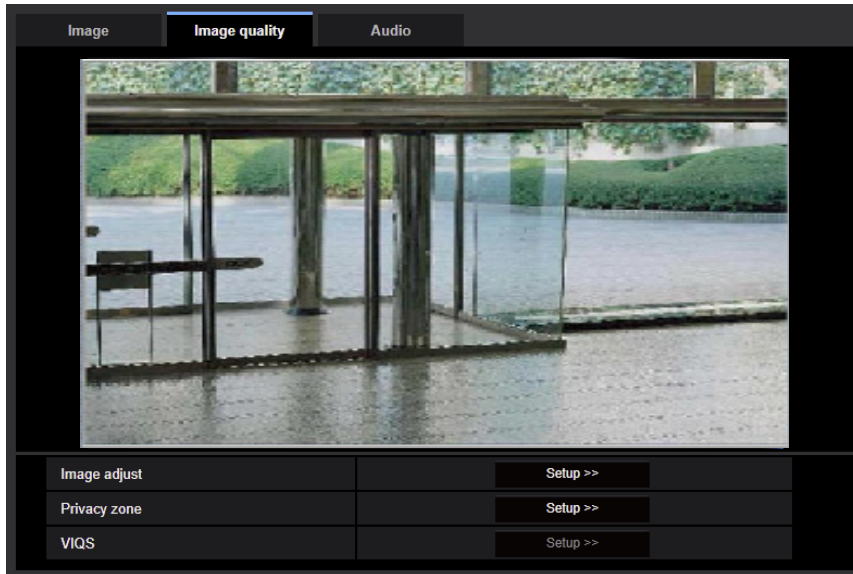

#### [Image adjust]

Click the [Setup>>] button to display the setup menu that can configure the settings relating to image quality. The setup menu will be displayed in a newly opened window. (→“3.6.4.1 Configure the settings relating to image quality (“Image adjust” setup menu)”)

#### [Privacy zone]

Click the [Setup>>] button to display the setup menu that can configure the settings relating to the privacy zone. (→“3.6.4.3 Configure the settings relating to the privacy zone (“Privacy zone” setup menu)”)

#### [VIQS]

Click the [Setup>>] button to display the setup menu that can configure the settings relating to VIQS. (→“3.6.4.5 Configure the VIQS area”)

#### 3.6.4.1 Configure the settings relating to image quality (“Image adjust” setup menu)

Click the [Setup>>] button of “Image adjust” on the [Image quality] tab of the “Image/Audio” page. (→“3.6.4 Configure the settings relating to image adjust, privacy zone, and VIQS [Image quality]”)

The settings relating to image quality can be configured with the setup menu displayed in a newly displayed window. When the values are changed, the changed values will be applied to the currently displayed image on the [Image quality] tab.

Click the “+” mark on the left of each item in the setup menu to expand the respective item, and enable detailed settings.

Click the “-” mark on the left of an expanded item to return to the screen displayed before the item was expanded.

#### <Example: Basic adjustment>

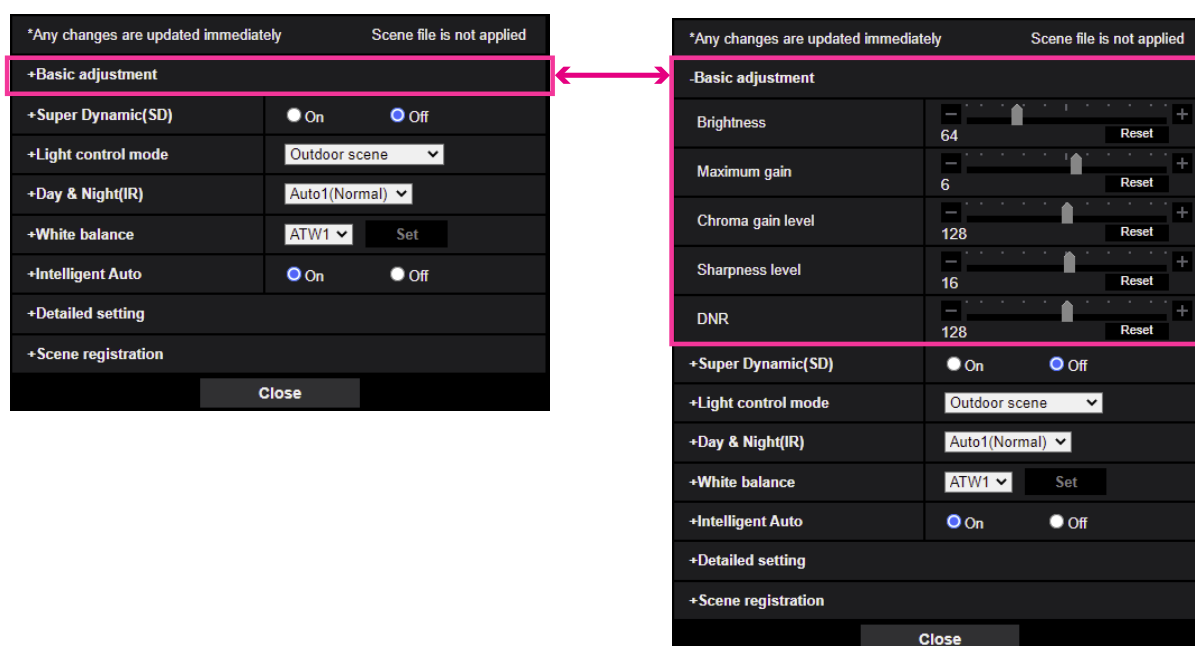

## Basic adjustment



### [Brightness]

Adjust the brightness.

If you move the slider in the “+” direction, the image will become brighter.

If you move the slider in the “-” direction, the image will become darker.

Click the [Reset] button to reset to the default brightness setting.

- **Default:** 64

### [Maximum gain]

Adjusts the maximum gain. When the luminance of the subject becomes darker, gain will be automatically increased and screen will become brighter. If you increase the gain, the noise may also increase.

If you move the slider in the “+” direction, the maximum gain will increase.

If you move the slider in the “-” direction, the maximum gain will decrease.

Click the [Reset] button to reset to the default setting.

- **Default:**

6 <WV-S65300 series> <WV-S61300 series> <WV-U65300 series> <WV-U61300 series>

#### 9 <WV-S65501-Z1> <WV-S61501-Z1>

##### [Chroma gain level]

Adjusts the chroma level (color density).

If you move the slider in the “+” direction, the colors will become loud and vivid. If you move the slider in the “-” direction, the colors will become subdued. Click the [Reset] button to reset the color to the default.

- **Default:** 128

##### [Sharpness level]

Adjust the sharpness level (outline compensation).

If you move the slider in the “+” direction, the outline of the image will become sharper, and if you move it in the “-” direction, the outline of the image will become softer. Click the [Reset] button to reset the color to the default.

- **Default:** 16

##### [DNR]

The digital noise reduction function reduces noise automatically under the condition of low illuminance.

If you move the slider in the “+” direction, the noise reduction effect is strengthened. There may be many afterimages.

If you move the slider in the “-” direction, the noise reduction effect is weakened. There are fewer afterimages. Click the [Reset] button to reset to the default setting.

- **Default:** 128

## Super Dynamic(SD)

##### [Super Dynamic(SD)]

Select “On” or “Off” to determine whether or not to activate the super dynamic function.

This is not available when “Image capture mode” is set to “16:9 mode(60fps mode)” or “16:9 mode(50fps mode)”.

Refer to the description “Super Dynamic function” about the super dynamic function.

- **On:** The super dynamic function will work.
- **Off:** The super dynamic function will not work.
- **Default:** Off

##### Note

- When the following are observed depending on the light condition, select “Off” for “Super Dynamic(SD)”.
  - When flickering appears or the color changes on the screen
  - When noise appears in the brighter area on the screen
- When [Light control mode] is set to “Fix shutter”, [Super Dynamic] cannot be set to “On”.
- When “On” is selected for “Stabilizer”, “Off” will automatically be set for “Super Dynamic(SD)”.

##### [Level]

Adjust the super dynamic (SD) level.

If you move the slider in the “+” direction, a subject with high contrast can be captured without over exposure or under exposure.

If you move the slider in the “-” direction, the parts with medium brightness can be captured with rich gradation. Click the [Reset] button to reset to the default setting.

- **Default:**  
29 <WV-S65300 series> <WV-S61300 series> <WV-U65300 series> <WV-U61300 series>  
27 <WV-S65501-Z1> <WV-S61501-Z1>

**Note**

- When the Super dynamic level is changed between 29 and 30, video distortion may occur.

**Super Dynamic function**

When there is wide variation between the illumination of light and dark areas of the location being monitored, the camera adjusts the lens iris in accordance with the brighter areas. This causes loss of detail in darker areas. Conversely, adjusting the lens brightness for the darker areas causes the brighter areas to become washed out.

Super Dynamic digitally combines an image that is set up for a clear view of the brighter areas with an image that is set up for a clear view of the darker areas, creating a final image that preserves overall detail.

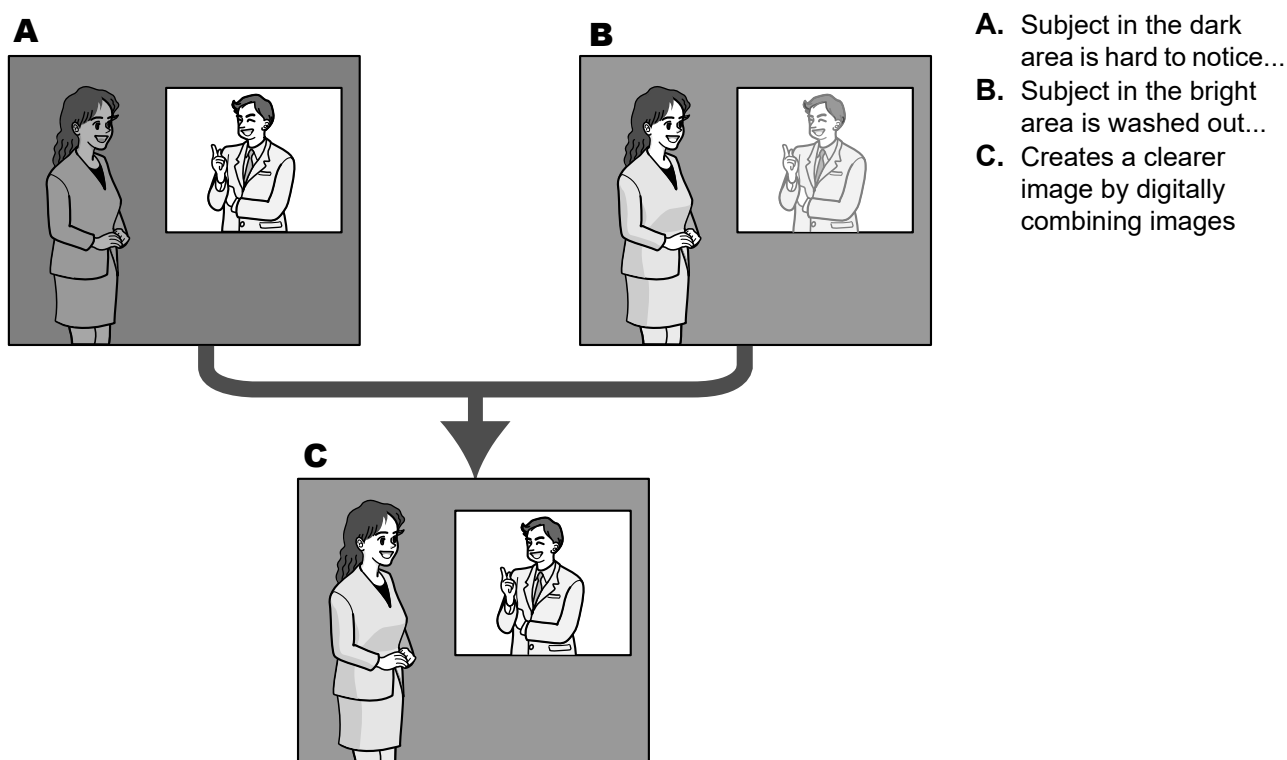
**[BLC/ HLC]**

Select from the following. When “On” is selected for “Super Dynamic(SD)” or when “On” is selected for “Intelligent auto”, this setting is not available.

- **Back light compensation (BLC):** Activates the back light compensation (BLC) function.
- **High light compensation(HLC):** Activates the high light compensation (HLC) function. The high light compensation function limits the over exposure of subjects caused bright light (such as light from headlights of cars) at night.
- **Off:** Deactivates the back light compensation function and high light compensation function.
- **Default:** Off

**[BLC level]**

Adjust the BLC level.

If you move the slider in the “+” direction, the effect of back light compensation will increase.

If you move the slider in the “-” direction, the effect of back light compensation will decrease.

Click the [Reset] button to reset to the default setting.

- **Default:** 16

#### [HLC level]

Adjust the high light compensation level.

If you move the slider in the “+” direction, the effect of high light compensation (HLC) will increase.

If you move the slider in the “-” direction, the effect of high light compensation (HLC) will decrease.

Click the [Reset] button to reset to the default setting.

- **Default:** 16

#### [Mask area]

When mask area is set, the selected area is masked and you can adjust brightness. When “On” is selected for “Super Dynamic(SD)”, this setting is not available.

Refer to “3.6.4.2 Set mask areas” for information on how to set the mask area.

## Light control mode

#### [Light control mode]

Select the light control mode from the following.

- **Outdoor scene:** Depending on the brightness level (illuminance), the iris will automatically be controlled together with the shutter speed adjustment to control light. When shooting a bright subject such as outdoor, etc., select this parameter. Be aware that flicker may occur when a subject is under fluorescent lighting.
- **Indoor scene (50 Hz) / Indoor scene (60 Hz):** The shutter speed will automatically be adjusted to prevent flicker caused by fluorescent light. Select 50 Hz or 60 Hz corresponding to the location where the camera is in use.
- **Fix shutter:**
  - When 30fps mode or 15fps mode is selected for [Image capture mode]:  
1/30 Fix, 3/120 Fix, 2/100 Fix, 2/120 Fix, 1/100 Fix, 1/120 Fix, 1/250 Fix, 1/500 Fix, 1/1000 Fix, 1/2000 Fix, 1/4000 Fix, 1/10000 Fix
  - When 25fps mode or 12.5fps mode is selected for [Image capture mode]:  
1/25 Fix, 3/100 Fix, 2/100 Fix, 1/100 Fix, 1/250 Fix, 1/500 Fix, 1/1000 Fix, 1/2000 Fix, 1/4000 Fix, 1/10000 Fix
  - When 60fps mode is selected for [Image capture mode]:  
1/60 Fix, 1/100 Fix, 1/120 Fix, 1/250 Fix, 1/500 Fix, 1/1000 Fix, 1/2000 Fix, 1/4000 Fix, 1/10000 Fix
  - When 50fps mode is selected for [Image capture mode]:  
1/50 Fix, 1/100 Fix, 1/250 Fix, 1/500 Fix, 1/1000 Fix, 1/2000 Fix, 1/4000 Fix, 1/10000 Fix
- **Default:** Outdoor scene

#### Note

- When a faster shutter speed is selected (up to 1/10000), it is possible to capture a fast moving object with less blur.
- When a faster shutter speed is selected, the sensitivity will become lower.
- When “On” is selected for “Super Dynamic(SD)”, “Fix shutter” is not available. To configure “Fix shutter”, set “Super Dynamic(SD)” to “Off”.
- When 25fps mode, 50fps mode, or 12.5fps mode is selected for “Image capture mode”, “Indoor scene (60 Hz)” is not available.

#### [Maximum shutter]

The maximum shutter time adjusts the storage time of the sensor. The following are available for the recording duration.

- When 30fps mode or 15fps mode is selected for [Image capture mode]:  
Max.1/4000s, Max.1/2000s, Max.1/1000s, Max.1/500s, Max.1/250s, Max.1/120s, Max.1/100s, Max.2/120s, Max.2/100s, Max.3/120s, Max.1/30s, Max.2/30s, Max.4/30s, Max.6/30s, Max.10/30s, Max.16/30s
- When 25fps mode or 12.5fps mode is selected for [Image capture mode]:



Max.1/4000s, Max.1/2000s, Max.1/1000s, Max.1/500s, Max.1/250s, Max.1/100s, Max.2/100s, Max.3/100s, Max.1/25s, Max.2/25s, Max.4/25s, Max.6/25s, Max.10/25s, Max.16/25s

- **Default:** Max.1/30s

#### **Note**

- When “On” is selected for “Super Dynamic(SD)”, “Max.1/2000s” and “Max.1/4000s” are not available.
- When “0” is selected for “Maximum gain”, the setting of “Maximum shutter” will be restricted as follows:
  - When 30fps mode, 60fps mode or 15fps mode is selected for [Image capture mode]: “Max.2/30s” or higher is not available.
  - When 25fps mode, 50fps mode or 12.5fps mode is selected for [Image capture mode]: “Max.2/25s” or higher is not available.
- When “Light control mode” is set to “Indoor scene (60 Hz)”, a shorter time than “Max. 1/120s” cannot be set.
- When “Light control mode” is set to “Indoor scene (50 Hz)”, a shorter time than “Max. 1/100s” cannot be set.

#### **[Light control speed]**

Adjust the light control speed.

If you move the slider in the “+” direction, the light control speed will increase.

If you move the slider in the “-” direction, the light control speed will decrease.

Click the [Reset] button to reset to the default setting.

- **Default:** 31

## **Day & Night(IR)**

#### **[Day & Night(IR)]**

Select switching between the color mode and the black & white mode from the following.

- **Off:** The color mode is selected.
- **On:** Always captured as black & white images.
- **Auto1(Normal):** The camera automatically switches between the color mode and the black & white mode in accordance with the picture brightness (luminance).
- **Auto2(IR Light):** The camera automatically switches between the color mode and the black & white mode in accordance with the picture brightness (luminance). Suitable when using near-infrared lighting at night.
- **Auto3(SCC):** Suitable to keep the color mode even under darker light condition. The Super Chroma Compensation (SCC) function retains the color mode even with dim lighting.
- **Default:** Auto1(Normal)

#### **Super Chrome Compensation (SCC) function**

This function achieves faithful color images using the proprietary color compensation technology that reproduce images even under low illumination where it is usually difficult to capture objects faithfully.

#### **Note**

- Since the color compensation technology is used for “Auto3(Super Chrome Compensation(SCC))”, some colors may look different from the actual objects depending on the light condition (such as when infrared lights are used).
- The operating sound might be heard when changing to black-and-white mode, however it does not indicate any malfunction.
- The color mode and the black & white mode may not be switched automatically depending on the environment. In such a case, use the schedule function to switch the color and the black & white mode. For how to set up, refer to our technical information website <Control No.: C0314>.

#### [Level]

Select the threshold illuminance level (brightness) to switch between the color mode and the black & white mode. The following threshold illuminance level is given when a clear dome cover is in use and also "Off" is selected for "Super Dynamic(SD)".

- **3:** Switches from the color mode to the black & white mode when the ambient brightness (luminance) of the camera reaches approx. 8 lx or less.
- **2:** Switches from the color mode to the black & white mode when the ambient brightness (luminance) of the camera reaches approx. 4 lx or less.
- **1:** Switches from the color mode to the black & white mode when the ambient brightness (luminance) of the camera reaches approx. 2 lx or less.
- **0:** Switches from the color mode to the black & white mode when the ambient brightness (luminance) of the camera reaches approx. 1 lx or less.
- **Default:** 1

#### Note

- Switching to the color mode will be made when the ambient brightness of the camera reaches approx. 5 to 8 times of the values above respectively. Depending on the environment, the above operation may vary.
- When a low value is selected for "Maximum gain", it may be difficult to switch modes depending on the environment.

#### [Dwell time]

Select a wait time for switching between the color mode and the black & white mode from the following.

2s/ 10s/ 30s/ 1min

- **Default:** 10s

## White balance

#### [White balance]

Select a method of white balance adjustment from the following.

White color can be adjusted by "Red gain" and "Blue gain".

- **ATW1:** Selects the automatic tracing white balance mode. The camera will constantly check the color temperature of the light source and adjust the white balance automatically. Operating color temperature range is approx. 2,700 K to 6,000 K.
- **ATW2:** Selects the automatic tracing white balance mode under a sodium lamp. The camera will adjust the white balance automatically under a sodium lamp. Operating color temperature range is approx. 2,000 K to 6,000 K.
- **AWC:** Selects the automatic white balance control mode. This adjustment is suitable for a location where a light source is stable. Operating color temperature range is approx. 2,000 K to 10,000 K.
- **Default:** ATW1

#### Note

- Under the following conditions, color may not be faithfully processed. In these cases, select "AWC".
  - When shooting a subject whose major part is a thick color
  - When shooting blue sky or sun at sunset
  - When shooting a subject whose luminance is too low
- When "AWC" is selected, click the [Set] button.

#### [Red gain]

Adjust the red color of images.

When the slider is moved in the "+" direction, the red color will become thicker. When the slider is moved in the "-" direction, the red color will be thinner. Click the [Reset] button to reset the color to the default.

- **Default:** 128

### [Blue gain]

Adjust the blue color of images.

When the slider is moved in the “+” direction, the blue color will become thicker. When the slider is moved in the “-” direction, the blue color will be thinner. Click the [Reset] button to reset the color to the default.

- **Default:** 128

### [Mask area]

If you set the mask area, you can adjust the white balance after masking the set area.

Refer to “3.6.4.2 Set mask areas” for information about how to configure the mask area.

### [Adjustment speed]

Adjust the white balance adjustment speed.

If you move the slider in the “+” direction, the white balance adjustment speed will increase. If you move the slider in the “-” direction, the white balance adjustment speed will decrease. If you click the [Reset] button, the slider position and white balance adjustment speed will be reset to default.

- **Default:** 16

## Intelligent auto

### [Intelligent auto]

Select On/Off to determine whether or not to activate the “Intelligent auto” function.

“Intelligent auto” can detect conditions (back lighting, outdoor, night time, etc.), people's faces and moving objects and then automatically adjust the camera's aperture, gain, shutter speed, and contrast in order to display people's faces and moving objects more clearly.

- **Default:** On

### [Face priority level(Brightness)]

Adjusts the face priority level when “Intelligent auto” is activated.

If you move the slider in the “+” direction, adjusts to improve the visibility of faces.

If you move the slider in the “-” direction, adjusts the entire image so that is well-balanced.

Click the [Reset] button to reset to the default setting.

- **Default:** 128

### [Motion priority level(Shutter)]

Adjusts the motion priority level when “Intelligent auto” is activated.

If you move the slider in the “+” direction, it becomes difficult for the moving subjects to blur, but the noise of dark subjects increases.

If you move the slider in the “-” direction, it becomes easier for the moving subjects to blur, but the noise of dark subjects decreases.

Click the [Reset] button to reset to the default setting.

- **Default:** 128

### Note

- Be aware that flicker may occur due to fluorescent lighting when activating the Intelligent Auto function. In such a case, set either of the following:
  - Move the slider of [Motion priority level(Shutter)] in the “-” direction.
  - Change [Light control mode] to “Indoor scene (50 Hz)” or “Indoor scene (60 Hz)”.
- Be aware that the brightness of the whole image may change due to changes in a part of the object when activating the “Intelligent auto” function. In this case, move the slider of “Face priority level” in the “-” direction.

## Detailed setting

### [Auto contrast adjust]

Select On/Off(Manual) to determine whether or not to activate the auto contrast adjust function.

**On:** Activates the auto contrast adjust function.

**Off:** Stops the auto contrast adjust function.

- **Default:** On

### Note

- When “On” is selected for “Intelligent auto”, this setting is not available.

### [Contrast level]

Adjust the contrast level.

If you move the slider in the “+” direction, the contrast of the image will increase.

If you move the slider in the “-” direction, the contrast of the image will decrease.

Click the [Reset] button to reset to the default setting.

- **Default:** 128

### [Adaptive black stretch]

Adjust the brightness of the dark parts of the image.

If you move the slider in the “+” direction, the dark parts of the image will become brighter.

If you move the slider in the “-” direction, the dark parts of the image will become darker.

Click the [Reset] button to reset to the default setting.

- **Default:** 128

### **IMPORTANT**

- The “Adaptive black stretch” settings may cause the noise in the darker parts to increase, and the parts around borders between the darker parts and the brighter parts may become darker/brighter than the other darker/brighter parts.

### [Adaptive highlight stretch]

Adjust the brightness of the bright parts of the image.

If you move the slider in the “+” direction, the dark parts of the image will become brighter.

If you move the slider in the “-” direction, the bright parts of the image will become darker.

Click the [Reset] button to reset to the default setting.

- **Default:** 128

### [Fog compensation]

Select “On” or “Off” to determine whether or not to activate the fog compensation function. When “On” is selected for “Auto contrast adjust”, or when “On” is selected for “Intelligent auto”, this setting is not available.

The fog compensation function can make dim images that have been affected by fog or other conditions clearer using digital image processing.

- **On:** Activates the fog compensation function.
- **Off:** Stops the fog compensation function.
- **Default:** Off

### [Level]

Adjust the fog compensation level.

The level of fog compensation will increase when the slider is moved in the “+” direction, and decrease when the slider is moved in the “-” direction. Click the [Reset] button to reset to the default setting.

- **Default:** 4

**[Pedestal level]**

Adjust the black level of images by moving the slider.

When the slider is moved to the “+” direction, images will become brighter. When the slider is moved to the “-” direction, images will be darker. Click the [Reset] button to reset the color to the default.

- **Default:** 128

## Scene registration

**[Scene file]**

The combination of settings used to adjust image quality can be saved as a scene file. The scene file can be selected here.

Registered scene files can be configured in the “Schedule” page (→“3.12 Configure the settings relating to the schedules [Schedule]”). If the timing of when images are viewed greatly affects the area where images are viewed, registering scene files to the schedule can let you match a combination of settings to different times of day in order to view images in the best conditions.

**[Scene file title]**

The scene file name (up to 10 characters) displayed in “Scene file” can be changed. Only file names displayed in “1:”, “2:”, “3:”, and “4:” can be changed.

- **Unavailable characters:** " & \

**[Load] button**

Loads the setting data selected in “Scene file” and changes the current image accordingly.

**[Register] button**

The combination of settings used to adjust image quality that are currently displayed can be registered to the scene file displayed in “Scene file”.

### 3.6.4.2 Set mask areas

This explains how to mask an area of the image and adjust brightness.

When setting the mask area, set “Super Dynamic(SD)” to “Off”.

1. Display the “Image adjust” setup menu. (→“3.6.4 Configure the settings relating to image adjust, privacy zone, and VIQS [Image quality]”)

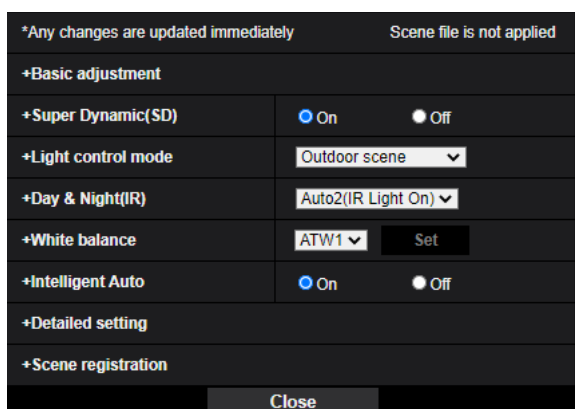

### 3 Detailed settings

2. Click “+” on the left of “Super Dynamic(SD)” to display the detailed SD menu.

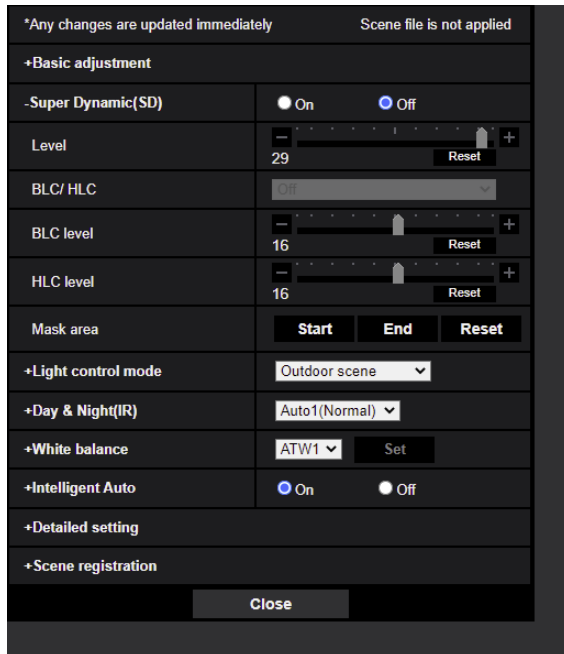

3. Click the [Start] button of “Mask area”.  
→ Borders will appear and the image displayed on the [Image quality] tab will be divided into 48 (8×6).

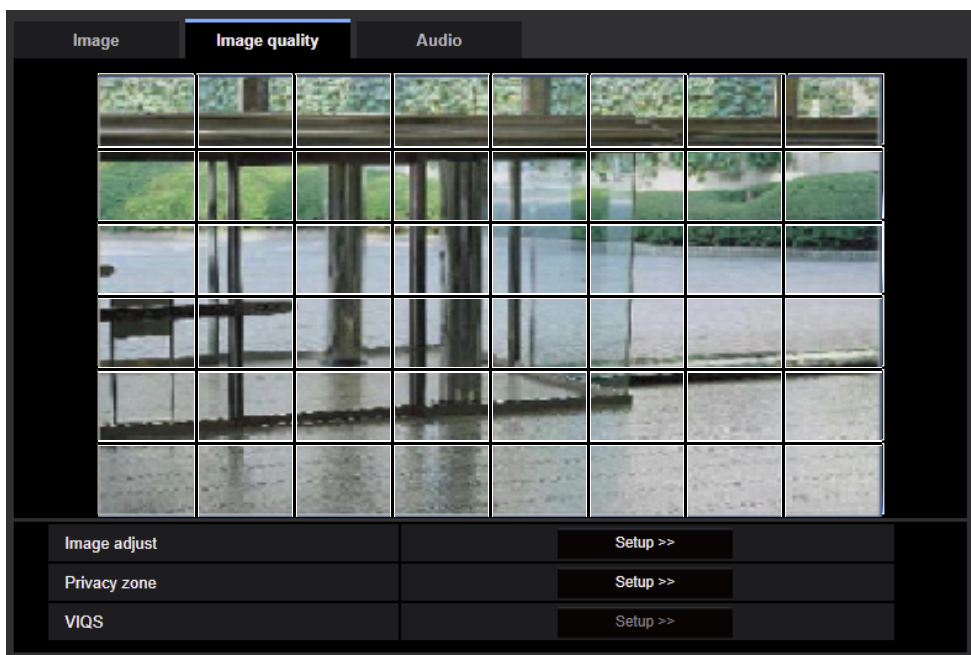

4. Click the divided areas to be masked.

→ The clicked areas will be masked and will become white. To cancel masking, click the area again.

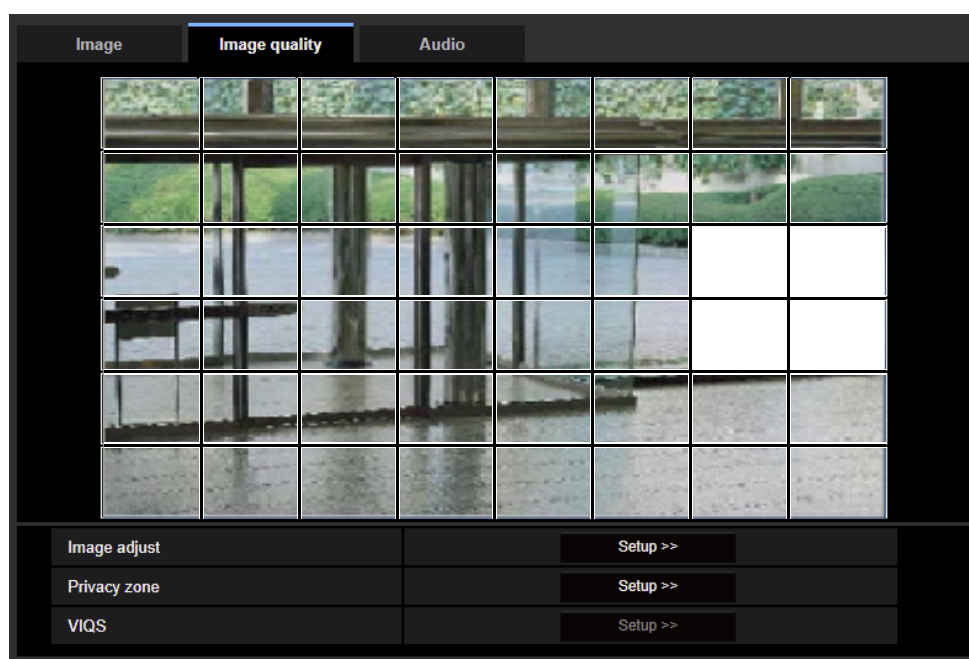

5. Click the [End] button after completing masking areas.

→ The borders on the image displayed on the [Image quality] tab will disappear.

### IMPORTANT

- The mask area may move out of alignment when “Image capture mode” of the [Image] tab is changed. Make sure to check the mask area after changing the “Image capture mode” setting.
- The mask area may move out of alignment when “HD Extra optical zoom” is configured after the mask area is set. Make sure to check the mask area after changing the setting.

### Note

- When the [Reset] button is clicked, masking for all the masked areas will be canceled.

### 3.6.4.3 Configure the settings relating to the privacy zone (“Privacy zone” setup menu)

Click the [Advanced setting] button of “Privacy zone” on the [Image] tab of the “Image/Audio” page.

(→“3.6.4 Configure the settings relating to image adjust, privacy zone, and VIQS [Image quality]”)

When there is a zone that you do not want to display, set the zone as a privacy zone not to be displayed. Up to 32 privacy zones can be set.

You can set the areas by dragging the mouse on the screen.

### Note

- The privacy zone function does not work when the camera is in the process of warming-up just after turning on the power, or in the process of refreshing the position.
- Depending on the panning/tilting direction (especially when the tilting degree is 45° - 90°) and the zooming factor, the area set as the privacy zone may become visible. Make sure that each of the set privacy zone is not visible after setting it.

### 3 Detailed settings

- Reconfigure the privacy zone if the way the camera is fixed is changed.

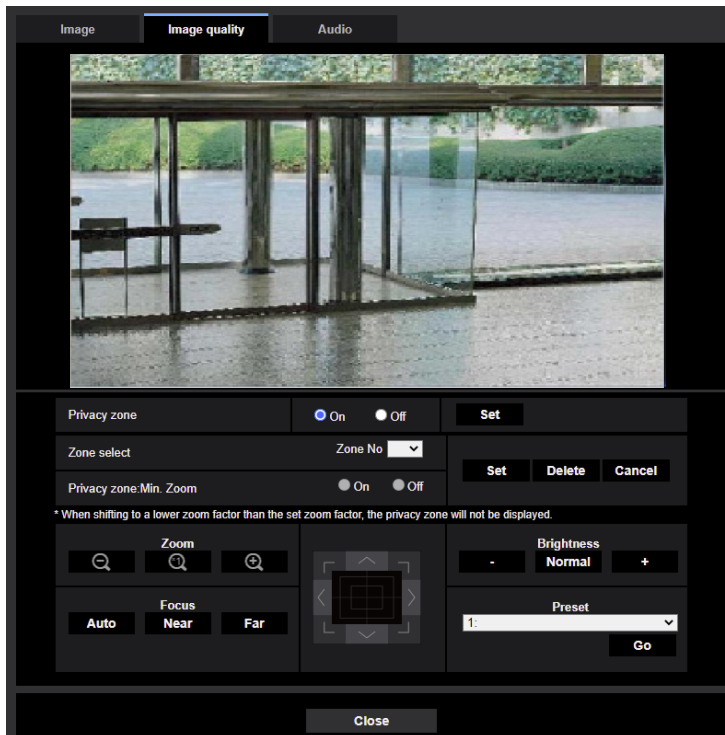

#### [Privacy zone]

Select a display type of the privacy zone from the following.

**On:** Displays in gray.

**Off:** Does not display the privacy zones.

**Default:** On

#### [Zone select]

Click [▼] of “Zone No” and select a zone number from the pull-down menu.

An asterisk (\*) next to the zone number indicates that the privacy zone has already been set for the number.

The privacy zone will be set when an area is designated by dragging the mouse.

Click the [Set] button after determining the position of the camera. In this case, a slightly wider area than was specified will be configured.

To delete the registered zone, click the [Delete] button after designating the desired zone number to be deleted.

Click the [Cancel] button to cancel what was set or deleted.

#### **Note**

- Set the privacy zone larger than the size of an object to be hidden.  
To raise the precision of the privacy zone placement especially when the zoom is on the “Wide” side, it is recommended to set the privacy zone with the zoom range between 1x and 3x.

#### [Privacy zone:Min. Zoom]

Select “On” or “Off” to enable or disable the minimum zoom when displaying images of the privacy zone.

**On:** Saves the current zoom ratio.

**Off:** Does not display the privacy zones. Saves the zoom ratio as x1. The privacy zone will always be displayed regardless of the zoom ratio.

**Default:** Off



**Note**

- When shifting to a lower zoom factor than the set zoom factor, the privacy zone will not be displayed.

**[Zoom] buttons, [Focus] buttons, [Brightness] buttons, Control pad/buttons and [Go] button**

Refer to “1.1.2 About the “Live” page” for descriptions of how to operate these buttons/pad.

**[Close] button**

Click this button to close the “Privacy zone” setup menu.

### 3.6.4.4 Configure the VIQS setting

Click the [Setup>>] button of “VIQS” on the [Image quality] tab of the “Image/Audio” page. (→“3.6.4 Configure the settings relating to image adjust, privacy zone, and VIQS [Image quality]”)

VIQS is an abbreviation of Variable Image Quality on Specified area and is a feature that enables you to change the images of a specified area.

It is possible to enhance the image quality of the specified range within a shooting area (image).

It is also possible to moderate the image data size by lowering the image quality of other areas.

The VIQS setting is available only for H.265 (or H.264) images.

Up to 8 VIQS areas can be set.

To check the image after configuring VIQS, when H.265 (or H.264) images are selected under “Stream”, you can check the image by pressing the [Confirm] button. You can also check by displaying an H.265 (or H.264) image on the “Live” page.

The VIQS function is not available in the following cases:

- When “On(High)” or “On(Low)” is set for “Smart VIQS” of “Stream(1)”
- When “On” is selected for “Smart P-picture control”

## VIQS Area

**[Select a preset position]**

In order to configure a VIQS area, select the preset position number of the VIQS area that you want to configure, and then click the [Start] button.

In order to configure a VIQS area outside of preset areas, select “except the preset positions”.

**[Area]**

When selecting a VIQS area in the screen, it will be numbered as area 1. (Subsequent areas will be numbered in the order of selection.)

**[Center]**

When the [Center] button is clicked, the whole area will become the VIQS area, and “1(White)” will be automatically applied to “Area”.

**[Status]**

Select “On” or “Off” to determine whether or not to use the VIQS area.

- **On:** The VIQS area will be set.
- **Off:** Does not set the VIQS area.
- **Default:** Off

**[Delete] button**

Deletes the VIQS area. Click the button to delete the VIQS area.

### 3 Detailed settings

---

#### [Level]

Configure the difference level in the image quality between specified areas and non-specified areas. The greater the difference level, the more the image quality of the non-specified area is reduced. This makes it possible to moderate the image data size.

0 Min./ 1/ 2/ 3/ 4/ 5 Normal/ 6/ 7/ 8/ 9 Max.

- **Default:** 5 Normal

## Stream

#### [Stream(1)]

Select “On” or “Off” to determine whether or not to activate the VIQS function for the transmitted (Stream(1)) images.

The VIQS (Stream(1)) images can be confirmed with the [Confirm] button.

- **Default:** Off

#### [Stream(2)]

Select “On” or “Off” to determine whether or not to activate the VIQS function for the transmitted (Stream(2)) images.

The VIQS (Stream(2)) images can be confirmed with the [Confirm] button.

- **Default:** Off

#### [Stream(3)]

Select “On” or “Off” to determine whether or not to activate the VIQS function for the transmitted (Stream(3)) images.

The VIQS (Stream(3)) images can be confirmed with the [Confirm] button.

- **Default:** Off

#### [Stream(4)]

Select “On” or “Off” to determine whether or not to activate the VIQS function for the transmitted (Stream(4)) images.

The VIQS (Stream(4)) images can be confirmed with the [Confirm] button.

- **Default:** Off

### **IMPORTANT**

- When the setting for “Upside-down” on the [Basic] tab is changed after setting “On” for the VIQS setting, the VIQS area may move out of alignment. Make sure to check the VIQS setting after changing the “Image capture mode” setting.

#### **Note**

- Refer to “3.6.4.5 Configure the VIQS area” for setting procedure of the VIQS area.
- When “Off” is selected for “Stream transmission” of the applicable stream, the [Confirm] button of the stream selection will become unavailable.

### 3.6.4.5 Configure the VIQS area

The VIQS area is specified by following the steps below.

1. Drag the mouse on the screen to specify the area (up to 8 areas).
  - The specified area is set to area “1(White)”, and the outline is displayed.
  - The areas are set in the area number order from number 1. The color next to the area number show the color of the corresponding outline.

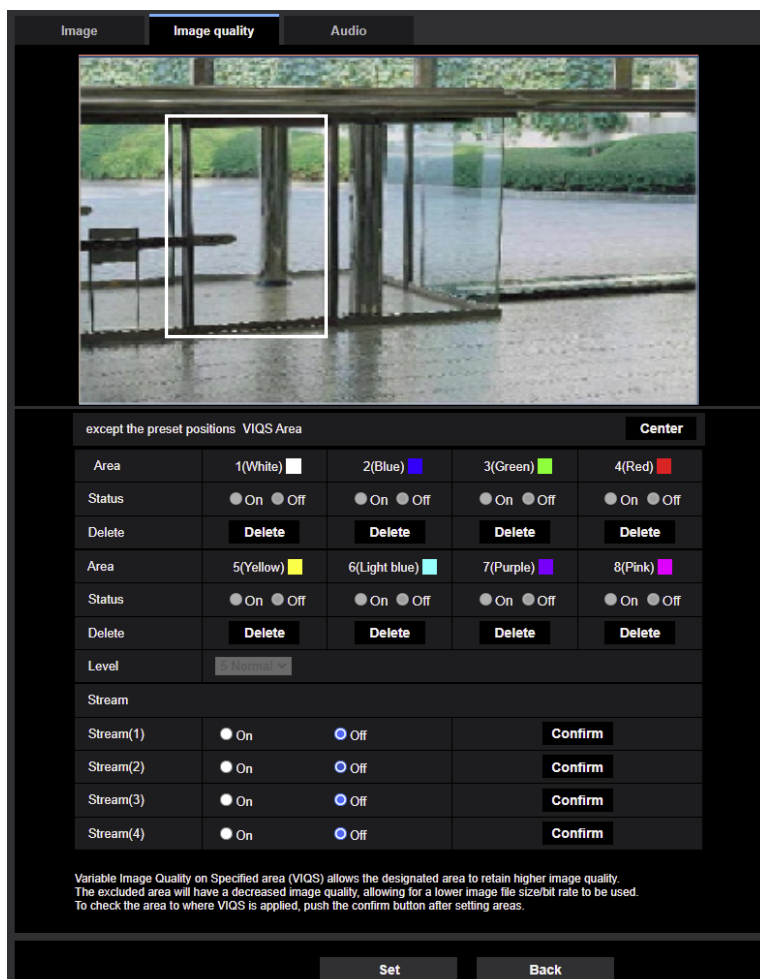

2. Configure the difference level in the image quality between specified areas and non-specified areas. The greater the difference level, the more the image quality of the non-specified area is reduced. This makes it possible to moderate the image data size.
3. Select “On” or “Off” to determine whether or not to activate the VIQS function for the transmitted images of “Stream(1)”- “Stream(4)”.
4. Click the [Set] button.
  - This unit is updated with the setting contents. Click the [Delete] button corresponding to the area to be deleted.
5. Click the [Confirm] button.
  - The image (“Stream(1)” – “Stream(4)”) that the [Confirm] button was pressed for is displayed. When a window is newly opened and about 3 seconds pass, the currently outputted bit rate can be confirmed with the configured VIQS.

#### **IMPORTANT**

- No setting contents are determined unless the [Set] button is clicked.

### 3 Detailed settings

---

- To check the image after configuring VIQS, display an H.265 (or H.264) image on the “Live” page, or press the [Confirm] button under “Stream”.
- The outputted bit rate changes depending on the subject. Confirm the bit rates with actual subjects used when operating the camera.
- If the larger range is specified, the output bit rate increases. Check the current output bit rate to decide the area size.

## 3.6.5 Configure the settings relating to audio [Audio]

Click the [Audio] tab on the “Image/Audio” page. (→“3.2.1 How to display the setup menu”, “3.2.2 How to operate the setup menu”)

The settings relating to audio can be configured on this page.

### Note

- Images and audio will not be synchronized. Therefore, images and audio may not always match.
- Audio may be interrupted depending on the network environment.

## Mic input

### [Mic input volume]

Set the audio volume for input into the camera. This setting is reflected in the volume when listening to audio on a PC (mic input to PC), and in the volume during “Audio recording”.

- **Mic High/Mic Middle/Mic Low:** Set the volume when audio is input to the camera using a microphone.
- **Line High/Line Middle/Line Low:** Set the volume when audio is input to the camera using line input.
- **Default:** Mic Middle

### [AGC (audio)]

Automatically adjusts the audio reception to a suitable volume. The degree to which the volume is adjusted can be selected from High/Middle/Low.

When “High” is selected, it is easier to hear quiet sounds, but sounds may be heard as noise. If you do not want to hear noise, select “Middle” or “Low”. These settings are linked with the volume settings of the “Audio recording”.

- **Default:** High

### [Audio bit rate]

Set the audio compression bit rate.

[G.726(Live)]: 16kbps/32kbps

[G.711(Live)]: 64kbps (cannot be changed)

[AAC-LC(Live/Recording)]: 64kbps/96kbps/128kbps

- **Default:**
  - [G.726(Live)]: 32kbps
  - [AAC-LC(Live/Recording)]: 128kbps

## Audio transmission/reception

### [Audio transmission mode]

Select the communication mode used for audio data transmission/reception between the camera and the PC from the following:

- **Off:** Does not receive/transmit audio between the camera and the PC.
- **Mic Input (To PC):** PC receives the audio data from the camera. On the PC, the image can be viewed together with the accompanying audio. The image and audio are not synchronized.
- **Audio output(From PC):** Transmits audio data from the PC to the camera. Audio can be heard from the speaker connected to the camera.
- **Interactive(Half-duplex):** Both reception and transmission are available. However, audio data cannot simultaneously be transmitted and received.
- **Interactive(Full-duplex):** Both reception and transmission are simultaneously available.
- **Default:** Off

#### **Note**

- Howling may be generated depending on the usage conditions. Prevent sound generated by the PC from entering the PC microphone.
- “Audio recording” is not available when “Interactive(Half-duplex)” is selected for “Audio transmission mode”.
- When using audio output on the “Live” page, access the “Live” page through HTTPS.

#### **[Mic input interval (Camera to PC)]**

Select an interval for audio reception from the following.

20ms/ 40ms/ 80ms/ 160ms

- **Default:** 40ms

#### **Note**

- When a shorter interval is selected, the delay time will be shorter. When a longer interval is selected, audio interruption may be diminished even though the delay time will be longer. Select the interval according to the network environment.
- “Mic input interval (Camera to PC)” is unavailable when “AAC-LC” is selected for “Audio input encoding format”.

#### **[Audio output volume (PC to Camera)]**

Select a volume level on the camera to hear audio transmitted from the PC.

High/ Middle/ Low

- **Default:** Middle

#### **[Audio output interval (PC to Camera)]:**

Select an interval for audio transmission from the following.

160ms/ 320ms/ 640ms/ 1280ms

- **Default:** 640ms

#### **Note**

- When a shorter interval is selected, the delay time will be shorter. When a longer interval is selected, audio interruption may be diminished even though the delay time will be longer. Edit the settings according to the network environment, performance of the PC in use and the usage of applications other than the web browser.
- Audio may temporarily be interrupted and noise may be heard when multiple users are accessing the camera concurrently. It may be possible to diminish the interruption or noise by setting a longer interval for “Audio output interval (PC to Camera)”.
- Audio may sometimes not be heard depending on the network environment.

#### **[Audio output duration]:**

Configure the maximum duration for each time audio is outputted.

1min/ 2min/ 3min/ 5min/ 10min/ 20min/ 30min/ 1h

- **Default:** 5min

#### **Note**

- Audio output stops when the specified time has passed. To turn the audio transmission function on, click the Audio output button again.

#### **[Audio output port (PC to Camera)]:**

Enter the transmission port number (the port number on the camera used to receive audio data transmitted from the PC).

Available port number: 1024-50000 (Only even numbers are available.)

- **Default:** 34004

**Note**

- The transmission port number entered for “Audio output port (PC to Camera)” will be used only when “Unicast port (MANUAL)” is selected for “Transmission type” (→[Transmission type]). When “Off” is selected for “Stream transmission” (→[Stream transmission]) or when “Unicast port (AUTO)” or “Multicast” is selected for “Transmission type”, it is not necessary to enter the transmission port number.

## Live page

**[Audio input encoding format]**

Select the audio input encoding format from G.726, G.711, or AAC-LC.

- **Default:** AAC-LC

**Note**

- Mic input is available only with AAC-LC when using a web browser.
- G.711 is available only when the “Mic Input (To PC)” is selected for “Audio transmission mode”.
- G.726 is always applied for the audio transmission encoding format.

**[Audio volume control mode]**

Select the operation method using the volume cursor of the Mic input button on the “Live” page.

- **Adjust PC speaker:** Change the volume of the PC in which the “Live” page is opened.
- **Adjust Mic input:** Change the mic input volume of the camera.
- **Default:** Adjust Mic input

## 3.7 Configure the settings relating to PTZ [PTZ]

The settings relating to the camera operation, the preset position, and the auto track **S613xx** **S653xx** can be configured on the “PTZ” page.

The “PTZ” page has the [Cam. Function] tab, the [Position] tab, the [Auto track] tab **S613xx** **S653xx** and the [Auto track alarm setting] tab **S613xx** **S653xx**.

### 3.7.1 Configure the settings relating to the camera operations [Cam. Function]

The settings relating to the camera operation can be configured in this section.



Click the [Cam. Function] tab on the “PTZ” page. (→For menu display and how to operate, refer to “3.2.1 How to display the setup menu”, “3.2.2 How to operate the setup menu”)

<WV-S65340-Z4>

Cam. Function	Position	Auto track	Auto track alarm setting
Basic settings			
Home position	Off		
Self return	Off		
Self return time			
Upside-down	<input type="radio"/> On <input checked="" type="radio"/> Off		
Maximum optical zoom ratio			
HD Extra optical zoom	<input checked="" type="radio"/> On <input type="radio"/> Off		
Digital zoom	<input type="radio"/> On <input checked="" type="radio"/> Off		
Camera position display	Pan Tilt degree/Zoom ratio display		
Operation mode display	<input type="radio"/> On <input checked="" type="radio"/> Off		
Tilt Angle	0°		
Set			
Advanced setting			
Maximum optical zoom speed	High		
Maximum panning/tilting speed	Unlimited		
Pan/Tilt Operability	Profile1(Normal)		
Focus distance	Unlimited		
Double image reduction	<input checked="" type="radio"/> On <input type="radio"/> Off		
Set			

<WV-S61302-Z4> <WV-S65340-Z2> <WV-S65302-Z2>  
 <WV-S65301-Z1> <WV-S61300-ZY> <WV-S65300-ZY>  
 U653xx <WV-U61300-ZY> <WV-S65501-Z1>

Cam. Function	Position	Auto track	Auto track alarm setting
Basic settings			
Home position	Off		
Self return	Off		
Self return time			
Upside-down	<input type="radio"/> On <input checked="" type="radio"/> Off		
Maximum optical zoom ratio			
HD Extra optical zoom	<input checked="" type="radio"/> On <input type="radio"/> Off		
Digital zoom	<input type="radio"/> On <input checked="" type="radio"/> Off		
Camera position display	Pan Tilt degree/Zoom ratio display		
Operation mode display	<input type="radio"/> On <input checked="" type="radio"/> Off		
Pan/Tilt-flip	<input checked="" type="radio"/> On <input type="radio"/> Off		
Tilt Angle	0°		
Set			
Advanced setting			
Maximum optical zoom speed	High		
Maximum panning/tilting speed	Unlimited		
Pan/Tilt Operability	Profile1(Normal)		
Focus distance	Unlimited		
Set			

<WV-S61301-Z2> <WV-S61301-Z1>  
 <WV-U61301-Z2> <WV-U61301-Z1> <WV-S61501-Z1>

Cam. Function	Position	Auto track	Auto track alarm setting
Basic settings			
Home position	Off		
Self return	Off		
Self return time			
Upside-down	<input checked="" type="radio"/> On(desktop) <input type="radio"/> Off(ceiling)		
Maximum optical zoom ratio			
HD Extra optical zoom	<input checked="" type="radio"/> On <input type="radio"/> Off		
Digital zoom	<input type="radio"/> On <input checked="" type="radio"/> Off		
Camera position display	Pan Tilt degree/Zoom ratio display		
Operation mode display	<input type="radio"/> On <input checked="" type="radio"/> Off		
Pan/Tilt-flip	<input checked="" type="radio"/> On <input type="radio"/> Off		
Tilt Angle	0°		
Set			
Advanced setting			
Maximum optical zoom speed	High		
Maximum panning/tilting speed	Unlimited		
Pan/Tilt Operability	Profile1(Normal)		
Focus distance	Unlimited		
Set			

### [Home position]

When a preset position is set as the home position, “H” will be displayed next to the preset position number. A preset position (→3.7.2.1 Configure the settings relating to the preset positions (“Preset position” setup menu)) can be set as the home position.

- **Default:** Off

### Note

- To move the camera to the home position when the power of the camera is turned on, select “Home position” for “Self return”.

#### [Self return]

When the time set for “Self return time” has passed after manual operations of the camera, the camera will automatically be in the selected mode.

- **Off:** Self return is not performed.
- **Home position:** When the set time has passed, the camera will move to the home position automatically.
- **Auto pan:** When the set time has passed, the camera will start the auto pan function.
- **Preset sequence 1:** When the set time has passed, the camera will start the sequence 1 operation.
- **Preset sequence 2:** When the set time has passed, the camera will start the sequence 2 operation.
- **Preset sequence 3:** When the set time has passed, the camera will start the sequence 3 operation.
- **Patrol:** When the set time has passed, the camera will start the patrol.
- **Default:** Off

#### Note

- This function is also useful to automatically set the camera in a specific mode when the power of the camera is turned on.
- The self return function works even when the setup menu is displayed.
- “Patrol” can be set only when the patrol function is enabled. (→“3.7.2.4 Configure the settings relating to patrol (“Patrol” setup menu)”)
- Only “Patrol 1” can be set for “Patrol”. “Patrol 2”, “Patrol 3” and “Patrol 4” are unavailable.
- “Preset sequence” can be set only when the preset sequence function is enabled. (→“3.7.2.2 Configure the settings relating to the preset sequence (“Preset sequence” setup menu)”)

#### [Self return time]

Select a waiting time (amount of time until the camera starts the selected operation after the end of the manual operations) from the following.

10s/ 20s/ 30s/ 1min/ 2min/ 3min/ 5min/ 10min/ 20min/ 30min/ 60min

- **Default:** 1min

#### [Upside-down] **S653xx** **U653xx** <WV-S61302-Z4> <WV-S61300-ZY> <WV-U61300-ZY> <WV-S65501-Z1>

Select “On” or “Off” to determine whether or not to turn the image upside-down.

- **On:** The image is turned upside-down.
- **Off:** The image is not turned upside-down.
- **Default:** Off

#### [Upside-down] <WV-S61301-Z2> <WV-S61301-Z1> <WV-U61301-Z2> <WV-U61301-Z1> <WV-S61501-Z1>

Select “On (desktop)” or “Off (ceiling)” in accordance with the installation method of the camera.

**Default:** Off (ceiling)

#### [HD Extra optical zoom]

Select the HD extra optical zoom setting from the following:

- **On **Z4**:** Images can be zoomed in on with the optical zoom (1x - 40x) and the HD extra optical zoom (higher zoom factors, up to 60x).
- **On **Z2**:** Images can be zoomed in on with the optical zoom (1x - 21x) and the HD extra optical zoom (higher zoom factors, up to 31x).
- **On **Z1**:** Images can be zoomed in on with the optical zoom (1x - 10x) and the HD extra optical zoom (higher zoom factors, up to 15x).
- **On **ZY**:** Images can be zoomed in on with the optical zoom (1x - 3.1x) and the HD extra optical zoom (higher zoom factors, up to 4.6x).
- **Off:** Does not use the HD extra optical zoom. The range is within the optical zoom.

- **Default:** On

### About HD extra optical zoom

Among the valid pixels of the MOS image sensor, the central part of approx. 0.92 megapixels (equivalent to the image capture size of 1280x720) is extracted for shooting. That enables shooting with a higher zooming effect when the image capture size of 1280x720 or lower is used.

### [Digital zoom]

Select the digital zoom setting from the following.

- **On (Z4):** Images can be zoomed in on with the optical zoom (1x - 40x), the HD extra optical zoom (up to 60x), and the digital zoom (higher zoom factors, up to 640x).
- **On (Z2):** Images can be zoomed in on with the optical zoom (1x - 21x), the HD extra optical zoom (up to 31x), and the digital zoom (higher zoom factors, up to 336x).
- **On (Z1):** Images can be zoomed in on with the optical zoom (1x - 10x), the HD extra optical zoom (up to 15x), and the digital zoom (higher zoom factors, up to 160x).
- **On (ZY):** Images can be zoomed in on with the optical zoom (1x - 3.1x), the HD extra optical zoom (up to 4.6x), and the digital zoom (higher zoom factors, up to 49x).
- **Off:** Does not use the digital zoom.
- **Default:** Off

### Note

- When “On” is selected for the digital zoom, zooming will stop once right before the zoom factor is shifting to the digital zoom.
- With the digital zoom factor, the setting of the preset positions will become unavailable.
- When “Off” is selected for “HD Extra optical zoom”, “On” cannot be set for “Digital zoom”.

### [Camera position display]

When operating the camera manually, you can select what information to display in the image from the following.

- **Off:** Information is not displayed in the image.
- **Pan-Tilt degree/Zoom ratio display:** The Pan degree/Tilt degree/Zoom ratio display is displayed.
- **Direction display:** Direction display is displayed.
- **Default:** Pan-Tilt degree/Zoom ratio display

### Note

- When “Pan-Tilt degree/Zoom ratio display” is selected, the Pan-Tilt degree/Zoom ratio display is displayed in the position specified in “OSD” on the [Basic] tab. (→“3.7.2.6 Configure the settings relating to the pan/tilt angle (“Pan/tilt range setting” setup menu)”)
- When “Direction display” is selected, the direction is displayed in the position specified in “OSD” on the [Basic] tab. (→“3.7.2.5 Configure the settings relating to direction/angle setting (“Direction/Angle” setup menu)”)
- When “Direction display” is selected, configure the direction of north in “North point setting” of “Direction/Angle setting”. (→“3.7.2.5 Configure the settings relating to direction/angle setting (“Direction/Angle” setup menu)”)

### [Operation mode display]

When the camera is operating automatically, the operation mode is displayed.

- **On:** Displays the operation mode.
- **Off:** Does not display the operation mode.
- **Default:** Off

### 3 Detailed settings

Operation mode	Display
The camera is initializing.	INITIAL
The camera is auto panning.	AUTO PAN
The camera is auto tracking. <b>S613xx</b> <b>S653xx</b>	AUTO TRACKING
The camera is patrolling.	PATROL
The camera is moving through the preset sequences.	PRESET SEQ

#### [Pan/tilt-flip] **Non-Endless**

Select the pan/tilt-flip setting from the following:

- **On:** In the manual operation, when the camera is fully panned or tilted (reaches right below), the camera automatically pans at high speed to the reverse direction and continues operation without stopping at the pan- or tilt-endpoint.
- **Off:** Pan/tilt-flip does not work.
- **Default:** On

#### **Note**

- At TELE side, a partially invisible section may be generated when using the Pan/tilt-flip function.
- Click a desired point in the main area on the “Live” page that is to be the center of the angle of view. The camera will move to adjust the position in order to set the clicked point as the center. At this time, the camera continues to operate without stopping at the pan- or tilt-endpoint.
- When the flip operation is in progress, images being captured during the flip operation will be displayed.

#### [Tilt Angle]

Select the maximum degree for tilting from the following. (Level = 0°)

**ZY**

10°/ 5°/ 3°/ 0°

<WV-S65340-Z4> <WV-S65340-Z2> <WV-S65302-Z2> <WV-S65301-Z1>

<WV-U65302-Z2><WV-U65301-Z1> <WV-S65501-Z1> <WV-S61501-Z1>

10°/ 5°/ 3°/ 0°/ -3°/ -5°/ -10°/ -15°

<WV-S61302-Z4>

10°/ 5°/ 3°/ 0°/ -3°/ -5°/ -10°/ -15°/ -20°/ -25°

<WV-S61301-Z2> <WV-S61301-Z1> <WV-U61301-Z2><WV-U61301-Z1>

10°/ 5°/ 3°/ 0°/ -3°/ -5°/ -10°/ -15°/ -20°/ -25°/ -30°

**Default:** 0°

#### **Note**

- If the angle is upper than -20°, a part of the screen may become dark.

#### [Maximum optical zoom ratio]

Determine the maximum zoom ratio of the optical zoom by selecting from the following:

**ZY**

Unlimited/ x1/ x2/ x3

**Z1**

Unlimited/ x1/ x2/ x3/ x4/ x5/ x6/ x7/ x8/ x9

**Z2**

Unlimited/ x1/ x2/ x3/ x4/ x5/ x6/ x7/ x8/ x9/ x10/ x11/ x12/ x13/ x14/ x15/ x16/ x17/ x18/ x19/ x20

**Z4**

Unlimited/ x1/ x2/ x3/ x4/ x5/ x6/ x7/ x8/ x9/ x10/ x11/ x12/ x13/ x14/ x15/ x16/ x17/ x18/ x19/ x20/ x21/ x22/  
x23/ x24/ x25/ x26/ x27/ x28/ x29/ x30/ x31/ x32/ x33/ x34/ x35/ x36/ x37/ x38/ x39

**Default:** Unlimited

### [Maximum optical zoom speed]

Determine the maximum speed of the optical zoom by selecting from the following:

High/ Mid/ Low

**Default:** High

### [Maximum panning/tilting speed]

Determine the maximum speed of the pan/tilt operation by selecting from the following:

**Z1** **Z2** **Z4**

1°/s/ 2°/s/ 5°/s/ 10°/s/ 25°/s/ 50°/s/ 90°/s/ 135°/s/ 150°/s/ 300°/s/ Unlimited

**ZY**

1°/s/ 2°/s/ 5°/s/ 10°/s/ 25°/s/ 50°/s/ 90°/s/ 135°/s/ Unlimited

**Default:** Unlimited

### [Focus Distance]

When shooting a subject through glass or when an object other than the subject is close to the camera when shooting, it may be difficult to focus on the subject. In this case, the minimum focus distance can be limited.

**Z4**

Unlimited/ 3m/ 5m/ 10m

**Z2** **Z1**

Unlimited/ 1.5m/ 3m/ 5m/ 10m

**ZY**

Unlimited/ 0.3m/ 1.5m/ 3m/ 5m/ 10m

### [Double image reduction] <WV-S65340-Z4>

When shooting subjects horizontally, the light coming into the lens can be limited in order to make images clearer.

- **On:** Limits the light coming into the lens.
- **Off:** Does not limit the light coming into the lens.
- **Default:** On

### 3.7.2 Configure the settings relating to the positions [Position]

Click the [Position] tab on the “PTZ” page. (→For menu display and how to operate, refer to “3.2.1 How to display the setup menu”, “3.2.2 How to operate the setup menu”)

When the [Setup>>] button of each setting item is clicked, the detailed settings menu will be displayed in a newly opened window. The detailed settings can be configured while monitoring images displayed on the [Position] tab.

The settings relating to image adjust, preset positions, preset sequence setting, auto panning, patrol, auto-tracking, direction/angle, privacy zone, and VIQS can be configured in this section.

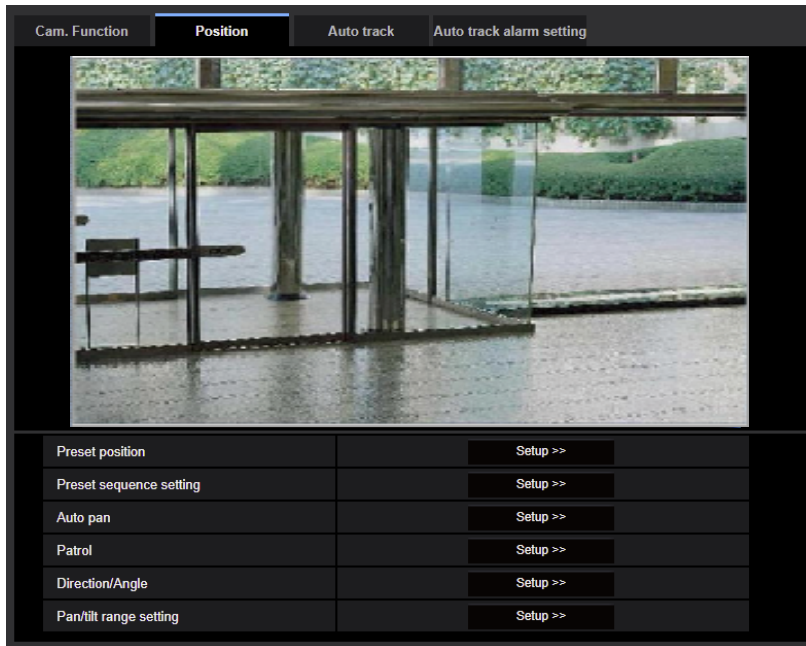

#### [Preset position]

Click the [Setup>>] button to display the setup menu that can configure the preset position. The setup menu will be displayed in a newly opened window. (→“3.7.2.1 Configure the settings relating to the preset positions (“Preset position” setup menu)”)

#### [Preset sequence setting]

Click the [Setup>>] button to display the setup menu that can configure the preset sequence. The setup menu will be displayed in a newly opened window. (→“3.7.2.2 Configure the settings relating to the preset sequence (“Preset sequence” setup menu)”)

#### [Auto pan]

Click the [Setup>>] button to display the setup menu that can configure the settings relating to the auto-panning function. The setup menu will be displayed in a newly opened window. (→“3.7.2.3 Configure the settings relating to the auto pan function (“Auto pan” setup menu)”)

#### [Patrol]

Click the [Setup>>] button to display the setup menu that can configure the settings relating to the patrol function. The setup menu will be displayed in a newly opened window. (→“3.7.2.4 Configure the settings relating to patrol (“Patrol” setup menu)”)

#### **[Direction/Angle]**

Click the [Setup>>] button to display the setup menu that can configure the settings relating to the direction/angle setting function. The setup menu will be displayed in a newly opened window. (→“3.7.2.5 Configure the settings relating to direction/angle setting (“Direction/Angle” setup menu)”)

#### **[Pan/tilt range setting]**

Click the [Setup>>] button to display the setup menu that can configure the settings relating to the pan/tilt range setting. The setup menu will be displayed in a newly opened window. (→“3.7.2.6 Configure the settings relating to the pan/tilt angle (“Pan/tilt range setting” setup menu)”)

### 3.7.2.1 Configure the settings relating to the preset positions (“Preset position” setup menu)

Click the [Setup>>] button of “Preset position” on the [Position] tab of the “PTZ” page.

It is possible to register, edit and delete the preset positions on this page.

When the focus, brightness, zoom factor are adjusted, the adjustment will be applied immediately to the currently displayed image on the [Position] tab.



#### **IMPORTANT**

- During the preset position setting, do not change other settings. The image may not be properly displayed.
- With the digital zoom factor, the setting of the preset positions will become unavailable.
- Preset position can be set to a maximum of 256 positions.



**Note**

- Depending on the environment (such as when the temperature is below 5° C (41 °F), for example), the moving speed of the camera to the preset position may become slower.

**Position No****[Preset ID]**

Select “On” or “Off” to determine whether to enable or disable the preset ID display. This function can be applied to each preset position.

- **On:** Displays the preset ID.
- **Off:** Does not display the preset ID.
- **Default:** Off

**IMPORTANT**

- When “Preset ID (0-9,A-Z)” or “Preset ID” is configured, it is necessary to click the [Set] button to apply them.

**Note**

- When “On” is selected, the entered preset ID will be displayed at the position selected for “Camera title position” on the [Basic] tab of the “Basic” page. (→[Camera title position])

**[Preset ID (0-9,A-Z)]**

Enter the preset ID to be displayed on images. This function can be applied to each preset position.

- **Available number of characters:** 0 - 40 characters
- **Available characters:** 0-9, A-Z, a-z and the following marks.  
! " # \$ % & ' ( ) \* + , - . / : ; = ?
- **Default:** None (blank)

**Note**

- The entered preset ID will be displayed next to the preset position number on the pull-down menu. When “On” is selected for “Preset ID”, the preset ID will be displayed on images.

**[Auto focus]**

Select “Auto focus” or “Off” to determine whether to enable or disable the auto focus function after the camera has moved to a preset position. This function can be applied to each preset position.

- **Auto focus:** The auto focus function will be activated after moving to a preset position.
- **Off:** Does not activate the auto focus function after moving to a preset position.
- **Default:** Off

**Note**

- When the preset position is set to shoot the following objects, it is recommended to select “Off”, and adjust the focus before registering the preset positions.
  - An object whose contrast is low
  - An object whose depth never changes
  - An object with high luminance such as a spotlight

**[Dwell time]**

Select a dwell time (duration the camera stops for at each preset position) for the preset sequence operation.  
5s/ 10s/ 15s/ 20s/ 25s/ 30s

- **Default:** 10s

#### Note

- When the preset sequence operates, preset positions that are set to “Off” will not be moved to and the sequence will move to the next position.
- Depending on the set dwell time, moving to the next preset position may start during auto focus operation.
- Using the preset sequence function for a long period of time wears the driving parts, and the replacement interval of those parts may be shortened. Refer to the Important Information for the consumable parts.

#### [Super Dynamic(SD)]

Select “On” or “Off” to determine whether or not to activate the super dynamic function.

This is not available when “Image capture mode” is set to “16:9 mode(60fps mode)” or “16:9 mode(50fps mode)”.

Refer to the description “Super Dynamic function” (→Super Dynamic function) about the super dynamic function.

- **On:** The Super Dynamic function will work.
- **Off:** The Super Dynamic function will not work.
- **Default:** Off

#### Note

- When the following are observed depending on the light condition, select “Off” for “Super Dynamic(SD)”.
  - When flickering appears or the color changes on the screen
  - When noise appears in the brighter area on the screen
- When [Light control mode] is set to “Fix shutter”, [Super Dynamic] cannot be set to “On”.
- When “On” is selected for “Stabilizer”, “Off” will automatically be set for “Super Dynamic(SD)”.

#### [Level]

Adjust the super dynamic (SD) level.

If you move the slider in the “+” direction, a subject with high contrast can be captured without over exposure or under exposure.

If you move the slider in the “-” direction, the parts with medium brightness can be captured with rich gradation.

Click the [Reset] button to reset to the default setting.

- **Default:**  
29 <WV-S65300 series> <WV-S61300 series> <WV-U65300 series> <WV-U61300 series>  
27 <WV-S65501-Z1> <WV-S61501-Z1>

#### Note

- The level can be set to up to 29 for preset positions. When “30” or higher is set for [Level] on the “Image adjust” setup menu, the image quality setting for each preset position will be disabled.  
<WV-S65501-Z1> <WV-S61501-Z1>

#### [BLC/ HLC]

Select from the following. When “On” is selected for “Super Dynamic(SD)” or when “On” is selected for “Intelligent Auto”, this setting is not available.

- **Back light compensation (BLC):** Activates the back light compensation (BLC) function.
- **High light compensation(HLC):** Activates the high light compensation (HLC) function. The high light compensation function limits the over exposure of subjects caused bright light (such as light from headlights of cars) at night.
- **Off:** Deactivates the back light compensation function and high light compensation function.
- **Default:** Off

**[BLC level]**

Adjust the BLC level.

If you move the slider in the “+” direction, the effect of back light compensation will increase.

If you move the slider in the “-” direction, the effect of back light compensation will decrease.

Click the [Reset] button to reset to the default setting.

- **Default:** 16

**[HLC level]**

Adjust the high light compensation level.

If you move the slider in the “+” direction, the effect of high light compensation (HLC) will increase.

If you move the slider in the “-” direction, the effect of high light compensation (HLC) will decrease.

Click the [Reset] button to reset to the default setting.

- **Default:** 16

**[Mask area]**

When mask area is set, the selected area is masked and you can adjust brightness.

When “On” is selected for “Super Dynamic(SD)”, this setting is not available.

Refer to “3.6.4.2 Set mask areas” for information about how to configure the mask area.

**[Zoom] buttons, [Focus] buttons, Control pad/buttons, [Brightness] buttons**

Refer to “1.1.2 About the “Live” page” for descriptions of how to operate these buttons/pad.

**[Set] button**

Registers the preset positions.

**[Delete] button**

Deletes the preset position specified by the position number.

**[Close] button**

Click this button to close the “Preset position” setup menu.

**Register the preset positions**

1. Select a preset position number.
  - The selected preset position number will be displayed in the “Position No” area.
  - When the selected number has already been registered, the camera will move to the selected preset position.
2. Move the camera to the desired direction.
3. To display the preset ID on the “Live” page, select “On” for “Preset ID” and enter the desired position title to be displayed.
4. The settings for “Auto focus” and “Dwell time” can be configured for each position independently.
5. Click the [Set] button.
6. The settings for each item such as “Super Dynamic” can be configured for each position independently. The settings for “Super Dynamic”, “BLC/ HLC” and “Mask area” are updated immediately.

**Note**

- When registering the preset position, the camera direction may move slightly.
- When a setting other than “Scene file is not applied” is selected for “Scene file” of “Image adjust”, “Super”, “BLC/ HLC”, and “Mask area” cannot be used.

### 3.7.2.2 Configure the settings relating to the preset sequence (“Preset sequence” setup menu)

Click the [Setup>>] button of “Preset sequence setting” on the [Position] tab of the “PTZ” page.  
It is possible to perform registration, editing and deletion of the preset sequence setting on this page.  
Up to 3 preset sequences can be set.

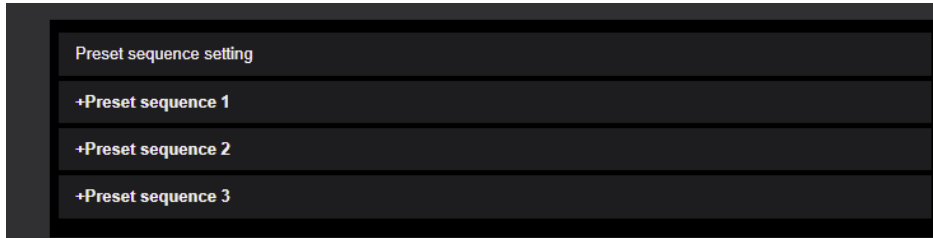

## Preset sequence setting

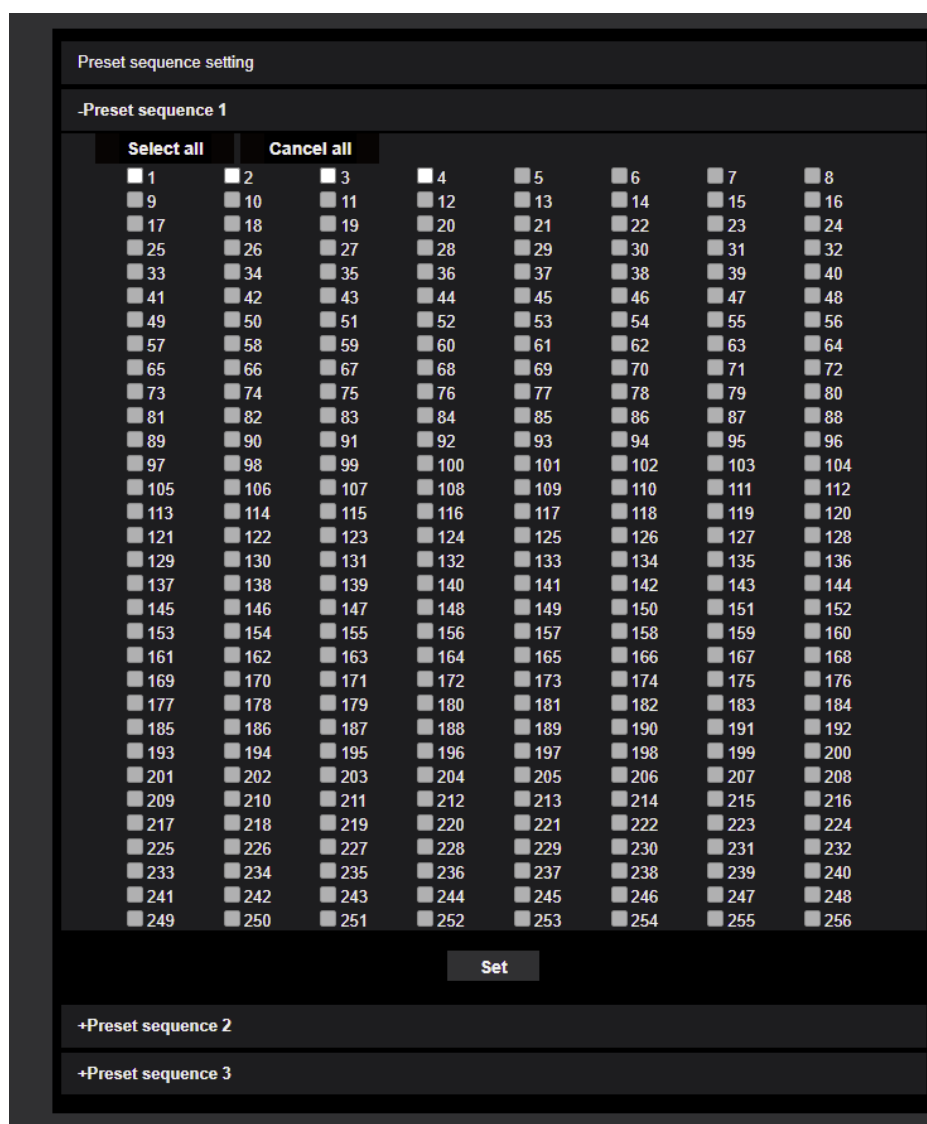

### Preset sequence 1, Preset sequence 2, Preset sequence 3

Preset sequence can be set. 3 preset sequences can be set.

- **[Select all] button:** Selects all preset positions.
- **[Cancel all] button:** Cancels all selections.
- **1 - 256:** Enables/disables the corresponding preset position.
- **[Set] button:** Saves the setting of the created preset sequence.
- **Default:** All are disabled

#### Note

- The camera will move to the registered preset positions orderly starting from the lowest preset position number during the preset sequence operation.
- After reaching the last preset position, the camera will return to the lowest preset number position and move to the preset positions orderly again.

### 3.7.2.3 Configure the settings relating to the auto pan function (“Auto pan” setup menu)

Click the [Setup>>] button of “Auto pan” on the [Position] tab of the “PTZ” page. (→“3.7.2 Configure the settings relating to the positions [Position]”)

The settings relating to the auto pan function can be configured with the setup menu.

**Note**

- Using the auto pan function for a long period of time wears the driving parts, and the replacement interval of those parts may be shortened. Refer to the Important Information for the consumable parts.

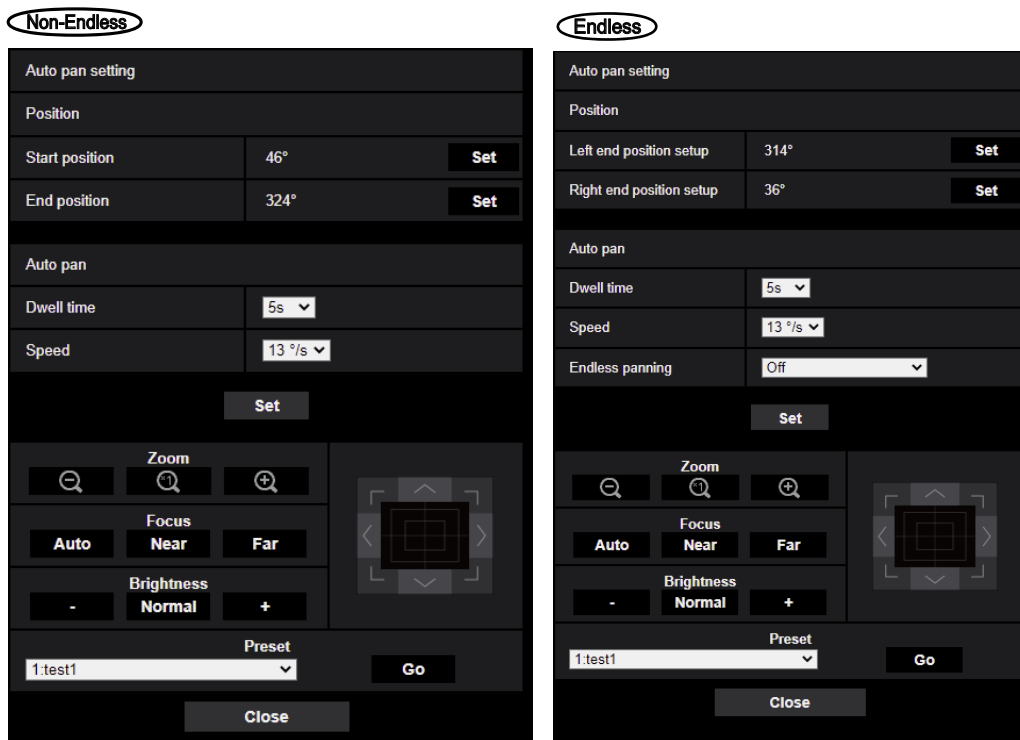

## Position

**[Left end position setup]** Endless

Move the camera to the desired point as the left end point of the auto panning using the [Zoom] button, [Focus] button, or control pad/buttons. Then, click the [Set] button. Also, the zoom and focus settings are set simultaneously.

**Note**

- Panning, tilting and zooming operations can also be carried out on the [Position] tab.

**[Right end position setup]** Endless

Move the camera to the desired point as the right end point of the auto panning using the control pad/buttons. Then, click the [Set] button.

**[Start position]** Non-Endless

Move the camera to the desired point to be set as the left end position point of the auto panning using the control pad/buttons. Then, click the [Set] button to register the position as the right end position.

Also, the zoom and focus settings are set simultaneously.

#### **Note**

- Panning, tilting and zooming operations can also be carried out on the [Position] tab.

#### **[End position]** **Non-Endless**

Move the camera to the desired point to be set as the right end position point of the auto panning using the control pad/buttons, and then click the [Set] button to register the position as the right end position.

## Auto pan

#### **[Dwell time]**

Select a dwell time at the start point and the end point from the following.

0s/ 1s/ 2s/ 3s/ 4s/ 5s/ 10s/ 15s/ 20s/ 25s/ 30s

- **Default:** 5s

#### **[Speed]**

Select a speed for the auto panning from the following.

1°/s, 2°/s, 3°/s, 4°/s, 5°/s, 7°/s, 10°/s, 13°/s, 18°/s, 24°/s

- **Default:** 13°/s

### **IMPORTANT**

- When “Auto pan” is set, it is necessary to click the [Set] button to apply them.

#### **Note**

- Even when the zoom factor for the digital zoom is set, the camera will start panning with the following zoom factor or lower:

4x **ZY**

15x **Z1**

34x **Z2**

60x **Z4**

#### **[Endless panning]** **Endless**

The operations for panning can be set to the following

**Off:** Pan between the left and right end position points.

**On(Clockwise):** Pans clockwise.

**On(Counterclockwise):** Pans counterclockwise.

**Default:** Off

### **[Zoom] buttons, [Focus] buttons, [Brightness] buttons, Control pad/buttons and [Go] button**

Refer to “1.1.2 About the “Live” page” for descriptions of how to operate these buttons/pad.

#### **[Close] button**

Click this button to close the “Auto pan” setup menu.

### 3.7.2.4 Configure the settings relating to patrol (“Patrol” setup menu)

Click the [Setup>>] button of “Patrol” on the [Position] tab of the “PTZ” page (→3.7.2 Configure the settings relating to the positions [Position]).

Here, the information related to patrol is set.

The patrol function can be configured to learn pan, tilt, zoom, and focus settings and operations, and then use these learned settings and operations to operate the camera.

**Note**

- Using the patrol function for a long period of time wears the driving parts, and the replacement interval of those parts may be shortened. Refer to the Important Information in the supplied CD-ROM for the consumable parts.

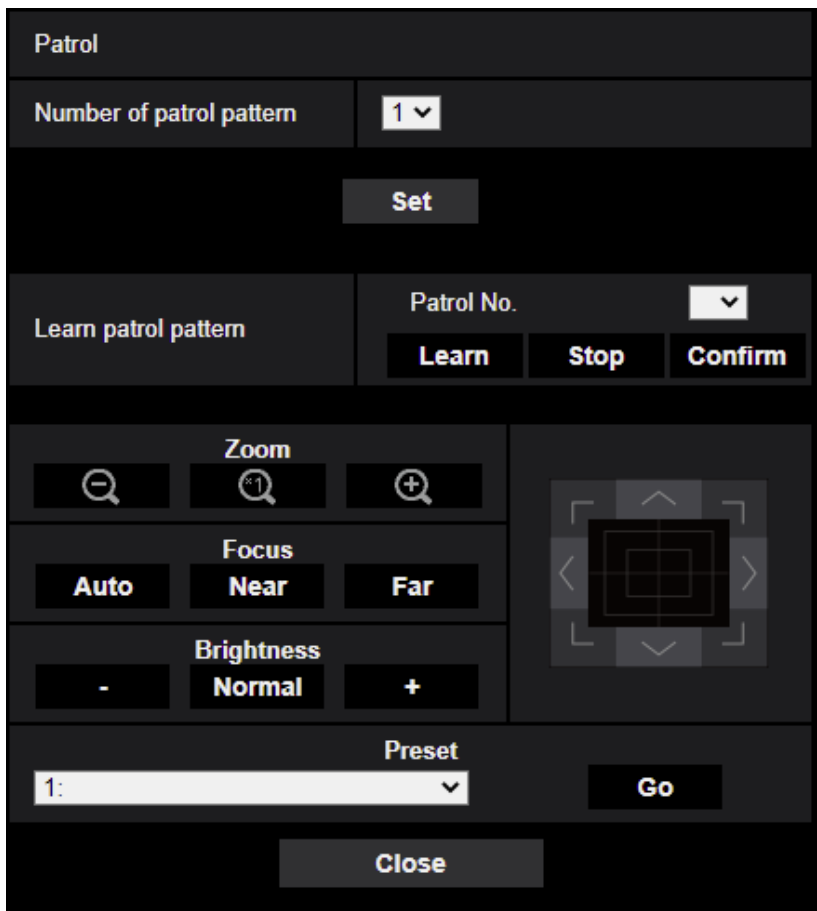

### Patrol setting

**[Number of patrol pattern]**

Select the patrol pattern number. The length of patrol patterns that can be learned differs depending on the pattern number.

- **1:** 2 minutes of operations can be learned for Patrol 1.
- **2:** 1 minute of operations can be learned for both Patrol 1 and Patrol 2.
- **4:** 30 seconds of operations can be learned each for Patrol 1, Patrol 2, Patrol 3, and Patrol 4.
- **Default:** 1



**Note**

- When the number of control patterns is changed, the learned patrol operations are deleted.

**[Learn patrol pattern]**

Click [▼] of "Patrol No." and select a patrol number (1-4) from the pull-down menu. An asterisk (\*) next to the patrol number indicates that the patrol operation has already been learned for the patrol number.

With the patrol number selected, click the [Learn] button to start learning the camera operations. During learning, "LEARNING (\*\*S)" is displayed on the screen. "\*\*\*\*S" is the length of possible learning time remaining. Click the [Stop] button to stop learning and replaying camera operations. When the remaining time is zero seconds (0S), operations are automatically stopped.

With the patrol number selected, click the [Confirm] button to replay the learned camera operations.

**Note**

- The following are the camera operations that can be learned.
  - Start position operations  
pan/tilt/zoom/focus position
  - Camera operations  
pan/tilt/zoom/focus position/moving the preset position
- The auto focus function cannot be used when performing patrol operations. As a characteristic of zoom lenses, when images are zoomed up from the "Wide" side, they may become blurred. When learning zoom operations, starting from the "Tele" side will reduce blurring.

**[Zoom] buttons, [Focus] buttons, [Brightness] buttons, Control pad/buttons and [Go] button**

Refer to "1.1.2 About the "Live" page" for descriptions of how to operate these buttons/pad.

**[Close] button**

Click this button to close the "Patrol" setup menu.

### 3.7.2.5 Configure the settings relating to direction/angle setting (“Direction/Angle” setup menu)

Click the [Setup>>] button of “Direction/Angle” on the [Position] tab of the “PTZ” page. (→“3.7.2 Configure the settings relating to the positions [Position]”)

Here, the information related to the direction/angle setting is set. The pan/tilt position moves to the position set as north when displaying this page.

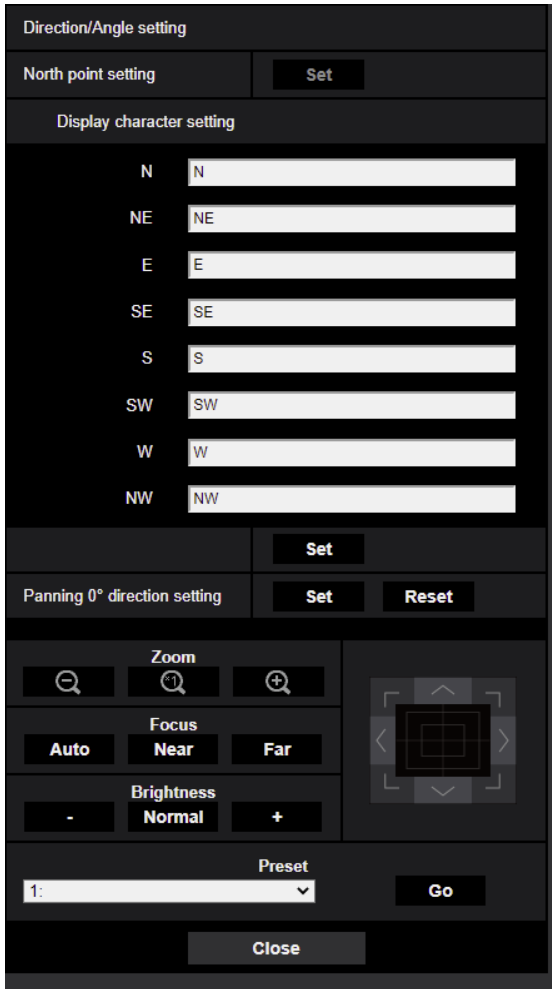

#### Direction/Angle setting

If “Direction display” is selected for “Camera position display” on the [Cam. Function] tab on the “PTZ” page, one of the eight directions will be indicated instead of the preset position title.

##### [North point setting]

A point where the North point (N) is to be displayed will be set by pressing the [Set] button in a state where the panning position of the camera is aligned.

##### [Display character setting]

Names can be given to each direction individually.

**N:** Set a name for the “North” direction.

**Default:** N

**NE:** Set a name for the “North-East” direction.

**Default:** NE

**E:** Set a name for the “East” direction.

**Default:** E

**SE:** Set a name for the “South-East” direction.

**Default:** SE

**S:** Set a name for the “South” direction.

**Default:** S

**SW:** Set a name for the “South-West” direction.

**Default:** SW

**W:** Set a name for the “West” direction.

**Default:** W

**NW:** Set a name for the “North-West” direction.

**Default:** NW

### **[Panning 0° direction setting]** Endless

Configure the Panning 0° direction setting. When the [Set] button is clicked after adjusting the angle of view with the control pad/buttons, the current direction of the pan becomes 0°. Click the [Reset] button to reset to the default setting.

#### **Note**

- The tilt 0° angle is not configured.
- Even if the Panning 0° direction is changed, there is no change to the preset positions already configured. The range of the auto pan setting and the actions of the patrol setting already configured are also not changed.

### **[Zoom] buttons, [Focus] buttons, [Brightness] buttons, Control pad/buttons and [Go] button**

Refer to “1.1.2 About the “Live” page” for descriptions of how to operate these buttons/pad.

#### **[Close] button**

Click this button to close the “Direction/Angle” setup menu.

### 3.7.2.6 Configure the settings relating to the pan/tilt angle (“Pan/tilt range setting” setup menu)

Click the [Setup>>] button of “Pan/tilt range setting” on the [Position] tab of the “PTZ” page. (→“3.7.2 Configure the settings relating to the positions [Position]”)  
Specify the pan/tilt angle on this page.

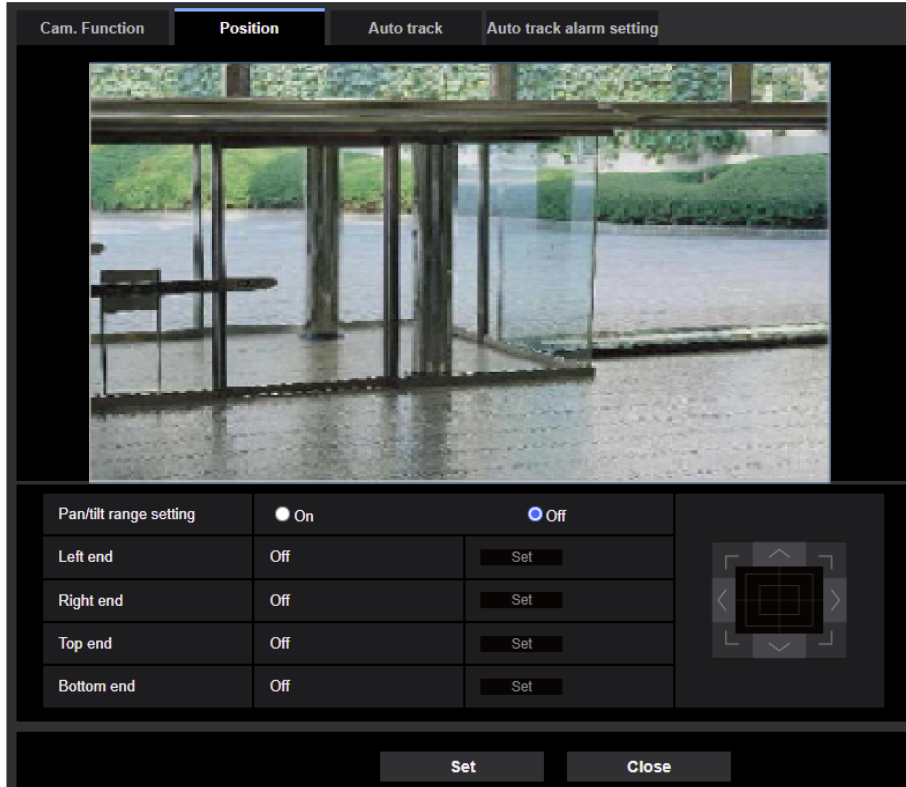

#### Pan/tilt range setting

Select “On” or “Off” to determine whether to enable the range where the pan/tilt operation is limited. Select “On” and set [Left end]/ [Right end]/ [Top end]/ [Bottom end] by adjusting the angle of view using the control pad/buttons.

**Default:** Off

#### [Left end]/ [Right end]/ [Top end]/ [Bottom end]

When the [Set] button is clicked after adjusting the angle of view using the control pad/buttons, angle of the set position will be displayed.

- **Default:** Off

#### Note

- Set the angles so that the angle of [Left end] is smaller than the angle of [Right end] and also the angle of [Bottom end] is larger than the angle of [Top end].  
When “On” is selected for [Upside-down], set the angles so that the angle of [Bottom end] is smaller than the angle of [Top end].  
When “On (desktop)” is selected for [Upside-down], set the angles so that the angle of [Bottom end] is smaller than the angle of [Top end].

- Be sure to perform the setting of [Pan/tilt range setting] on a screen that is not enlarged (zoomed). When the settings are performed on an enlarged (zoomed) screen, changing the zoom ratio to “x1” will display a larger area than the area displayed at the time of the setting (enlarged).
- When the settings are incorrectly made, it may result in displaying of images from the camera that are not supposed to be displayed. Be sure to check images by executing the pan/tilt operation after performing the settings.
- Before setting the preset position, perform the setting of [Pan/tilt range setting]. When the preset position is set outside of the range of [Pan/tilt range setting], the preset position will stop at the end point within the range of [Pan/tilt range setting].
- When the [Pan/tilt range setting] setup menu is displayed, the zoom ratio will automatically be set to “x1”.
  - While the setting of [Pan/tilt range setting] is performed, “PT LIMIT SETTING” will be displayed within the image.
  - When no operation is performed for 5 minutes, the [Set] button of [Pan/tilt range setting] will be disabled. To continue the operation, display the Pan/Tilt range setting menu again and perform the setting.

### 3.7.3 Configure the settings relating to auto track (“Auto track” setup menu) S613xx S653xx

Click the [Auto track] tab on the “PTZ” page.

It is possible to perform registration, editing and deletion of the auto track setting on this page.

#### Note

- The auto-track setup is not available under the following conditions:
  - When either of “16:9 mode(60fps mode)”, “16:9 mode(50fps mode)”, “4:3 mode(15fps mode)” or “4:3 mode(12.5fps mode)” is selected for [Image capture mode]
  - When [Maximum shutter] of [Image adjust] - [Light control mode] is the following:  
Max. 2/30s/ Max. 4/30s/ Max. 6/30s/ Max. 10/30s/ Max. 16/30s
- Using the auto track function for a long period of time wears the driving parts, and the replacement interval of those parts may be shortened. Refer to “Basic Information” for the consumable parts.

The auto track function automatically tracks and captures images of the subject when it is detected in an auto pan, preset sequence/preset position, patrol or area, that has been set in advance.

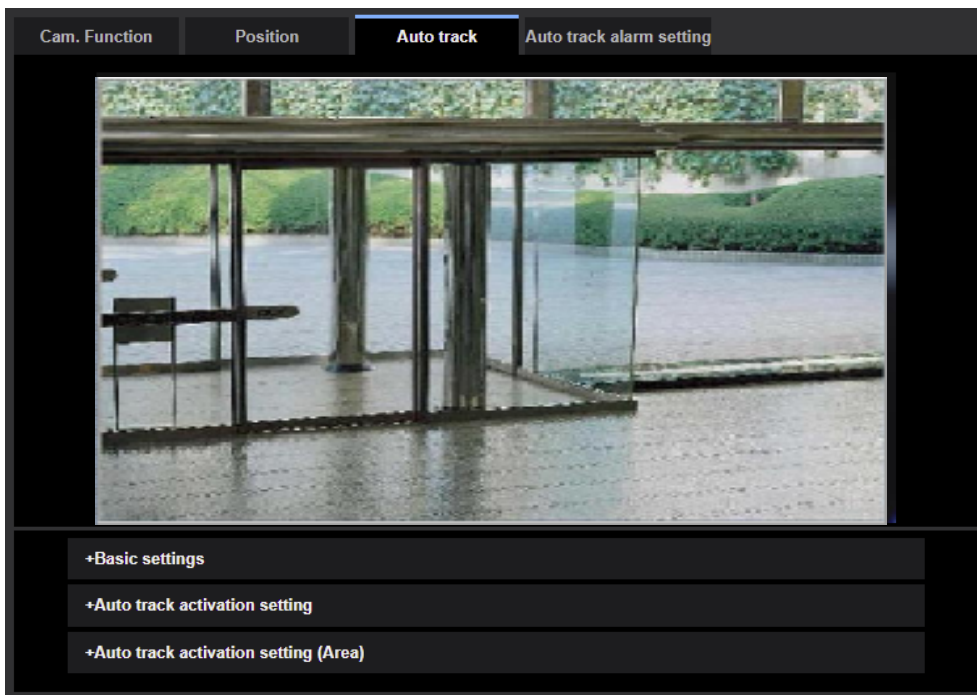

## Basic settings

### [Detection object]

Select types of objects to be detected. A selection of multiple types of objects is available.

- **Human:** Auto track will be performed when a human is detected.
- **Vehicle:** Auto track will be performed when a vehicle is detected.
- **Bicycle:** Auto track will be performed when a bicycle is detected.

### [Object size]

Select an object size from the following.

**Small(1/4 of the image):** The tracking target is enlarged to about 1/4 the size (lengthwise) of the monitor screen.

**Middle(1/2 of the image):** The tracking target is enlarged to about 1/2 the size (lengthwise) of the monitor screen.

**Large(3/4 of the image):** The tracking target is enlarged to about 3/4 the size (lengthwise) of the monitor screen.

**No size adjustment:** Does not perform the zoom control during the auto track.

- **Default:** Small(1/4 of the image)

#### **Note**

- The sizes described here are only a guide. Depending on the environment conditions and the tracking conditions the displayed size may be different from the expected size.
- Increasing the display size of the tracking target reduces the tracking capabilities.

#### **[Sensitivity]**

Select the tracking sensitivity from the following.

High/Middle/Low

- **Default:** Middle

#### **Note**

- Reducing the sensitivity can help reduce false detections such as when a tree is swaying, but it will also reduce the tracking capabilities. On the other hand, increasing the sensitivity increases the tracking capabilities but also increases false detections. Match the settings according to where the camera is used.

#### **[Longest tracking time]**

Select the time that tracking will be forced to stop after it started auto tracking from the following.

Off(Unlimited)/ 10s/ 20s/ 30s/ 40s/ 50s/ 1min/ 2min/ 3min/ 5min/ 10min

- **Default:** Off(Unlimited)

#### **Note**

- The camera will stop at a position at a point of time when the set longest tracking time has elapsed. To return to auto mode, set the self return, and after tracking is finished, the self return time is counted and the camera returns to auto mode.

#### **[Auto track data in video stream]**

Select "On" or "Off" to determine whether to transmit image data to which SCD information is added and superimposed.

**Off:** Auto track data is not added to images.

**On:** Auto track data is added to images, but an outline of the tracking target is not displayed on the "Live" page.

**On with track video display:** Auto track data is added to images and an outline of the tracking target is displayed on the "Live" page.

- **Default:** Off

## **Auto track activation setting**

#### **[Auto pan]**

Select "On" or "Off" to determine whether to start the auto track during the auto pan.

- **On:** Starts the auto track during the auto pan.
- **Off:** Does not start the auto track during the auto pan.
- **Default:** Off

#### **[Preset sequence/Preset position]**

Select "On" or "Off" to determine whether to start the auto track during image transmission by the preset sequence operation or the preset position operation.

### 3 Detailed settings

---

- **On:** Starts the auto track during image transmission by the preset sequence operation or the preset position operation.
- **Off:** Does not start the auto track during image transmission by the preset sequence operation or the preset position operation.
- **Default:** Off

#### [Preset position selection]

- **[Select all] button:** Selects all preset positions.
- **[Cancel all] button:** Cancels all selections.
- **1 - 256:** Enables/disables the corresponding preset position.
- **[Set] button:** Saves the setting of the created preset sequence.
- **Default:** All are disabled

#### [Patrol]

Select “On” or “Off” to determine whether to start the auto track during the patrol.

- **On:** Starts the auto track during the patrol.
- **Off:** Does not start the auto track during the patrol.
- **Default:** Off

## Auto track activation setting (Area)

#### [Area select]

It is possible to start the auto track when a [Detection object] appears in the set area. Up to 8 areas can be set.

- **[Set] button:** Sets an area where the auto track starts in the designated area No..
- **[Delete] button:** Deletes the area where the auto track starts in the designated area No..
- **[Cancel] button:** Cancels the auto track area setting that is currently being edited.

#### [Zoom] buttons, [Focus] buttons, Control pad/buttons, [Brightness] buttons, and [Go] button

Refer to “1.1.2 About the “Live” page” for descriptions of how to operate these buttons/pad.

#### [Close] button

Click this button to close the “Auto track” setup menu.

#### **IMPORTANT**

- In the following situations, targets may not be able to be tracked, or false detections may occur.
  - when there is little contrast between the subject and the background
  - when dirt, drip, or splash is on the front panel
  - when there are large changes to the lighting intensity
  - when there are many moving objects other than the subject
  - when there is a change on the optical axis (in a vertical direction) of the camera
  - when the subject moves directly underneath the camera
  - when there is harsh flickering
  - when there are reflections from light entering the front panel due to reflections from a window or road, or from a backlight
  - when the target is hidden behind a utility pole or other objects
  - when the subject passes by other moving objects
  - when the target moves too fast or too slow
  - when the camera is shaking
  - when the weather is significantly worse
  - when “On” is selected for “Stabilizer”



- In no event shall we be liable to any consequential inconvenience, or loss or damage, arising out of the settings or results of the auto tracking system.
- We recommend that you use this setting under the following setting conditions to improve the detection accuracy.
  - set the size of the tracking target to over 1/5 of the monitoring screen (lengthwise)

## Procedure to setup auto track cooperation

If 2 or more cameras that support the auto track function are used, tracking of targets can be coordinated between cameras. (Auto track cooperation setting)

For example, the procedure for getting Camera 2 (IP address: 192.168.0.12) to take over auto tracking from Camera 1 (192.168.0.11) when the tracking target enters into alarm area No.1 during auto tracking as shown below, is explained here.

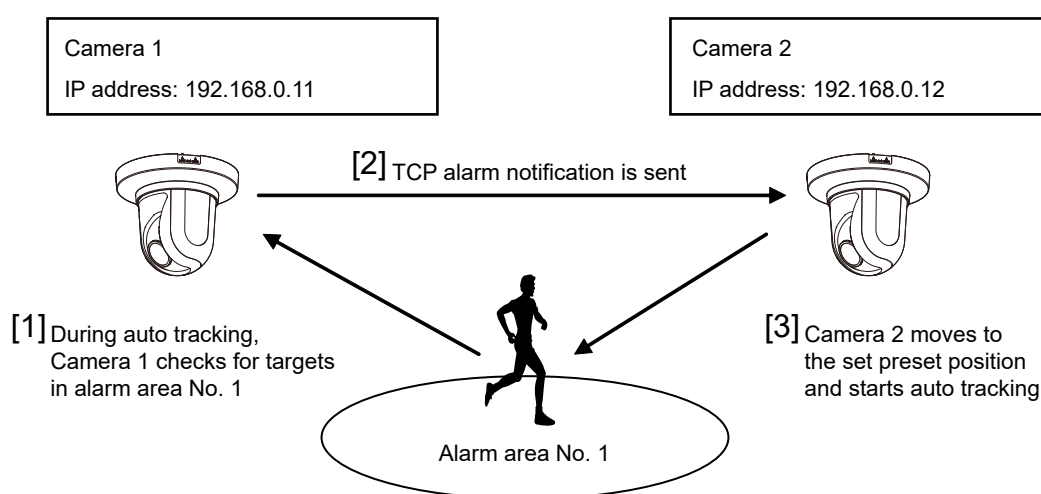

1. Set an alarm area to Camera 1 in the area where you want to perform auto track cooperation.
  - ① Display the "Auto track setting" page.
  - ② With "Auto track alarm" select "On(In preset alarm area)" and click the [Set] button.
  - ③ Select "1" from the "Area No." pull-down menu of "Area select" in "Alarm area".
  - ④ While monitoring images, perform the pan/tilt/zoom, and then set the alarm area.
  - ⑤ Click the [Set] button.
2. On Camera 2, configure the preset position for received notification commands. (Configure the preset position so that alarm area No. 1 enters the screen as configured in step 1.)
  - ① Display the "Preset position" setting page. (→"3.7.2.1 Configure the settings relating to the preset positions ("Preset position" setup menu)")
  - ② Select a preset number that you want set from the "Preset" pull-down menu.
  - ③ While monitoring images, perform the pan/tilt/zoom, and then set the preset position.
  - ④ Click the [Set] button.
3. Set Camera 1 (IP address: 192.168.0.11) to notify commands.
  - ① Display the "Notification" screen from the "Alarm" page. (→"3.9.10 Configuration of the settings relating to alarm notification [Notification]")
  - ② From "TCP alarm notification", set "TCP alarm notification" to "On" and click the [Set] button.
  - ③ From "Destination of notification", check the "Alarm" checkbox of "Address 1" (any notification destination address can be selected), and enter 192.168.0.12 in "Destination IP address".
  - ④ Set "Auto track cooperation" to "On", and select "1" for the alarm area number.
  - ⑤ Click the [Set] button.

### 3 Detailed settings

---

4. Configure the settings of Camera 2 (IP address: 192.168.0.12), which receives notification commands from the other cameras.
  - ① Display the “Alarm” screen from the “Alarm” page. (→“3.9.1 Configure the settings relating to the alarm action [Alarm]”)
  - ② From “Alarm”, set “Command alarm” to “On” and click the [Set] button.
  - ③ Set the “Command alarm” of “Camera action on alarm” to “Preset per sender”, and click “Preset per sender >>”.
  - ④ On the “Preset per sender” setup menu (→“3.9.4.1 Configure the settings relating to Preset per sender (“Preset per sender” setup menu)”), check the “Auto track cooperation” checkbox of “Sender’s address 1” (any destination address can be used) and enter 192.168.0.11 (Camera 1) for the sender’s address. Then select the preset position set at step 2, click the [Set] button, and then close the page.
  - ⑤ Click the [Set] button.
5. Auto track cooperation can be used by starting the auto tracking for Camera 1.

### 3.7.4 Configure the settings relating to auto track alarm (“Auto track alarm” setup menu) S613xx S653xx

Click the [Auto track alarm setting] tab of the “PTZ” page.  
Here, the information related to the auto track alarm setting is set.

#### Note

- The auto-track setup is not available under the following conditions:
  - When either of “16:9 mode(60fps mode)”, “16:9 mode(50fps mode)” or “4:3 mode(15fps mode)” or “4:3 mode(12.5fps mode)” is selected for [Image capture mode]
  - When “Maximum shutter” of “Image adjust” - “Light control mode” is the following:  
Max.2/30s/ Max.4/30s/ Max.6/30s/ Max.10/30s/ Max.16/30s
- Using the auto track function for a long period of time wears the driving parts, and the replacement interval of those parts may be shortened. Refer to the Important Information for the consumable parts.

The auto track function can be used to detect movement in a predetermined alarm area and automatically track and capture images of the subject detected in that area.

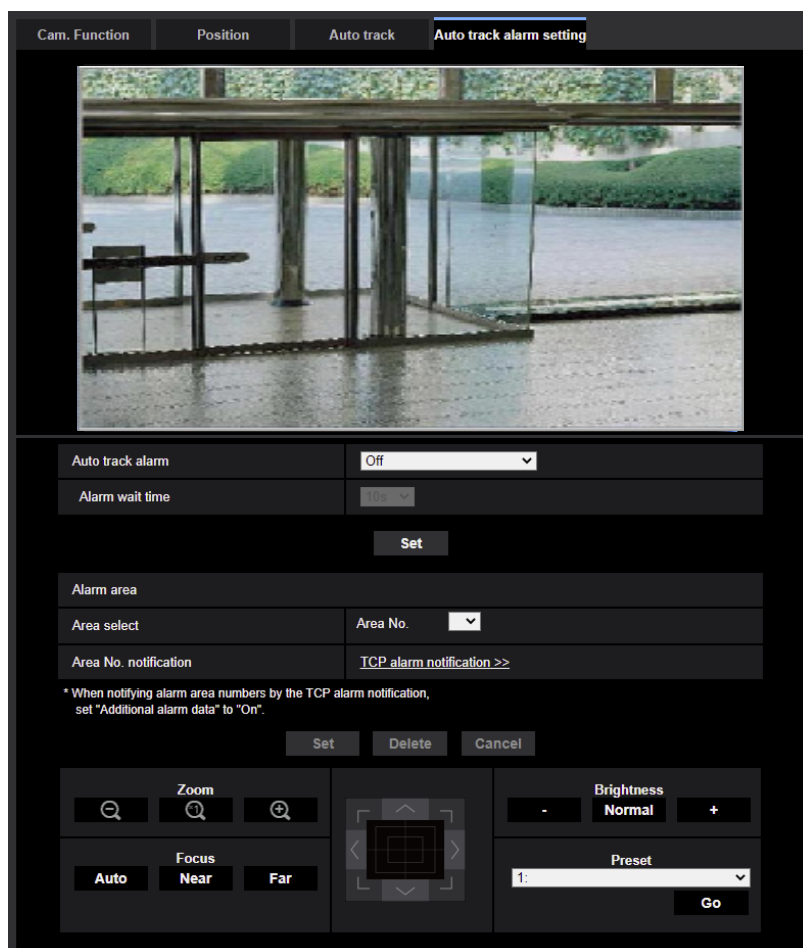

#### [Auto track alarm]

Select an alarm to be used when auto tracking from the following.

**Off:** An alarm is not outputted.

**On(Immediate):** Alarms are continuously outputted during auto tracking. (Outputs are made at 5 second intervals.)

### 3 Detailed settings

---

**On(After alarm wait time):** Alarms are outputted only once when the auto tracking is continuously performed for a set period.

**On(In preset alarm area):** While tacking, if the tracking target enters the set alarm area, an alarm is outputted once. Refer to “Alarm area” for information about alarm areas.

**Default:** Off

#### **[Alarm wait time]**

Select a setting time from the following when “Auto track alarm” is set to “On(After alarm wait time)”.

1s/10s/30s/1min/3min/5min

**Default:** 10s

## Alarm area

#### **[Area select]**

Click [▼] of “Area No.” and select an area number (1-8) from the pull-down menu. An asterisk (\*) next to the area number indicates that the area has already been learned. When “On(In preset alarm area)” (when there is an alarm area intrusion) is selected with “Auto track alarm”, the alarm area will become active.

#### **[Area No. notification]**

When “TCP alarm notification >> ” is clicked, the [Notification] tab of the “Alarm” page will be displayed.

(→3.9.10 Configuration of the settings relating to alarm notification [Notification])

#### **Note**

- The alarm area cannot be configured separately for each preset position. The configured alarm area is active for all preset areas.

## 3.8 Configure the multi-screen settings

### [Multi-screen]

The cameras from which images are to be displayed on a multi-screen can be registered on the “Multi-screen” page. (→“3.2.1 How to display the setup menu”, “3.2.2 How to operate the setup menu”)

#### [IP address]

Enter the IP address or the host name of the camera to be used for the multi-screen. 4 cameras can be registered as a group and up to 4 groups (16 cameras) can be registered.

When the HTTP port number for the camera of which images are to be displayed had been changed, enter as follows:

#### Example of entry:

- **Example when entering an IPv4 address:** http://192.168.0.10:8080
- **Example when entering an IPv6 address:** http://[2001:db8:0:0:0:0:1]:8080

To access the cameras using the HTTPS protocol, enter as follows:

**Example of entry:** https://192.168.0.10/

- **Available number of characters:** 1 - 128 characters
- **Default:** (Cam. 1) selfcamera, (Cam. 2 - 16) not registered

#### **IMPORTANT**

- When accessing the camera using the HTTPS protocol, it is necessary to install the pre-installed certificate or the CA certificate of the camera to display images on the monitor. For how to install, refer to video clips <Control No.: P0002> and <Control No.: P0003> on the support video page on our support website.
- This camera is specified when “selfcamera” is displayed for the IP address or host name.

#### **Note**

- For further information about “Network Camera Recorder with Viewer Software Lite”, which is suited to viewing images from several cameras, refer to our technical information website <Control No.: C0301>.
- When using the host name, it is necessary to configure the DNS settings of the PC to be used for the multi-screen display. Refer to the network administrator for information on the DNS setting of PCs.

#### [Camera title]

Enter the title of the camera. The entered camera title will be displayed on a multi-screen.

- **Available number of characters:** 0 - 20 characters
- **Unavailable characters:** " &
- **Default:**
  - (Cam. 1) The model No. is displayed.
  - (Cam. 2 - 16) None (blank)

#### **Note**

- When selecting a 16 split-screen, some characters of the camera title to be displayed may not be displayed.
- Even when “16:9” is selected for the aspect ratio, the multi-screen is displayed in 4:3.

## Initial display

#### [Layout]

Select the layout for the initial display from the following:

### 3 Detailed settings

---

4 Screens(1-4)/ 4 Screens(5-8)/ 4 Screens(9-12)/ 4 Screens(13-16)/ 9 Screens(1-9)/ 9 Screens(10-16)/ 16 Screens

- **Default:** 4 Screens(1-4)

#### [Refresh interval]

Select the refresh interval during initial display.

- **MJPEG:** Displays the camera image in the motion JPEG format (video).
- **Refresh interval : 1s/ Refresh interval : 3s/ Refresh interval : 5s/ Refresh interval : 10s/ Refresh interval : 30s/ Refresh interval : 60s:** Displays the JPEG format (still image) camera image in the selected interval.
- **Default:** MJPEG

#### [Image capture size(4 Screens)]

Select the image capture size for 4 screens in initial display.

640x360/320x180

- **Default:** 320x180

## 3.9 Configure the alarm settings [Alarm]

The settings relating to alarm actions using the external I/O terminals of the camera, alarm image, the VMD area settings, and the alarm occurrence notification can be configured on the “Alarm” page.

The “Alarm” page has the [Alarm] tab, the [VMD area] tab, the [SCD area] tab, [Audio] tab, and the [Notification] tab.

### 3.9.1 Configure the settings relating to the alarm action [Alarm]

Click the [Alarm] tab on the “Alarm” page. (→“3.2.1 How to display the setup menu”, “3.2.2 How to operate the setup menu”)

The settings relating to the alarm can be configured in this section. Refer to “3.9.4 Configure the settings relating to the camera action on alarm occurrence [Alarm]” and “3.9.2 Configure the settings relating to the output terminal [Alarm]” for further information about the settings relating to the alarm images and the alarm output terminal.

## Alarm

### [Terminal 1]

Determine how to use terminal 1.

- **Off:** Not used.
- **Alarm input(TRM1):** Receives alarms. When “Alarm input” is selected, a pull-down menu for “Close”, “Open”, “Close(Continue)”, and “Open(Continue)” is displayed.
  - **Close:** An alarm is detected when the terminal status is changed to “Close”.
  - **Open:** An alarm is detected when the terminal status is changed to “Open”.
  - **Close(Continue):** An alarm is detected when the terminal status is changed to “Close”. When “Close” is selected for the terminal status, alarm detection will be performed regularly at a fixed interval set by “Alarm deactivation time”.
  - **Open(Continue):** An alarm is detected when the terminal status is changed to “Open”. When “Open” is selected for the terminal status, alarm detection will be performed regularly at a fixed interval set by “Alarm deactivation time”.
- **Black & white input:** Receives the black & white switchover input. (When the input is set to On, the black & white mode is activated.)
- **Auto time adjustment:** Receives the time adjustment input. When the signal is received and if the clock is within 29 minutes ± the hour, the time will be adjusted to 00 minutes 00 seconds. During SD memory card recording, the time is not changed in operations which reset the time under 5 seconds. When “Auto time adjustment” is selected, a pull-down menu for “Close” and “Open” is displayed.
  - **Close:** The time is adjusted when the terminal status is changed to “Close”.
  - **Open:** The time is adjusted when the terminal status is changed to “Open”.
- **Default:** Off

### [Terminal 2]

Determine how to use terminal 2.

- **Off:** Not used.
- **Alarm input(TRM2):** Receives alarms. When “Alarm input” is selected, a pull-down menu for “Close”, “Open”, “Close(Continue)”, and “Open(Continue)” is displayed.
  - **Close:** An alarm is detected when the terminal status is changed to “Close”.
  - **Open:** An alarm is detected when the terminal status is changed to “Open”.
  - **Close(Continue):** An alarm is detected when the terminal status is changed to “Close”. When “Close” is selected for the terminal status, alarm detection will be performed regularly at a fixed interval set by “Alarm deactivation time”.

### 3 Detailed settings

---

- **Open(Continue):** An alarm is detected when the terminal status is changed to “Open”. When “Open” is selected for the terminal status, alarm detection will be performed regularly at a fixed interval set by “Alarm deactivation time”.
- **Alarm output:** Alarm output will be carried out according to the settings for “Output terminal”. (→“3.9.2 Configure the settings relating to the output terminal [Alarm]”)
- **Default:** Off

#### [Terminal 3]

Determine how to use terminal 3.

- **Off:** Not used.
- **Alarm input(TRM3):** Receives alarms. When “Alarm input” is selected, a pull-down menu for “Close”, “Open”, “Close(Continue)”, and “Open(Continue)” is displayed.
  - **Close:** An alarm is detected when the terminal status is changed to “Close”.
  - **Open:** An alarm is detected when the terminal status is changed to “Open”.
  - **Close(Continue):** An alarm is detected when the terminal status is changed to “Close”. When “Close” is selected for the terminal status, alarm detection will be performed regularly at a fixed interval set by “Alarm deactivation time”.
  - **Open(Continue):** An alarm is detected when the terminal status is changed to “Open”. When “Open” is selected for the terminal status, alarm detection will be performed regularly at a fixed interval set by “Alarm deactivation time”.
- **AUX output:** AUX output will be supplied. The [AUX] buttons will be displayed on the “Live” page.
- **Default:** Off

#### **IMPORTANT**

- In order for the EXT I/O terminals to detect alarm inputs when the terminal status is changed from Open to Close (On) or from Close to Open (Off), about 100 ms or more is needed. Because alarms cannot be detected for about 5 seconds after a detection is made, alarm inputs received within about 5 seconds after an alarm is detected are not detected.

#### **Note**

- AUX is a camera terminal that allows users to operate (Open/Close) arbitrarily from the “Live” page. For example, an operator can remotely control lights in a place where the camera is installed by connecting the terminal to the light controller.
- Refer to the Installation Guide for further information about input/output rating of each terminal.

#### [VMD alarm]

When clicking “VMD >>”, the [VMD area] tab of the “Alarm” page will be displayed. (→“3.9.6 Set the VMD areas [VMD area]”)

#### [SCD alarm]

When clicking “SCD”, the [SCD area] tab of the “Alarm” page will be displayed. (→“3.9.7 Configure the SCD settings [SCD area]”)

#### [Auto track alarm] **S613xx** **S653xx**

When “Auto track setting” is clicked, the [Auto track alarm setting] tab of the “PTZ” page will be displayed. (→“3.7.4 Configure the settings relating to auto track alarm (“Auto track alarm” setup menu) **S613xx** **S653xx**”)

#### [Audio detection alarm]

When clicking “Audio detection”, the [Audio detection] tab of the “Alarm” page will be displayed. (→“3.9.9 Configure the settings relating to the audio detection [Audio detection]”)



**[Command alarm]**

Select "On" or "Off" to determine whether or not to receive the command alarm.

The command alarm is the function that provides notification of a TCP alarm notification from the other cameras. When "On" is selected, alarm actions will be performed between multiple cameras.

- **Default:** Off

**[Reception port]**

Select a port number to be used to receive the command alarm.

- **Available range:** 1-65535
- **Default:** 8181

The following port numbers are unavailable since they are already in use.

20, 21, 22, 23, 25, 42, 53, 67, 68, 69, 80, 110, 123, 161, 162, 443, 554, 995, 1883, 8883, 10669, 10670, 59000-61000

**[Alarm deactivation time]**

Configure the duration that detections won't be made after an alarm is detected. For example, by using this function you can prevent E-mail from being sent too often when E-mail notifications are configured to be sent to a mobile terminal or tablet device when an alarm is detected.

5-600s

- **Default:** 5s

**Note**

- The duration that alarm detections are not made can be managed for each type of alarm. For example, even during the time when alarm detection for command alarm is not being performed, VMD alarms and SCD alarms will be detected.

**[Alarm test]**

Click the [Execute] button to execute the alarm test function.

**Note**

- When the test alarm function is executed, the camera will detect a command alarm. This can be used to check the SD recording or notification to external devices triggered by alarm detection. Check the related settings using the system logs of this camera and the external device set as the notification destination.
- The test alarm function cannot be executed multiple times during the alarm deactivation time.

## 3.9.2 Configure the settings relating to the output terminal [Alarm]

Click the [Alarm] tab on the “Alarm” page. (→“3.2.1 How to display the setup menu”, “3.2.2 How to operate the setup menu”)

The settings relating to the output terminal can be configured in this section.

### Output terminal

In order to be able to configure “Output terminal”, “Alarm output” must be selected for [Terminal 2] of the [Alarm] setting.

#### [Terminal output upon alarm detection]

Select “On” or “Off” to determine whether or not to output the alarm signals to the output terminal when an alarm is detected.

- **Default:** Off

#### [SD memory card error]

Select “On” or “Off” to determine whether or not to output signals from the output terminal when an error is detected for the SD memory card.

SD memory card error condition: SD memory card error (write error, read error, etc), Total use time over 6 years, and number of overwrites over 2000 times

- **On:** When an error status is detected, the signals from an output terminal is outputted and the [Alarm occurrence indication] on the “Live” page blinks.
- **Off:** Deactivates the warning status detection.
- **Default:** Off

### **IMPORTANT**

- In order to be able to correctly use this function, format the SD memory card with the camera before using it.

#### **Note**

- The total service time of 6 years is the total power-on time from the SD card being inserted. 2000 cycles are the upper limit overwrite counts of the industrial SD memory card (MLC type). These are typical values and not a guarantee of the SD card lifetime.
- The output terminal and the SD memory card errors use the same output terminal.
- A signal is outputted to the output terminal when either an alarm or SD memory card error occurs.
- When an SD memory card error is detected, the [Alarm occurrence notification] popover will be displayed on the “Live” page blinks. The [Alarm occurrence notification] popover can be closed by clicking the [×] button on the [Alarm occurrence notification] popover.
- Output signals from the output terminal for [SD memory card error] differ depending on the settings of [Terminal state upon alarm detection].
  - When “Latch” is selected: Even after you click the [Alarm occurrence indication] and it disappears, output signals from the output terminal will continue as long as the cause of the [SD memory card error] is not resolved.
  - When “Pulse” is selected: Even after you click the [Alarm occurrence indication] and it disappears, output signals from the output terminal will continue as long as the cause of the [SD memory card error] is not resolved. However, if the time period specified for [Pulse output width] is exceeded, output signals from the output terminal will be stopped.

#### [Terminal state upon alarm detection]

Select “Latch” or “Pulse” for the output terminal at an alarm occurrence.

- **Latch:** When an alarm is detected, the output terminal will be in the state selected for “Terminal action upon alarm detection” until the [×] button on the [Alarm occurrence notification] popover is clicked.
- **Pulse:** When an alarm is detected, the output terminal will be in the state to the “Terminal action upon alarm detection” setting for the period set for “Pulse output width”. When the [×] button on the [Alarm occurrence notification] popover is clicked, the output terminal will return to the normal state.
- **Default:** Latch

#### [Terminal action upon alarm detection]

Select “Open” or “Close” to determine whether to open or close the output terminal when outputting the alarm signals.

- **Open:** The output terminal will open when outputting the alarm signals. (Normally close)
- **Close:** The output terminal will close when outputting the alarm signals. (Normally open)
- **Default:** Close

#### Note

- When “Open” is selected, the alarm signal will be output for about 20 seconds when the power of the unit is turned on.

#### [Pulse output width]

When “Pulse” is selected for “Terminal state upon alarm detection”, select an output terminal duration from the following.

- **Available range:** 1-120s
- **Default:** 1s

### 3.9.3 Change the AUX name [Alarm]

Click the [Alarm] tab on the “Alarm” page. (→“3.2.1 How to display the setup menu”, “3.2.2 How to operate the setup menu”)

The names of “AUX”, “Open” and “Close” on the “Live” page can be changed.

#### AUX title

##### [AUX (Up to 10 characters)]

Enter the name for “AUX” on the “Live” page.

- **Unavailable characters:** " &
- **Default:** AUX

##### [Open (Up to 5 characters)]

Enter the name for “Open” of “AUX” on the “Live” page.

- **Unavailable characters:** " &
- **Default:** Open

##### [Close (Up to 5 characters)]

Enter the name for “Close” of “AUX” on the “Live” page.

- **Unavailable characters:** " &
- **Default:** Close

##### **Note**

- AUX name can be changed when “AUX output” is selected for “Terminal 3” of “Alarm”.
- AUX is a camera terminal that allows users to operate (Open/Close) arbitrarily from the “Live” page. For example, an operator can remotely control lights in a place where the camera is installed by connecting the terminal to the light controller.

## 3.9.4 Configure the settings relating to the camera action on alarm occurrence [Alarm]

Click the [Alarm] tab on the “Alarm” page. (→“3.2.1 How to display the setup menu”, “3.2.2 How to operate the setup menu”)

The settings related to the camera action on alarm can be configured in this section.

### [Terminal alarm 1]

Select an action to be taken when a terminal alarm 1 is detected from the following.

This setting is available when “Terminal 1” is selected for “Alarm input(TRM1)” of the [Alarm] tab.

- **Off:** Does not take any action even when a terminal alarm 1 is detected.
- **1-256:** If a previously registered preset position is selected, when a terminal alarm 1 is detected, the camera will move to that position.
- **Patrol 1:** When a terminal alarm 1 is detected, the camera will start the patrol.  
\* If “Patrol 1” is not registered, it is not displayed on the screen.
- **Default:** Off

### [Terminal alarm 2]

Select an action to be taken when a terminal alarm 2 is detected from the following.

This setting is available when “Terminal 2” is selected for “Alarm input(TRM2)” of the [Alarm] tab.

- **Off:** Does not take any action even when a terminal alarm 2 is detected.
- **1-256:** If a previously registered preset position is selected, when a terminal alarm 2 is detected, the camera will move to that position.
- **Patrol 2:** When a terminal alarm 2 is detected, the camera will start the patrol.  
\* If “Patrol 2” is not registered, it is not displayed on the screen.
- **Default:** Off

### [Terminal alarm 3]

Select an action to be taken when a terminal alarm 3 is detected from the following.

This setting is available when “Terminal 3” is selected for “Alarm input(TRM3)” of the [Alarm] tab.

- **Off:** Does not take any action even when a terminal alarm 3 is detected.
- **1-256:** If a previously registered preset position is selected, when a terminal alarm 3 is detected, the camera will move to that position.
- **Patrol 3:** When a terminal alarm 3 is detected, the camera will start the patrol.  
\* If “Patrol 3” is not registered, it is not displayed on the screen.
- **Default:** Off

### [VMD alarm]

Select an action to be taken when a VMD alarm is detected from the following.

- **Off:** Does not take any action even when a VMD alarm is detected.
- **1-256:** If a previously registered preset position is selected, when a VMD alarm is detected, the camera will move to that position.
- **Patrol 1:** When a VMD alarm is detected, the camera will start the patrol.  
\* If “Patrol 1” is not registered, it is not displayed on the screen.
- **Default:** Off

### [SCD alarm]

Select an action to be taken when an SCD alarm is detected from the following.

- **Off:** Does not take any action even when an SCD alarm is detected.
- **1-256:** If a previously registered preset position is selected, when an SCD alarm is detected, the camera will move to that position.
- **Patrol 1:** When an SCD alarm is detected, the camera will start the patrol.

\* If “Patrol 1” is not registered, it is not displayed on the screen.

- **Default:** Off

#### [Audio detection alarm]

Select an action to be taken when a sound alarm is detected from the following.

- **Off:** Does not take any action even when a sound alarm is detected.
- **1-256:** If a previously registered preset position is selected, when a sound alarm is detected, the camera will move to that position.
- **Patrol 1:** When a sound alarm is detected, the camera will start the patrol.  
\* If “Patrol 1” is not registered, it is not displayed on the screen.
- **Default:** Off

#### [Command alarm]

Select an action to be taken when a command alarm is detected from the following.

This setting is available when “On” is selected for “Command alarm”.

- **Off:** Does not take any action even when a command alarm is detected.
- **1-256:** If a previously registered preset position is selected, when a command alarm is detected, the camera will move to that position.
- **Patrol 1:** When a command alarm is detected, the camera will start the patrol.  
\* If “Patrol 1” is not registered, it is not displayed on the screen.
- **Preset per sender:** By registering the sender’s address for the command alarm and the preset position for that address, the camera will move to the preset position when an alarm is detected from the command alarm.  
Click “Preset per sender >>” to open a separate window for setting the preset positions per sender.  
(→“3.9.4.1 Configure the settings relating to Preset per sender (“Preset per sender” setup menu)”)
- **Default:** Off

#### [Alarm E-mail notification]

Click “E-mail server >>” to display the setup menu that can configure the settings relating to E-mail notification when an alarm occurs. The setup menu will be displayed in a newly opened window. (→“3.9.4.2 Configure settings relating to alarm E-mail notifications”)

#### [Alarm image FTP/SFTP transmission]

Click “FTP/SFTP setup >>” to display the setup menu that can configure the settings relating to FTP/SFTP transmission when an alarm occurs. The setup menu will be displayed in a newly opened window. (→“3.9.4.3 Configure settings relating to FTP/SFTP transmissions of alarm images”)

#### [Alarm image recording(SD memory card)]

Click “SD memory card setup >>” to display the setup menu that can configure the settings relating to recording images on an SD memory card when an alarm occurs. The setup menu will be displayed in a newly opened window. (→“3.9.4.4 Configure settings relating to recording to an SD memory card when an alarm occurs”)

#### [TCP alarm notification]

Click “TCP alarm notification >>” to display the setup menu that can configure the settings relating to transmitting TCP alarm notifications when an alarm occurs. The setup menu will be displayed in a newly opened window. (→“3.9.4.5 Configure settings relating to TCP alarm notification when an alarm occurs”)

#### [HTTP alarm notification]

Click “HTTP alarm notification setup >>” to display the setup menu that can configure the settings relating to transmitting HTTP alarm notifications when an alarm occurs. The setup menu will be displayed in a newly opened window. (→“3.9.4.6 Configure settings relating to HTTP alarm notification when an alarm occurs”)

### [SNMP transmission upon alarm detection]

Click “To SNMP setting” to display the setup menu that can configure the settings relating to SNMP transmission when an alarm occurs. The setup menu will be displayed in a newly opened window.  
(→“3.9.4.7 Configure settings relating to SNMP transmissions of alarm images”)

## 3.9.4.1 Configure the settings relating to Preset per sender (“Preset per sender” setup menu)

On the [Alarm] tab of the “Alarm” page (→3.9.1 Configure the settings relating to the alarm action [Alarm]), click “Preset per sender” for “Command alarm”.

The sender’s address for the command alarm, and the preset position for that address can be registered in this section.

Preset per sender			
Sender's address 1	<input type="text"/>	Set	Close
	<input type="radio"/> On <input checked="" type="radio"/> On	<input type="radio"/> Off <input checked="" type="radio"/> Off	Notification per Camera Alarm area No. Reception setting during live view
Sender's address 2	<input type="text"/>	Set	Close
	<input type="radio"/> On <input checked="" type="radio"/> On	<input type="radio"/> Off <input checked="" type="radio"/> Off	Notification per Camera Alarm area No. Reception setting during live view
Sender's address 3	<input type="text"/>	Set	Close
	<input type="radio"/> On <input checked="" type="radio"/> On	<input type="radio"/> Off <input checked="" type="radio"/> Off	Notification per Camera Alarm area No. Reception setting during live view
Sender's address 4	<input type="text"/>	Set	Close
	<input type="radio"/> On <input checked="" type="radio"/> On	<input type="radio"/> Off <input checked="" type="radio"/> Off	Notification per Camera Alarm area No. Reception setting during live view
Sender's address 5	<input type="text"/>	Set	Close
	<input type="radio"/> On <input checked="" type="radio"/> On	<input type="radio"/> Off <input checked="" type="radio"/> Off	Notification per Camera Alarm area No. Reception setting during live view
Sender's address 6	<input type="text"/>	Set	Close
	<input type="radio"/> On <input checked="" type="radio"/> On	<input type="radio"/> Off <input checked="" type="radio"/> Off	Notification per Camera Alarm area No. Reception setting during live view
Sender's address 7	<input type="text"/>	Set	Close
	<input type="radio"/> On <input checked="" type="radio"/> On	<input type="radio"/> Off <input checked="" type="radio"/> Off	Notification per Camera Alarm area No. Reception setting during live view

### [Sender's address 1] - [Sender's address 48]

Set the sender’s IP address for the command alarm, and the preset position for that address. Up to 48 notification addresses can be set.

### [Notification per Camera]

When the sender is a multi-sensor camera, select a sender’s camera number. In cases other than that, select “1”.

**Default:** 1

### [On/Off] (link with Alarm area No.)

Select “On” or “Off” to determine whether or not to link with Alarm area No.

**Default:** Off

### [Alarm area No.]

When setting the link with alarm area No., select the alarm area of the transmission source from No. 1 to No. 8.

**Default:** 1

### [On/Off] (Reception setting during live view)

Select “On” or “Off” to determine whether or not to link with the click operation on live view from the multi-sensor camera.

**Default:** Off

### [Close] button

Click this button to close the “Preset per sender” setup menu.

### 3.9.4.2 Configure settings relating to alarm E-mail notifications

Click “E-mail server >>” of “Camera action on alarm” on the [Alarm] tab of the “Alarm” page. (→“3.9.4 Configure the settings relating to the camera action on alarm occurrence [Alarm]”)

Refer to “3.11.2.1 Configure the settings related to sending E-mails” for information on configuration for these settings.

### 3.9.4.3 Configure settings relating to FTP/SFTP transmissions of alarm images

Click “FTP/SFTP setup >>” of “Camera action on alarm” on the [Alarm] tab of the “Alarm” page. (→“3.9.4 Configure the settings relating to the camera action on alarm occurrence [Alarm]”)

Refer to “3.11.2.2 Add FTP/SFTP image transmission function” for information on configuration for these settings.

The screenshot shows a configuration page for FTP/SFTP settings. It is divided into several sections:

- Transmission protocol:** Radio buttons for FTP and SFTP. SFTP is selected.
- Alarm setting:** Radio buttons for On and Off. Off is selected.
- Alarm image transmission:** Radio buttons for On and Off. Off is selected.
- Directory name:** A text input field.
- File name:** Checkboxes for Terminal 1, Terminal 2, Terminal 3, VMD, SCD, and Auto track. Below these are checkboxes for Command alarm and Audio detection. A note states: "For alarms by the 'Ext. software', alarm images will be transmitted only by configuring the alarm image SFTP transmission."
- FTP transmission retry:** Radio buttons for On and Off.
- Pre alarm:** Fields for Transmission interval, Maximum number of images, and Recording duration (0s).
- Post alarm:** Fields for Transmission interval, Number of images, and Recording duration (100s).
- Image capture size:** A dropdown menu showing (320x180).
- SFTP server setting:** Fields for SFTP server address (with example 192.168.0.10), Port number (22, range 1-65535), Host key hash (SHA256, with example dQVcdVZ2ySO5tz/R6YR-rptW6dnap6F743uMV0c0), User name, and Password.
- FTP server setting:** Fields for FTP server address (with example 192.168.0.10), User name, Password, Control port (range 1-65535), and FTP mode (Passive or Active).

### 3.9.4.4 Configure settings relating to recording to an SD memory card when an alarm occurs

Click “SD memory card setup >>” of “Camera action on alarm” on the [Alarm] tab of the “Alarm” page. (→“3.9.4 Configure the settings relating to the camera action on alarm occurrence [Alarm]”)

Refer to “3.5.2 Configure the settings relating to the SD memory card [SD memory card]” for information on configuration for these settings.



### 3.9.4.5 Configure settings relating to TCP alarm notification when an alarm occurs

Click “TCP alarm notification >>” of “Camera action on alarm” on the [Alarm] tab of the “Alarm” page.  
(→“3.9.4 Configure the settings relating to the camera action on alarm occurrence [Alarm]”)  
Refer to “3.9.10.1 Configure the settings relating to TCP alarm notification” for information on configuration for these settings.

### 3.9.4.6 Configure settings relating to HTTP alarm notification when an alarm occurs

Click “HTTP alarm notification setup >>” of “Camera action on alarm” on the [Alarm] tab of the “Alarm” page.  
(→“3.9.4 Configure the settings relating to the camera action on alarm occurrence [Alarm]”)  
Refer to “3.9.10.2 Configure the settings relating to HTTP alarm notification” for information on configuration for these settings.

### 3.9.4.7 Configure settings relating to SNMP transmissions of alarm images

Click “To SNMP setting” of “Camera action on alarm” on the [Alarm] tab of the “Alarm” page. (→“3.9.4 Configure the settings relating to the camera action on alarm occurrence [Alarm]”)  
Refer to “3.11.2.7 Configure the settings relating to SNMP” for information on configuration for these settings.

## 3.9.5 Configure the VMD settings [VMD area]

Click the [VMD area] tab on the “Alarm” page. (→“3.2.1 How to display the setup menu”, “3.2.2 How to operate the setup menu”)

The video motion detection areas can be set on this page.

The VMD areas can be set up to 4 areas for each preset position (maximum 256 preset positions). When motion is detected in the set area, it will be regarded as an alarm. The camera can be configured to take an alarm action even when the camera is not at the preset position.

### IMPORTANT

- The alarm occurrence indication (→“1.1.2 About the “Live” page”) will be displayed when motion is detected by the VMD function.
- The alarm occurrence indication will be displayed when receiving an alarm input of a terminal alarm or a command alarm.
- Depending on the network environment, notification may be delayed.
- After configuring the VMD area, the VMD area may move out of alignment when “Image capture mode” of the [Basic] tab is changed. Make sure to check the VMD area after changing the “Image capture mode” setting.
- The motion detection function is not the dedicated function to prevent thefts, fires, etc. We are not responsible for any accidents or damages that may occur.
- Be aware that a VMD alarm may occur due to changes in the brightness of the whole image depending on the status of the object when “On” is selected for “Intelligent auto”. In such a case, set either of the following:
  - Select “On” for “Light detection control” of VMD.
  - Move the slider of “Detection sensitivity” of the VMD area in the “-” direction.
  - Move the slider of “Face priority level(Brightness)” of “Intelligent auto” in the “-” direction.

## Preset position selection and VMD information addition

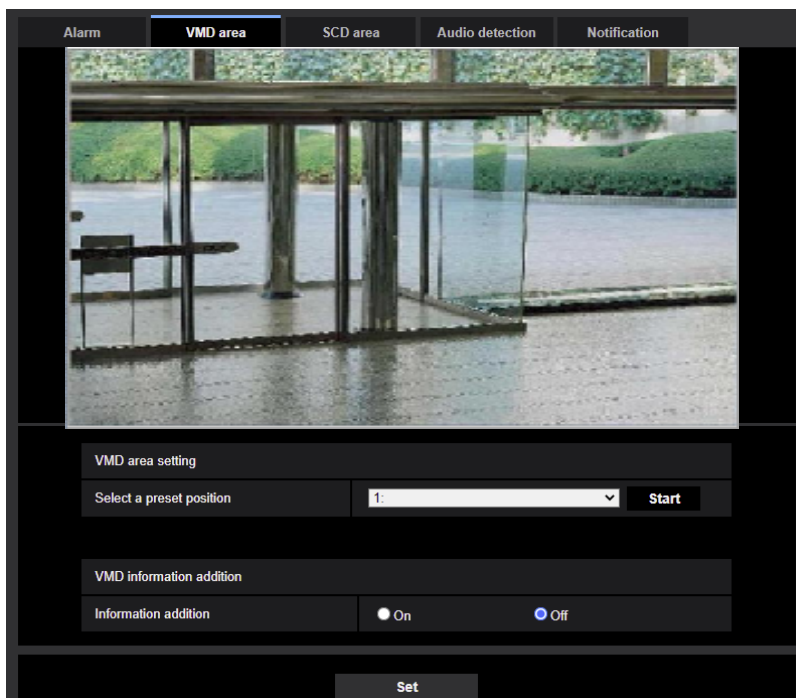

## VMD area setting

- **[Select a preset position]**  
Select a preset position number to which the VMD area is to be set, and click the [Start] button.  
When setting an area which is not at the preset position for the VMD area, select VMD activation in area “except the preset positions”.

## VMD information addition

- **[Information addition]**  
Select “On” or “Off” to determine whether or not to add VMD information to superimposed image data.  
The VMD information can be searched by some of our network disk recorders.  
Refer to the operating instructions of the connected devices for further information about the functions and settings.
  - **Default:** Off

## VMD area setting

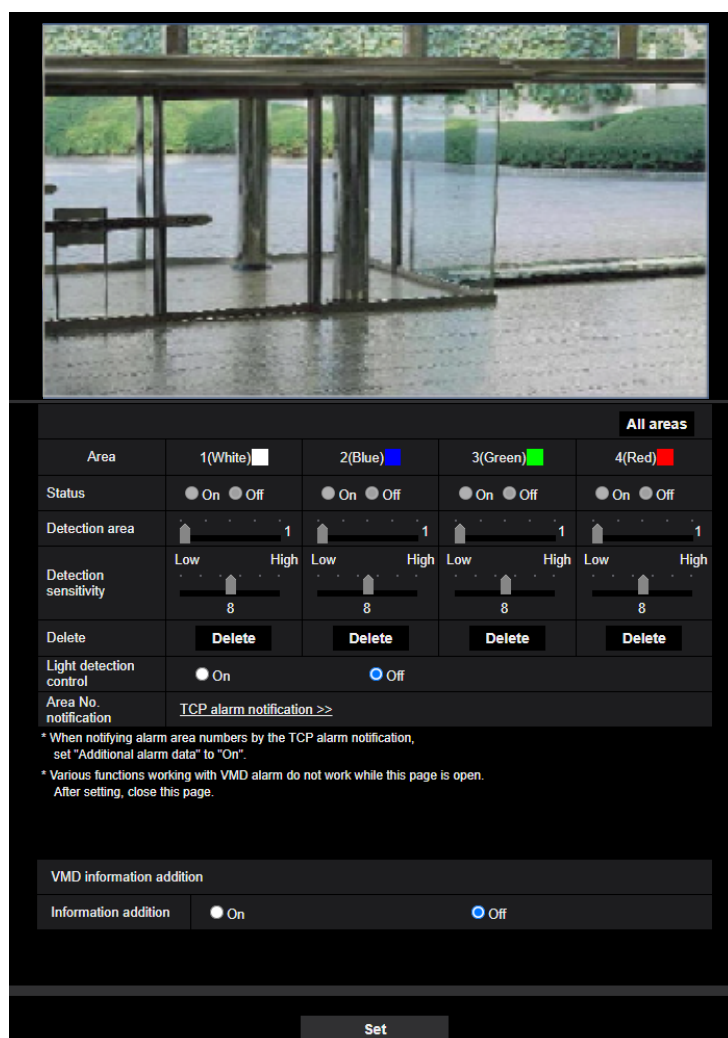

### [Area]

When selecting a VMD area in the screen, it will be numbered as area 1. (Subsequent areas will be numbered in the order of selection.)

#### **[All areas] button**

When the [All areas] button is clicked, the whole area will become the VMD area, and "1(White)" will be automatically applied to "Area".

#### **[Status]**

Select "On" or "Off" to determine whether or not to perform video motion detection.

- **On:** Performs video motion detection.
- **Off:** Does not perform video motion detection.
- **Default:** Off

#### **[Detection area]**

Adjust the size of the VMD area using the slider. The smaller the selected value is, the higher the sensitivity of VMD area becomes. The current value (1-10) will be displayed on the right of the slider.

- **Default:** 1

#### **[Detection sensitivity]**

Adjust the sensitivity of motion detection in the VMD area using the slider. The settings can be configured for each area individually. The larger the value is set, the higher the sensitivity level becomes.

The current value (1 (low) - 15 (high)) will be displayed below the slider.

- **Default:** 8

#### **[Delete] button**

Click the [Delete] button corresponding to the area to be deleted. The outline of the selected area will be deleted.

#### **[Light detection control]**

Select "On" or "Off" to determine whether or not to suspend video motion detection affected by brightness change such by a dimming level control.

- **Default:** Off

#### **IMPORTANT**

- "Light detection control" may not work when brightness change is too small.
- When "On" is selected for "Light detection control", the video motion detection may not be performed even when detecting a subject moving over the whole screen.

#### **[Area No. notification]**

When "TCP alarm notification >>" is clicked, the [Notification] tab of the "Alarm" page will be displayed. (→"3.9.10 Configuration of the settings relating to alarm notification [Notification]")

### 3.9.6 Set the VMD areas [VMD area]

Set the areas to activate the VMD function.

#### IMPORTANT

- During change of setting in the setup menu, no alarm will be detected. After setup is complete, close the setup menu.
1. Set the video motion detection area by dragging the mouse on the screen.
    - The designated area will become the VMD area “1(White)” and the outline will be displayed. When 2 - 4 VMD areas are set, each area will be numbered in order. The areas will be identified by the respective outline colors. The “Status” of the outline to be set for the area will become “On”.

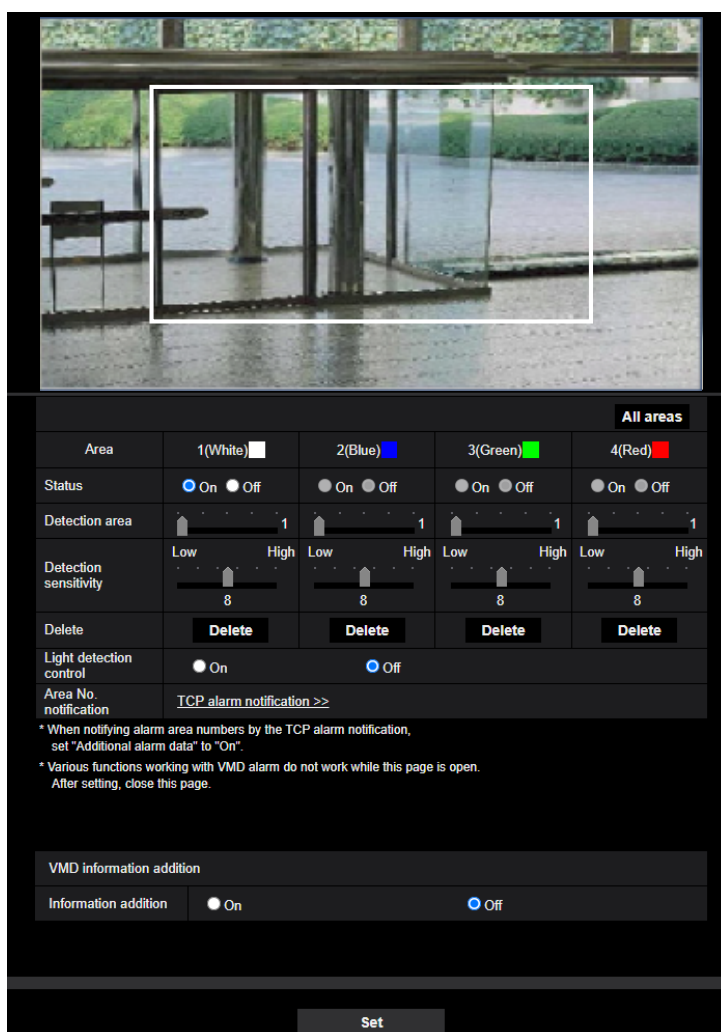

2. Adjust “Detection area” and “Detection sensitivity” using the slider. Refer to “3.9.5 Configure the VMD settings [VMD area]” for further information about the “Detection sensitivity” and “Detection area”. The currently displayed area and its detection sensitivity will be displayed in the “Detection area” section. Change areas and the settings of “Detection area” and “Detection sensitivity” as necessary.

### 3 Detailed settings

---

3. Click the [Set] button after completing the settings.

#### **IMPORTANT**

- The setting will not be applied unless the [Set] button is clicked.
4. To invalidate the VMD area, click the [Set] button after selecting “Off” for “Status” of the VMD area to be invalidated.
    - The outline of the invalidated VMD area will turn to a dotted line. When the VMD area is invalidated, no alarm will occur even when a motion can be recognized in the area.
  5. To delete the VMD area, click the [Delete] button corresponding to the area to be deleted.
    - The outline of the respective VMD area will disappear.
  6. Click the [Set] button.
    - The edited settings will be applied.

### 3.9.7 Configure the SCD settings [SCD area]

Click the [SCD area] tab on the “Alarm” page. (→For menu display and how to operate, refer to “3.2.1 How to display the setup menu”, “3.2.2 How to operate the setup menu”)

By configuring SCD (scene change detection) setting, it is possible to issue an alarm when a camera is covered with something or the camera direction is changed to shoot a different subject.

The detection area using the SCD function can be set on this section. Up to 1 area can be set. When a shooting subject is changed in the set area, it will issue an alarm.

#### **IMPORTANT**

- Since it takes time for necessary learning in the following period, the SCD will not function for a while.
  - Right after the SCD is set
  - After the power of this product is turned on
  - After a scene change is detected
- The alarm occurrence indication (→“1.1.2 About the “Live” page”) will be displayed when scene change is detected by the SCD function.
- The alarm occurrence indication will be displayed at a VMD alarm occurrence or when receiving a command alarm as well.
- After configuring the SCD area, the SCD area may move out of alignment when “Upside-down” of the [Basic] tab is changed. Make sure to check the SCD area after changing the “Image capture mode” setting.
- In the following cases, scene change may not be detected.
  - Only a part of the shooting area is covered or the covered object can be seen.
  - Subjects look alike each other before and after the camera direction has been changed.
  - In the area where the privacy zone is set.
- The SCD function is not the dedicated function to prevent thefts, fires, etc. We are not responsible for any accidents or damages that may occur.
- When “Detection time” of “SCD area” is shorter than “Dwell time” of “Day & Night(IR)”, a scene change detection (SCD) may be activated at the time when an image is switched to BW. It can be improved by setting “Dwell time” of “Day & Night(IR)” shorter than “Detection time” of “SCD area”.
- When the image color is close to monochrome, detection of SCD alarms may become difficult. When no alarms is detected, increase “Detection sensitivity” or set smaller “Detection area”.

#### **[All areas] button**

Set the entire image in the SCD area.

#### **[Status]**

Select “On” or “Off” to determine whether or not to perform SCD.

- **On:** Performs SCD.
- **Off:** Does not perform SCD.
- **Default:** Off

#### **[Detection area]**

Set the detection ratio “Small”, “Middle” or “Large”, which specifies how much of change in the area set in [SCD area] to be detected.

- **Default:** Middle

#### **[Detection sensitivity]**

Adjust the SCD sensitivity in the SCD area and select from “Very Low”, “Low”, “Middle”, or “High”.

- **Default:** Middle

#### **[Detection time]**

The SCD function issues an alarm when the scene change continues for a specified time of period.

### 3 Detailed settings

---

3s/5s/10s/30s/1min

- **Default:** 3s

#### **[Delete] button**

Click the [Delete] button to be deleted the selected area.

#### **SCD information addition**

##### **[Information addition]**

Select “On” or “Off” to determine whether or not to add SCD information to superimposed image data.

- **Default:** Off

#### **Note**

- Additional SCD information will not be used on our network disk recorders. (As of June, 2021)



### 3.9.8 Set the SCD areas [SCD area]

Set the areas to activate the SCD (scene change detection) function.

#### **IMPORTANT**

- During change of setting in the setup menu, no alarm will be detected. After setup is complete, close the setup menu.
1. Set the SCD area by dragging the mouse on the screen.
    - The designated area will become the SCD area and the outline of white color will be displayed. The “Status” will become “On”.

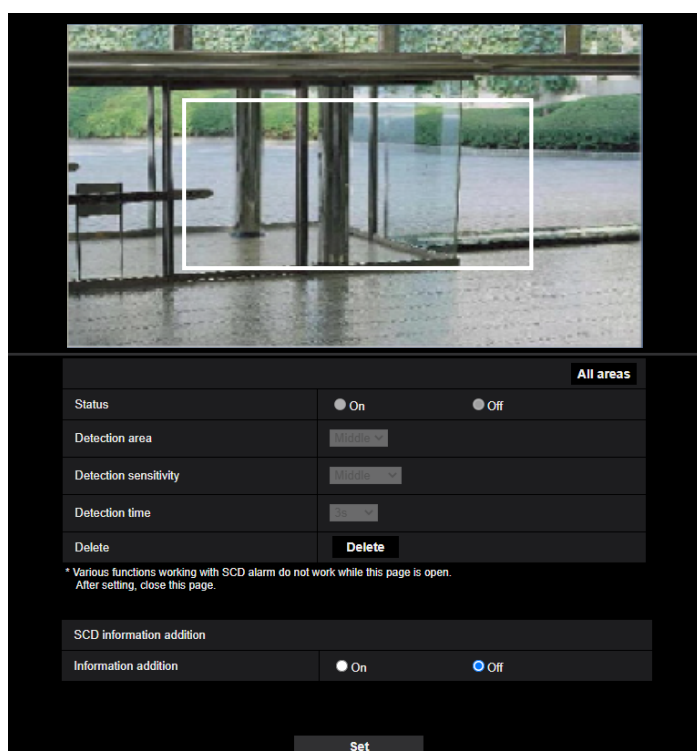

2. Adjust “Detection area” and “Detection sensitivity” selecting the pull-down menu. Refer to “3.9.7 Configure the SCD settings [SCD area]” for further information about the “Detection sensitivity” and “Detection area”. Change areas and the settings of “Detection area” and “Detection sensitivity” as necessary.
3. Click the [Set] button after completing the settings.

#### **IMPORTANT**

- The setting will not be applied unless the [Set] button is clicked.
4. To invalidate the SCD area, click the [Set] button after selecting “Off” for “Status”.
    - The outline of the invalidated SCD area will turn to a dotted line. When the SCD area is invalidated, no alarm will occur even when a motion can be recognized in the area.
  5. To delete the SCD area, click the [Delete] button.
    - The outline of the SCD area will disappear.
  6. Click the [Set] button.
    - The edited settings will be applied.

### 3.9.9 Configure the settings relating to the audio detection [Audio detection]

Click the [Audio detection] tab on the “Alarm” page. The settings relating to audio detection can be configured in this section.

#### IMPORTANT

- The alarm occurrence indication will be displayed when sound is detected by the audio detection function.
- The alarm occurrence indication will also be displayed when receiving an alarm input of a terminal alarm or a command alarm.
- Notification may be delayed in some network environments.
- The audio detection feature is not suitable to be used in situations where high reliability is constantly required (such as a prevention system). We are not responsible for any accidents or damages that may occur.

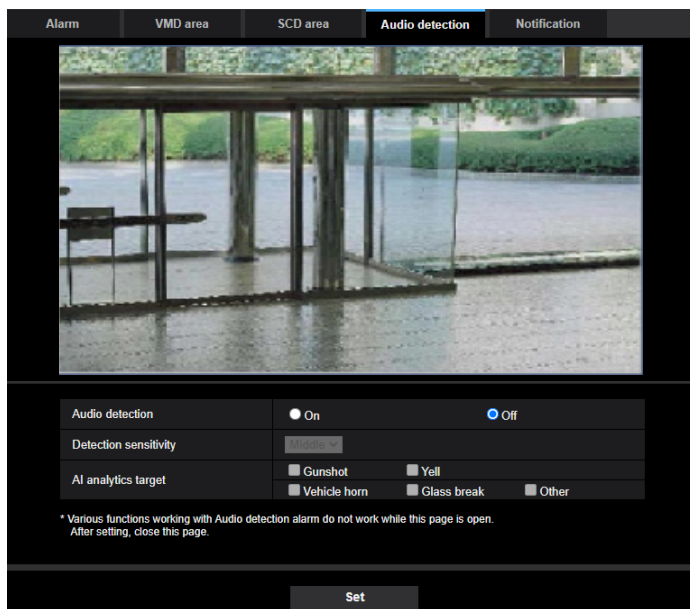

#### [Audio detection]

Select “On” or “Off” to determine whether or not to perform audio detection.

- **On:** Perform audio detection.
- **Off:** Does not perform audio detection.
- **Default:** Off

#### [Detection sensitivity]

Adjust the sensitivity of Volume from “Low”, “Middle”, or “High”.

- **Default:** Middle

#### Note

- When installing the camera indoors, it is recommended to select “Low” for [Detection sensitivity].

#### [AI analytics target] **S613xx** **S653xx**

Select the detection target for AI sound classification.

- **Gunshot:** Detects sound of gunshots, sound of explosions, impulsive sound and plosive sound.

- **Yell:** Detects screams and yells.
- **Vehicle Horn:** Detects car horns.
- **Glass Break:** Detects sound of glass breaking.
- **Other:** Detects other sounds than Gunshot, Yell, Vehicle Horn, Glass Break.

**Note**

- In the following cases, sounds to be detected may not be detected.
  - When the duration of Yell, Vehicle Horn or Glass Break is shorter than 1 second
  - When the difference between the sound to be detected and noise is less than 6dB
  - When raindrops directly hit the camera or microphone
- When multiple sounds of different types occurred at the same time, an alarm notification as triggered by only one type among these types will be provided.
- The message IDs of the TCP alarm notification of the AI sound classification are as follows. Use when registering the sound classification alarm using a recorder or ASM.
  - Gunshot: 70
  - Glass Break: 71
  - Vehicle Horn: 72
  - Yell: 73
  - Other: 55
- When a recorder or the like received an alarm notification of the AI sound classification, the recorder or the like cannot receive alarms during the alarm mask.

## 3.9.10 Configuration of the settings relating to alarm notification [Notification]

Click the [Notification] tab on the “Alarm” page. (→“3.2.1 How to display the setup menu”, “3.2.2 How to operate the setup menu”)

The settings relating to TCP alarm notification and HTTP alarm notification can be configured in this section.

### 3.9.10.1 Configure the settings relating to TCP alarm notification

#### [TCP alarm notification]

Select “On” or “Off” to determine whether or not to provide notification by TCP alarm notification according to the settings for the “Alarm” and “Diag.” checkboxes of “Destination of notification” below.

- When an alarm is detected (“Alarm”)
- When a notification of the remaining capacity of the SD memory card has been provided (“Diag.”)
- When the SD memory card has become full (“Diag.”)
- When the SD memory card cannot be recognized (“Diag.”)
- When an SD memory card write error occurred (“Diag.”)
- When the trial period of the extension software expired (“Diag.” field of “Destination of notification”)

**S613xx** **S653xx**

- **Default:** Off

#### **Note**

- When “On” is selected, notification of the alarm occurrence will be provided to the registered destination server addresses in order (to IP address 1 first, to IP address 8 last).

#### [Additional alarm data]

Determine whether or not to send notifications for VMD alarm detection area numbers with the TCP alarm notification by selecting On/Off.

- **Default:** Off

#### [Destination port]

Select a destination port for the TCP alarm notification from the following.

- **Available range:** 1 - 65535
- **Default:** 1818

The following port numbers are unavailable since they are already in use.

20, 21, 22, 23, 25, 42, 53, 67, 68, 69, 80, 110, 123, 161, 162, 443, 995, 1883, 8883, 10669, 10670

#### [Retry times]

Select a retry time for the TCP alarm notification.

- **Available range:** 0-30
- **Default:** 2

## Destination of notification

### [Address 1] - [Address 8]

Enter the destination IP address or host name of the TCP alarm notification from the following. Up to 8 destination server addresses can be registered.

- **[Alarm] checkbox:** When the checkbox is checked, the TCP alarm notification will be provided upon an alarm occurrence.

- **[Diag.] checkbox:** When the checkbox is checked, notification using TCP alarm notification will be provided in the following cases.
  - When notification of the remaining capacity of the SD memory card has been provided
  - When the SD memory card has become full
  - When the SD memory card cannot be recognized
  - When an SD memory card write error occurred
  - The trial period of the extension software expired **S613xx** **S653xx**
- **[Destination server address]:** Enter the destination server address or host name.
  - **Available characters:** Alphanumeric characters, the colon (:), the period (.), the underscore (\_), and the hyphen (-).

To delete the registered destination server address, click the [Delete] button respective to the desired destination server address.

#### **[Auto track cooperation]** **S613xx** **S653xx**

Select “On” or “Off” to determine whether or not to set “Auto track cooperation”.

When “On” is selected for “Auto track cooperation”, alarm notification is only implemented when the number of the “Alarm area No.” set in auto track alarm conforms with the alarm area number. Alarm notifications other than auto track alarms are not implemented. When using the auto track cooperation function, set the status of the alarm area of “Auto track alarm” to “On”.

- **Default:** Off

#### **[Notification per VMD area]** **U613xx** **U653xx**

Select “On” or “Off” to determine whether or not to set “Notification per VMD area”.

If “Notification per VMD area” is turned “On”, an alarm is notified only when “Alarm area No.” matches “Alarm area” configured by “VMD alarm”. Alarm notifications other than “VMD alarm” are not implemented. When using “Notification per VMD area”, select “On” for “Status” of the alarm area in VMD.

- **Default:** Off

#### **[Alarm area No.]**

- **Available range:** 1-4
- **Default:** 1

### **IMPORTANT**

- When entering the host name of the “Destination server address”, the DNS settings on the [Network] tab of the “Network” page must be configured. (→“3.11.1 Configure the network settings [Network]”)
- Confirm that the destination IP addresses are registered correctly. When a registered destination does not exist, notification may be delayed.

## **3.9.10.2 Configure the settings relating to HTTP alarm notification**

### **HTTP alarm notification**

#### **[Address 1] - [Address 5]**

Enter the destination IP address or host name of the HTTP alarm notification. Up to 5 destination server addresses can be registered.

- **Available characters:** Alphanumeric characters, the colon (:), the period (.), the underscore (\_), and the hyphen (-).
- **Default:** http://

#### **Example of entry:**

“http://IP address of the HTTP server + : (colon) + port number” or “http://Host name: (colon) + port number”  
 “https://IP address of the HTTP server + : (colon) + port number” or “https://Host name: (colon)+ port number”

#### [Alarm] checkbox

When the checkbox is checked, the HTTP alarm notification will be provided upon an alarm occurrence.

#### [Delete] button

When this button is clicked, all configured information, including the address, user name, password, and notification data, will be deleted.

#### [User name]

Enter the user name (login name) to access the HTTP server.

- **Available number of characters:** 0 - 63 characters
- **Unavailable characters:** " & ; \
- **Default:** None (blank)

#### [Password]

Enter the password to access the HTTP server.

- **Available number of characters:** 0 - 63 characters
- **Unavailable characters:** " &
- **Default:** None (blank)

#### Note

- "Basic" or "Digest" authentication will be performed when receiving authentication request of the HTTP server.

#### [Notification data]

Enter the notification data to add after the destination HTTP server addresses set in [Address 1] - [Address 5].

- **Available characters:** Alphanumeric characters
- **Default:** /cgi-bin/comalarm.cgi?CMD=01

#### Note

- When the HTTP alarm function is enabled, leakage of the HTTP server authentication information (user name and password) may occur in the network at the time of HTTP alarm notification.
- For "Address 1" to "Address 5", a total of 256 characters can be entered for the address (including "http://") and "Notification data".
- Make sure to enter a slash (/) as the first character for "Notification data".
- If the HTTP alarm notification fails, information about the failure will be added to the system log.
- Even if the [Set] button is clicked after deleting the contents of "Notification data", "/cgi-bin/comalarm.cgi?CMD=01" will be set.

#### <Example>

When `http://192.168.0.100` is set for the address and `/cgi-bin/comalarm.cgi?CMD=01` is set for "Notification data", an HTTP alarm notification such as `http://192.168.0.100/cgi-bin/comalarm.cgi?CMD=01` will be executed.

## 3.10 Configure the settings relating to the authentication [User mng.]

The settings relating to the authentication such as users and PCs restrictions for accessing the camera with a PC, mobile terminal or tablet device can be configured on the “User mng.” page.

The “User mng.” page has 4 tabs; the [User auth.] tab, the [Host auth.] tab, [IEEE 802.1X] tab and [Data encryption] tab.

### 3.10.1 Configure the settings relating to the user authentication [User auth.]

Click the [User auth.] tab on the “User mng.” page. (→“3.2.1 How to display the setup menu”, “3.2.2 How to operate the setup menu”)

The settings relating to the authentication of users who can access this camera from the PC, mobile terminal or tablet device can be configured on this page. Up to 24 users can be registered.

#### **Note**

- When user authentication has failed to pass (authentication error) 8 times within 30 seconds using the same IP address (PC), access to the unit will be denied for a while.

#### **[User auth.]**

Select “On” or “Off” to determine whether or not to authenticate the users.

- **Default:** On

#### **[Guest User]**

Select whether or not to set Guest User. If you select “Use”, you can set which functions are available or unavailable for guest users for whom user authentication has not been performed.

- **Default:** Use

#### **[Authentication]**

Set the user authentication method.

- **Digest or Basic:** Uses “Digest or Basic” authentication.
- **Digest:** Uses “Digest” authentication.
- **Basic:** Uses “Basic” authentication.
- **Default:** Digest

#### **Note**

- To enhance the security, it is recommended to select “Digest” for “Authentication method”. If “Digest or Basic” or “Basic” is selected, leakage of the user name and the password may occur.
- When the [Authentication] setting has been changed, close the web browser, and then access the camera again.

#### **[User name registration]**

At the time of new registration, register a new user name in [User name]. Click [▼] in “User name registration” to view registered users. Registered users are displayed as “Registered user name [Access level]”. (Example: admin [1])

If you click the [Change] button on the right, the selected user will be displayed in [User name], and you can change the password. By clicking the [Delete] button on the right, you can delete the selected user.

#### **[User name (1 to 32 characters)]**

Enter a user name.

### 3 Detailed settings

---

- **Available number of characters:** 1 - 32 characters
- **Unavailable characters:** " & ; ; \
- **Default:** None (blank)

#### Note

- When the user name already in use is entered and the [Set] button is clicked, the respective user information will be overwritten.

#### [Password (8 to 32 characters)] [Retype password]

Enter a password.

- **Available number of characters:** 8 - 32 characters
- **Unavailable characters:** " &
- **Default:** None (blank)

#### Note

- Distinguish between upper- and lower cases.
- For the password, use three or more types of characters from upper- and lowercase alphabetic characters, numeric characters, and symbols.
- Set the password which does not include the user name.

#### [Access Level]

Select the access level of the user from the following.

- **1. Administrator:** Allowed all available operations of the camera.
- **2. Camera control:** Allowed to control the camera. Functions selected for "Access level" can be operated.
- **3. Live only:** Allowed to display live view. Functions selected for "Access level" can be operated.
- **Default:** 3. Live only

#### [Access level]

Select the available functions based on the user access level (camera control, live view, guest user).

- **Default:**
  - Camera control: Check marks are placed in all check boxes other than "Preset position setting"
  - Live only: All are not checked
  - Guest User: All are not checked

#### Note

- **If you have set "User authentication" to "Off", and "Guest User" to "Not use":**  
The "Access Level" item cannot be set. And, while all the live operation buttons are displayed, the [Setup] buttons require authentication.
- **If you have set "User authentication" to "Off", and "Guest User" to "Use":**  
You can set the items for "Guest User".
- **If you have set "User authentication" to "On":**  
You cannot set the items for "Guest User".

You can set the following functions.

Live view selectable	Selecting an image displayed in the live view setting permissions
Listen	Mic Input (To PC) (when listening on a PC) setting permissions (→"Camera control panel - [Mic input volume (Camera to PC)]")
Talk	Audio output (From PC) (when talking from a PC) setting permissions (→"Camera control panel - [Audio output volume (PC to Camera)]")



Refresh Rate	JPEG format image refresh interval setting permissions (→“Stream information display”)
Snap shot	Snap shot operation permissions (→“Snap shot button”)
Playback of recording (Log disp.)	Log operation permissions (→[SD memory card] - [Log/Play])
Manual rec./Delete rec.	SD memory card save/delete permissions (→[SD memory card] - [Rec. on SD])
Preset	Operation permissions for moving the preset positions (→“PTZ panel - [Preset]”)
Pan/Tilt	Pan/tilt operation permissions (→“PTZ panel - Control pad/buttons”)
Zoom	Zoom operation permissions (→“PTZ panel - Control pad/buttons”)
Focus	Focus operation permissions (→“PTZ panel - Control pad/buttons”)
Auto mode	Auto mode operation permissions (→“PTZ panel - [Auto mode]”)
Brightness	Brightness setting permissions (→“Camera control panel - [Brightness]”)
AUX	AUX setting permissions (→“Camera control panel - [AUX] button”)
Preset position setting	Operation authority for “Preset position setting” (→“PTZ panel - [Preset]”)

### 3.10.2 Configure the settings relating to the host authentication [Host auth.]

Click the [Host auth.] tab on the “User mng.” page. (→“3.2.1 How to display the setup menu”, “3.2.2 How to operate the setup menu”)

The restriction settings of PCs (IP address) from accessing the camera can be configured on this page.

#### [Host auth.]

Select “On” or “Off” to determine whether or not to authenticate the host.

- **Default:** Off

#### **Note**

- Set “Host auth.” to “On” after registering the IP address of the PC.
- If “On” is selected for “User auth.”, the user authentication is required regardless of the host authentication settings.

#### [IP address]

Enter the IP address of the PC to be allowed to access the camera. Host name cannot be entered for the IP address.

#### **Note**

- When “IP address/subnet mask” is entered, it is possible to restrict PCs in each subnet. For example, when “192.168.0.1/24” is entered and “2. Camera control” is selected for the access level, the PCs whose IP address is between “192.168.0.1” - “192.168.0.254” can access the camera with the access level “2. Camera control”.
- When the IP address already in use is entered and the [Set] button is clicked, the respective host information will be overwritten.
- A “Set address” error message is displayed if the IP address of the PC has not been set properly. Check the set IP address of the PC again.

#### [Access level]

Select the access level of the host from the following.

1. Administrator/ 2. Camera control/ 3. Live only

Refer to “3.10.1 Configure the settings relating to the user authentication [User auth.]” for further information about the access level.

- **Default:** 3. Live only

#### [Host check]

From the pull-down menu of “Host check”, the registered host can be selected and the selected host’s IP address can be checked.

The registered IP address will be displayed with the access level.

(Example: 192.168.0.21 [1])

To delete the registered host, click the [Delete] button after selecting the IP address to be deleted.

### 3.10.3 Configure IEEE 802.1X [IEEE 802.1X]

Click the [IEEE 802.1X] tab on the “User mng.” page. (→For menu display and how to operate, refer to “3.2.1 How to display the setup menu”, “3.2.2 How to operate the setup menu”)

The settings relating to IEEE 802.1X can be configured on this page.

This feature can be used when constructing a secure network environment using the authentication LAN switch.

The procedures differ depending on the EAP method. Set up in the following procedures. If “On” is set for “IEEE 802.1X”, set it “Off” before starting setup.

User name and password are required for EAP-MD5 or EAP-PEAP.  
 User name and installation of private key, client certificate and CA certificate are required for EAP-TLS.  
 PEM(\*.pem) or DER(\*.der) format are supported for CA certificate.  
 PEM(\*.pem) or PFX(\*.pfx) format is supported for client certificate and private key.  
 Input password for private key when private key or certificate of PFX format is encrypted. Leave password blank when not encrypted.

#### [IEEE 802.1X]

Select “On” or “Off” to determine whether or not to perform port authentication using IEEE 802.1X.

- **Default:** Off

#### [User name]

Enter the user name to access the authentication LAN switch.

- **Available number of characters:** 1 - 32 characters
- **Unavailable characters:** " & ; \

#### [Password]

#### [Retype password]

Enter the password to access the authentication LAN switch.

- **Available number of characters:** 4 - 32 characters
- **Unavailable characters:** " &

**[CA Certificate] - [Certificate install]**

Install the root CA Certificate. Do not include the intermediate CA Certificate.  
Installation is possible only when “Off” is selected for “IEEE 802.1X”.

■ Specification of CA Certificate

Item	Specifications	Remarks
Data format	Format: PEM or DER	Extension: pem or der
Max. number of certificates included in the PEM format	1 pc.	—
Max. size of certificate	Approx. 10 kB	—

**[CA Certificate] - [Information]**

**not installed:** indicates that the certificate is not installed.

**CA certificate host name:** indicates that the certificate is installed.

**Expired:** indicates that the certificate is expired.

The details of CA Certificate can be checked with the [Confirm] button.

When the [Delete] button is clicked, the CA certificate will be deleted.

**Note**

- Check that the CA certificate has not expired. If you use a certificate that have expired, you may not be able to connect to authentication LAN switches.

**[Private key or Client Certificate including private key] - [Installation]**

Install the private key or Client Certificate that includes private key.  
Installation is possible only when “Off” is selected for “IEEE 802.1X”.

■ Specification of private key and Client Certificate including private key

Item	Specifications	Remarks
Data format	Format: PEM or PFX	Extension: pem or pfx
Key size [bit]	1024 /1536 /2048 /3072 /4096	—
Max. number of certificates included in the PEM format	6 pc.	—
Max. size of certificate (including intermediate CA Certificate)	Approx. 10 kB	—

**[Private key or Client Certificate including private key] - [Password]**

Enter the password if the private key is encrypted or the password is set for Client Certificate for the PFX method. Leave password blank when not encrypted.

**Available number of characters:** 0 - 30 characters

**[Private key or Client Certificate including private key] - [Install status of private key]**

**not installed:** Private key is not installed.

**installed:** Private key is installed.

When the [Delete] button is clicked, the private key will be deleted.

**[Client Certificate] - [Installation]**

Install the Client Certificate.

If signed by the intermediate CA Certificate, install the Client Certificate including the intermediate CA Certificate.

Installation is possible only when “Off” is selected for “IEEE 802.1X”.

### ■ Specification of Client Certificate

Item	Specifications	Remarks
Data format	Format: PEM	Extension: pem
Max. number of certificates included in the PEM format	6 pc.	—
Max. size of certificate (including intermediate CA Certificate)	Approx. 10 kB	—

#### [Client Certificate] - [Information]

**not installed:** indicates that the certificate is not installed.

**Certificate host name:** indicates that the certificate is installed.

**Expired:** indicates that the certificate is expired.

The details of Client Certificate can be checked with the [Confirm] button.

When the [Delete] button is clicked, the client certificate will be deleted.

#### Note

- Check that the client certificate has not expired. If you use a certificate that has expired, you may not be able to connect to authentication LAN switches.

#### [EAP method]

Select the authentication method from EAP-MD5, EAP-PEAP or EAP-TLS.

##### EAP-MD5/EAP-PEAP

1. Select "On" for "IEEE 802.1X".
2. Select "EAP-MD5" or "EAP-PEAP" for "EAP method".
3. Click the [Set] button after entering the user name, the password, and confirming the password.

##### EAP-TLS

1. Click the [Choose File] button of "CA Certificate" - "Certificate install". Then, select a CA Certificate and click the [Execute] button. The host name (CommonName) designated when created the certificate will be displayed at "Information".
2. Click the [Choose File] button of "Private key or Client Certificate including private key", and select a private key or Client Certificate that includes Private key.
3. Enter the password if the private key is encrypted or the password is set for Client Certificate for the PFX method. Leave password blank when not encrypted.
4. Click the [Execute] button to start installation.  
"installed" will be displayed for "Install status of private key".  
In the case of selecting Client Certificate including the private key, "installed" will be displayed for "Client Certificate" - "Information" as well.
5. When the private key is installed in step 2, select a Client Certificate after clicking the [Choose File] button of "Client Certificate", and then click the [Execute] button. The host name (CommonName) designated when created the certificate will be displayed at "Information".
6. Select "On" for "IEEE 802.1X". Then, select "EAP-TLS" for "EAP method".
7. Enter the user name registered to the server in "User name". Then, click the [Set] button.  
If no user name is registered to the server, enter an arbitrary user name.  
"Password" and "Retype password" can be left blank.

#### Note

- To delete each certificate, set [IEEE 802.1X] to "Off".
- Check that the CA certificate and client certificate have not expired. If you use certificates that have expired, you may not be able to use the port notification feature.

#### Example of CA Certificate check screen

CA Certificate - Confirm	
Common Name	192.168.1.1
Country	JP
State	
Locality	
Organization	
Organizational Unit	

**Close**

#### Example of Client Certificate check screen

Client Certificate - Confirm	
Common Name	192.168.1.1
Country	JP
State	Osaka
Locality	Osaka
Organization	Person
Organizational Unit	Development

**Close**

#### **IMPORTANT**

- After selecting “On” for “IEEE 802.1X”, if access to the camera fails for some reason, connect to a switch or port without authentication. It disables IEEE 802.1X, and enables access to the camera.
- If the Client Certificate includes intermediate CA Certificate, the Client Certificate needs to come first, then the intermediate CA Certificate.
- When a certificate over 10 Kbyte is installed, no error will be displayed during installation. However, an error may occur at the time of connection.

### 3.10.4 Configure the data encryption settings [Data encryption]

Click [Data encryption] on the “User mng.” page. (→For menu display and how to operate, refer to “3.2 Display the setup menu from a PC”, “3.2.2 How to operate the setup menu”)

The settings relating to the data encryption can be configured in this section.

Click the “+” mark on the left of the setup menu to expand the respective item, and enable detailed settings.

Click the “-” mark on the left of an expanded item to return to the screen displayed before the item was expanded.



#### [Data encryption (Batch change)]

Select “On” or “Off” to determine whether or not to activate data encryption.

- **On:** Activates data encryption. Encrypts Stream(1), Stream(2), Stream(3), Stream(4), JPEG(1), JPEG(2), and “AAC-LC” audio.
- **Off:** Deactivates data encryption.
- **Default:** Off

#### [Stream(1)], [Stream(2)], [Stream(3)], [Stream(4)], [JPEG(1)], [JPEG(2)]

Select “On” or “Off” independently for Stream(1), Stream(2), Stream(3), Stream(4), JPEG(1) and JPEG(2) to determine whether or not to activate data encryption.

- **Default:** Off

#### [Encryption password], [Retype encryption password]

Set the password for data encryption.

- **Available number of characters:** 4 - 16 characters
- **Unavailable characters:** " &

#### **IMPORTANT**

- The initial password is displayed in “MAC address” on the [Upgrade] screen of the [Maintenance] tab. When using data encryption, make sure to change the password.
- When “On” is selected for data encryption, it is recommended to set the total bit rate of the stream becomes 16 Mbps or less.
- When “On” is selected, images cannot be monitored using a browser. Please use our supported devices to monitor encrypted images.
- The encrypted MP4 files and JPEG images cannot be viewed on the image playing screen in the browser. Download it to a PC and use the decryption tool to confirm it. For information about the decryption tool, refer to our technical information website <Control No.: C0310>.
- When “On” is selected for data encryption, “16 Screens” in the “Layout” pull-down menu on the multi-screen becomes unselectable.

### 3 Detailed settings

#### Note

- On the [Live view] pull-down menu on the “Live” page or the setup menu, <Encrypted> will be displayed for streams that have data encryption enabled.  
Example: When Stream 1 and JPEG(2) are data encrypted
  - [Live view] pull-down menu on the “Live” page

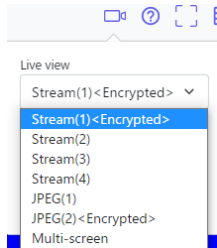

- Pull-down menu in the setup menu

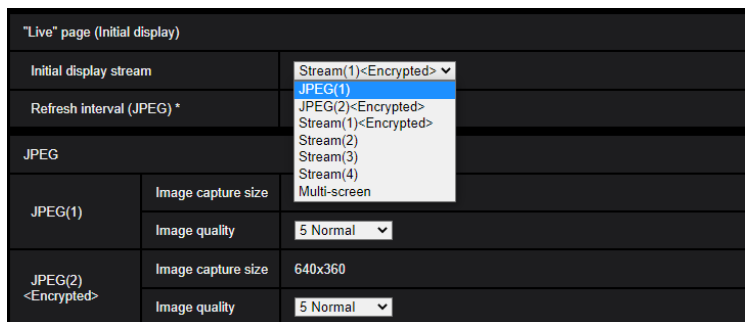

- When [Data encryption (Batch change)] is “On”, “AAC-LC” audio is data encrypted (“G.726” and “G.711” are not data encrypted). To encrypt both the image and audio, set [Data encryption (Batch change)] to “On” and set [Audio input encoding format] to “AAC-LC”.
- For encrypted MP4 files and JPEG images, you can use the decryption tool to confirm the images.



## 3.11 Configuring the network settings [Network]

The network settings can be configured on the “Network” page.  
The “Network” page has the [Network] tab and the [Advanced] tab.

### 3.11.1 Configure the network settings [Network]

Click the [Network] tab on the “Network” page. (→“3.2.1 How to display the setup menu”, “3.2.2 How to operate the setup menu”)

The following information is required to configure the network settings. Contact the network administrator or your Internet service provider.

- IP address
- Subnet mask
- Default gateway (when using the gateway server/router)
- HTTP port
- Primary DNS address, Secondary DNS address (when using DNS)

## IPv4 network

### [Network Settings]

Select the method of how to configure the IP address from the following.

- **Static:** The IP address is configured by entering manually on “IP address(IPv4)”.
- **DHCP:** The IP address is configured using the DHCP function. If the camera cannot acquire an IP address from the DHCP server, set the IP address to “192.168.0.10”. After that, once an IP address is acquired from the DHCP server, change it to that IP address.
- **Auto(AutoIP):** The IP address is configured using the DHCP function. When the DHCP server is not found, the IP address is automatically configured.
- **Auto(Advanced):** Using the DHCP function, network address information is referred to, and an unused IP address is configured to the camera as a static IP address. The configured IP address is automatically determined within the subnet mask range by the camera. When the DHCP server is not found, the IP address is set to 192.168.0.10.
- **Default:** DHCP

### Note

- When “Auto(AutoIP)” is selected and the IP address cannot be obtained from the DHCP server, an IP address not used in the same network will be searched within 169.254.1.0 - 169.254.254.255.

### [IP address(IPv4)]

When not using the DHCP function, enter the IP address of the camera. Do not enter an IP address already in use (for the PCs and the other network cameras).

- **Default:** 192.168.0.10

### Note

- Multiple IP addresses are unavailable even when using the DHCP function. Refer to the network administrator for further information about the settings of the DHCP server.

### [Subnet mask]

When not using the DHCP function, enter the subnet mask of the camera.

- **Default:** 255.255.255.0

#### [Default gateway]

When not using the DHCP function, enter the default gateway of the camera.

- **Default:** 192.168.0.1

#### **Note**

- Multiple IP addresses for the default gateway are unavailable even when using the DHCP function. Refer to the network administrator for further information about the settings of the DHCP server.

#### [DNS]

Determine how to set the address of the DNS server by selecting “Auto” (obtain the address automatically) or “Manual” (enter the address of the DNS server). When “Manual” is selected, it is necessary to configure the settings for the DNS.

When using the DHCP function, it is possible to obtain the DNS address automatically by selecting “Auto”. Refer to the network administrator for further information about the settings.

- **Default:** Auto

#### [Primary server address], [Secondary server address]

When “Manual” is selected for “DNS”, enter the IP address of the DNS server.

Refer to the network administrator about the IP address of the DNS server.

## IPv6 network

#### [Manual]

Select “On” or “Off” to determine whether or not to manually configure the IP address for IPv6 network (IPv6 address).

- **On:** Enter an IPv6 address manually.
- **Off:** Manual entry of an IPv6 address will become unavailable.
- **Default:** Off

#### [IP address(IPv6)]

When “On” is selected for “Manual”, manual entry of the IPv6 address is required. Do not enter an address already in use.

#### **Note**

- When connecting to the manually configured IPv6 address beyond the router, use an IPv6 compatible router and turn on the automatic IPv6 address assignment function. In this case, it is necessary to configure IPv6 address including prefix information provided from the IPv6 compatible router. Refer to the manuals provided with the router for further information.

#### [Default gateway]

When “On” is selected for “Manual” of IPv6 network, enter the default gateway of IPv6 network of the camera.

- **Default:** None (blank)

#### [DHCPv6]

Select “On” or “Off” to determine whether or not to use the IPv6 DHCP function.

Configure the DHCP server not to assign the same IP addresses used for the other network cameras and PCs whose IP address is unique. Refer to the network administrator for further information about the settings of the server.

- **Default:** Off

#### [Primary DNS server address], [Secondary DNS server address]

Enter the IPv6 address of the DNS server. Refer to the network administrator about the IPv6 address of the DNS server.

## Common

### [HTTP port]

Assign the port numbers independently.

- **Available port number:** 1 - 65535
- **Default:** 80

The following port numbers are unavailable since they are already in use.

20, 21, 22, 23, 25, 42, 53, 67, 68, 69, 110, 123, 161, 162, 443, 554, 995, 1883, 8883, 10669, 10670, 59000 - 61000

### Note

- Some ports may not be accessible depending on the browser. If you cannot access to the camera from the browser, please access to the camera via HTTPS or change the HTTP port number of the camera using iCT.

### [Line speed]

Select the line speed for data transmission from the following. It is recommended to use with the default "Auto".

- **Auto:** Line speed will be applied automatically.
- **100M-Full:** 100 Mbps full-duplex
- **100M-Half:** 100 Mbps half-duplex
- **10M-Full:** 10 Mbps full-duplex
- **10M-Half:** 10 Mbps half-duplex
- **Default:** Auto

### [Max RTP packet size]

Select "Unlimited(1500byte)" or "Limited(1280byte)" to determine whether or not to restrict the RTP packet size when viewing images from the camera using the RTP protocol. It is recommended to use with the default "Unlimited(1500byte)".

When the RTP packet size is restricted in the network line in use, select "Limited(1280byte)". Refer to the network administrator for further information about the maximum packet size in the network line.

- **Default:** Unlimited(1500byte)

### [HTTP max segment size(MSS)]

Select "Unlimited(1460byte)", "Limited(1280byte)", or "Limited(1024byte)" to determine whether or not to restrict the maximum segment size (MSS) when viewing images from the camera using the HTTP protocol. We recommended that you use this feature with the default setting.

When the MSS is restricted in the network line in use, select "Limited(1024byte)" or "Limited(1280byte)". Refer to the network administrator for further information about the MSS in the network line.

- **Default:** Unlimited(1460byte)

### [Bandwidth control(bit rate)]

Select the total bit rate for data transmission from the following.

Unlimited/ 64kbps/ 128kbps/ 256kbps/ 384kbps/ 512kbps/ 768kbps/ 1024kbps/ 2048kbps/ 4096kbps/ 6144kbps/ 8192kbps/ 10240 kbps/ 15360 kbps/ 20480 kbps/ 25600 kbps/ 30720kbps/ 35840kbps/ 40960 kbps/ 51200kbps

- **Default:** 51200kbps

### Note

- When selecting "64kbps", select "Off" for "Audio transmission mode" on the [Audio] tab. (→"3.6.5 Configure the settings relating to audio [Audio]")

### 3 Detailed settings

- When “Bandwidth control(bit rate)” is set low, taking a picture using the snap shot button may not function depending on the usage environment. In this case, select “JPEG” on the “Live” page and take a picture with the snap shot button using the lowest possible image capture size.

#### [Easy IP Setup accommodate period]

Select “20min” or “Unlimited” to determine how long the network setting operation using the “IP Setting Software” can be allowed.

- **20min:** The network setting operation using the “IP Setting Software” are allowed for 20 minutes since the camera starts up.
- **Unlimited:** The network setting operation using the “IP Setting Software” are allowed without time limitation.
- **Default:** 20min

#### Note

- The camera information display using the “IP Setting Software” is allowed without time limitation, and camera images can be opened.
- Refer to the network administrator for the addresses of each server.
- To access the camera via the Internet by connecting the camera to a router, it is necessary to assign a respective HTTP port number for each camera and address translation by using the port forwarding function of the router. For further information, refer to the operating instructions of the router in use.
- The port forwarding function changes a global IP address to a private IP address, and “Static IP masquerade” and “Network Address Translation (NAT)” have this function. This function is to be set in a router.

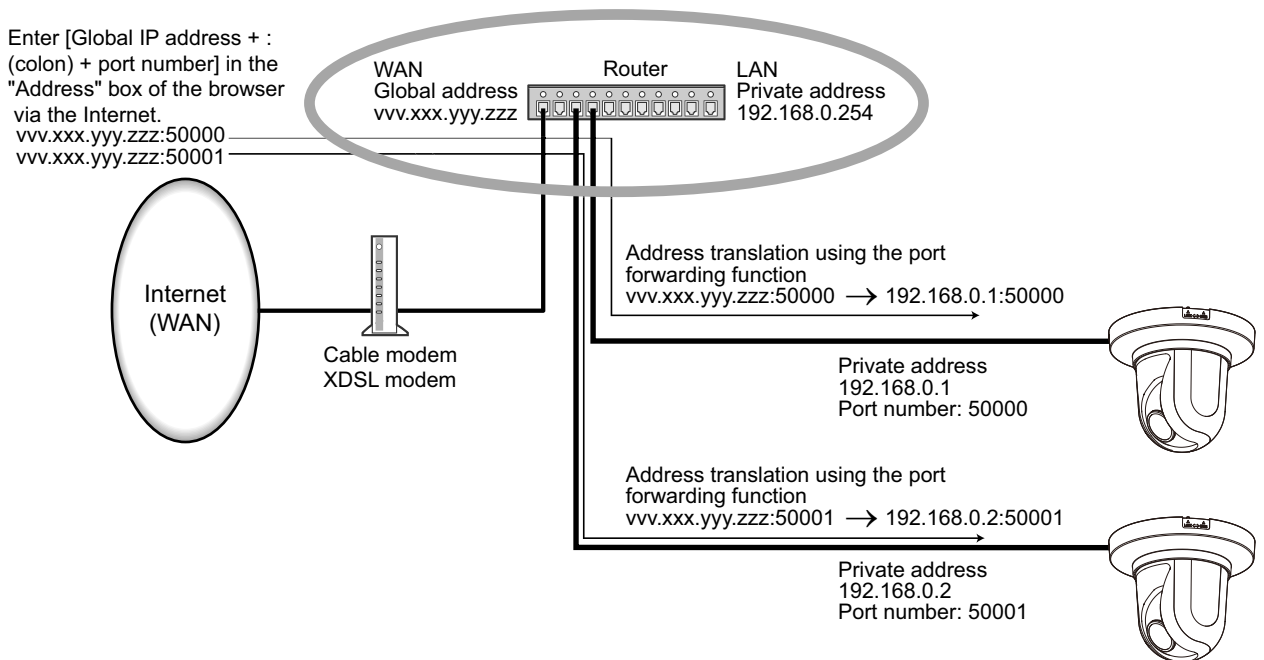

#### [FTP access to camera]

Select “Allow” or “Forbid” to determine whether to allow or forbid the FTP access to camera.

- **Allow:** FTP access to camera is allowed.
- **Forbid:** FTP access to camera is forbidden.
- **Default:** Forbid

**IMPORTANT**

- If you allow FTP access to the camera, there is a possibility that authentication information (user names, passwords, etc.) will be leaked when accessing the camera from a PC.

**[ONVIF®]**

Select “On” or “Off” to determine whether to enable the ONVIF function.

- **On:** The ONVIF function is enabled.
- **Off:** The ONVIF function is disabled.
- **Default:** On

**Note**

- ONVIF is the trademark of ONVIF, Inc.

## 3.11.2 Configure advanced network settings [Advanced]

Click the [Advanced] tab on the “Network” page. (→“3.2.1 How to display the setup menu”, “3.2.2 How to operate the setup menu”)

The settings related to SMTP (E-mail), FTP/SFTP, NTP, UPnP, HTTPS, DDNS, SNMP, QoS, SRTP, MQTT, LLDP can be configured in this section.

You can move to the setting page of a setting item by clicking the corresponding link for that setting item.

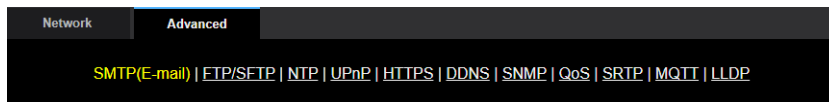

### 3.11.2.1 Configure the settings related to sending E-mails

#### [E-mail notification]

Select “On” or “Off” to determine whether or not to provide notification by E-mail according to the settings for the “Alarm” and “Diag.” checkboxes of “Destination of notification” below.

- When an alarm is detected (“Alarm”)
- When a notification of the remaining capacity of the SD memory card has been provided (“Diag.”)
- When the SD memory card has become full (“Diag.”)
- When the SD memory card cannot be recognized (“Diag.”)
- **Default:** Off

#### [Alarm image attachment]

Select “On” or “Off” to determine whether or not to attach an image to the E-mail to be sent when an alarm is detected.

- **Default:** Off

#### [Image capture size]

Select the image capture size of images attached to an alarm E-mail from the following.

JPEG(1)/JPEG(2)

- **Default:** JPEG(2)

#### [SMTP server address]

Enter the IP address or the host name of the SMTP server used to send E-mails.

- **Available number of characters:** 1 - 128 characters
- **Available characters:** Alphanumeric characters, the colon (:), the period (.), the underscore (\_), and the hyphen (-).

#### [SMTP port]

Enter the port number to which E-mails are sent.

- **Available port number:** 1-65535
- **Default:** 25

The following port numbers are unavailable since they are already in use.

20, 21, 22, 23, 42, 53, 67, 68, 69, 80, 110, 123, 161, 162, 443, 995, 1883, 8883, 10669, 10670

#### [POP server address]

When “POP before SMTP” is selected for “Type”, enter the IP address or the host name of the POP server.

- **Available number of characters:** 1 - 128 characters
- **Available characters:** Alphanumeric characters, the colon (:), the period (.), the underscore (\_), and the hyphen (-).

**IMPORTANT**

- When entering the host name for “SMTP server address” or “POP server address”, it is necessary to configure the DNS settings on the [Network] tab of the “Network” page. (→“3.11.1 Configure the network settings [Network]”)

**[Authentication]**• **Type**

Select the authentication method to send E-mails from the following.

- **None:** It is not necessary to clear any authentication to send E-mails.
- **POP before SMTP:** It is necessary to first clear the POP server authentication to use the SMTP server to send E-mails.
- **SMTP:** It is necessary to clear the SMTP server authentication to send E-mails.
- **Default:** None

**Note**

- When you don’t know the authentication method to send E-mails, refer to the network administrator.
- **User name**  
Enter the user name to access the server.
  - **Available number of characters:** 0 - 32 characters
  - **Unavailable characters:** " & ; \
- **Password**  
Enter the password to access the server.
  - **Available number of characters:** 0 - 128 characters
  - **Unavailable characters:** " &

**[Sender’s E-mail address]**

Enter the E-mail address of a sender.

The entered E-mail address will be displayed in the “From” (sender) line of the sent E-mails.

- **Available number of characters:** 3 - 128 characters
- **Available characters:** Alphanumeric characters, the at sign (@), the period (.), the underscore (\_), and the hyphen (-).

**[SSL]**

Select “On” if you want to use SSL encryption when sending E-mail notifications for alarm occurrences or the “Diag.” function. When you select “On”, the authentication method will be set to “SMTP”. Set the user name and the password used for authentication.

- **Default:** Off

**Note**

- Some SMTP servers may not support SSL.
- SSL supports SMTP over SSL, but STARTTLS is not supported.
- When “On” is selected, the SMTP port number may need to be set to 465. Ask your Internet service provider for the appropriate settings.

**[Address 1] - [Address 4]**

Enter the destination E-mail address. Up to 4 destination E-mail addresses can be registered.

- **Available number of characters:** 3 - 128 characters
- **Available characters:** Alphanumeric characters, the at sign (@), the period (.), the underscore (\_), and the hyphen (-).  
To delete the registered address, click the [Delete] button respective to the desired address.
- **Terminal 1:** Notify by e-mail when an alarm occurs in Terminal 1.
- **Terminal 2:** Notify by e-mail when an alarm occurs in Terminal 2.

- **Terminal 3:** Notify by e-mail when an alarm occurs in Terminal 3.
- **VMD:** Notify by e-mail when motion is detected.
- **SCD:** Notify by e-mail when SCD has occurred.
- **Command alarm:** Notify by e-mail when a command alarm is entered.
- **Audio detection:** Notify by e-mail when audio detection has occurred.
- **Diag.:**
  - When a notification of the remaining capacity of SD memory card has been provided
  - When the SD memory card has become full
  - When the SD memory card cannot be recognized
- Auto track **S613xx** **S653xx**: Notify by e-mail when an auto track alarm occurs.

**Note**

- In the diagnostic e-mail notification sent when you have checked the destination of notification [Diag.] field, the contents of the [E-mail subject] and [E-mail body] which are set later are not changed.

**[E-mail subject(Alarm)]**

Enter the E-mail subject.

- **Available number of characters:** 0 - 50 characters
- **Use the camera title:** The camera title will be displayed in the e-mail subject.
- **Cause of alarm:** Adds the cause of alarm to the E-mail subject.

**[E-mail subject(Diag.)]**

Enter the diagnostic e-mail subject.

- **Available number of characters:** 0 - 50 characters
- **Use the camera title:** The camera title will be displayed in the e-mail subject.

**[E-mail body(Alarm)]**

Enter the E-mail body.

- **Available number of characters:** 0 - 200 characters
- **Cause of alarm:** The cause of alarm %p% is added in the e-mail body. %p% is replaced by the cause of alarm and sent.
  - For VMD alarm: "VMD"
  - For SCD alarm: "SCD"
  - For auto track alarm: "AT" **S613xx** **S653xx**
  - For intruder alarm by AI-VMD: "INT" **S613xx** **S653xx**
  - For loitering alarm by AI-VMD: "LOI" **S613xx** **S653xx**
  - For direction alarm by AI-VMD: "DIR" **S613xx** **S653xx**
  - For cross line alarm by AI-VMD: "CLD" **S613xx** **S653xx**
  - For terminal alarm: Terminal name set in "Terminal 1", "Terminal 2", and "Terminal 3" of "Terminal name". (Example: If the name of Terminal 1 is "Terminal 1", it is "Terminal 1")
  - For command alarm: "CMD"
  - For audio detection alarm: "Audio detection" **U613xx** **U653xx**
  - For audio detection alarm (AI sound classification, Gunshot): "Audio detection Gunshot" **S613xx** **S653xx**
  - For audio detection alarm (AI sound classification, Yell): "Audio detection Yell" **S613xx** **S653xx**
  - For audio detection alarm (AI sound classification, Vehicle Horn): "Audio detection Vehicle Horn" **S613xx** **S653xx**
  - For audio detection alarm (AI sound classification, Glass Break): "Audio detection Glass Break" **S613xx** **S653xx**
  - For audio detection alarm (AI sound classification, Other): "Audio detection" **S613xx** **S653xx**



- **Occurrence time:** The time of occurrence %t% will be added to the e-mail body. %t% will be replaced by the time of occurrence of the alarm (HH:MM:SS) and sent.
- **Default:**
  - Cause of alarm: Checked
  - Occurrence time: Checked
  - E-mail body: The %p% alarm was occurred at %t%.

#### Note

- Notification E-mail will be sent with the message “The capacity of the SD memory card is full.” when the SD memory card has become full, or “The SD memory card cannot be detected.” when mounting of the SD memory card failed.
- Entering alternative text into the E-mail body automatically adds the event or time when an alarm occurs.  
Alternative text cause of alarm: %p%, occurrence time: %t%  
(Examples of use)  
After setting the following characters in the E-mail body, there is a VMD alarm occurrence at the time 19:13:24.  
E-mail body settings: %p% alarm occurred at %t%.  
Sent E-mail body: “A “VMD” alarm occurred at 19:13:24.”  
When the body of the email is empty, the language that the email is sent in is determined by “Menu language” of “Basic”. If “Japanese” is specified, email is sent in Japanese. If another language is specified, email is sent in English.

#### [Terminal 1 (Up to 10 characters)]

Enter the name of Terminal 1 used in the cause of alarm in the e-mail body.

- **Unavailable characters:** " &
- **Default:** Terminal1

#### [Terminal 2 (Up to 10 characters)]

Enter the name of Terminal 2 used in the cause of alarm in the e-mail body.

- **Unavailable characters:** " &
- **Default:** Terminal2

#### [Terminal 3 (Up to 10 characters)]

Enter the name of Terminal 3 used in the cause of alarm in the e-mail body.

- **Unavailable characters:** " &
- **Default:** Terminal3

#### Example of e-mail notification

An e-mail format in which the camera title check box is specified in the e-mail subject and the cause of alarm/ occurrence time are specified in the e-mail body

Example e-mail:

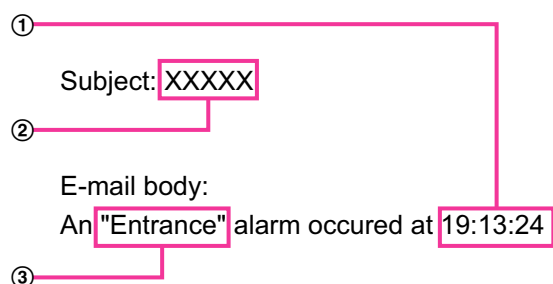

### 3 Detailed settings

- ① The alarm occurrence time is assigned.
- ② The camera title is used as the e-mail subject.
- ③ The name set for Terminal names 1 to 3, which is the cause of alarm, is assigned to the name.

#### 3.11.2.2 Add FTP/SFTP image transmission function

FTP and SFTP are protocols used for file transfer and they are used when transmitting images to the server. Images can safely be transmitted to the server with SFTP using data stream encrypted by SSH (Secure Shell). It has the following two transmission functions.

- Send images when an alarm occurs
- Send images periodically

The screenshot shows the 'Advanced' settings page for network services. The 'FTP/SFTP' tab is selected. The settings are organized into several sections:

- Transmission protocol:** Radio buttons for FTP and SFTP (SFTP is selected).
- Alarm setting:** Radio buttons for On and Off (Off is selected).
- Alarm image transmission:** Radio buttons for On and Off (Off is selected).
- Directory name:** A text input field.
- File name:** Checkboxes for Terminal 1, Terminal 2, Terminal 3, VMD, SCD, Auto track, Command alarm, and Audio detection. A note states: '\* For alarms by the "Ext. software", alarm images will be transmitted only by configuring the alarm image SFTP transmission.'
- FTP transmission retry:** Radio buttons for On and Off (Off is selected).
- Pre alarm:** Fields for Transmission interval, Maximum number of images, and Recording duration (0s).
- Post alarm:** Fields for Transmission interval, Number of images, and Recording duration (100s).
- Image capture size:** A dropdown menu set to JPEG(2) (640x360).
- Periodic transmission settings:** Radio buttons for On and Off (Off is selected).
- Periodic image transmission:** Radio buttons for On and Off (Off is selected).
- Directory name:** A text input field.
- File name:** Radio buttons for Name w/time&date and Name w/o time&date (Name w/o time&date is selected).
- Transmission interval:** A dropdown menu set to 15.
- Image capture size:** A dropdown menu set to JPEG(2) (640x360).
- SFTP server setting:** Fields for SFTP server address (Example of entry: 192.168.0.10), Port number (22, range 1-65535), Host key hash (SHA256, Example of entry: dqVcdVZ/2ySO5tz/R6YR+rbW6dnap6P/43uIMV0cf0), User name, and Password.
- FTP server setting:** Fields for FTP server address (Example of entry: 192.168.0.10), User name, Password, Control port (range 1-65535), and FTP mode (Passive and Active radio buttons).

A 'Set' button is located at the bottom of the page.

**[Transmission protocol]**

Select FTP or SFTP for protocol to be used to transmit to the destination server.

- **SFTP:** SFTP is used as protocol to communicate with the server.
- **FTP:** FTP is used as protocol to communicate with the server.
- **Default:** SFTP

**IMPORTANT**

- When FTP is selected for [Transmission protocol], leakage of the FTP server authentication information (user name and password) may occur in the network at the time of transmitting images to the FTP server.

**Alarm setting****[Alarm image transmission]**

Select “On” or “Off” to determine whether or not to transmit the alarm image to the server.

- **Default:** Off

**[Directory name]**

Enter the directory name where the alarm images are to be saved.

For example, enter “/ALARM” to designate the directory “ALARM” under the root directory of the server.

- **Available number of characters:** 1 - 256 characters
- **Unavailable characters:** " & ;

**[File name]**

Enter the file name used for the alarm image to be transmitted to a server. The file name will be as follows.

- **File name:** ["Entered file name" + "Time and date (year/ month/ day/ hour/ minute/ second)"] + "Serial number"
- **Available number of characters:** 1 - 32 characters
- **Unavailable characters:** " & \* / : ; < > ? \ |
- **Terminal 1:** Transmit the image to the server when an alarm occurs in Terminal 1.
- **Terminal 2:** Transmit the image to the server when an alarm occurs in Terminal 2.
- **Terminal 3:** Transmit the image to the server when an alarm occurs in Terminal 3.
- **VMD:** Transmit the image to the server when motion is detected.
- **SCD:** Transmit the image to the server when SCD (scene change detection) occurs.
- **Auto track** **S613xx** **S653xx**: Transmit the image to the server when an auto track occurs.
- **Audio detection:** Transmit the image to the server when audio detection occurs.
- **Command alarm:** Transmit the image to the server when a command alarm is entered.

**[FTP transmission retry]**

Select “On” or “Off” to determine whether or not to resend failed FTP transmissions.

- **On:** If transmission fails, transmissions are resent until they are successfully sent.
- **Off:** If transmission fails, the image that failed to be sent is discarded and the next image is sent.
- **Default:** Off

**Note**

- When SFTP is selected for [Transmission protocol], the FTP transmission retry setting cannot be set.

**[Pre alarm]**

- **Transmission interval**

Select the update interval of images before an alarm occurs from the following.

When 30fps mode or 15fps mode is selected for “Image capture mode”:

### 3 Detailed settings

0.1fps/ 0.2fps/ 0.33fps/ 0.5fps/ 1fps

When 25fps mode or 12.5fps mode is selected for “Image capture mode”:

0.08fps/ 0.17fps/ 0.28fps/ 0.42fps/ 1fps

- **Default:** 1fps

- **Maximum number of images**

Select the number of images to be transmitted from the following.

0pics/ 1pic/ 2pics/ 3pics/ 4pics/ 5pics/ 6pics\*/ 7pics\*/ 8pics\*/ 9pics\*/ 10pics\*/ 20pics\*/ 30pics\*/ 40pics\*/ 50pics\*

- **Default:** 0pics

- **Recording duration**

The recording duration, which changes according to the configured “Transmission interval” and “Maximum number of images”, of images recorded before an alarm occurs is displayed.

#### Note

- When “JPEG(1)” is selected for the capture size of the image to be transmitted, pre alarm is unavailable if the image capture size of “JPEG(1)” is larger than “1920x1080”.
- When “On” is selected for “Image compression rate upon alarm detection”, only post alarm recorded images are compressed. Compression is not applied to pre alarm recorded images.
- When a selection with an asterisk (\*) on the right of it is selected for “Maximum number of images” of “Pre alarm”, the specified number of images may not be able to be sent depending on the image capture size and image quality. The following table shows the maximum number of images that can be sent for pre alarm.

		Image quality									
		0	1	2	3	4	5	6	7	8	9
Image capture size	1280x960	5	6	7	8	10	10	10	20	30	40
	1280x720	7	8	10	10	10	20	20	30	40	50
	VGA	10	20	20	30	30	40	50	50	40	50
	640x360	20	30	40	50	50	50	50	50	50	50
	QVGA	40	50	50	50	50	50	50	50	50	50
	320x180	50	50	50	50	50	50	50	50	50	50

#### [Post alarm]

- **Transmission interval**

Select the transmission interval for the alarm image transmission to the FTP server from the following.

When 30fps mode or 15fps mode is selected for “Image capture mode”:

0.1fps/ 0.2fps/ 0.33fps/ 0.5fps/ 1fps

When 25fps mode or 12.5fps mode is selected for “Image capture mode”:

0.08fps/ 0.17fps/ 0.28fps/ 0.42fps/ 1fps

- **Default:** 1fps

- **Number of images**

Select the number of images to be transmitted from the following.

1pic/ 2pics/ 3pics/ 4pics/ 5pics/ 6pics/ 7pics/ 8pics/ 9pics/ 10pics/ 20pics/ 30pics/ 50pics/ 100pics/ 200pics/ 300pics/ 500pics/ 1000pics/ 1500pics/ 2000pics/ 3000pics

- **Default:** 100 pics

- **Recording duration**

Approximate time to be taken to save the set “Number of images” with the set “Transmission interval” will be displayed.

**[Image capture size]**

Select the image capture size of images transmitted when an alarm occurs from the following.

JPEG(1)/JPEG(2)

- **Default:** JPEG(2)

**Periodic image transmission****[Periodic image transmission]**

Select “On” or “Off” to determine whether or not to transmit images using the periodic image transmission function.

When “On” is selected, it is necessary to configure the settings of the server.

- **Default:** Off

**IMPORTANT**

- When using the periodic image transmission, it is necessary to configure the schedule settings of FTP/SFTP periodic image transmission on the [Schedule] tab of the “Schedule” page. (→“3.4.2.9 Schedule: Configure FTP/SFTP periodic image transmission (FTP/SFTP periodic image transmission setup menu)”)

**[Directory name]**

Enter the directory name where the images are to be saved.

For example, enter “/img” to designate the directory “img” under the root directory of the server.

- **Available number of characters:** 1 - 256 characters
- **Unavailable characters:** " & ;
- **Default:** None (blank)

**[File name]**

Enter the file name (name of the image file to be transmitted) and select the naming option from the following.

- **Name w/time&date:** File name will be [“Entered file name” + “Time and date (year/ month/ day/ hour/ minute/ second)” + “Serial number (starting from 00)”].
- **Name w/o time&date:** File name will be the characters entered for “File name” only. When “Name w/o time&date” is selected, the file will be overwritten each time a file is newly transmitted.
- **Available number of characters:** 1 - 32 characters
- **Unavailable characters:** " & ; : / \* < > ? \ |
- **Default:** None (blank)

**Note**

- When “Name w/time&date” is selected, the file name will be [“Entered file name” + “Time and date (year/ month/ day/ hour/ minute/ second)” + “Serial number (starting from 00)”] + “s” during summer time.

**[Transmission interval]**

Select the interval for the FTP periodic image transmission from the following.

1s/ 2s/ 3s/ 4s/ 5s/ 6s/ 10s/ 15s/ 20s/ 30s/ 1min/ 2min/ 3min/ 4min/ 5min/ 6min/ 10min/ 15min/ 20min/ 30min/ 1h/ 1.5h/ 2h/ 3h/ 4h/ 6h/ 12h/ 24h

- **Default:** 1s

**[Image capture size]**

Select the image capture size of images to be transmitted from the following.

JPEG(1)/JPEG(2)

- **Default:** JPEG(2)

## SFTP server

### Note

- When FTP is selected for [Transmission protocol], the SFTP server setting cannot be set.

### [SFTP server address]

Enter the IP address or the host name of the SFTP server.

- **Available number of characters:** 1 - 128 characters
- **Unavailable characters:** Alphanumeric characters, the colon (:), the period (.), the underscore (\_), and the hyphen (-).

### IMPORTANT

- When entering the host name for “SFTP server address”, it is necessary to configure the DNS settings on the [Network] tab of the “Network” page. (→“3.11.1 Configure the network settings [Network]”)

### [Port number]

Enter a control port number to be used for the FTP server.

- **Available port number:** 1 - 65535
- **Default:** 22

The following port numbers are unavailable since they are already in use.

20, 21, 23, 25, 42, 53, 67, 68, 69, 80, 110, 123, 161, 162, 443, 995, 1883, 8883, 10669, 10670

### [Host key hash]

Enter the hash value of the public key of the SFTP server.

- **Available number of characters:** 43 - 44 characters
- **Available characters:** Alphanumeric characters, +, /, =

### [User name]

Enter the user name (login name) to access the FTP server.

- **Available number of characters:** 1 - 32 characters
- **Unavailable characters:** " & ; \

### [Password]

Enter the password to access the FTP server.

- **Available number of characters:** 0 - 32 characters
- **Unavailable characters:** " &

## FTP server setting

### Note

- When SFTP is selected for [Transmission protocol], the FTP server setting cannot be set.

### [FTP server address]

Enter the IP address or the host name of the FTP server.

- **Available number of characters:** 1 - 128 characters
- **Available characters:** Alphanumeric characters, the colon (:), the period (.), the underscore (\_), and the hyphen (-).

### IMPORTANT

- When entering the host name for “FTP server address”, it is necessary to configure the DNS settings on the [Network] tab of the “Network” page. (→“3.11.1 Configure the network settings [Network]”)

**[User name]**

Enter the user name (login name) to access the FTP server.

- **Available number of characters:** 1 - 32 characters
- **Unavailable characters:** " & ; ; \

**[Password]**

Enter the password to access the FTP server.

- **Available number of characters:** 0 - 32 characters
- **Unavailable characters:** " &

**[Control port]**

Enter a control port number to be used for the FTP server.

- **Available port number:** 1-65535
- **Default:** 21

The following port numbers are unavailable since they are already in use.

20, 22, 23, 25, 42, 53, 67, 68, 69, 80, 110, 123, 161, 162, 443, 995, 1883, 8883, 10669, 10670

**[FTP mode]**

Select "Passive" or "Active" for the FTP mode.

Normally, select "Passive". When it is impossible to connect after select "Passive", try to connect after selecting "Active".

- **Passive:** "Passive" is selected for the FTP mode.
- **Active:** "Active" is selected for the FTP mode.
- **Default:** Passive

### 3.11.2.3 Configure the settings relating to the NTP server

The settings relating to the NTP server such as the NTP server address, port number, etc. can be configured on this page.

**IMPORTANT**

- Use an NTP server when the more accurate time & date setting is required for the system operation.

**[Time adjustment]**

Select the time adjustment method from the following. Time adjusted by the selected method will be used as the standard time of the camera.

- **Manual:** Time set on the [Basic] tab on the "Basic" page will be used as the standard time of the camera.
- **Synchronization with NTP server:** Time automatically adjusted by synchronizing with the NTP server will be used as the standard time of the camera.
- **Default:** Manual

**[NTP server address setting]**

When "Synchronization with NTP server" is selected for "Time adjustment", select the method of how to obtain the NTP server address from the following.

- **Auto:** Obtains the NTP server address from the DHCP server.
- **Manual:** The NTP server address will be entered manually on "NTP server address".
- **Default:** Manual

#### **IMPORTANT**

- When obtaining the NTP server address from the DHCP server, it is necessary to select “DHCP”, “Auto(AutoIP)”, or “Auto(Advanced)” for “Network Settings” on the [Network] tab of the “Network” page. (→“3.11.1 Configure the network settings [Network]”)

#### **[NTP server address]**

When “Manual” is selected for “NTP server address setting”, enter the IP address or the host name of the NTP server.

- **Available number of characters:** 1 - 128 characters
- **Available characters:** Alphanumeric characters, the colon (:), the period (.), the underscore (\_), and the hyphen (-).
- **Default:** None (blank)

#### **IMPORTANT**

- When entering the host name for “NTP server address”, it is necessary to configure the DNS settings on the [Network] tab of the “Network” page. (→“3.11.1 Configure the network settings [Network]”)

#### **[NTP port]**

Enter a port number of the NTP server.

- **Available port number:** 1 - 65535
- **Default:** 123

The following port numbers are unavailable since they are already in use.

20, 21, 22, 23, 25, 42, 53, 67, 68, 69, 80, 110, 161, 162, 443, 995, 1883, 8883, 10669, 10670

#### **[Time adjustment interval]**

Select an interval (1 - 24 hours: in 1 hour intervals) of synchronization with the NTP server.

- **Default:** 1h

#### **[NTP test]**

After selecting “Synchronization with NTP server” for “Time adjustment” and configuring the NTP server information, click the [Execute] button. Communication with the NTP server will be established, the time will be synchronized and the NTP operation check will become available.

#### **Note**

- When the NTP test successfully completed, “The NTP time correction completed successfully.” will be displayed.
- When the NTP test failed, “The NTP time correction failed.” will be displayed.
- When “Manual” is set for “Time adjustment”, the [Execute] button of “NTP test” will be displayed in grey.
- When “Synchronization with NTP server” is set for “Time adjustment” and no address is set for “NTP server address”, the [Execute] button of “NTP test” will be greyed out.

### 3.11.2.4 Configure the UPnP settings

This camera support UPnP (Universal Plug and Play). By using the UPnP function, it becomes possible to configure the following automatically.

- Configuration of the port forwarding function of the router (However, a router supporting UPnP is required.) This configuration is useful when accessing the camera via the Internet, or from a mobile terminal or tablet device.
- Automatic refreshment of the shortcut to the camera that is created on the [Network] folder of the PC even when the IP address of the camera changes.



**[Auto port forwarding]**

Select “On” or “Off” to determine whether or not to use the port forwarding function of the router.

To use the port forwarding function, the router in use must support UPnP and the UPnP must be enabled.

- **Default:** Off

**Note**

- Due to port forwarding, the port number may sometimes be changed. When the number is changed, it is necessary to change the port numbers registered in the PC and recorders, etc.
- The UPnP function is available when the camera is connected to the IPv4 network. IPv6 is not supported.
- To check if auto port forwarding is properly configured, click the [Status] tab on the “Maintenance” page, and check that the “Enable” is displayed for “Status” of “UPnP”. (→“3.13.3 Check the status [Status]”)
 

When “Enable” is not displayed, refer to “Cannot access the camera via the Internet.” in the “4.2 Troubleshooting” section.
- When the live page or the setting page is not correctly displayed such as when replacing the router in use, set “UPnP (Auto port forwarding)” to “Off” once and then set it to “On” again.

**[Camera short cut]**

Select whether or not to create the shortcut to the camera on the [Network] folder of the PC. When creating the shortcut, select “On”.

To use the shortcut function to the camera, enable the UPnP function on the PC in advance.

- **Default:** Off

**Note**

- To display the shortcut to the camera on the [Network] folder of the PC, it is necessary to add the Windows component. Refer to the following to enable the UPnP function.  
 [Start] → [Settings] → [NETWORK & INTERNET] → [Ethernet] → [Network and Sharing Center] → select [Turn on network discovery] of [Network discovery] of [Change advanced sharing settings] → click [Save changes] → Complete

### 3.11.2.5 Configure the HTTPS settings

It is possible to enhance the network security by encrypting the access to cameras using the HTTPS function. Refer to “3.11.3 How to configure HTTPS settings” for how to configure the HTTPS settings.

**[HTTPS - Connection]**

Select the protocol used to connect the camera.

- **HTTP:** HTTP and HTTPS connections are available.
- **HTTPS:** Only the HTTPS connection is available.
- **Default:** HTTP

Select a TLS to be used when “HTTPS” is selected.

- **TLS1.1:** Select “On” or “Off” to determine whether to enable or disable.
- **TLS1.2, TLS1.3:** Always “On”, “Off” cannot be set.
- **Default:** TLS1.1: Off, TLS1.2: On, TLS1.3: On

**Note**

- To change to an HTTPS connection when HTTP is selected, perform HTTPS connection settings first. The HTTPS connection will be available even if the setting is changed to HTTP afterwards.

**[HTTPS - Select certificate]**

Select the certificate to be used with HTTPS.

### 3 Detailed settings

---

- **Pre-installed:** Select a pre-installed certificate.
- **CA:** Select a CA certificate. Only displayed when the CA Certificate is installed.
- **Default:** Pre-installed

#### [HTTPS - HTTPS port]

Designate the HTTPS port number to be used.

- **Available port number:** 1 - 65535
- **Default:** 443

The following port numbers are unavailable since they are already in use.

20, 21, 22, 23, 25, 42, 53, 67, 68, 69, 80, 110, 123, 161, 162, 554, 995, 1883, 8883, 10669, 10670, 59000-61000

#### [Pre-installed certificate - Download root certificate]

Click the [Execute] button to download the root certificate for the pre-installed certificate. By installing the root certificate to your PC, you can get signature verification for the pre-installed certificate.

#### [CA Certificate - CRT key generate]

CRT key (SSL encryption key) used for the HTTPS protocol is generated. To generate the CRT key, click the [Execute] button to display "CRT key generate" dialog box.

#### [CA Certificate - Generate Certificate Signing Request]

When using the security certificate issued by CA (Certificate Authority) as the security certificate used for the HTTPS protocol, the CSR (Certificate Signing Request) will be generated.

To generate the CSR, click the [Execute] button to display the "CA Certificate - Generate Certificate Signing Request" dialog window.

#### [CA Certificate - CA Certificate install]

Installs the CA certificate (security certificate) issued by CA (Certificate Authority) and displays the information of the installed CA certificate (security certificate).

To install the CA certificate (security certificate), click the [Choose File] button to display the [Open] dialog box, and select the file of the CA certificate (security certificate) issued by CA, and click the [Execute] button.

If the CA certificate (security certificate) is already installed, the file name of the installed CA certificate (security certificate) will be displayed.

#### [CA Certificate - Information]

Displays the information of the CA certificate (security certificate).

When the [Confirm] button is clicked, the registered information of the installed CA certificate (security certificate) will be displayed in the "CA Certificate - Confirm" dialog box. If the CA certificate (security certificate) is not installed, the content of the generated CSR file will be displayed.

When the [Delete] button is clicked, the installed CA certificate (security certificate) will be deleted.

#### **IMPORTANT**

- Before deleting the valid CA certificate (security certificate), confirm that there is a backup file of the CA certificate (security certificate) on the PC or another media. The backup file of the CA certificate (security certificate) will be required when installing the CA certificate (security certificate) again.

#### **Note**

- After changing the connection setting, access the camera again by after waiting a while according to the changed setting ("http://IP address of the camera" or "https://IP address of the camera").
- When the camera is accessed using the HTTPS protocol, the refresh interval and frame rate of images may be lower.
- When the camera is accessed using the HTTPS protocol, it may take time to display images.
- When the camera is accessed using the HTTPS protocol, the images may be distorted or audio may be interrupted.

- The maximum number of concurrent access user varies depending on the maximum image size and transmission format.

### 3.11.2.6 Configure the settings relating to DDNS

To access this camera via the Internet, it is necessary to configure the settings for the DDNS function. Refer to “3.11.4 How to configure the settings relating to DDNS” for how to configure the settings relating to DDNS.

#### [Area]

Select the region where the camera is installed.

Japan/Global

#### Note

- If the camera is used in Japan, select “Japan”. If the camera is used outside of Japan, select “Global”. The “Viewnetcam.com” service that is displayed when “Global” is selected cannot be used in Japan.

#### [Service]

Select the DDNS service to determine whether or not to use DDNS.

- **Off:** Does not use the DDNS function.
- **Viewnetcam.com:** Uses the “Viewnetcam.com” service.
- **Dynamic DNS Update:** Uses Dynamic DNS Update (RFC2136 compliant) without the DHCP cooperation.
- **Dynamic DNS Update(DHCP):** Uses Dynamic DNS Update (RFC2136 compliant) with the DHCP cooperation.
- **Default:** Off

#### Note

- When using Dynamic DNS Update (RFC2136 compliant), refer to the network administrator for whether or not to cooperate with the DHCP.

### 3.11.2.7 Configure the settings relating to SNMP

The settings relating to SNMP can be configured on this page. It is possible to check the status of the camera by connecting to the SNMP manager. When using the SNMP function, contact the network administrator.

#### SNMP agent setting

##### [SNMP version]

Select the SNMP version to be used.

- **SNMPv1/v2:** SNMPv1/v2 is activated.
- **SNMPv3:** SNMPv3 is activated.
- **SNMPv1/v2/v3:** SNMPv1/v2/v3 is activated.
- **Default:** SNMPv1/v2

##### [SNMPv1/v2] - [Community]

Enter the community name to be monitored.

- **Available number of characters:** 0 - 32 characters
- **Default:** None (blank)

#### **IMPORTANT**

- When using the SNMP function with SNMPv1/v2, it is necessary to enter a community name. When no community name is entered, the SNMP function will not work. Do not set a community name that can easily be guessed. (Example: public)

#### **[SNMPv1/v2] - [Manager address]**

Enter the IP address of the SNMP manager from which requests are to be permitted when the SNMP version is v1 or v2. When left blank, requests from all IP addresses will be permitted.

- **Available number of characters:** 1 - 128 characters
- **Available characters:** Alphanumeric characters, the colon (:), the period (.), the underscore (\_), the hyphen (-) and the slash (/).
- **Default:** None (blank)

#### **Note**

- When "IP address/subnet mask" is entered, it is possible to restrict IP address of SNMP manager from which request is permitted by subnet. For example, when "192.168.0.1/24" is entered, all requests from the SMNP managers in the range from "192.168.0.1" to "192.168.0.254" will be permitted.

#### **[SNMPv3] - [User name]**

Set the SNMPv3 user name.

- **Available number of characters:** Empty field or 1 - 32 characters
- **Unavailable characters:** " & ; \

#### **[SNMPv3] - [Authentication]**

Select the SNMPv3 authentication method from MD5 or SHA1.

- **Default:** MD5

#### **[SNMPv3] - [Encryption method]**

Select the SNMPv3 encryption method from DES or AES.

- **Default:** DES

#### **[SNMPv3] - [Password]**

Set the SNMPv3 password.

- **Available number of characters:**
  - If the authentication method is MD5: Empty field or 8-16 characters
  - If the authentication method is SHA1: Empty field or 8-20 characters
- **Unavailable characters:** " &

#### **SNMPv2-MIB system setting**

##### **[System name]**

Enter a system name to be used to manage the camera with the SNMP function.

- **Available number of characters:** 0 - 32 characters
- **Default:** None (blank)

##### **[Location]**

Enter the name of the location where the camera is installed.

- **Available number of characters:** 0 - 32 characters
- **Default:** None (blank)

##### **[Contact]**

Enter the E-mail address or the phone number of the SNMP manager.

- **Available number of characters:** 0 - 255 characters

- **Default:** None (blank)

### [SNMP trap setting]

Set On/Off of the SNMP trap.

- **Default:** Off

### [Destination of Trap] - [Address]

Enter the destination address of the SNMP trap.

- **Available number of characters:** 1 - 128 characters
- **Available characters:** Alphanumeric characters, the colon (:), the period (.), the underscore (\_), and the hyphen (-).
- **Default:** None (blank)

### [Destination of Trap] - [Port number]

Enter the port number of the destination address of the SNMP trap.

- **Available port number:** 1 - 65535
  - **Default:** 162
- The following port numbers are unavailable since they are already in use.  
20, 21, 22, 23, 25, 42, 53, 67, 68, 69, 80, 110, 123, 161, 443, 554, 995, 1883, 8883, 10669, 10670, 59000 - 61000

### [SNMPv2c] - [Community]

Enter the community name of the destination address of the SNMP trap.

- **Available number of characters:** 0 - 32 characters
- **Unavailable characters:** 2-byte characters
- **Default:** None (blank)

## IMPORTANT

- When using the SNMP trap function, it is necessary to enter the community name. When no community name is entered, the SNMP trap function will not work.

## Trap setting

### [SNMP Generic trap] - [coldStart] - [On/Off]

When the check box is checked, a trap (SNMPv2-MIB::coldStart) will be sent.

- **Default:** Not checked (Off)

### [SNMP Generic trap] - [coldStart] - [Trap string]

When a camera startup trap is to be extended and sent, set the string of characters of the extended trap.

- **Available number of characters:** 0 - 20 characters
- **Available characters:** 0-9, A-Z, a-z and the following marks.  
! " # \$ % & ' ( ) \* + , - . / : ; = ?
- **Default:** cold start

### [SNMP Generic trap] - [linkUP] - [On/Off]

When the check box is checked, a trap (SNMPv2-MIB::linkup) will be sent at the time when the camera is linked up.

- **Default:** Not checked (Off)

### [SNMP Generic trap] - [linkUP] - [Trap string]

When a camera linkup trap is to be extended and sent, set the string of characters of the extended trap.

- **Available number of characters:** 0 - 20 characters

### 3 Detailed settings

---

- **Available characters:** 0-9, A-Z, a-z and the following marks.  
!"#\$%&'()\*+,-./:;=?
- **Default:** linkup

#### [SNMP Generic trap] - [authenticationFailure] - [On/Off]

When the check box is checked, a trap (SNMPv2-MIB::coldStart) will be sent at the time when an SNMP authentication error occurs.

- **Default:** Not checked (Off)

#### [SNMP Generic trap] - [authenticationFailure] - [Trap string]

When a SNMP authentication error occurrence trap is to be extended and sent, set the string of characters.

- **Available number of characters:** 0 - 20 characters
- **Available characters:** 0-9, A-Z, a-z and the following marks.  
!"#\$%&'()\*+,-./:;=?
- **Default:** auth error

#### [Alarm] - [Terminal 1] - [On/Off]

When the check box is checked, a trap will be sent at the time when an alarm occurs in terminal 1.

- **Default:** Not checked (Off)

#### [Alarm] - [Terminal 1] - [Trap string]

Set the string of characters to be used for the trap of [Terminal 1].

- **Available number of characters:** 0 - 20 characters
- **Available characters:** 0-9, A-Z, a-z and the following marks.  
!"#\$%&'()\*+,-./:;=?
- **Default:** terminal alarm 1

#### [Alarm] - [Terminal 2] - [On/Off]

When the check box is checked, a trap will be sent at the time when an alarm occurs in terminal 2.

- **Default:** Not checked (Off)

#### [Alarm] - [Terminal 2] - [Trap string]

Set the string of characters to be used for the trap of [Terminal 2].

- **Available number of characters:** 0 - 20 characters
- **Available characters:** 0-9, A-Z, a-z and the following marks.  
!"#\$%&'()\*+,-./:;=?
- **Default:** terminal alarm 2

#### [Alarm] - [Terminal 3] - [On/Off]

When the check box is checked, a trap will be sent at the time when an alarm occurs in terminal 3.

- **Default:** Not checked (Off)

#### [Alarm] - [Terminal 3] - [Trap string]

Set the string of characters to be used for the trap of [Terminal 3].

- **Available number of characters:** 0 - 20 characters
- **Available characters:** 0-9, A-Z, a-z and the following marks.  
!"#\$%&'()\*+,-./:;=?
- **Default:** terminal alarm 3

#### [Alarm] - [VMD] - [On/Off]

When the check box is checked, a trap will be sent at the time when a video motion detection is activated.

- **Default:** Not checked (Off)

**[Alarm] - [VMD] - [Trap string]**

Set the string of characters to be used for the trap of [VMD].

- **Available number of characters:** 0 - 20 characters
- **Available characters:** 0-9, A-Z, a-z and the following marks.  
!"#\$%&'()\*+,-./:;=?
- **Default:** VMD alarm

**[Alarm] - [Auto track] - [On/Off]** **S613xx** **S653xx**

When the check box is checked, a trap will be sent at the time when an auto track is activated.

- **Default:** Not checked (Off)

**[Alarm] - [Auto track] - [Trap string]** **S613xx** **S653xx**

Set the string of characters to be used for the trap of [Auto track].

- **Available number of characters:** 0 - 20 characters
- **Available characters:** 0-9, A-Z, a-z and the following marks.  
!"#\$%&'()\*+,-./:;=?
- **Default:** auto track alarm

**[Alarm] - [Audio detection] - [On/Off]**

When the check box is checked, a trap will be sent at the time when an audio detection alarm occurs.

- **Default:** Not checked (Off)

**[Alarm] - [Audio detection] - [Trap string]**

Set the string of characters to be used for the trap of [Audio detection].

- **Available number of characters:** 0 - 20 characters
- **Available characters:** 0-9, A-Z, a-z and the following marks.  
!"#\$%&'()\*+,-./:;=?
- **Default:** audio

**[Alarm] - [Command alarm] - [On/Off]**

When the check box is checked, a trap will be sent at the time when a command alarm occurs.

- **Default:** Not checked (Off)

**[Alarm] - [Command alarm] - [Trap string]**

Set the string of characters to be used for the trap of [Command alarm].

- **Available number of characters:** 0 - 20 characters
- **Available characters:** 0-9, A-Z, a-z and the following marks.  
!"#\$%&'()\*+,-./:;=?
- **Default:** cmd

**[SD memory card] - [Diag.] - [On/Off]**

When the check box is checked, a trap will be sent in the following cases.

- When a notification of the remaining capacity of SD memory card has been provided
- When the SD memory card has become full
- When the SD memory card cannot be recognized
- **Default:** Not checked (Off)

**[SD memory card] - [Diag.] - [Trap string]**

Set the string of characters to be used for the trap of [Diag.].

- **Available number of characters:** 0 - 20 characters
- **Available characters:** 0-9, A-Z, a-z and the following marks.  
!"#\$%&'()\*+,-./:;=?

- **Default:** sd alarm

## 3.11.2.8 Configure the QoS settings

The settings relating to the Diffserv function and shaping of stream are configured in this section.

### Diffserv

The Diffserv function can be used to set the priority of image/audio data sent from routers. The priority set to this function must match the DSCP value configured to the router. When using the Diffserv function, contact the network administrator.

#### [Image DSCP(0-63)]

Enter the packet priority for video data.

- **Available values:** 0 - 63
- **Default:** 0

#### [Audio DSCP(0-63)]

Enter the packet priority for audio transmission/reception.

- **Available values:** 0 - 63
- **Default:** 0

#### [TCP alarm notification DSCP(0-63)]

Enter the packet priority for TCP alarm notification.

- **Available values:** 0 - 63
- **Default:** 0

### Shaping of stream

#### [Shaping of stream]

Select On/Off to determine whether or not to control the H.265 (or H.264) image data so that it does not burst. It is effective in situations such as when a network device loses video data from the camera, but the video display may be delayed.

- **Off:** Disables the shaping of stream function.
- **On:** Enables the shaping of stream function.
- **Default:** Off

#### Note

- If you are concerned about delays of the video display, select Off.

## 3.11.2.9 Configure the SRTP settings

The settings relating to the SRTP function are configured in this section.

#### [SRTP]

Select "On" or "Off" to determine whether or not to use the SRTP function.

- **On:** Use the SRTP function
- **Off:** Not use the SRTP function
- **Default:** Off



**Note**

- RTP distribution is available even when SRTP is set to “On”.
- Information on clients that can connect with SRTP is available on our technical information website <Control No.: C0318>.

**3.11.2.10 Configure the MQTT settings**

The settings relating to MQTT (Message Queueing Telemetry Transport) can be configured on this page.

The screenshot shows the 'Advanced' settings page for MQTT. At the top, there are navigation tabs for 'Network' and 'Advanced'. Below the tabs, there are links for various protocols: SMTP(E-mail), FTP/SETP, NTP, UPnP, HTTPS, DDNS, SNMP, QoS, SRTP, MQTT, and LLDP. The 'MQTT settings' section has a radio button to toggle 'On' or 'Off'. The 'Server' section includes fields for Address, Port number (with a default of 1883 and a note '(1-65535)'), Protocol, User name, and Password. The 'Root CA certificate' section has an 'Installation' button with a warning 'ファイルを選択 選択されていません' and an 'Execute' button. Below that, there is an 'Information' section with 'Invalid' status and 'Confirm' and 'Delete' buttons. The 'Server certificate verification' section has radio buttons for 'Enable' and 'Disable', with a note: 'When the server certificate verification is enabled, it is necessary to install a root CA certificate.' The 'Notification setting' section has a table with columns for 'Enable/Disable' and 'Notification string'. The 'Alarm' section has a table with columns for 'Enable/Disable', 'Topic', 'Payload', 'QoS', and 'Retain'. The table includes rows for Terminal 1, Terminal 2, Terminal 3, VMD, Auto track, Audio detection, and Command alarm. A 'Set' button is at the bottom.

**[MQTT settings]**

Set On/Off whether to enable/disable the MQTT function.

When set to “On”, or it is “On” when the camera starts up, it will connect to the set server.

When the set alarm occurs, the settings will be notified to the server.

- **On:** The MQTT function is enabled.
- **Off:** Does not use the MQTT function.
- **Default:** Off

## Server

### [Address]

Enter the IP address or host name of the MQTT server to be notified when an alarm occurs.

- **Available number of characters:** 1 - 128 characters
- **Available characters:** Alphanumeric characters, the colon (:), the period (.), the underscore (\_), and the hyphen (-).
- **Default:** None (blank)

### [NTP port]

Enter a port number of the MQTT server.

- **Available port number:** 1 - 65535
- **Default:** 8883

### **IMPORTANT**

- The following port numbers are unavailable since they are already in use.  
20, 21, 22, 23, 25, 42, 53, 67, 68, 69, 80, 110, 123, 161, 162, 443, 554, 995, 10669, 10670

### [Protocol]

Select the protocol to use when connecting to an MQTT server from MQTT over SSL/MQTT over TCP.

- **MQTT over SSL:** The communication with the MQTT server will be encrypted using SSL.
- **MQTT over TCP:** The communication with the MQTT server will not be encrypted.
- **Default:** MQTT over SSL

### [User name]

Enter the user name (login name) to access the MQTT server.

- **Available number of characters:** 0 - 32 characters
- **Unavailable characters:** " & ; ; \

### [Password]

Enter the password to access the MQTT server.

- **Available number of characters:** 0 - 32 characters
- **Unavailable characters:** " &

## Root CA certificate

### [Install]

Install the root CA certificate issued by the certification authority.

In the [Open] dialog box that appears when you click the [Choose File] button, select the root CA certificate file issued by the certification authority, and then click the [Execute] button to install the root CA certificate.

The data format of the root CA certificate is PEM format or DER format.

### [Information]

The root CA certificate information is displayed.

**Invalid:** The root CA certificate is not installed.

**Root CA certificate host name:** Indicates that the certificate is installed.

When the [Confirm] button is clicked, the details of CA certificate will be displayed.

When the [Delete] button is clicked, the installed CA certificate will be deleted.

### [Server certificate verification]

When [Protocol] is set to "MQTT over SSL" and [Server certificate verification] is set to "Enable", the server certificate is verified using the root CA certificate registered during the SSL connection.

- **Default:** Enable

#### Note

- When [Server certificate verification] is set to “Enable”, install the root CA certificate.

## Notification setting

### [Alarm]

Check the alarm events to be notified to the MQTT server.

**Terminal 1:** Notifies the MQTT server when an alarm occurs at terminal 1.

**Terminal 2:** Notifies the MQTT server when an alarm occurs at terminal 2.

**Terminal 3:** Notifies the MQTT server when an alarm occurs at terminal 3.

**VMD:** Notifies the MQTT server when motion detection occurs.

**Auto track** **S613xx** **S653xx**: A notification will be transmitted to the MQTT server when an auto track alarm occurs.

**Audio detection:** Notifies the MQTT server when audio detection occurs.

**Command alarm:** Notifies the MQTT server when a command alarm is entered.

### [Topic]

Set the MQTT topic name to be sent. Topics have a hierarchical structure separated by “/”.

- **Available number of characters:** 1 - 128 characters
- **Available characters:** Alphanumeric characters, 1-byte symbols
- **Unavailable characters:** “\”
- **Default:**
  - Terminal 1:** i-PRO/NetworkCamera/Alarm/Terminal/1
  - Terminal 2:** i-PRO/NetworkCamera/Alarm/Terminal/2
  - Terminal 3:** i-PRO/NetworkCamera/Alarm/Terminal/2
  - VMD:** i-PRO/NetworkCamera/Alarm/1/VideoMotionDetection
  - Auto track** **S613xx** **S653xx**: i-PRO/NetworkCamera/Alarm/AutoTrack
  - Audio detection:** i-PRO/NetworkCamera/Alarm/AudioDetection
  - Command alarm** i-PRO/NetworkCamera/Alarm/Command

### [Payload]

Set the MQTT message payload.

- **Available number of characters:** 1 - 128 characters
- **Available characters:** Alphanumeric characters, 1-byte symbols
- **Unavailable characters:** “\”
- **Default:**
  - Terminal 1:** terminal alarm 1
  - Terminal 2:** terminal alarm 2
  - Terminal 3:** terminal alarm 3
  - VMD:** VMD alarm
  - Auto track** **S613xx** **S653xx**: autoTrack
  - Audio detection:** audio
  - Command alarm:** cmd

### [QoS]

Select the QoS level from 0, 1, 2. The communication quality improves in the order of 0<1<2.

- **0:** The message is delivered at most once with QoS0. There is no guarantee that the message will reach the server.
- **1:** The message is delivered at least once with QoS1. The message is guaranteed to reach the destination, but may be duplicated.

### 3 Detailed settings

- **2:** The message is delivered exactly once with QoS2. It guarantees that the message arrives just once.
- **Default:** 1

#### [Retain]

Check this box if you want the MQTT server to save the last notified message.

- **Default:** Unchecked

### 3.11.2.11 Configure the LLDP settings

The settings relating to LLDP (Link Layer Discovery Protocol) can be configured on this page. Interoperability can be achieved by sending and receiving camera’s device information to and from LLDP-compatible devices.

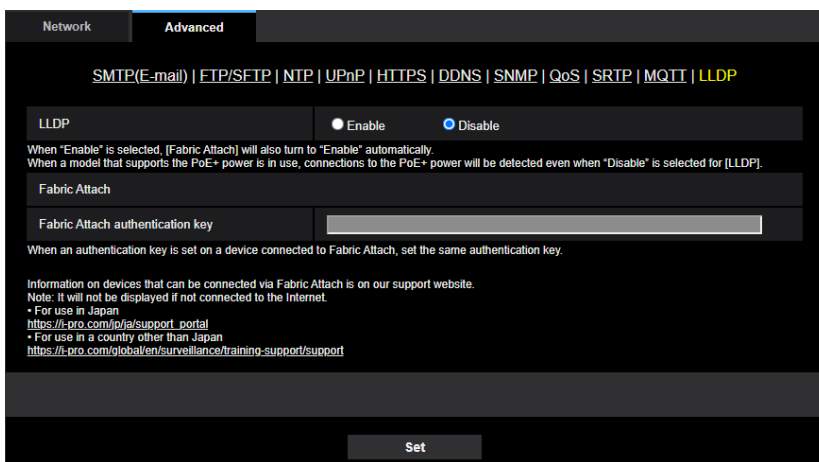

#### [LLDP]

Select “Enable” or “Disable” to determine whether to enable the LLDP function and Fabric Attach.

- **Enable:** The LLDP function and Fabric Attach are enabled.
- **Disable:** Does not use the LLDP function and Fabric Attach.
- **Default:** Disable

When set to “Enable”, LLDP including TLVs with the checks in the table below will be sent.

End Of LLDPPDU TLV	Chassis ID TLV	Port ID TLV	Time To Live TLV	Port Description TLV	System Name TLV	System Description TLV	System Capability TLV	Management Address TLV	IEEE802.3 Power via MDI TLV	Fabric Attach Element TLV
✓	✓	✓	✓	✓	✓	✓	✓	✓	✓	✓

\* Models that support PoE+ power supply will send LLDP including TLVs with the checks in the table below for PoE+ power supply even if set to “Disable”.

End Of LLDPDU TLV	Chassis ID TLV	Port ID TLV	Time To Live TLV	Port Description TLV	System Name TLV	System Description TLV	System Capability TLV	Management Address TLV	IEEE802.3 Power via MDI TLV	Fabric Attach Element TLV
✓	✓	✓	✓						✓	

## Fabric Attach

### [Fabric Attach authentication key]

Enter the key to be used for Fabric Attach authentication. Note that this is valid only when “LLDP” is “Enable”.

- **Available number of characters:** 0 - 32 characters (If Fabric attach authentication is not performed, leave it blank.)
- **Available characters:** Alphanumeric characters
- **Default:** None (blank)

### Note

- Click the [Set] button to restart the camera. After restarting, the product cannot be operated for about 2 minutes, just like when the power is turned on.
- For information about devices that can be connected using Fabric Attach, refer to our technical information website.

### 3.11.3 How to configure HTTPS settings

The settings relating to the HTTPS protocol that can enhance the network security by encrypting the access to cameras on this page.

HTTPS settings can be configured by either using the certificate pre-installed to the camera, or using a CA certificate that you obtained by yourself from the CA (CA: Certification Authority). For how to configure the HTTPS (pre-installed certificate), refer to the video clip <Control No.: P0002> on the support video page on our support website. Refer to <Control No.: P0003> for how to configure the HTTPS settings (CA certificate).

### 3.11.4 How to configure the settings relating to DDNS

When activating the DDNS function using the camera, either of the following DDNS services is available.

- “Viewnetcam.com” service
- Dynamic DNS Update (RFC2136 compliant)

#### **IMPORTANT**

- Before using the DDNS service, it is necessary to perform the port forwarding setting for the router.
- **About Dynamic DNS Update (RFC2136 compliant)**  
Operation using DDNS services other than the “Viewnetcam.com” service is not guaranteed. We are not responsible for any troubles or accidents on the circumstances where the camera is used arising out of such services.  
Refer to the DDNS service providers for the selection and configuration of the DDNS services other than the “Viewnetcam.com” service.

#### **Note**

- “Viewnetcam.com” is a Dynamic DNS service designed for use with our network cameras. Refer to the “Viewnetcam.com” website for further information about the service.

### About DDNS services (IPv4/IPv6)

By using a DDNS service, it becomes possible to view camera images via the Internet.

The DDNS service associates dynamic global addresses and domain names.

It is possible to configure the settings for the “Viewnetcam.com” or Dynamic DNS Update (RFC2136 compliant). In most of the DNS services offered by providers, global addresses are not static but dynamic. Therefore, access to the camera via an old global address may be invalidated after a certain period of time. Either of the following services is required when accessing a camera whose global address is not static via the Internet.

- **DDNS service (such as “Viewnetcam.com”)**  
It is possible to access via a registered and static domain name (example: \*\*\*\*\*.viewnetcam.com) even after the global address is changed. Enrollment in a domain name service is required even when using the IPv6 connection.  
Refer to the “Viewnetcam.com” website for further information about the service.
- **Static IP address service (such as a service offered by a contracted provider)**  
In this service, global addresses are static (not changed).

### 3.11.4.1 Configuration of the DDNS service (Example of the “Viewnetcam.com” service)

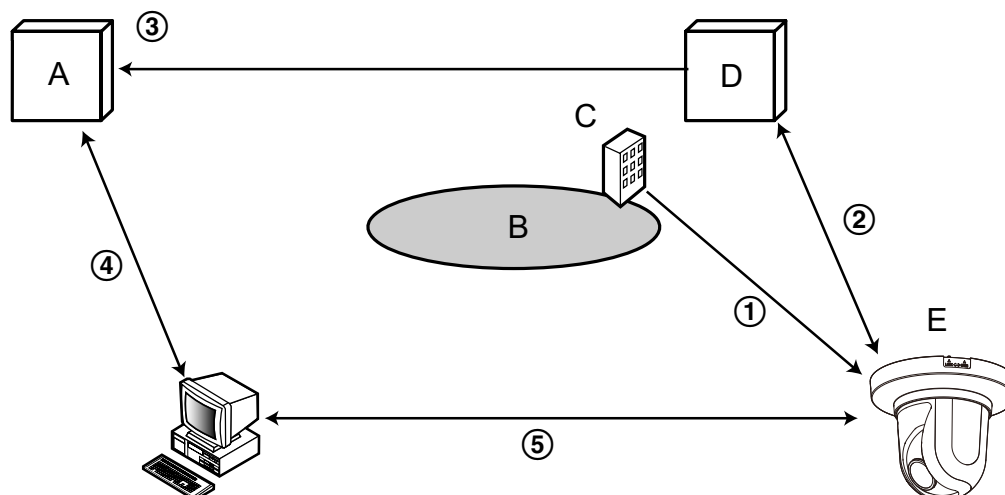

- A.** DNS server  
**B.** Internet  
**C.** Provider  
**D.** “Viewnetcam.com” service server  
**E.** Remote site

**① Global address is changed.**

The contracted provider allocates a global address to the router (or the camera). The global address is not static but dynamic.

**② “\*\*\*\*\*.viewnetcam.com” and the current global address is automatically registered.**

If you are enrolled in “Viewnetcam.com”, the unique “domain name” (example: \*\*\*\*\*.viewnetcam.com) will be allocated. The “Viewnetcam.com” service server automatically manages the domain name of camera and the global address of router (or camera) when a camera automatically notifies the service server of the global address.

**③ Current global address is automatically registered via “\*\*\*\*\*.viewnetcam.com”.**

The “Viewnetcam.com” service server registers the global address and the domain name of router (or camera) in the DNS server.

**④ Global address is obtained via the URL (domain name).**

By entering the URL (including the domain name) on the web browser when accessing the camera via the Internet, the DNS server identifies the registered global address of router (or camera).

**⑤ Access using the current global address**

The identified global address is used for accessing the router (or camera) to monitor images.

**Note**

- Refer to the contracted provider whether the current IP address is static or not.
- Depending on the provider, local addresses may be allocated. In this case, the DDNS service is unavailable. Refer to the contract provider for further information.

## When using the “Viewnetcam.com” service

Network	
Advanced	
SMTP(E-mail)   FTP/SETP   NTP   UPnP   HTTPS   DDNS   SNMP   QoS   SRTP   MQTT   LLDP	
DDNS	
Area	Global
Service	Viewnetcam.com
Personal(Camera) URL	
Your Account Link	
Access interval	1h
Global IP Address Notification Method	<input checked="" type="radio"/> Normal <input type="radio"/> Advanced
<input type="button" value="Set"/>	

### [Personal(Camera) URL]

The URL of the camera registered for “Viewnetcam.com”.

### [Your Account Link]

When the displayed URL is clicked, the registration window for the “Viewnetcam.com” service will be displayed in a newly opened window.

Register the information in the registration window to enroll in the “Viewnetcam.com” service.

### [Access interval]

Select the interval to access the “Viewnetcam.com” service server to check the IP address and the host name from the following.

10min/ 20min/ 30min/ 40min/ 50min/ 1h

- **Default:** 1h

### [Global IP Address Notification Method]

Typically [Global IP Address Notification Method] should be set to “Normal”.

If you cannot access the camera using the registered URL 30 minutes after registering with “Viewnetcam.com”, select “Advanced”.

In this case, UPnP (→“3.11.2.4 Configure the UPnP settings”) must be enabled for the camera and for the router.

- **Default:** Normal

## Procedure to register information for the “Viewnetcam.com” service

1. Select [Viewnetcam.com] for [Service] and click the [Set] button.  
→ A URL is displayed in [Your Account Link].  
If a URL is not displayed in [Your Account Link], confirm the camera's network settings and Internet connection, then click [Set] again.
2. Register the information for “Viewnetcam.com” by following the instructions of the wizard.  
→ The registration window for “Viewnetcam.com” will be displayed in a newly opened window.



When the registration window is not displayed, check that the PC is being connected to the Internet, and click the reload button of the browser.

DDNS	
Area	Global
Service	Viewnetcam.com
Personal(Camera) URL	
Your Account Link	http://*****
Access interval	1h
Global IP Address Notification Method	<input checked="" type="radio"/> Normal <input type="radio"/> Advanced

**Set**

- Register the information for “Viewnetcam.com” by following the instructions of the wizard.
  - When the message “The new camera is successfully registered to Viewnetcam.com” is displayed, close the registration window.
  - The URL set at the time of registration can be used for camera access. However, this URL is unavailable when accessing the camera from the PC connected to the same network (LAN).

DDNS	
Area	Global
Service	Viewnetcam.com
Personal(Camera) URL	**** *
Your Account Link	http://*****
Access interval	1h
Global IP Address Notification Method	<input checked="" type="radio"/> Normal <input type="radio"/> Advanced

**Set**

### Note

- When the registration for the “Viewnetcam.com” service is completed, the URL registered for “Personal(Camera) URL” is displayed. It may take up to about 30 minutes until the URL of the registered camera is validated.
- To cancel the enrollment in the “Viewnetcam.com” service, access the “Viewnetcam.com” website (<http://www.viewnetcam.com/>) later.
- When “Expired” is displayed in the URL of “Viewnetcam.com” in the viewnetcam settings page or the status page, restart the camera after registering the “Viewnetcam.com” service. After restarting the camera, check that the registered URL is displayed in the URL of “Viewnetcam.com” of [Status] - [Viewnetcam.com] on the “Maintenance” page.
- It is possible to check the information registered for the “Viewnetcam.com” service by accessing the URL displayed beside “Your Account Link”. When the URL is not displayed, check that the PC is being connected to the Internet, and click the [Set] button.

### 3 Detailed settings

---

- If access often fails due to the change in the global address of router, set a smaller value for “Access interval”.

## Checking the information registered for the “Viewnetcam.com” service

It is possible to check if the camera has been registered for the “Viewnetcam.com” service. (→“3.13.3 Check the status [Status]”)

### 3.11.4.2 When using “Dynamic DNS Update”

#### [Host name]

Enter the host name to be used for the Dynamic DNS Update service.

- **Available number of characters:** 3 - 250 characters  
Enter in the form of “(host name). (domain name)”.
- **Available characters:** Alphanumeric characters, the period (.), and the hyphen (-).
- **Default:** None (blank)

#### Note

- Refer to the network administrator for further information about the available host names.

#### [Access interval]

Select the interval to access the Dynamic DNS Update service server to check the IP address and the host name from the following.

10min/ 20min/ 30min/ 40min/ 50min/ 1h/ 6h/ 24h

- **Default:** 24h

### 3.11.4.3 When using “Dynamic DNS Update(DHCP)”

#### [Host name]

Enter the host name to be used for the Dynamic DNS Update service.



- **Available number of characters:** 3 - 250 characters  
Enter in the form of “(host name). (domain name)”.
- **Available characters:** Alphanumeric characters, the period (.), and the hyphen (-).
- **Default:** None (blank)

#### Note

- Refer to the network administrator for further information about the available host names.

## 3.12 Configure the settings relating to the schedules [Schedule]

On the “Schedule” page, it is possible to configure the settings relating to schedules as follows.

- Alarm permission (Terminal alarm 1, 2, 3)
- Alarm permission(Terminal alarm 1)
- Alarm permission(Terminal alarm 2)
- Alarm permission(Terminal alarm 3)
- VMD permission
- SCD permission
- Audio detection permission
- Access permission
- SD memory recording
- Scene file
- FTP/SFTP periodic image transmission
- E-mail permission
- Position refresh
- Preset position (1-256)
- Auto track permission  
- Auto pan
- Patrol
- Preset sequence
- Reboot (Schedule 8 only)

The “Schedule” page has only the [Schedule] tab.  
Up to 8 schedules can be set.

1. Select an action to be assigned to the schedule from “Schedule mode”.  
“Off” is selected at the default.
  - **Off:** No action will be taken for the respective schedule.
  - **Alarm permission (Terminal alarm 1, 2, 3):** Alarm input (terminal alarm) will be allowed during the period of the schedule.
  - **Alarm permission(Terminal alarm 1):** Terminal 1 alarm input will be allowed during the period of the schedule.
  - **Alarm permission(Terminal alarm 2):** Terminal 2 alarm input will be allowed during the period of the schedule.
  - **Alarm permission(Terminal alarm 3):** Terminal 3 alarm input will be allowed during the period of the schedule.
  - **VMD permission:** The video motion detection (VMD) function will be active during the period of the schedule.
  - **SCD permission:** The scene change detection (SCD) function will be active during the period of the schedule.
  - **Audio detection permission:** The audio detection function will be active during the period of the schedule.
  - **Access permission:** Users whose access level is set to “2. Camera control” and “3. Live only” on the [User auth.] tab (→“3.10.1 Configure the settings relating to the user authentication [User auth.]”) can access the camera only in the period of schedule.
  - **Recording to SD(Recording stream):** The SD recording will be performed at the designated time in the schedule. Further, the “Recording format” is enabled only when there is a stream.

### 3 Detailed settings

---

- **Image adjust 1: Scene 1:** Images are set to the image settings of “Scene file 1” at the designated time in the schedule. When the designated time for the schedule finishes, images are set to the image settings of “Scene file is not applied”.
- **Image adjust 2: Scene 2:** Images are set to the image settings of “Scene file 2” at the designated time in the schedule. When the designated time for the schedule finishes, images are set to the image settings of “Scene file is not applied”.
- **Image adjust 3: Scene 3:** Images are set to the image quality settings of “Scene file 3” at the designated time in the schedule. Once designated time in the schedule is over, the image quality setting is set to “Scene file is not applied”.
- **Image adjust 4: Scene 4:** Images are set to the image quality settings of “Scene file 4” at the designated time in the schedule. Once designated time in the schedule is over, the image quality setting is set to “Scene file is not applied”.
- **FTP/SFTP periodic image transmission:** FTP/SFTP periodic image transmission will be performed at the designated time in the schedule.
- **E-mail permission:** While the schedule is set, e-mail notification is sent when alarm is input.
- **Position refresh:** The camera position will be refreshed at the designated time in the schedule.
- **1-256:** The camera will move to the selected position from the preset position at the designated time in the schedule.
- **Auto track permission** **S613xx** **S653xx**: The auto track activation setting set on the [Auto track setting] tab will be permitted during the period of the schedule.
- **Auto pan:** The camera will start the auto-panning operation set on the [Position] tab at the designated time in the schedule.
- **Patrol 1:** The camera will start the patrol 1 operation set on the [Position] tab at the designated time in the schedule. This is enabled only when “Patrol 1” is set.
- **Patrol 2:** The camera will start the patrol 2 operation set on the [Position] tab at the designated time in the schedule. This is enabled only when “Patrol 2” is set.
- **Patrol 3:** The camera will start the patrol 3 operation set on the [Position] tab at the designated time in the schedule. This is enabled only when “Patrol 3” is set.
- **Patrol 4:** The camera will start the patrol 4 operation set on the [Position] tab at the designated time in the schedule. This is enabled only when “Patrol 4” is set.
- **Preset sequence 1:** The camera will start the preset sequence 1 operation set on the [Position] tab at the designated time in the schedule. This is enabled only when “Preset sequence 1” is set.
- **Preset sequence 2:** The camera will start the preset sequence 2 operation set on the [Position] tab at the designated time in the schedule. This is enabled only when “Preset sequence 2” is set.
- **Preset sequence 3:** The camera will start the preset sequence 3 operation set on the [Position] tab at the designated time in the schedule. This is enabled only when “Preset sequence 3” is set.

#### Note

- Select “On” for “User auth.” on the [User auth.] tab of “User mng.” page (→“3.10.1 Configure the settings relating to the user authentication [User auth.]”) and “Off” for “Host auth.” on the “Host auth.” page (→“3.10.2 Configure the settings relating to the host authentication [Host auth.]”) to validate “Access permission”.
  - When selecting “Recording to SD(Recording stream)”, select “Stream(1)”, “Stream(2)”, “Stream(3)”, or “Stream(4)” for “Recording format” on the [SD memory card] tab and select “Schedule” for “Save trigger”. (→[Save trigger])
2. Select days of a week by checking the respective checkboxes.
  3. From the pull-down menu, select the start time and the end time of the schedule.  
When not designating time, check the checkbox of “24h”.

#### Note

- When setting “Auto pan”, “Patrol” or “Preset sequence”, be sure that the operation time ranges of them are not overlapped.

4. Click the [Set] button after completing the settings.  
→ The result will be displayed at the bottom of the window.

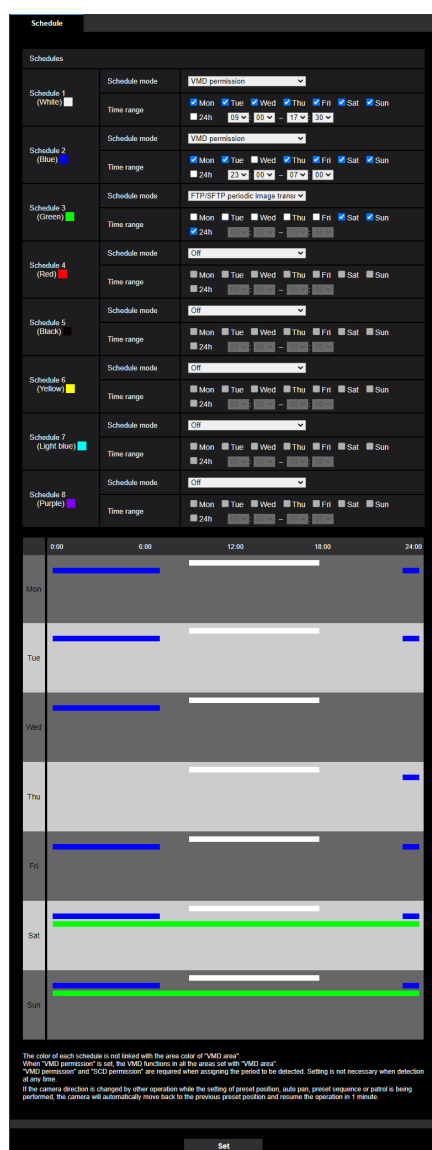

### Note

- The schedules displayed at the bottom of the window can be identified by colors assigned to each schedule.
- If the schedules for position refresh and image quality are set to the same times, the action for image quality will be performed after the action for position refresh is finished.
- When "Off" is set for the operation mode of schedule 1 through 8, constant operation of the following items will be allowed.
  - Alarm permission (Terminal alarm 1, 2, 3)
  - Alarm permission(Terminal alarm 1)
  - Alarm permission(Terminal alarm 2)
  - Alarm permission(Terminal alarm 3)
  - VMD permission
  - SCD permission

### 3 Detailed settings

- Audio detection permission
- Access permission
- E-mail permission

#### 3.12.1 How to set the schedules

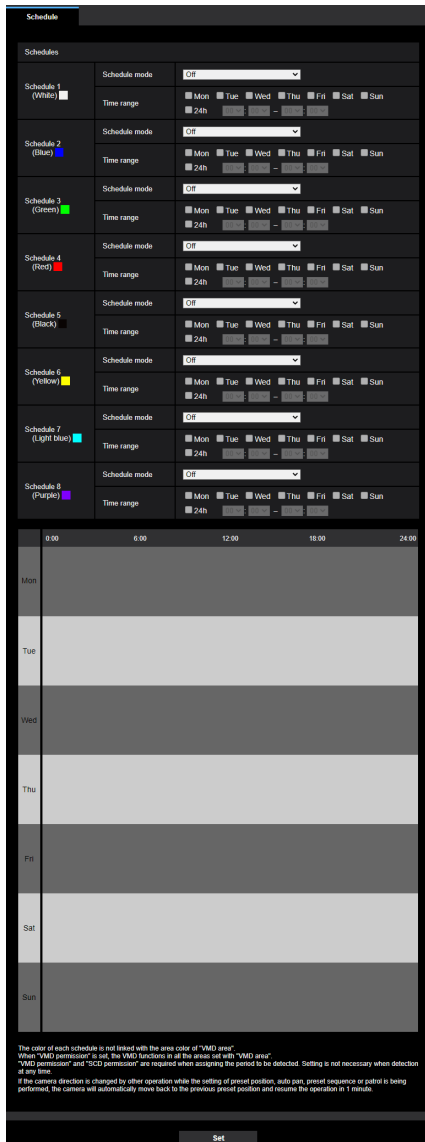

1. Check the check box of the desired day of the week of "FTP image transmission schedule".  
→ The selected day of the week will be validated for the schedule.
2. To designate time, select the desired "hour" and "minute" from the pull-down menu.  
When not designating time, check the checkbox of "24h".

3. Click the [Set] button after completing the settings.  
 → The result will be displayed at the bottom of the window.

The screenshot displays the 'Schedule' configuration interface. It features a list of eight schedules, each with a unique color and specific settings:

Schedule	Color	Schedule mode	Time range
Schedule 1	White	VMD permission	Mon 09:00 - Sun 17:30
Schedule 2	Blue	VMD permission	Mon 23:00 - Sun 09:00
Schedule 3	Green	DIS/STP period (image noise)	Mon 00:00 - Sun 00:00
Schedule 4	Red	Off	Mon 00:00 - Sun 00:00
Schedule 5	Black	Off	Mon 00:00 - Sun 00:00
Schedule 6	Yellow	Off	Mon 00:00 - Sun 00:00
Schedule 7	Light blue	Off	Mon 00:00 - Sun 00:00
Schedule 8	Purple	Off	Mon 00:00 - Sun 00:00

Below the schedule list is a Gantt chart showing the active periods for each schedule across the days of the week (Mon to Sun) from 0:00 to 24:00. The chart uses colored bars to represent the time ranges defined in the settings above.

The color of each schedule is not linked with the area color of "VMD area".  
 When "VMD permission" is set, the VMD functions in all the areas set with "VMD area".  
 "VMD permission" and "DIS/STP permission" are required when assigning the period to be detected. Setting is not necessary when detection of any time.  
 If the camera direction is changed by other operation while the setting of present position, auto pan, preset sequence or patrol is being performed, the camera will automatically move back to the previous present position and resume the operation in 1 minute.

At the bottom of the window, there is a 'Set' button.

## 3.12.2 How to delete the set schedule

1. Uncheck the check box of the set day of the week.
2. Click the [Set] button after completing the settings.  
→ The schedule of the selected day of the week is deleted.

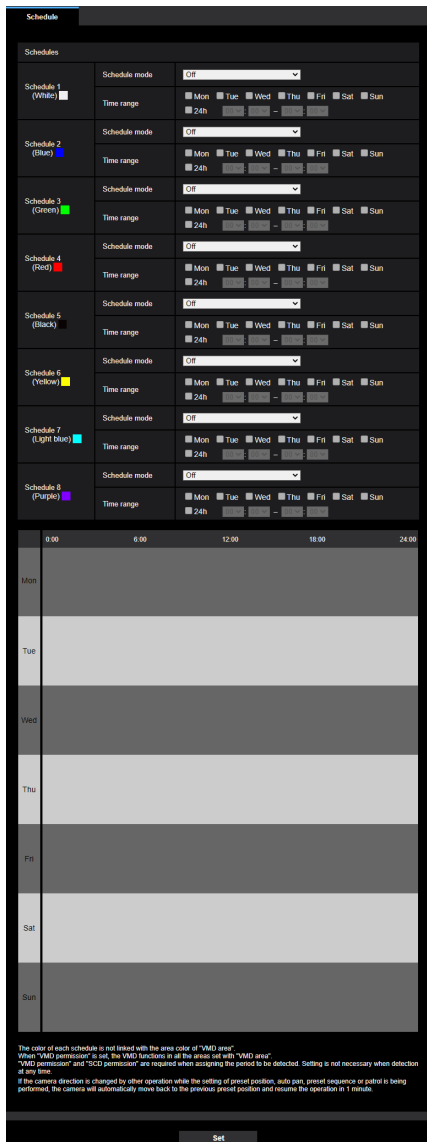



## 3.13 Maintenance of the camera [Maintenance]

System log check, firmware upgrade, status check and initialization of the setup menu can be performed on this page.

The “Maintenance” page has the [System log] tab, the [Upgrade] tab, [Status] tab, the [Default reset] tab, and the [Data] tab.

### 3.13.1 Check the system log [System log]

Click the [System log] tab of the “Maintenance” page. (→“3.2.1 How to display the setup menu”, “3.2.2 How to operate the setup menu”)

Up to 4,000 system logs can be saved on the SD memory card when the SD memory card is inserted after selecting “Use” for “SD memory card” on the [SD memory card] tab. (→“3.5.2 Configure the settings relating to the SD memory card [SD memory card]”)

When “Not use” is selected for “SD memory card”, up to 100 system logs can be saved on the built-in memory of the camera.

When the saved system logs have reached the maximum number, the newer logs will overwrite the older system logs. In this case, the oldest log is the first to be overwritten.

The system logs will be displayed in group of 100 logs each, and the logs will be saved even when the power of the camera is turned off.

#### [<< Latest 100]

When clicking “<< Latest 100”, the latest 100 system logs will be displayed.

#### [Next 100 >>]

When clicking “Next 100 >>”, the next 100 system logs will be displayed.

#### [Number of pages display]

The currently opened page will be displayed in the “page/total page” format.

#### [<< Previous 100]

When clicking “<< Previous 100”, the previous 100 system logs will be displayed.

#### [No.]

The serial number of the system log will be displayed.

#### [Time & date]

Time and date at the error occurrence will be displayed.

#### Note

- When “Off” is selected for “Time display format” on the [Basic] tab (→“3.5.1 Configure the basic settings [Basic]”), time & date of logs will be displayed in 24-hour format.

#### [Description]

The descriptions about the system log will be displayed. Refer to “4.1 About the displayed system log” for further information about the system logs.

## 3.13.2 Upgrade the firmware [Upgrade]

Click the [Upgrade] tab of the “Maintenance” page. (→“3.2.1 How to display the setup menu”, “3.2.2 How to operate the setup menu”)

The current firmware can be checked and upgraded to the latest version on this page. Contact the dealer for further information about the firmware upgrade.

### [Model no.], [MAC address], [Serial no.], [Firmware version], [IP address(IPv6)], [Time past from the date of manufacture]

Information of each item will be displayed.

1. Contact the dealer and download the latest firmware onto a PC.

#### **IMPORTANT**

- A blank (space) cannot be used for the name of the directory where the downloaded firmware to be saved.

2. Click the [Choose File] button and designate the downloaded firmware.

#### **Note**

- The latest firmware upgrade is posted on our website.  
<https://i-pro.com/global/en/surveillance/training-support/support>

3. Click the radio button respective to the desired option to determine whether or not to initialize the settings after completing the firmware upgrade.

**Default:** Do not reset the settings to the default after the upgrade.

#### **Note**

- Note that the settings cannot be restored after an initialization is operated.

4. Click the [Execute] button.

→ The confirmation window will be displayed.

#### **IMPORTANT**

- After upgrading, make sure to check the version on this page.
- After completing the upgrade, delete temporary internet files. (→“4.2 Troubleshooting”)
- Upgrade the firmware using a PC in the same subnet as the unit.
- Follow the instructions from the dealer when upgrading the firmware.
- When upgrading the application software, use the designated file (extension: img) for the firmware upgrade.  
The name of the firmware to be used for the upgrade should be “model name (Use small letters. “WV-” is not required.)\_xxxxx.img”.  
\* (“xxxxx” indicates the version of the firmware.)
- Do not turn off the power of the camera during the upgrade process.
- Do not perform any operation during upgrading and wait until it completes.
- The following network settings will not be reset when upgrading the firmware after selecting “Reset the settings to the default after completing the upgrade. (Except the network settings)”.  
Primary server address and secondary server address DNS settings for IPv4, primary DNS server address and secondary DNS server address settings for IPv6, On/Off for DHCP, IP address, subnet mask, default gateway, HTTP port, HTTPS port, connection protocol (HTTP/HTTPS), CRT key, CA certificate, UPnP setting, line speed, bandwidth control (bit rate), time & date, IEEE802.1X setting, Extension software **S613xx** **S653xx**, Extension software setting **S613xx** **S653xx**
- The viewer software used on each PC should be licensed individually. Refer to your dealer for the software licensing.

### 3.13.3 Check the status [Status]

Click the [Status] tab of the "Maintenance" page. (→"3.2.1 How to display the setup menu", "3.2.2 How to operate the setup menu")

The status of this camera can be checked on this page.

#### Image transmission

When the [Confirm] button is clicked, the image transmission log will be displayed on the other window. Up to 4000 image transmission logs can be saved on the SD memory card when the SD memory card is inserted after selecting "Use" for "SD memory card" on the [SD memory card] tab (→"3.5.2 Configure the settings relating to the SD memory card [SD memory card]")

When no SD memory card is inserted or "Not use" is selected for "SD memory card", up to 200 image transmission logs can be saved on the built-in memory of the camera.

When the saved image transmission logs have reached the maximum number, the newest log will overwrite the oldest log.

The image transmission logs will be displayed in group of 100 logs each and the logs will be saved even when the power of the camera is turned off.

#### [<< Latest 100]

When clicking "<< Latest 100", the latest 100 image transmission logs will be displayed.

#### [Next 100 >>]

When clicking "Next 100 >>", the next 100 image transmission logs of the currently displayed image transmission log list will be displayed.

#### [Number of pages display]

The currently opened page will be displayed in the "page/total page" format.

#### [<< Previous 100]

When clicking "<< Previous 100", the previous 100 image transmission logs of the currently displayed image transmission log list will be displayed.

#### [No.]

The serial number of the image transmission log will be displayed.

#### [Time & date]

Time and date of the image transmission log will be displayed.

#### [Stream type]

The stream type (stream (\*), JPEG (\*), playback of video on the SD memory card (\*)) of the image transmission log will be displayed.

The asterisk (\*) indicates a number.

#### [Connected user]

The user name of the user who transmitted the image will be displayed.

#### Note

- When "Off" is selected for [User auth.], "-" will be displayed.

#### [IP address]

The IP address that transmitted images will be displayed.

#### **[Event]**

Start request/stop request for image transmission and start error (access concentration) will be displayed.

#### **Note**

- In the following cases, log of stop request may not be filed.
  - When the setting relating to stream such as the image capture mode, stream and image capture size
  - When the screen is shifted from “Live” page to a setup menu page
  - When the “Live” page is closed
  - When the network is disconnected

## Viewnetcam.com

#### **[Server]**

The URL of the “Viewnetcam.com” service server will be displayed.

#### **[Status]**

The registration status for the “Viewnetcam.com” will be displayed.

#### **[Personal(Camera) URL]**

The URL of the camera registered for “Viewnetcam.com” will be displayed.

## UPnP

#### **[Port number(HTTP), Port number(HTTPS)]**

The port number that is set for UPnP port forwarding will be displayed.

#### **[Status]**

The port forwarding status will be displayed.

#### **[Router global address]**

The global address of router will be displayed.

## Self check

The self check result of the hardware will be displayed.

#### **Note**

- Refer to our technical information website <Control No.: C0111> for further information about the contents of the displayed statuses (relating to the “Viewnetcam.com” service, the UPnP function, or the self check).

## Hardware information

#### **[Number of times of pan/tilt operation]**

Number of times of the pan/tilt operations and the last replacement time will be displayed.

When the [Execute] button of [Reset at the time of replacement] is clicked, the number of times of operation will be reset to 0 and the last replacement time will be updated.

#### **[Number of times of zoom/focus operation]**

Number of times of the zoom/focus operations and the last replacement time will be displayed.

When the [Execute] button of [Reset at the time of replacement] is clicked, the number of times of operation will be reset to 0 and the last replacement time will be updated.

### **[Status]**

Number of times of start-up operation, operating time, temperature sensor information and others will be displayed.

### **Note**

- Refer to our website <Control No.: C0111> for further information about the contents of the displayed statuses (relating to the “Viewnetcam.com” service, the UPnP function, or the self check).

## **SD memory card**

### **[Model no.]**

Displays the model number of the SD memory card.

If model number information could not be obtained, “Read error” is displayed. If the SD memory card is not used, “Not use” is displayed. In other cases “Unknown” is displayed.

### **[Serial no.]**

Displays the serial number of the SD memory card.

If the serial number information could not be obtained, “Unknown” is displayed.

### **[Remaining capacity]**

Displays the remaining capacity and total capacity of the SD memory card.

This is the same information that is displayed in [Remaining capacity] of the SD memory card information on the [SD memory card] tab of the “Basic” page.

### **[Total use time]**

Displays the length of time that SD memory card has been inserted into and used with the camera.

If the length of time that the SD memory card has been used for cannot be obtained, “Unknown” is displayed. “Total use time” is updated once per hour.

### **[Number of overwrite times]**

Displays the number of overwrite times as calculated from the total capacity of the SD memory card, the number of times the camera has written files to the SD memory card, and the file sizes.

If the number of overwrite times cannot be calculated, “Unknown” is displayed.

### **Note**

- Because the overwrite time values are just estimates calculated by the camera, they may differ to the actual number of overwrite times.
- The above information will not be displayed if “SD memory card password lock” is set and the password is not matched.

## **[No.] / [Time & date] / [Description] of the log**

Displays the log related to the SD memory card.

### 3 Detailed settings

---

Category	Indication	Description
SD memory card	<SD> Format	Successfully formatted the SD memory card.
	<SD> Format error	Error occurred when formatting the SD memory card.
	<SD> Detection error	The SD memory card could not be correctly recognized.
	<SD> Write error	An error occurred when writing to the SD memory card.
	<SD> Read error	An error occurred when reading from the SD memory card.
	<SD> Delete error	An error occurred when deleting data from the SD memory card.
	<SD> File system error	An error occurred in File system of the SD memory card.
	<SD> Undefined error	An error other than the ones above has occurred for the SD memory card.
	<SD> An abnormality occurs in continuity of the SD memory recording. Check the recording bit rate setting of the SD memory recording.	An error occurred when writing to the SD memory card.
	<SD> An error occurs in the SD memory card. Check the status of the SD memory card.	The SD memory card write process still generates data loss. Make sure that the SD memory card is properly recognized. If the card is not recognized, reboot the unit, or remove and reinsert the SD memory card to check.

#### **IMPORTANT**

- In order to be able to correctly use this function, format the SD memory card with the camera before using it.
- When using SD memory cards that have been used on other devices such as PCs, the correct information may not be able to be displayed.
- Up to 30 SD memory card logs can be saved to the built-in memory of the camera. When the saved system logs have reached the maximum number, the newer logs will overwrite the older system logs.

#### **Note**

- Refer to our support website for further information about the contents of the displayed statuses (relating to the "Viewnetcam.com" service, the UPnP function, or the self check).

### 3.13.4 Reset the settings/Reboot the camera [Default reset]

Click the [Default reset] tab of the “Maintenance” page. (→“3.2.1 How to display the setup menu”, “3.2.2 How to operate the setup menu”)

The setting data of the camera can be initialized and reboot of the camera can be performed on this page.

#### [Reset to the default (Except the network settings)]

Click the [Execute] button to reset the settings to the default. Note that the network settings will not be reset. It is impossible to operate the camera for about 3 minutes after the initialization.

#### [Load the default HTML files (setup menu).]

Click the [Execute] button to reset the HTML files to the default.

It is impossible to operate the camera for about 3 minutes after the initialization.

#### [Reset to the default and load the default HTML files.]

Click the [Execute] button to reset the settings of the camera and the HTML files to the default. Note that the network settings will not be reset.

It is impossible to operate the camera for about 3 minutes after the initialization.

#### [Reboot]

Click the [Execute] button to reboot the camera. It is impossible to operate the camera for about 2 minutes after rebooting the camera.

#### [Position refresh]

The camera position will be reset to the original position.

When the camera has moved from the correct home/preset position during normal use, or when it has been inadvertently moved while turning on the power of the camera, use this function to correct the camera position.

It is impossible to operate the camera during the position refresh process for about 2 minutes.

#### **IMPORTANT**

- The direction of the camera may be accidentally changed when the camera is installed. When registering presets after the installation, we recommend performing position refresh.

#### **Note**

- Refer to the “Basic Information” for more information about initializing the network settings. (→“3.11.1 Configure the network settings [Network]”)
- If “Diag.” of the alarm or e-mail notification function is selected, a notification of error will be sent to “Destination E-mail address” or to “Destination of notification” when an error such as no SD memory card insertion after the reboot occurs. (→“3.11.2.1 Configure the settings related to sending E-mails”, “3.9.10 Configuration of the settings relating to alarm notification [Notification]”)

### 3.13.5 Settings data/backing up or restoring logs [Data]

Click the [Data] tab of the “Maintenance” page. (→“3.2.1 How to display the setup menu”, “3.2.2 How to operate the setup menu”)

The settings related to backing up or restoring settings data, and saving logs can be configured in this section.

#### Backup

##### [Setup data]

Click the [Execute] button to backup the setup data of the camera to a PC.

##### [Scene file]

Click the [Execute] button to backup the scene files of the camera to a PC.

##### [Logs]

Click the [Execute] button to backup the log data of the camera to a PC.

#### **IMPORTANT**

- When backing up settings or logs, creating the backup files takes time.
- When the backup operation takes 10 minutes or more, a communication timeout may occur. In this case all of the backup data may not be obtained. Therefore, we recommend completing backup operations within 10 minutes. It is also possible to check whether or not the correct data was obtained by restoring the obtained data (excluding log data).

#### Restore

##### [Setup data]

Press the [Choose File] button and select the setup data files to restore.

Click the radio button respective to the desired option to determine whether or not to also restore network related setting contents.

Click the [Execute] button to start restoring. Do not perform operations until the restoration is complete. (The camera will be rebooted when the restoration is complete.)

Make sure to set the file name of setup data files used when restoring to “model name.dat”. (The model name must be written in lower case letters and “WV-” is not needed.)

**Default:** Restore all settings except the network settings.

#### **IMPORTANT**

- When 5 minutes or more is required to restore setup data files, there is a possibility that the restore will fail because of reasons such as transmission disconnections. In this case, restore setup data files again.

#### **Note**

- Restore operations for setup data are not applied to HTTPS related settings.
- Restore operations for setup data are not applied to extension software. **S613xx** **S653xx**

##### [Scene file]

Press the [Choose File] button and select the scene files to restore.

Click the [Execute] button to start restoring. Do not perform operations until the restoration is complete.

Make sure to set the file name of scene file data used when restoring to “model name.txt”. (The model name must be written in lower case letters and “WV-” is not needed.)



## 3.14 Display our support website [Support]

Methods for accessing our support website are explained on the “Support” page.

To access our support website from a web browser, click the link for the support page.

When “Click here for OSS information.” is clicked, the license of the OSS in use will be displayed.

## 4 Others

### 4.1 About the displayed system log

#### Error indications relating to SMTP

Category	Indication	Description
POP3 server error	Authentication error.	<ul style="list-style-type: none"> <li>Entered user name or password may be incorrect. Check if the E-mail settings are configured correctly.</li> </ul>
	Failed to find the POP3 server.	<ul style="list-style-type: none"> <li>The IP address of the server may be incorrect. Check if the IP address of the server is configured correctly.</li> <li>The POP3 server may be down. Ask the network administrator.</li> </ul>
SMTP server error	Authentication error.	<ul style="list-style-type: none"> <li>Entered user name or password may be incorrect. Check if the E-mail settings are configured correctly.</li> </ul>
	Failed to resolve the E-mail server address from DNS.	<ul style="list-style-type: none"> <li>The designated IP address of the DNS may be incorrect. Check if the DNS settings are configured correctly.</li> <li>The DNS server may be down. Ask the network administrator.</li> </ul>
	Failed to find the SMTP server.	<ul style="list-style-type: none"> <li>The IP address of the server may be incorrect. Check if the IP address of the server is configured correctly.</li> <li>The SMTP server may be down. Ask the network administrator.</li> </ul>
Internal error	Undefined error.	<ul style="list-style-type: none"> <li>An error occurred in the E-mail function. Check if the E-mail settings are configured correctly.</li> </ul>

#### Error indications relating to “Viewnetcam.com”

Category	Indication	Description
Access test error	Access test failed	<ul style="list-style-type: none"> <li>Port forwarding may not be configured for the router. Refer to the manuals provided with the router in use to enable the UPnP setting.</li> </ul>
Viewnetcam.com server error	Failed to resolve the Viewnetcam.com server address from DNS.	<ul style="list-style-type: none"> <li>The designated IP address of the DNS may be incorrect. Check if the DNS settings are configured correctly.</li> <li>The DNS server may be down. Ask the network administrator.</li> </ul>

Category	Indication	Description
Connection error	No response from the Viewnetcam.com server.	<ul style="list-style-type: none"> <li>The “Viewnetcam.com” server may be down. Ask the network administrator.</li> </ul>
	File transfer error.	
Internal error	Undefined error.	<ul style="list-style-type: none"> <li>An error relating to the “Viewnetcam.com” function occurred. Check if the “Viewnetcam.com” settings are configured correctly.</li> </ul>

### Error indications relating to Dynamic DNS Update

Category	Indication	Description
DDNS server error	Failed to resolve the DDNS server address from DNS.	<ul style="list-style-type: none"> <li>The designated IP address of the DNS may be incorrect. Check if the DNS settings are configured correctly.</li> <li>The DNS server may be down. Ask the network administrator.</li> </ul>
Connection error	No response from the DDNS server.	<ul style="list-style-type: none"> <li>The DDNS server may be down. Ask the network administrator.</li> </ul>
	Same host name has registered.	<ul style="list-style-type: none"> <li>The same host name has already been registered in the DDNS server. Check if the DDNS Update settings are configured correctly.</li> </ul>
Internal error	Undefined error.	<ul style="list-style-type: none"> <li>An error occurred in the DDNS function. Check if the DDNS Update settings are configured correctly.</li> </ul>

### Error indications relating to NTP

Category	Indication	Description
Connection error	No response from the NTP server.	<ul style="list-style-type: none"> <li>The IP address of the server may be incorrect. Check if the IP address of the server is configured correctly.</li> <li>The NTP server may be down. Ask the network administrator.</li> </ul>
Internal error	Undefined error.	<ul style="list-style-type: none"> <li>An error occurred in the NTP function. Check if the NTP settings are configured correctly.</li> </ul>
Synchronizing with NTP succeeded.	NTP update succeeded.	<ul style="list-style-type: none"> <li>Time correction succeeded.</li> </ul>

## Log indications relating to HTTPS

Category	Indication	Description
HTTPS	Certificate Signing Request - Generated	<ul style="list-style-type: none"> <li>Generation of the CSR (Certificate Signing Request) is complete.</li> </ul>
	CA Certificate - Installed	<ul style="list-style-type: none"> <li>Installation of the CA certificate is complete.</li> </ul>
	CA Certificate - Deleted	<ul style="list-style-type: none"> <li>Deletion of the CA certificate is complete.</li> </ul>
	Previous CRT key - Applied	<ul style="list-style-type: none"> <li>Previous CRT key is applied.</li> </ul>
	CRT key - Generated	<ul style="list-style-type: none"> <li>Generation of the CRT key is complete.</li> </ul>

## Error indications relating to FTP/SFTP

Category	Indication	Description
FTP server error	Failed to find the FTP server. Failed to resolve the FTP server address from DNS.	<ul style="list-style-type: none"> <li>The server may be down. Ask the network administrator.</li> <li>The IP address of the server may be incorrect. Check if the IP address of the server is configured correctly.</li> </ul>
Connection error	User name or password isn't correct.	<ul style="list-style-type: none"> <li>The server settings may be incorrect. Check if the settings are configured correctly.</li> <li>The settings relating to the indicated item may be incorrect. Check if the settings are configured correctly.</li> </ul>
	Failed to change the directory.	
	Host key verification error	
	Access not authorized	
	Failed to transmit the image	
	File transfer error.	
	Passive mode error.	
	Log out failed.	
Internal error	Undefined error.	<ul style="list-style-type: none"> <li>An error occurred in the FTP/SFTP function. Check if the FTP/SFTP settings are configured correctly.</li> </ul>

## Error indications relating to MQTT

Category	Indication	Description
MQTT	<MQTT> MQTT connection error	<ul style="list-style-type: none"> <li>When the connection to the server fails, certificate verification fails, or the server communication is disconnected (except for disconnections from the camera due to setting change)</li> </ul>
	<MQTT> MQTT notification error	<ul style="list-style-type: none"> <li>When publishing to the server fails</li> </ul>

## Log indications relating to login

Category	Indication	Description
Login	User name or IP address	<ul style="list-style-type: none"> <li>The login user name will be displayed when “On” is selected for “User auth.”.</li> <li>The IP address of the PC currently accessing to the camera will be displayed when “On” is selected for “Host auth.”.</li> </ul>

## Error indications relating to login error

Category	Indication	Description
Login failure	User name	<ul style="list-style-type: none"> <li>The user name that has failed in login will be displayed when “On” is selected for “User auth.”.</li> <li>If no user is registered, (Guest User) will be displayed.</li> <li>If “Login failure” log remains in the normal operation, it is not a malfunction of the camera.</li> <li>However, if many logs are output consecutively, there is a possibility of illegal access. Ask the network administrator.</li> </ul>

## Error indications relating to TCP alarm notification

Category	Indication	Description
TCP alarm notification error	Failed to find destination of notification.	<ul style="list-style-type: none"> <li>The IP address of the destination of notification may be incorrect. Check if the IP address of the destination of notification is configured correctly.</li> <li>The destination of notification may be down. Ask the network administrator.</li> </ul>
	Failed to resolve destination addr. from DNS.	<ul style="list-style-type: none"> <li>The DNS server settings may be incorrect. Check if the DNS settings are configured correctly.</li> <li>The DNS server may be down. Ask the network administrator.</li> </ul>

## Error indications relating to HTTP alarm notification

Category	Indication	Description
HTTP alarm notification error	Failed to find destination of notification.	<ul style="list-style-type: none"> <li>The IP address of the destination of notification may be incorrect. Check if the IP address of the destination of notification is configured correctly.</li> <li>The destination of notification may be down. Ask the network administrator.</li> </ul>
	Failed to resolve destination addr. from DNS.	<ul style="list-style-type: none"> <li>The DNS server settings may be incorrect. Check if the DNS settings are configured correctly.</li> <li>The DNS server may be down. Ask the network administrator.</li> </ul>
	Authentication error.	<ul style="list-style-type: none"> <li>Entered user name or password may be incorrect. Check if the HTTP alarm settings are configured correctly.</li> </ul>

## Error indications relating to SD memory card security settings

Category	Indication	Description
SD memory card	Certificate Signing Request - Generated	<ul style="list-style-type: none"> <li>Generation of the CSR (Certificate Signing Request) is complete.</li> </ul>
	CA Certificate - Installed	<ul style="list-style-type: none"> <li>Installation of the CA certificate is complete.</li> </ul>
	CA Certificate - Deleted	<ul style="list-style-type: none"> <li>Deletion of the CA certificate is complete.</li> </ul>
	Previous CRT key - Applied	<ul style="list-style-type: none"> <li>Previous CRT key is applied.</li> </ul>
	CRT key - Generated	<ul style="list-style-type: none"> <li>Generation of the CRT key is complete.</li> </ul>

## Log indications relating to Firmware Upgrade

Category	Indication	Description
Firmware Upgrade	Upgraded successfully	<ul style="list-style-type: none"> <li>Firmware Upgrade succeeded and the firmware versions(before/after) are logged.</li> </ul>

## Error indications relating to Firmware Upgrade

Category	Indication	Description
Firmware Upgrade	Upgrade failure (Time out: Shortage of communication bands)	<ul style="list-style-type: none"> <li>Failed to upgrade the firmware due to timeout caused by lack of communication bandwidth.) Check the communication environment and retry.</li> </ul>
	Upgrade failure (File error: Incorrect selection of firmware file)	<ul style="list-style-type: none"> <li>Failed to upgrade the firmware because an incorrect file was uploaded. Select the firmware of the camera and retry.</li> </ul>
	Upgrade failure (Communication error: File damage)	<ul style="list-style-type: none"> <li>Failed to upgrade the firmware because the file corrupted during the firmware file transfer. Check the communication environment and retry.</li> </ul>
	Upgrade failure (Other error)	<ul style="list-style-type: none"> <li>Undefined error occurred in the firmware upgrade process. Please wait for a while and retry.</li> </ul>

## Indications relating to power device connection

Category	Indication	Description
Power supply	<Power supply><PoE Injector/24VAC/PoE++> Operating on PoE Injector/24VAC/PoE++.	<ul style="list-style-type: none"> <li>Connection to 24 V AC power or PoE feeding device (injector) is detected.</li> </ul>
	<PoE+> Hardware is detected. Operating on PoE+	<ul style="list-style-type: none"> <li>Connection to the PoE+ power for hardware detection is detected.</li> </ul>
	<PoE+> Software detection on LLDP is detected. Operating on PoE+.	<ul style="list-style-type: none"> <li>Connection to the PoE+ power for software detection is detected.</li> </ul>
	<PoE+/PoE Injector/24VAC/PoE++> Detection error. Operating on PoE Class 0.	<ul style="list-style-type: none"> <li>Failed to detect a connection to 24 V AC power, PoE feeding device (injector) or the PoE+ power. Check whether the power supply device in use is compatible with PoE+ (IEEE802.3at compliant). Or use PoE feeding device (injector) or 24 V AC power supply.</li> </ul>

## Error indications relating to installation status

Category	Indication	Description
Installation	Installation status error	<ul style="list-style-type: none"> <li>Installation status error is detected. Check the installation status again, and turn on the power again.</li> </ul>

## 4.2 Troubleshooting

**Before asking for repairs, check the symptoms with the following table.**

Contact your dealer if a problem cannot be solved even after checking and trying the solution in the table or a problem is not described below.

Symptom	Cause/solution	Reference pages
Cannot access from the web browser.	<ul style="list-style-type: none"> <li>Is the LAN cable (category 5e or better) firmly connected to the network connector of the camera?</li> </ul>	Installation Guide
	<ul style="list-style-type: none"> <li>Is the link indicator (LINK) lit? When it is not lit, connection to a LAN may not be established or a network may not be working correctly. Check if the cables have any contact failure or if the wiring is correct or not.</li> </ul>	Installation Guide
	<ul style="list-style-type: none"> <li>Is the power of the camera on? Check if the power of the camera is turned on.</li> </ul>	Installation Guide
	<ul style="list-style-type: none"> <li>Are the set IP addresses valid?</li> </ul>	209
	<ul style="list-style-type: none"> <li>Are you accessing the wrong IP address? Check the connection as follows. With the Windows command prompt, &gt; ping "IP address of the camera". If there is reply from the camera, the connection is normal. If there is no reply, check the connection with the following methods using a computer connected to the same network as the camera. If the firewall settings on the PC are enabled, temporarily disable them before performing settings on the camera.               <ul style="list-style-type: none"> <li>Start the "IP Setting Software", confirm the camera's IP address, and then access that IP address.</li> <li>If the network settings (IP address, subnet mask, and default gateway) are incorrect, reboot the camera and change the network settings by using the "IP Setting Software" within 20 minutes after the restart.</li> <li>In networks that do not have a DHCP server, the IP address of the camera will be configured to "192.168.0.10" when the camera is rebooted by holding the INITIAL SET button on the camera. After the camera is initialized, access the camera and set the IP address again. (When the camera is initialized, all the settings of the camera previously configured on the setup menus will be initialized.)</li> </ul> </li> </ul>	-



Symptom	Cause/solution	Reference pages
Cannot access from the web browser.	<ul style="list-style-type: none"> <li>Is “554” selected for the HTTP port number? For the HTTP port number, select a port number other than the following port numbers used by the camera. The number used by the camera: 20, 21, 22, 23, 25, 42, 53, 67, 68, 69, 110, 123, 161, 162, 443, 554, 995, 1883, 8883, 10669, 10670, 59000 - 61000</li> </ul>	211
	<ul style="list-style-type: none"> <li>Is the same IP address provided to other devices? Are there contradictions between the address and the network subnet to be accessed? <b>When the camera and the PC are connected in the same subnet:</b> Are the IP addresses of the camera and the PC set in a common subnet? Or is “Use Proxy Server” for the settings of the PC? When accessing the camera in the same subnet, it is recommended to enter the address of the camera in the “Don’t Use Proxy For These Addresses” box. <b>When the camera and the PC are connected in the different subnet:</b> Is the IP address of the default gateway set for the camera correct?</li> </ul>	-
	<ul style="list-style-type: none"> <li>Is the name currently used to access the camera different from the name registered for the “Viewnetcam.com” service? Access the camera again with the registered name.</li> </ul>	240
	<ul style="list-style-type: none"> <li>Did you access “http://” while using the HTTPS function? To use the HTTPS function, access “https://”. It is also necessary to enter the port number. Refer to video clips &lt;Control No.: P0002&gt; and &lt;Control No.: P0003&gt; on the support video page on our support website.</li> </ul>	-
Cannot access the camera via the Internet.	<ul style="list-style-type: none"> <li>Are the network settings of the camera correct? Set the default gateway or DNS server address correctly. To use the DDNS service, check that the settings are correct.</li> <li>Is the setting for “Default gateway” on the “Network” page configured? Or is the setting correct? <b>When communicating using IPv4:</b> Configure the setting for “Default gateway” of “IPv4 network” on the [Network] tab of the setup menu.</li> </ul>	209

Symptom	Cause/solution	Reference pages
<p>Cannot access the camera via the Internet.</p>	<ul style="list-style-type: none"> <li>Is the setting of port forwarding configured for the router? To enable the access to the camera via the Internet, it is necessary to perform the port forwarding setting when the router in use does not support the UPnP function. Refer to the manuals provided with the router for further information.</li> <li>Is UPnP function of the router disabled? Refer to the manuals provided with the router in use to enable the UPnP function.</li> <li>Is packet filtering set for the router to forbid the access via the Internet? Configure the settings of the router in use to enable the access via the Internet. Refer to the manuals provided with the router for further information about the settings.</li> </ul>	<p>224</p>
	<ul style="list-style-type: none"> <li>Are you accessing the camera using the local address (the IP address used in a local network)? Check the IPv4 network setting, the IPv6 network and the DDNS setting and then use the global address (or the URL registered in the DDNS service) as the IP address of this camera to be used in the Internet and access using the port number of this camera.</li> </ul>	<p>209 210 238</p>
<p>Cannot access the camera via the URL of the “Viewnetcam.com” service.</p>	<ul style="list-style-type: none"> <li>Is the global address of camera (or router) notified to the “Viewnetcam.com” service server? Log into the “My Account” page of “Viewnetcam.com” website to check the information of the registered camera. If the global address is not displayed for the IP address, access the camera, and register the user information for the “Viewnetcam.com” service on the [Advanced] tab on the “Network” page of the setup menu. In addition, check the “Status” of “Viewnetcam.com” (on the [Status] tab) and the system log (on the [System log] tab) of the “Maintenance” page of the setup menu.</li> </ul>	<p>240 251</p>
<p>Authentication window is displayed repeatedly.</p>	<ul style="list-style-type: none"> <li>Is the user name and password changed? While accessing the camera, when changing the user name and password of another user logging into the camera on another web browser, the authentication window will be displayed each time the screen is changed or refreshed. Close the browser and access the camera again.</li> <li>Have you changed the [Authentication] setting? When the [Authentication] setting has been changed, close the web browser, and then access the camera again.</li> </ul>	<p>-</p>

Symptom	Cause/solution	Reference pages
It takes time to display the screen.	<ul style="list-style-type: none"> <li>Are you accessing the camera in the HTTPS mode? In this mode, the refresh interval becomes slower due to decode procession.</li> </ul>	-
	<ul style="list-style-type: none"> <li>Are you accessing another camera in the same local network via a proxy server? Configure the PC not to use a proxy server.</li> </ul>	-
	<ul style="list-style-type: none"> <li>Are two or more users browsing the camera images simultaneously? It may take time to display the screen or refresh interval may become slower when two or more users browse the camera images simultaneously.</li> </ul>	-
Cannot access the camera from a mobile terminal or a tablet device.	<p><b>For mobile terminals:</b></p> <ul style="list-style-type: none"> <li>Is the URL correct? Or is "/cam" missing at the end of the URL? Check if the URL is entered correctly. When accessing the camera from a mobile terminal, it is necessary to enter "/cam" at the end of the URL that is used for the camera access from a PC.</li> </ul> <p><b>For tablet devices:</b></p> <ul style="list-style-type: none"> <li>Is the URL correct? Check if the URL is entered correctly.</li> </ul>	25
	<ul style="list-style-type: none"> <li>Is the SSL encryption method different from that of the camera? Select "HTTP" (Do not select "HTTPS") for "HTTPS" - "Connection" on the "Network" page - the [Advanced] tab, and access the camera again.</li> </ul>	225
	<ul style="list-style-type: none"> <li>Did you access "http://" while using the HTTPS function? To use the HTTPS function, access "https://". It is also necessary to enter the port number. Refer to video clips &lt;Control No.: P0002&gt; and &lt;Control No.: P0003&gt; on the support video page on our support website.</li> </ul>	-
A cookie error was displayed when performing user registration for "Viewnetcam.com".	<ul style="list-style-type: none"> <li>Is the web browser configured to allow cookies? Configure the web browser to allow cookies.</li> </ul>	-
User registration for the "Viewnetcam.com" service fails.	<ul style="list-style-type: none"> <li>Is the registered E-mail address correct? When an E-mail with the "Viewnetcam.com" website link is not received, the registered E-mail address may be incorrect. Visit the "Viewnetcam.com" website to register the correct E-mail address.</li> </ul>	-

#### 4 Others

Symptom	Cause/solution	Reference pages
No image is displayed.	<ul style="list-style-type: none"> <li>Is the mobile terminal or tablet device in use support the 320×240 or 640×480 resolution? Or is the image data size too big to display images on the mobile terminal or tablet device? Refer to the manuals provided with the mobile terminal or tablet device in use for the restrictions of image data sizes.</li> </ul>	-
Images are displayed blurry.	<ul style="list-style-type: none"> <li>Is the focus adjusted correctly? Check if the focus is adjusted correctly.</li> </ul>	Installation Guide
Out-of-focus occurred immediately after turning on the power.	<ul style="list-style-type: none"> <li>After turning on the camera, temporarily out-of-focus occurred while focusing and zoom adjustment were being performed.</li> </ul>	-
The image is not being refreshed.	<ul style="list-style-type: none"> <li>Depending on the version of your browser, there might be difficulties refreshing the picture, etc.</li> </ul>	Basic Information
	<ul style="list-style-type: none"> <li>Depending on the traffic of the network or the concentration of access to the camera, there might be difficulties displaying the camera picture. Request the camera picture using the web browser such as by pressing the [F5] key, etc.</li> </ul>	-
No image is displayed (or too dark).	<ul style="list-style-type: none"> <li>Is the brightness setting set at an appropriate level? Click the [Normal] button of [Brightness].</li> </ul>	16
Images are displayed washed out.	<ul style="list-style-type: none"> <li>Is the brightness setting set at an appropriate level? Click the [Normal] button of [Brightness]. If you move the slider of [Adaptive black stretch] in the “-” direction, the dark parts of the image will become darker.</li> </ul>	16 132
Flicker appears on the screen.	<ul style="list-style-type: none"> <li>When flicker occurs frequently, select “Indoor scene” for “Light control mode”.</li> </ul>	124

Symptom	Cause/solution	Reference pages
Images cannot be saved on the SD memory card.	<ul style="list-style-type: none"> <li>Is the SD memory card inserted correctly? Check if the SD memory card is inserted correctly.</li> </ul>	Basic Information
Failed to write/read data on the SD memory card.	<ul style="list-style-type: none"> <li>Is the SD memory card formatted? Format the SD memory card.</li> </ul>	107
	<ul style="list-style-type: none"> <li>Is “-----MB/-----MB” displayed on “Remaining capacity” of the [SD memory card] tab? Format the SD memory card.</li> </ul>	107
	<ul style="list-style-type: none"> <li>Is “#####MB/#####MB” displayed on “Remaining capacity” of the [SD memory card] tab? Check the setting of “SD memory card password lock”.</li> </ul>	107 102
	<ul style="list-style-type: none"> <li>Is any recognition error received when the “Diag.” of “E-mail notification” or “TCP alarm notification” is used? Isn’t “&lt;SD&gt; Detection error” displayed in the log of “SD memory card” (under [Status] tab of the “Maintenance” page). Format the SD memory card.</li> </ul>	107 214 196
	<ul style="list-style-type: none"> <li>Isn’t the SD memory card out of order? There are limited times to overwrite on an SD memory card. When frequently overwritten, it may be at the end of product life. It is recommended to replace the SD memory card.</li> </ul>	-
Cannot transmit audio to the camera.	<ul style="list-style-type: none"> <li>Are the microphone and the speaker connected correctly and firmly? Confirm that they are connected correctly and firmly.</li> <li>Audio transmission is available only when connected with HTTPS.</li> </ul>	Installation Guide 20
Audio is not output from other products such as a network disk recorder or PC software package.	<ul style="list-style-type: none"> <li>Some of the products such as a network disk recorder or PC software package may not support “G.711”. Set “Audio input encoding format” of the products to “G.726 (32 kbps)” or “AAC-LC”.</li> </ul>	141
No image is displayed on the “Live” page.	<ul style="list-style-type: none"> <li>Press the [F5] key on the keyboard of the PC or click the [Live] button.</li> </ul>	12
Shortcut icon of the camera is not displayed on “Network” of the PC.	<ul style="list-style-type: none"> <li>Is the Windows component of UPnP added? Add the component to the PC in use.</li> </ul>	224

#### 4 Others

Symptom	Cause/solution	Reference pages
Images are not displayed or not refreshed smoothly.	<ul style="list-style-type: none"> <li>The firewall function of the anti-virus software may be filtering the port of the camera. Exclude the port number of the camera from the list of the port numbers to be filtered by the anti-virus software.</li> </ul>	-
No indicator lights.	<ul style="list-style-type: none"> <li>Is "Off" selected for "Indicator" on the "Basic" page? Select "On" for "Indicator".</li> </ul>	96
H.265 (or H.264) images are not smoothly displayed.	<ul style="list-style-type: none"> <li>It can be improved by performing the following.               <ul style="list-style-type: none"> <li>Check "System requirements for a PC" in the Basic Information.</li> </ul> </li> </ul>	Basic Information
When clicking the back button of the web browser, the screen is not displayed correctly.	<ul style="list-style-type: none"> <li>Press the [F5] key on the keyboard to refresh the display.</li> </ul>	-
Images are not fit in the frames.	<ul style="list-style-type: none"> <li>When "120 DPI" or higher is selected for "DPI setting", they may not be displayed correctly. Right-click on the desktop, click "Display settings", and then move the slider of "Change the size of text, apps, and other items" to "100% (Recommended)". Select "Landscape" of "Orientation".</li> </ul>	-
"Reached the concurrent access limit. Please try again later." is displayed on the "Live" page.	<ul style="list-style-type: none"> <li>Change the value set for "Max bit rate (per client)*" of the stream to a lower value.</li> <li>Change the setting of "Initial display stream" to a stream that a low value is set for "Max bit rate (per client)*".</li> </ul>	119 115

### 4.3 Directory structure of SD memory card

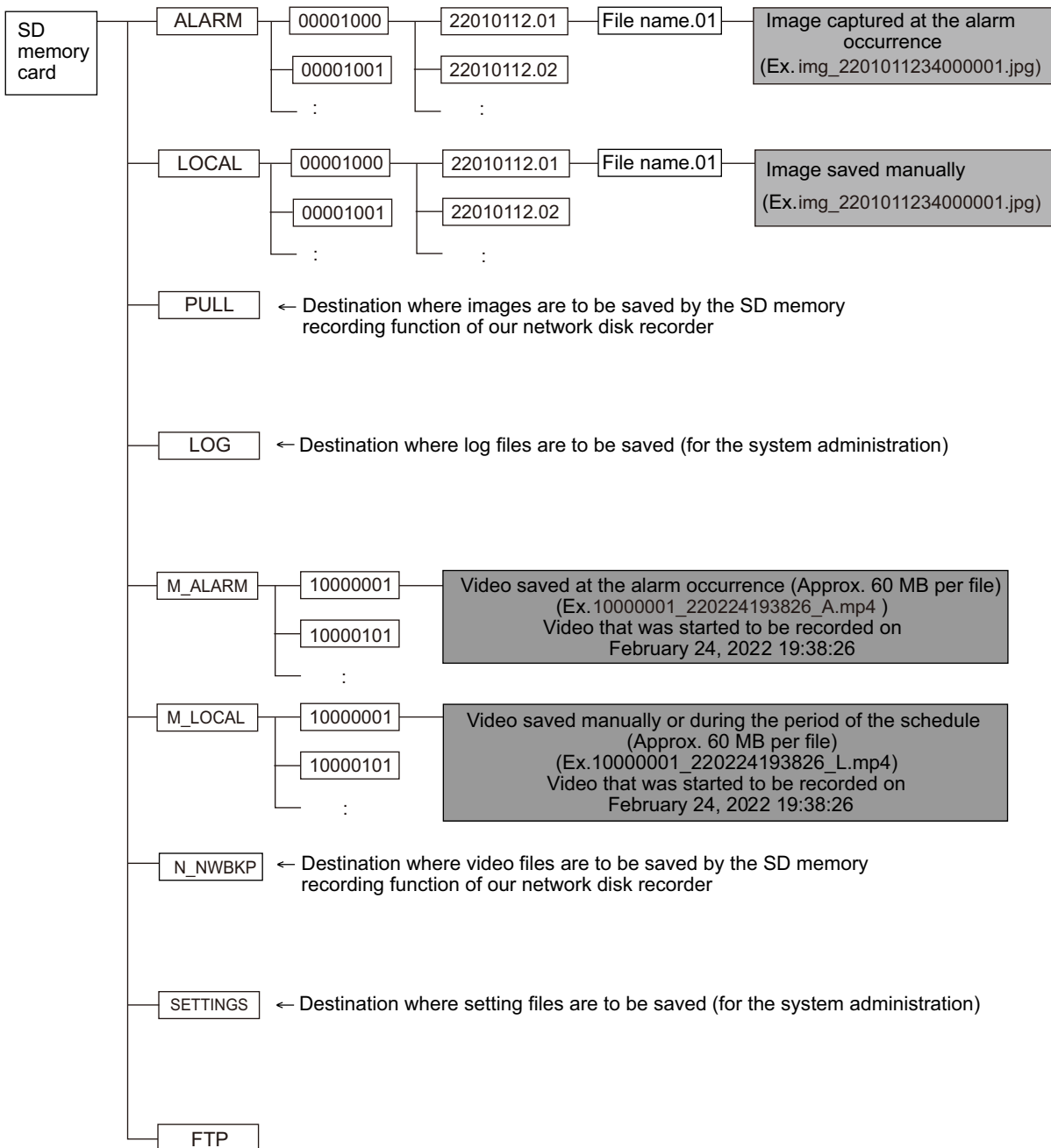

**i-PRO Co., Ltd.**

<https://www.i-pro.com/>

© i-PRO Co., Ltd. 2022

**PGQP3475XA** N0722-2122