

Panasonic®

Installation Guide

Network Disk Recorder

Model No. **WJ-NV300K**
WJ-NV300K/G

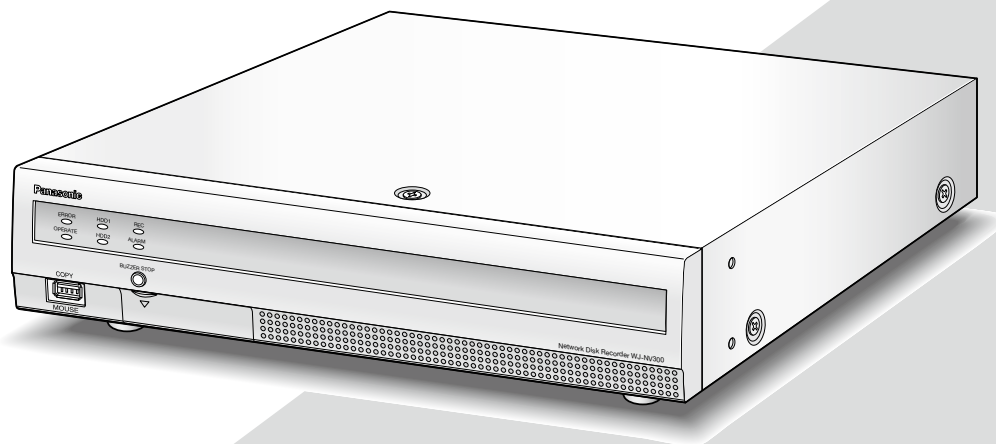

(This illustration represents WJ-NV300K.)



HDMI®
HIGH-DEFINITION MULTIMEDIA INTERFACE

Before attempting to connect or operate this product,
please read these instructions carefully and save this manual for future use.

The model number is abbreviated in some descriptions in this manual.

WARNING:

- This apparatus must be earthed.
- Apparatus shall be connected to a main socket outlet with a protective earthing connection.
- The mains plug or an appliance coupler shall remain readily operable.
- To prevent fire or electric shock hazard, do not expose this apparatus to rain or moisture.
- The apparatus should not be exposed to dripping or splashing and that no objects filled with liquids, such as vases, should be placed on the apparatus.
- All work related to the installation of this product should be made by qualified service personnel or system installers.
- For PERMANENTLY CONNECTED APPARATUS provided neither with an all-pole MAINS SWITCH nor an all-all pole circuit breaker, the installation shall be carried out in accordance with all applicable installation rules.
- The connections should comply with local electrical code.

CAUTION:

Before attempting to connect or operate this product, please read the label on the bottom.

For U.S. and Canada:

WJ-NV300K

For Europe and other countries:

WJ-NV300K/G

UL listed model No.:

WJ-NV300K

For Canada

CAN ICES-3(A)/NMB-3(A)

For U.S.A.

NOTE: This equipment has been tested and found to comply with the limits for a Class A digital device, pursuant to Part 15 of the FCC Rules. These limits are designed to provide reasonable protection against harmful interference when the equipment is operated in a commercial environment. This equipment generates, uses, and can radiate radio frequency energy and, if not installed and used in accordance with the instruction manual, may cause harmful interference to radio communications.

Operation of this equipment in a residential area is likely to cause harmful interference in which case the user will be required to correct the interference at his own expense.

FCC Caution: To assure continued compliance, (example - use only shielded interface cables when connecting to computer or peripheral devices). Any changes or modifications not expressly approved by the party responsible for compliance could void the user's authority to operate this equipment.

For U.S.A.

The model number and serial number of this product may be found on the surface of the unit. You should note the model number and serial number of this unit in the space provided and retain this book as a permanent record of your purchase to aid identification in the event of theft.

Model No. _____

Serial No. _____

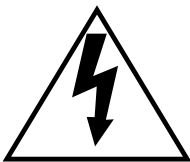
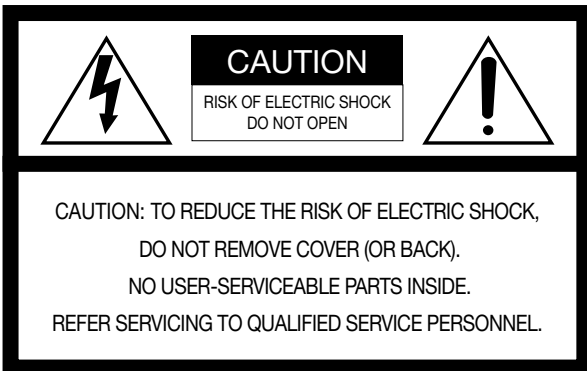

The lightning flash with arrowhead symbol, within an equilateral triangle, is intended to alert the user to the presence of uninsulated "dangerous voltage" within the product's enclosure that may be of sufficient magnitude to constitute a risk of electric shock to persons.



The exclamation point within an equilateral triangle is intended to alert the user to the presence of important operating and maintenance (servicing) instructions in the literature accompanying the appliance.

Power disconnection. Unit with or without ON-OFF switches have power supplied to the unit whenever the power cord is inserted into the power source; however, the unit is operational only when the ON-OFF switch is in the ON position. Unplug the power cord to disconnect the main power for all units.



For U.K.

FOR YOUR SAFETY PLEASE READ THE FOLLOWING TEXT CAREFULLY.

This appliance is supplied with a moulded three pin mains plug for your safety and convenience.

A 5 amp fuse is fitted in this plug.

Should the fuse need to be replaced please ensure that the replacement fuse has a rating of 5 amp and that it is approved by ASTA or BSI to BS1362.

Check for the ASTA mark  or the BSI mark  on the body of the fuse.

If the plug contains a removable fuse cover you must ensure that it is refitted when the fuse is replaced.

If you lose the fuse cover the plug must not be used until a replacement cover is obtained.

A replacement fuse cover can be purchased from your local Panasonic Dealer.

IF THE FITTED MOULDED PLUG IS UNSUITABLE FOR THE SOCKET OUTLET IN YOUR HOME THEN THE FUSE SHOULD BE REMOVED AND THE PLUG CUT OFF AND DISPOSED OF SAFELY. THERE IS A DANGER OF SEVERE ELECTRICAL SHOCK IF THE CUT OFF PLUG IS INSERTED INTO ANY 13 AMP SOCKET.

How to replace the fuse

The location of the differs according to the type of AC mains plug (figures A and B).

Confirm the AC mains plug fitted and follow the instructions below. Illustrations may differ from actual AC mains plug.

Open the fuse cover with a screwdriver and replace the fuse and close or attach the fuse cover.

Figure A

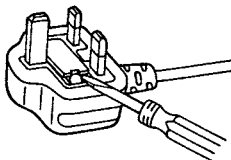
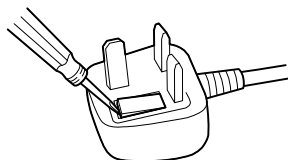

Figure B



We declare under our sole responsibility that the product to which this declaration relates is in conformity with the standards or other normative documents following the provisions of Directives 2006/95/EC and 2004/108/EC.

Wir erklären in alleiniger Verantwortung, daß das Produkt, auf das sich diese Erklärung bezieht, mit den folgenden Normen oder normativen Dokumenten übereinstimmt. Gemäß den Bestimmungen der Richtlinie 2006/95/EC und 2004/108/EC.

Nous déclarons sous notre propre responsabilité que le produit auquel se réfère la présente déclaration est conforme aux normes spécifiées ou à tout autre document normatif conformément aux dispositions des directives 2006/95/CE et 2004/108/CE.

Nosotros declaramos bajo nuestra única responsabilidad que el producto a que hace referencia esta declaración está conforme con las normas u otros documentos normativos siguiendo las estipulaciones de las directivas 2006/95/CE y 2004/108/CE.

Noi dichiariamo sotto nostra esclusiva responsabilità che il prodotto a cui si riferisce la presente dichiarazione risulta conforme ai seguenti standard o altri documenti normativi conformi alle disposizioni delle direttive 2006/95/CE e 2004/108/CE.

Wij verklaren als enige aansprakelijke, dat het product waarop deze verklaring betrekking heeft, voldoet aan de volgende normen of andere normatieve documenten, overeenkomstig de bepalingen van Richtlijnen 2006/95/EC en 2004/108/EC.

Vi erklærer os eneansvarlige for, at dette produkt, som denne deklaration omhandler, er i overensstemmelse med standarder eller andre normative dokumenter i følge bestemmelserne i direktivene 2006/95/EC og 2004/108/EC.

Vi deklarerar härmed vårt fulla ansvar för att den produkt till vilken denna deklaration hänvisar är i överensstämmelse med de standarder eller andra normativa dokument som framställs i direktiv nr 2006/95/EC och 2004/108/EC.

Ilmoitamme yksinomaisella vastuullamme, että tuote, jota tämä ilmoitus koskee, noudattaa seuraavia standardeja tai muita ohjeellisia asiakirjoja, jotka noudattavat direktiivien 2006/95/EC ja 2004/108/EC säädöksiä.

Vi erklærer oss alene ansvarlige for at produktet som denne erklæringen gjelder for, er i overensstemmelse med følgende normer eller andre normgivende dokumenter som følger bestemmelsene i direktivene 2006/95/EC og 2004/108/EC.

Limitation of liability

THIS PUBLICATION IS PROVIDED "AS IS" WITHOUT WARRANTY OF ANY KIND, EITHER EXPRESS OR IMPLIED, INCLUDING BUT NOT LIMITED TO, THE IMPLIED WARRANTIES OF MERCHANTABILITY, FITNESS FOR ANY PARTICULAR PURPOSE, OR NON-INFRINGEMENT OF THE THIRD PARTY'S RIGHT.

THIS PUBLICATION COULD INCLUDE TECHNICAL INACCURACIES OR TYPOGRAPHICAL ERRORS. CHANGES ARE ADDED TO THE INFORMATION HEREIN, AT ANY TIME, FOR THE IMPROVEMENTS OF THIS PUBLICATION AND/OR THE CORRESPONDING PRODUCT (S).

Disclaimer of warranty

IN NO EVENT SHALL Panasonic System Networks Co., Ltd. BE LIABLE TO ANY PARTY OR ANY PERSON, EXCEPT FOR REPLACEMENT OR REASONABLE MAINTENANCE OF THE PRODUCT, FOR THE CASES, INCLUDING BUT NOT LIMITED TO BELOW:

- (1) ANY LOSS OR DAMAGE, INCLUDING WITHOUT LIMITATION, DIRECT OR INDIRECT, SPECIAL, CONSEQUENTIAL OR EXEMPLARY, ARISING OUT OF OR RELATING TO THE PRODUCT;
- (2) ANY INCONVENIENCE, LOSS, OR DAMAGE CAUSED BY INAPPROPRIATE USE OR NEGLIGENT OPERATION OF THE USER;
- (3) UNAUTHORIZED DISASSEMBLE, REPAIR OR MODIFICATION OF THE PRODUCT BY THE USER;
- (4) INCONVENIENCE OR ANY LOSS ARISING WHEN IMAGES ARE NOT DISPLAYED, DUE TO ANY REASON OR CAUSE INCLUDING ANY FAILURE OR PROBLEM OF THE PRODUCT;
- (5) ANY PROBLEM, CONSEQUENTIAL INCONVENIENCE, OR LOSS OR DAMAGE, ARISING OUT OF THE SYSTEM COMBINED BY THE DEVICES OF THIRD PARTY;
- (6) ANY CLAIM OR ACTION FOR DAMAGES, BROUGHT BY ANY PERSON OR ORGANIZATION BEING A PHOTOGENIC SUBJECT, DUE TO VIOLATION OF PRIVACY WITH THE RESULT OF THAT SURVEILLANCE-CAMERA'S PICTURE, INCLUDING SAVED DATA, FOR SOME REASON, BECOMES PUBLIC OR IS USED FOR ANY PURPOSE;
- (7) LOSS OF REGISTERED DATA CAUSED BY ANY FAILURE.

Warranty for U.S.

WJ-NV300K is warranted for three years. Refer to the warranty (accessory) about further information.

Important safety instructions

- 1) Read these instructions.
- 2) Keep these instructions.
- 3) Heed all warnings.
- 4) Follow all instructions.
- 5) Do not use this apparatus near water.
- 6) Clean only with dry cloth.
- 7) Do not block any ventilation openings. Install in accordance with the manufacturer's instructions.
- 8) Do not install near any heat sources such as radiators, heat registers, stoves, or other apparatus (including amplifiers) that produce heat.
- 9) Do not defeat the safety purpose of the polarized or grounding-type plug. A polarized plug has two blades with one wider than the other. A grounding type plug has two blades and a third grounding prong. The wide blade or the third prong are provided for your safety. If the provided plug does not fit into your outlet, consult an electrician for replacement of the obsolete outlet.
- 10) Protect the power cord from being walked on or pinched particularly at plugs, convenience receptacles, and the point where they exit from the apparatus.
- 11) Only use attachments/accessories specified by the manufacturer.
- 12) Use only with the cart, stand, tripod, bracket, or table specified by the manufacturer, or sold with the apparatus. When a cart is used, use caution when moving the cart/apparatus combination to avoid injury from tip-over.



- 13) Unplug this apparatus during lightning storms or when unused for long periods of time.
- 14) Refer all servicing to qualified service personnel. Servicing is required when the apparatus has been damaged in any way, such as power-supply cord or plug is damaged, liquid has been spilled or objects have fallen into the apparatus, the apparatus has been exposed to rain or moisture, does not operate normally, or has been dropped.

Contents

Limitation of liability.....	4
Disclaimer of warranty.....	4
Warranty for U.S.	4
Important safety instructions.....	5
Preface	7
Features.....	7
About the user manuals	8
System requirements for a PC	9
Trademarks and registered trademarks.....	9
Abbreviations.....	10
GPL/LGPL	10
Copyright.....	10
Network security	10
About the face matching function (option).....	11
Notation about the installation and setup of the camera.....	11
Precautions	14
Precautions for installation.....	17
Major operating controls and their functions	18
Front view.....	18
Rear view	20
User/Host management	22
When operating from a PC via a network	22
Operations flow	23
Connection	24
Connection of cameras.....	24
Connection of monitors	25
Connection of a PC.....	26
Connection of extension units	28
About the connector.....	29
How to use the terminals of the ALARM/CONTROL connector	29
Time and polarities of the ALARM/CONTROL connector.....	31
Installation or replacement of the hard disk drives	32
Install the hard disk drives	32
Replace the hard disk drives.....	33
Turn on the recorder	34
Turn on the power of the recorder	34
Turn off the power of the recorder	35
Register the license (Registration Key).....	36
Basic operations.....	38
Setup menu	40
Configure the minimum settings [Easy Start].....	41
Troubleshooting.....	44
Specifications.....	46
Standard accessories.....	47

Preface

The network disk recorders WJ-NV300K and WJ-NV300K/G (hereinafter, recorders) are designed for use within a surveillance system, and record images/audio from up to 32 network cameras (hereinafter, cameras) on the hard disk drives. Number of cameras to be used in the system (9 cameras in basic system) can be increased to 16, 24 and 32 (maximum) by purchasing the Additional Camera Kit (WJ-NVE30, WJ-NVE30W).

Model No.	HDD slot(s)	Number of initial CHs/Maximum number of CHs	RAID function
WJ-NV300K	2	16CH/32CH	Available (*)
WJ-NV300K/G	2	9CH/32CH	Available (*)

(*) RAID5 or RAID6 mode is available when the Extension Unit (WJ-HDE400) is connected.

(When the Extension Unit is connected, the HDD of the recorder is disabled.)

If the Extension Unit is not connected, the mirroring mode can be used with two HDDs of the recorder.

(But the HDD of the Extension Unit is not available for the mirroring mode.)

This recorder supports connection with a monitor equipped with the HDMI (High-Definition Multimedia Interface) connector. Connection using an HDMI cable (optional) offers display of playback/live images with superior quality.

It is possible to operate cameras from this recorder to display images from multiple cameras or switch cameras from which images are to be displayed, etc.

The optional parts described in this installation guide are based on information as of May, 2014. Contact your dealer for further information.

Features

High-definition image monitoring is available

Images from up to 32 cameras with the image capture size of Full HD (1920 x 1080) can be saved as video data. Recording of images with the image capture size of QXGA (2048 x 1536) and of images with the frame rate of 60fps are also available. This recorder also supports the HDMI output to 2 monitors that can display recorded images and live images from the cameras in high definition.

Quick setup and operations

By connecting the mouse (accessory) to this recorder, quick operations are available while viewing a monitor.

By using "Easy Start", the cameras are automatically recognized without operations from the PC.

Recorded images can easily be searched using calendar or time line.

Real-time face matching function (option)

By matching registered face images with a face displayed on live images in real time and by notifying the matching result, it will be possible to check guests or discover suspicious people. That can be an aid to crime prevention.

HDD extension unit

By connecting 2 extension units (WJ-HDE400), operation using up to 20 hard disk drives in the single mode, up to 18 hard disk drives in the RAID5 or RAID6 mode will become available.

SDHC/SD memory card slot and the copy port equipped

It is possible to copy images recorded onto a SDHC/SD memory card (optional) or onto a commercially available external hard disk drive/USB memory. The copied images can be played, printed or saved using the dedicated viewer software.

(Recommended SDHC/SD memory card  page 46)

System configuration

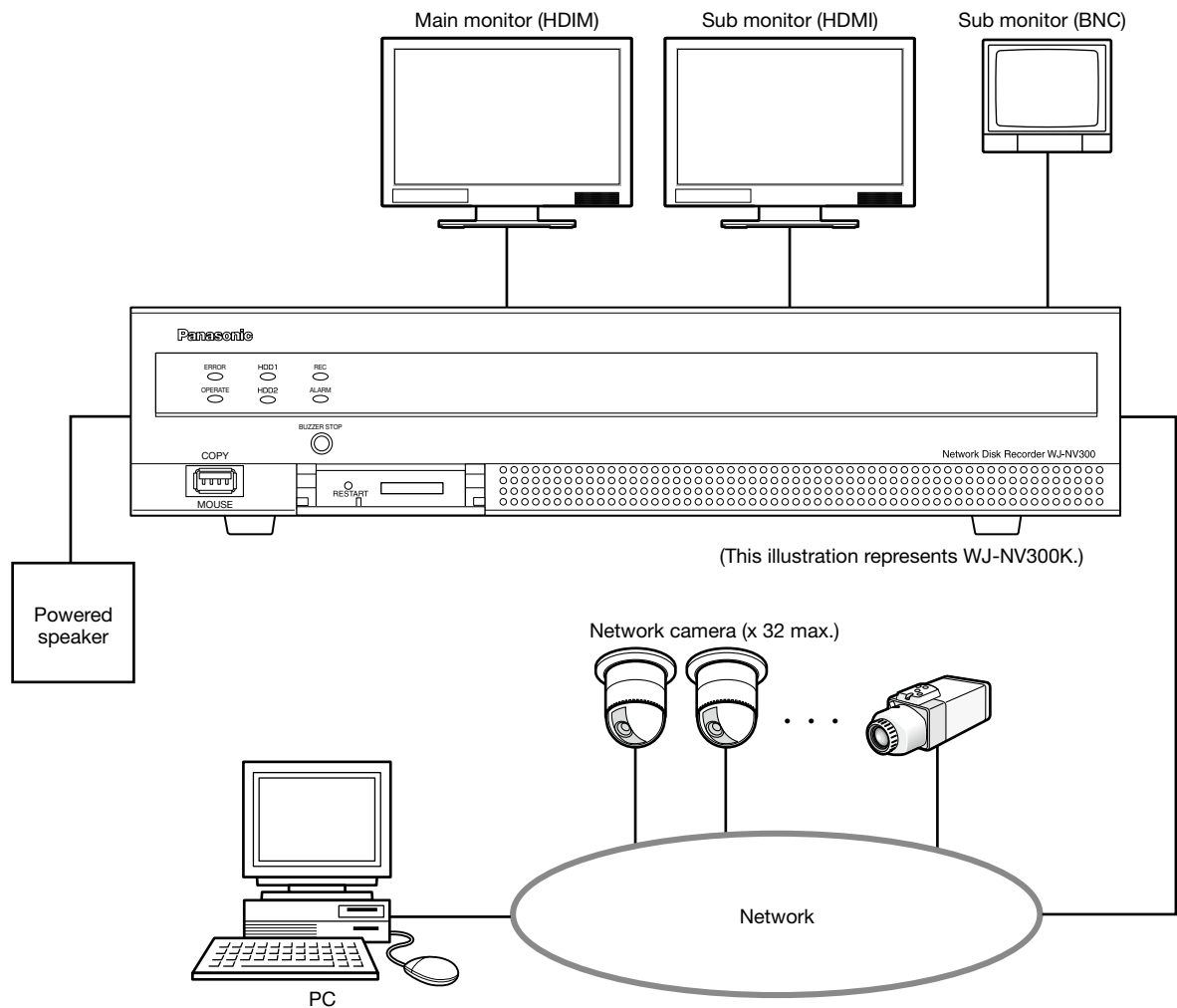

About the user manuals

There are 4 sets of operating instructions for the WJ-NV300K, WJ-NV300K/G as follows.

Installation Guide (this document):	Contains descriptions of how to install/connect this product with devices and descriptions about "Easy start".
Operating Instructions (PDF):	Contains descriptions of how to configure the required settings and how to operate this product. Both operations/configurations using the interface on the product and using a PC via a network are provided.
Quick Reference Guide:	Contains descriptions of how to operate functions frequently used.
Operating Instructions of Additional Business Intelligence Kit (PDF):	Contains descriptions of how to use WJ-NVF30, WJ-NVF30W (option), how to register the license, how to configure the settings and how to operate.

Adobe® Reader® is required to read the PDF files on the provided CD-ROM. When Adobe® Reader® is not installed on the PC, download the latest Adobe® Reader® from the Adobe web site and install it.

Depending on descriptions, the model name of this recorder may be omitted as "NV300" in the manuals and on the setup. The screens used in these operating instructions show the case in which WJ-NV300K is used and 16 cameras are connected.

Refer to "readme.txt" on the provided CD-ROM for further information about the dedicated software (option) that receives and displays the event and error information, compatible cameras and their versions.

Refer to the Panasonic support website (<http://security.panasonic.com/pss/security/support/index.html>) for latest information about the compatible cameras and functions to be added or changed by firmware upgrade.

System requirements for a PC

It is recommended to operate this product using a PC that meets the following system requirements.

OS:	Microsoft® Windows Vista®, Microsoft® Windows® 7*1, Microsoft® Windows® 8.1
Web browser:	Windows® Internet Explorer® 11 (32-bit) Windows® Internet Explorer® 10 (32-bit) Windows® Internet Explorer® 9 (32-bit) Windows® Internet Explorer® 8 (32-bit) Windows® Internet Explorer® 7 (32-bit)
CPU:	Intel® Core™ i7-860
Memory:	4 GB or more
Monitor:	1024 x 768 pixels or more, 24-bit True color or better
Network interface:	10BASE-T/100BASE-TX/1000BASE-T 1 port
Audio:	Sound card (When using the audio function)
Others:	CD-ROM drive: It is necessary to refer to the operating instructions on the provided CD-ROM. DirectX® 9.0c or later Adobe® Reader®: CD-ROM drive: It is necessary to refer to the operating instructions on the provided CD-ROM.

*1 Windows® XP compatibility mode is unavailable.

Important:

- If using a PC that does not meet the above system requirements, it may cause problems such as slow imaging or the browser becomes inoperable.
 - Microsoft® Windows® 7 Starter is not supported.
-

Note:

- Refer to "Notes about versions of Windows®/Internet Explorer®" (PDF) for further information about system requirements for a PC and precautions when using Microsoft® Windows® 8.1, Microsoft® Windows® 7, Microsoft® Windows Vista® or Microsoft® Internet Explorer®.
 - Refer to the Panasonic support website (<http://security.panasonic.com/pss/security/support/index.html>) for information about the latest operation verification of the supported operating systems and web browsers.
-

Trademarks and registered trademarks

- Adobe, Acrobat Reader and Reader are either registered trademarks or trademarks of Adobe Systems Incorporated in the United States and/or other countries.
- Microsoft, Windows, Windows Vista, Internet Explorer, ActiveX, and DirectX are either registered trademarks or trademarks of Microsoft Corporation in the United States and/or other countries.
- Microsoft product screen shot(s) reprinted with permission from Microsoft Corporation.
- Intel and Intel Core are trademarks or registered trademarks of Intel Corporation in the United States and other countries.
- HDMI, the HDMI logo and High-Definition Multimedia Interface are trademarks or registered trademarks of HDMI Licensing LLC in the United States and other countries.
- SDHC Logo is a trademark of SD-3C, LLC.
- All other trademarks identified herein are the property of their respective owners.

Abbreviations

The following abbreviations are used in this manual.

Microsoft® Windows® 8.1 is described as Windows 8.

Microsoft® Windows® 7 is described as Windows 7.

Microsoft® Windows Vista® is described as Windows Vista.

Windows® Internet Explorer® 11, Windows® Internet Explorer® 10, Windows® Internet Explorer® 9, Windows® Internet Explorer® 8 and Windows® Internet Explorer® 7 are described as Internet Explorer.

SDHC/SD memory card is described as SD card or SD memory card.

Network cameras are described as cameras.

GPL/LGPL

- This product contains software licensed under GPL (GNU General Public License), LGPL (GNU Lesser General Public License), etc.
- Customers can duplicate, distribute and modify the source code of the software under license of GPL and/or LGPL.
- Refer to the "readme.txt" file on the provided CD-ROM for further information about the source code of the software contained in this product and copyright notice comprised in the GPL/LGPL software.
- Please note that Panasonic shall not respond to any inquiries regarding the source code.

Copyright

Except for open source software licensed under GPL/LGPL and so on, distributing, copying, disassembling, reverse compiling and reverse engineering of the software provided with this product are all expressly prohibited. In addition, exporting any software provided with this product violating export laws is prohibited.

Network security

As you will use this product connected to a network, your attention is called to the following security risks.

- ① Leakage or theft of information through this product
- ② Use of this product for illegal operations by persons with malicious intent
- ③ Interference with or stoppage of this product by persons with malicious intent

It is your responsibility to take precautions such as those described below to protect yourself against the above network security risks.

- Use this product in a network secured by a firewall, etc.
- If this product is connected to a network that includes PCs, make sure that the system is not infected by computer viruses or other malicious entities (using a regularly updated anti-virus program, anti-spyware program, etc.).
- Protect your network against unauthorized access by restricting users to those who log in with an authorized user name and password.
- After the product is accessed by the administrator, make sure to close the web browser.
- Change the administrator password periodically.
- Apply measures such as user authentication to protect your network against leakage or theft of information, including image data, authentication information (user names and passwords), alarm mail information and FTP server information.

About the face matching function (option)

By registering the license of the additional business intelligent kit, the face matching function, that detects faces whose features are closed to the registered faces by comparing face images in live image with the registered face images, will become available. When the person is detected, it is possible to activate an alarm notification.

To use the face matching function, there are following restrictions.

- Only Camera 1 is available.
- A camera supporting the face detection function is required.
Refer to the "readme.txt" on the provided CD-ROM about the available cameras.
The maximum number of faces that can be detected simultaneously depends on the detection performance of the camera.
- When "Alarm action" is selected for "Mode" of "Advanced face matching alarm setup" (☞ Operating Instructions (PDF)), the settings on the "Advanced recording setup" page for Camera 1 will automatically be changed as follows.
Compression: H.264
Image capture size: SXVGA (1280 x 960)
Frame rate: 5 ips
Image quality: SF
Note that face matching function is unavailable if these settings are changed.
- Face images can be registered only when images recorded under these setting conditions are played back on the recorder.
- It is impossible to register face images displayed on images from the camera while recording is not being performed. It is recommended to perform settings to record images for 24 hours.
- The performance of the face matching function depends on the detection performance of the camera and recorder. When many people appear on images at the same time, the following problems may happen: It may take time for face matching or several face images may not be matched.
- Face matching alarm does not apply event recording.

Notation about the installation and setup of the camera

When performing the installation and setup of the camera, note the following so that the performance of the face matching function is maintained.

- Install the camera so that the width ("a" in the illustration) of a face image becomes 125 pixels or more.

Example) When the image capture size is "1280 x 960", the width of the face image should be 1/10 or more of the whole screen.

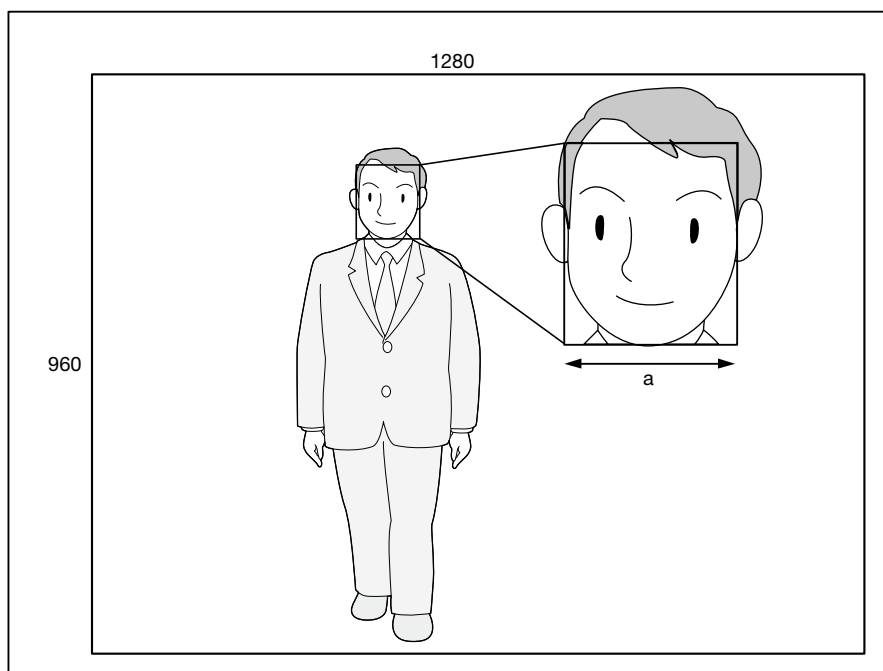

- Adjust the height, angle of depression and vertical angular field of view of the camera so that the angle between the camera and face (θ in the illustration) becomes 15° or less.

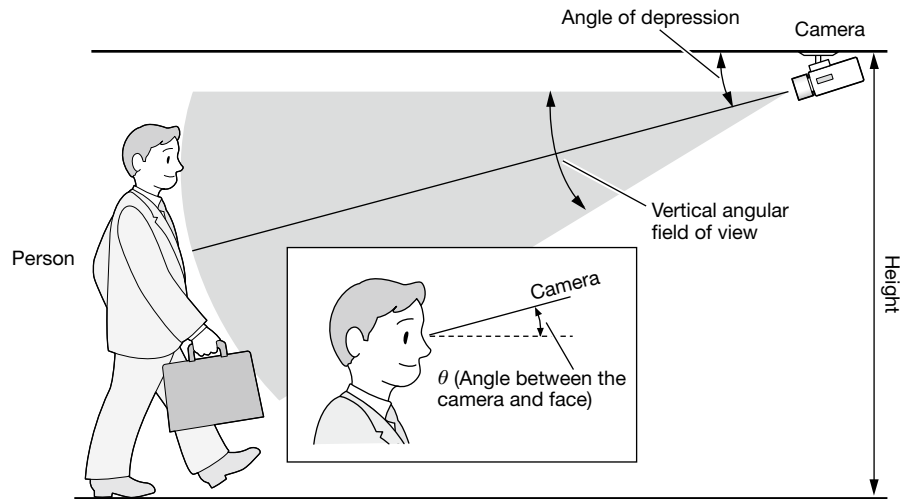

Example of camera adjustment (When shooting a person whose height is 170 cm {5.58 feet})

Height	Angle of depression	Vertical angular field of view (Zoom ratio)	Distance between the camera and a person
2.3 m [7.55 feet]	10°	12° (6x)	3.3 m - 8.5 m {10.83 feet - 27.89 feet}
2.3 m [7.55 feet]	15°	18° (4x)	3.0 m - 5.5 m {9.84 feet - 18.04 feet}

- When the face matching function is activated by the setting, the settings for Camera 1 will automatically be changed as follows. Refer to the operating instructions of the connected camera for further information.

Video encoding format	H.264
Image capture size	1280×960
Frame rate	5 ips
Max bit rate (per client)	4096 kbps (as indication)
Refresh interval	1 s
Super Dynamic	Off
Adaptive black stretch	Off
Back light compensation (BLC)	Off
Shutter speed (Light control mode)	1/250 fix
AGC	On(High)
Black & white mode	Off
DNR	Low
Face detection	On

- By masking an area with remarkable luminance change, it is possible to shoot images on which faces can be recognized more accurately. When shooting images on a place where strong light sources may affect from outside, the following settings can reduce the light influence.

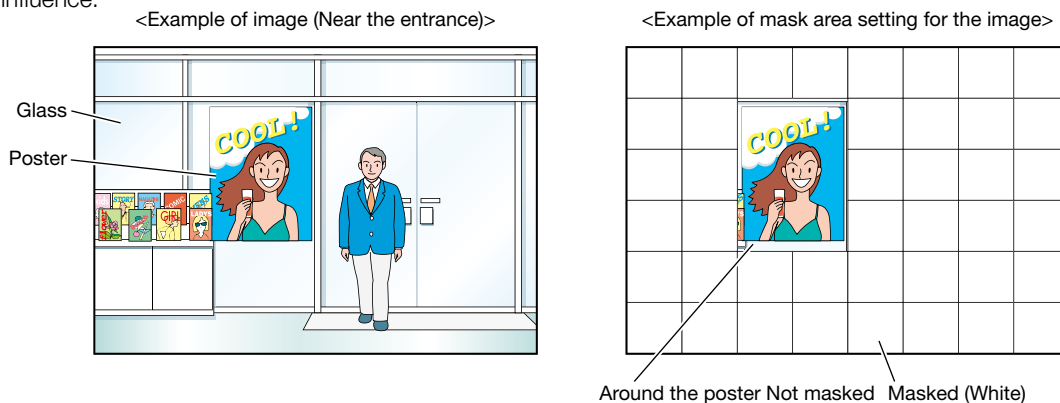

Cases not suited for face matching

The matching accuracy varies depending on installation, settings and adjustment of the camera, ambient environment and object. Therefore, face matching may not be performed in the following cases.

- Illuminance levels are dispersed. (Example: Outdoors)
- Faces are interrupted by such objects as medical masks, sunglasses or helmets.
- Faces are not directed to the front side.
- Photographic subjects are moving quickly.
- Under the influence of strong external light (such as the headlights of a car, rising sunlight or setting sunlight)

To improve the performance of face matching

- Register the target face images from the images recorded by the camera installed under the same conditions.
- Perform settings for the camera so that the camera can shoot face images at a balanced illuminance level both in the day-time and nighttime.
- Install the camera so that the camera can move within the assumed moving pathway of photogenic subjects.
- If people's faces are printed on a poster, perform the setting for "Setup area" (☞ Operating Instructions (PDF)) so that these faces are not targeted for face matching.

<Setting example of matching area>



Precautions

Refer installation work to the dealer.

Installation work requires technique and experiences. Failure to observe this may cause fire, electric shock, injury, or damage to the product.

- Be sure to consult the dealer.

Do not disassemble nor alter this product.

Failure to observe this may cause fire or electric shock.

- Ask your dealer for inspection and repair.

Do not insert any foreign objects.

Do not allow any foreign object or liquid such as water, a metallic part, etc. to enter since it may cause fire or electric shock.

- If it happens, disconnect the power plug from the electric outlet immediately and contact your dealer.

Stop the operation immediately when something is wrong with this product.

When smoke goes up from the product or the smell of smoke comes from the product, continued use will result in fire, injury, or damage to the product.

- Turn off the power of this product immediately, and then contact your dealer.

Avoid placing receptacles that contain liquids such as water on/near this product.

If liquid spills onto this product, it may cause fire or an electric shock.

- If it happens, disconnect the power plug from the electric outlet immediately and contact your dealer.

Clean the power plug periodically to keep it dust free.

Dust can cause the insulation to be damaged and cause a fire.

- When cleaning, disconnect the power plug and wipe with a clean dry cloth.

Do not install this product in an unstable location.

Selecting an inappropriate installation surface may cause the product to fall down or topple over, resulting in injury.

Do not touch this product, power cord and connected cables when thunder is heard.

Failure to observe this may cause electric shock.

Do not connect/disconnect the power plug with wet hands.

Failure to observe this may cause electric shock.

Avoid doing anything that can damage the power cord/plug.

Do not damage, modify, forcefully bend, twist, stretch or bundle the power cord, and do not put a heavy thing on the power cord.

Using a damaged power cord can cause electric shock, short circuit, fire, etc.

- Contact your dealer for repair of the power cord and plug.

Grounding

The power plug of this product is 2-prong plug equipped with a grounding terminal. Use this product after confirming that grounding is properly installed.

If grounding is not installed properly, it may cause ground leakage or damage the product resulting in electric shock.

- Contact the dealer for details. (The grounding installation cost is not included in the price of this product.)

Do not engage in work related to the installation and wiring during the power is on.

Failure to observe this may cause fire or electric shock.

Hold the power plug to disconnect the power cord.

Do not pull the power cord since it can cause fire, electric shock, etc.

Connect the power plug firmly.

If the power plug is not connected firmly, it can cause fire, electric shock, etc.

- Do not use the damaged power cord and loose electric outlets.

Do not connect to outlets or wiring device if their ratings are beyond the specified rating.

If the rating goes over the specified rating such by putting many loads on one electric outlet, it can cause generation of heat resulting in fire.

Do not strike or give a strong shock to this product

Failure to observe this may cause fire or electric shock.

Avoid placing this product in locations which are subject to humidity and dust.

Failure to observe this may cause fire or electric shock.

Do not block the ventilation openings.

Doing so can cause fire since it can raise the temperature inside this product high.

Use the same model or equivalent lithium battery when replacement is required.

Failure to do so may result in generation of heat, battery explosion, fire, etc.

- Contact your dealer for replacement of the lithium battery.

Keep SDHC/SD memory cards (option) away from infants and children.

Otherwise, they may swallow the cards by mistake.

- In this case, consult a doctor immediately.

Precautions for use

Power source

The input power source for this product is 120 V AC 60 Hz (WJ-NV300K), 220 V - 240 V AC 50 Hz/ 60 Hz (WJ-NV300K/G).

Do not connect to the outlet that provides the power to equipment that requires a measurable amount of power (such as a copy machine, air conditioner, etc.). Avoid placing this product in locations where is subject to water.

* The provided power cord(s) is (are) dedicated to the use with this product. Do not use with any other device. Also, do not use any other power cord with this product.

Ambient operating temperature

Use this product at temperatures between +5 °C to +45 °C {41 °F to 113 °F}. Failure to do so may damage the internal parts or cause malfunction.

* Performance and lifetime of hard disk drives are easily affected by heat (used at high temperature). It is recommended to use this product at a temperature of approx. +25 °C {77 °F}.

To cut the power supply

This product has no power switch. To cut the power supply, unplug the power plug of the product from the AC outlet. If it is hard to unplug the power cord due to the installation conditions, connect the power cord of the product to the AC outlet via the circuit breaker of a distribution board or to the AC inlet socket of a power supply control unit.

Built-in backup battery

- Do not expose the built-in battery to excessive heat such as sunlight, fire, etc.
- Before the first use, charge the built-in backup battery (lithium battery) by turning on the power for 48 hours or more. If it is not charged enough, in a case where the power goes down, the operative condition may be different to that before the electric power failure. For example, the internal clock may keep bad time or logs may be lost.
- The built-in battery life is approximately 5 years as an indication of replacement. (The built-in battery life may become shorter depending on the use condition.) Replace the built-in battery after 5 years of use. ("5 years of use" is just an indication of replacement. We are not providing any guarantee of the built-in battery lifetime.) When the built-in battery life runs out, some settings such as the date & time setting will not be saved once the power is turned off.
- Ask your dealer when replacement of the battery is required.

Hard disk drive (HDD)

- Hard disk drives are precise devices. Handle them with care. It is possible to damage them if they are moved while their motors are still running.
- Please be forewarned that any loss of information on the HDD is not guaranteed under any circumstances.
- Do not move or install this product just after turning the power on or off (for around 30 seconds.) The hard disk drives are running.

- The lifetime of hard disk drives is limited by use. Write errors may occur frequently after around 20 000 hours of operation, and the head and motor deterioration may occur after around 30 000 hours of operation. They will reach the end of their lifetime after 30 000 hours of operation if they have been used at the recommended ambient temperature (approx. +25 °C {77 °F}).
- To prevent data loss from disk crashes, it is recommended to keep the ambient operating temperature at approx. +25 °C {77 °F} and to replace them after around 18000 hours of operation.
- When hard disk drive trouble occurs, replace it immediately. Contact your dealer about servicing.

About SDHC/SD memory card

- When using an unformatted SDHC/SD memory card, format it with this product. Recorded data on the SDHC/SD memory card will be deleted when formatted. If an unformatted SDHC/SD memory card or an SDHC/SD memory card formatted with other devices is used, the product may not work properly or performance deterioration may be caused. Refer to the Operating Instructions (PDF) for how to format a SDHC/SD memory card.
- When some SDHC/SD memory cards are used with the product, the product may not work properly or performance deterioration may be caused. Use the SDHC/SD memory cards recommended in (page 46). Memory cards other than SDHC/SD memory card are not supported.
- Refer to page 19 for how to insert/remove a SDHC/SD memory card.

About external storage devices (External HDD and USB memory)

- An external hard disk drive or a USB memory that is compatible with USB2.0 can be connected to the copy port to use as the external storage device.
- The external hard disk drive cannot be formatted with this recorder. Use the external storage device formatted in FAT (FAT16) or FAT32. Refer to the operating instructions of the connected external storage device for the format procedure.
- Do not use any external storage device with the password authentication function since they are not supported.

Prevent condensation from forming

If this happens, it can cause malfunction.

Leave it switched off for around 2 hours in the following cases.

- When this product is placed in an extremely humid place.
- When this product is placed in a room where a heater has just been turned on.
- When this product is moved from an air-conditioned room to a humid and high-temperature room.

About the monitor

When displaying the same image on the PC monitor for a long time, the PC monitor may be damaged.

When this product is not supposed to be used for a certain period

Turn on the power (around once a week), and perform recording/playback to prevent interferences with functions.

Cleaning

- Turn the power off, and then use a soft cloth to clean this product.
- Do not use strong or abrasive detergents when cleaning the body.
- When using a chemical cloth for cleaning, read the caution provided with the chemical cloth product.

Product disposal/transfer

Images saved on the storage device used with this product may lead to personal information leakage. When it is necessary to dispose or give this product to someone, even when for repair, make sure that there is no data on the hard disk drives.

Indication label

Refer to the indication label placed on the surface of this product for the equipment classification and power source, etc.

AVC Patent Portfolio License

THIS PRODUCT IS LICENSED UNDER THE AVC PATENT PORTFOLIO LICENSE FOR THE PERSONAL USE OF A CONSUMER OR OTHER USES IN WHICH IT DOES NOT RECEIVE REMUNERATION TO (i) ENCODE VIDEO IN COMPLIANCE WITH THE AVC STANDARD ("AVC VIDEO") AND/OR (ii) DECODE AVC VIDEO THAT WAS ENCODED BY A CONSUMER ENGAGED IN A PERSONAL ACTIVITY AND/OR WAS OBTAINED FROM A VIDEO PROVIDER LICENSED TO PROVIDE AVC VIDEO.

ADDITIONAL INFORMATION MAY BE OBTAINED FROM MPEG LA, L.L.C.

SEE [HTTP://WWW.MPEGLA.COM](http://www.mpegla.com)

About reboot of this product

In the following cases, this product will automatically reboot to continue recording.

- When the software of this product has detected the internal error and reboot becomes necessary.

Disclaimer of warranty on recorded data

Panasonic assumes no responsibility or liability, directly or indirectly, for failure of recording or editing including loss of data due to any reason or cause which does not exclude repair or maintenance of this product regardless whether the subject is hard disk or other parts.

Precautions for installation

This product is designed to be used indoors.

Panasonic assumes no responsibility for injuries or property damage resulting from failures arising out of improper installation or operation inconsistent with this documentation.

Do not place this product in the following places:

- Locations exposed to direct sunlight
- Locations subject to having strong vibration or impact
- Locations near magnetic field sources such as a television or speakers
- Locations where condensation forms easily, where temperature changes greatly or where humidity level is high
- Locations subject to steam and oil smoke such as a kitchen
- Locations which are not level
- Locations subject to dust
- Locations where it may get wet from rain or water splash

Do not install this product in locations where the product or the cables can be destroyed or damaged by persons with malicious intent.

Place this product horizontally on a level surface.

Do not place this product in an upright position. In addition, clear a space of approx. 5 cm {2 inches} from the both sides, the top, the bottom and the rear.

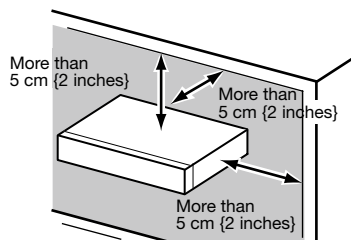

Heat dissipation

To prevent this product from overheating, heed the following. Failure to observe this may cause fire or trouble.

- Do not block the ventilation openings. Maintain the product periodically to prevent dust from blocking openings.
- The lifetime of the cooling fan is limited by use. It is recommended to replace them after around 30 000 hours of operation. Contact your dealer for replacement of the cooling fans.
- Clear a space of more than 5 cm {2 inches} from both sides, the top, and the rear of the product. Do not block the ventilation openings on the front side since this product is designed to cool the hard disk drives by inhaling air from the front.

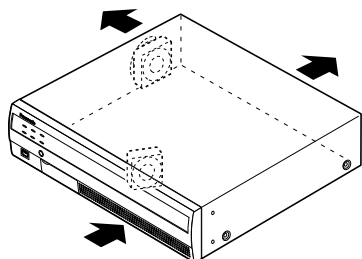

Avoid placing this product near noise sources

If the cables are placed near noise sources such as fluorescent lamps, noises may be produced. In this case, rewire avoiding the noise sources, or move the product to a place far from the source.

Grounding

Confirm that the wire is connected from the SIGNAL GND terminal to earth ground.

A grounding connection must be made before connecting the power plug or this product to the main power supply. When disconnecting the grounding wire, make sure that the power plug of this product is disconnected from the main power supply.

For BNC cable connection

Use only the recommended plug below when connecting the BNC plug to the connectors on the rear panel of this product.

Applicable plug: MIL-C39012C, MIL-C39012/16F or BS CECC2212: 1981

* Suffixes attached to the standards may be updated.

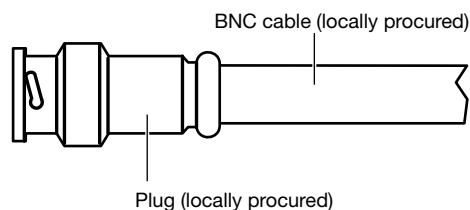

Tip dimensions inside the recommended BNC plug

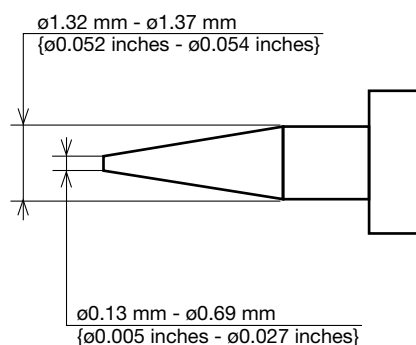

Important:

- A compatible plug shall be used. Failure to observe this may cause trouble such as poor contact. At worst, the connector of this product may be damaged.

Avoid placing receptacles that contain liquids such as water near this product.

If liquid spills onto this product, it may cause fire or an electric shock.

Shielded (STP) LAN cables must be used with this unit to ensure compliance with EMC standards.

Major operating controls and their functions

Front view

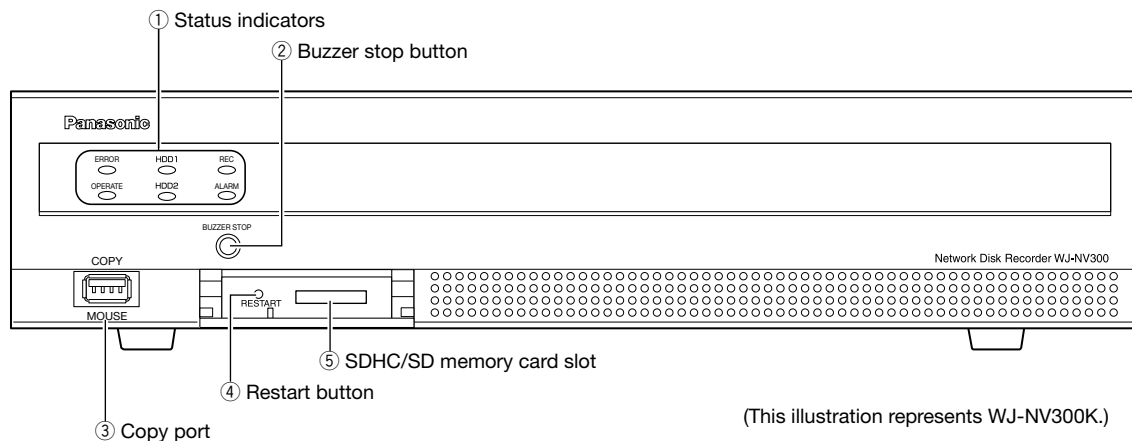

* The copy port has a certain connecting direction. When it is hard to connect, do not forcibly connect and check the direction of the connector.

① Status indicators

ERROR: Blinks when an error that can become a problem for the recorder to run the system occurs.

Blinks red: System error

Blinks orange: Thermal error, cooling fan malfunction, etc.

OPERATE: Lights when the power is on.

HDD [HDD1]/[HDD2]: Indicates the operational status (access/failure) of the respective hard disk drive.

Blinks green: Indicates that the respective hard disk drive is being accessed.

Lights red: Indicates that a fault (or an error) has occurred on a hard disk drive.

Off: Indicates that the respective hard disk drive is not being accessed.

REC: Lights orange when recording is being performed.

ALARM: Blinks when an alarm occurs, and lights when the alarm output stops. This indicator will go off when the [Reset] button (see Operating Instructions (PDF)) is clicked.

② Buzzer stop button [BUZZER STOP]

Press this button to stop the buzzer that started sounding at an alarm/error occurrence. Refer to the Operating Instructions (PDF) for further information about alarms and errors.

③ Copy port [COPY]

Connect an external storage device (external Hard disk drive, USB memory) to this port and copy images and audio recorded on the hard disk drive.

* Mouse connection is also available.

④ Restart button [RESTART]

Press this button to reboot the recorder. When pressing this button, use a sharp object such as a clip.

⑤ SDHC/SD memory card slot

Recorded images and audio can be copied onto an SD memory card inserted in this slot (see page 19).

Insert an SD memory card (option)

Step 1

Open the SDHC/SD memory card slot cover.

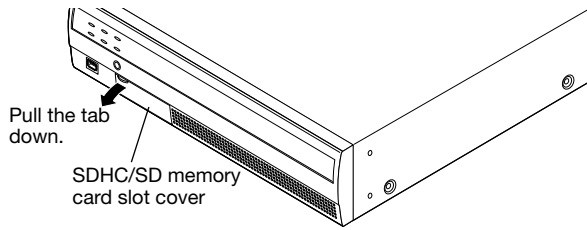

Step 2

Insert a SD memory card to the slot until it clicks. Hearing a click means that the card is properly inserted.

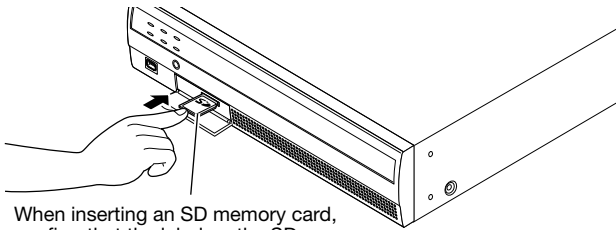

When inserting an SD memory card, confirm that the label on the SD memory card is upside and only the upper right corner of the card has different shape.

Step 3

Close the SDHC/SD memory card slot cover.

Note:

- When removing the SD memory card from the slot, push the card until it clicks and pull it out straight. When pulling out the SD memory card, hold both edges with your fingers.

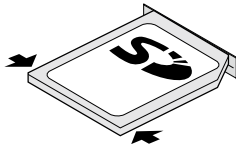

- The SDHC/SD memory card slot cover is designed to come off when an excessive force is applied. In this case, attach the slot cover to the original position.

Rear view

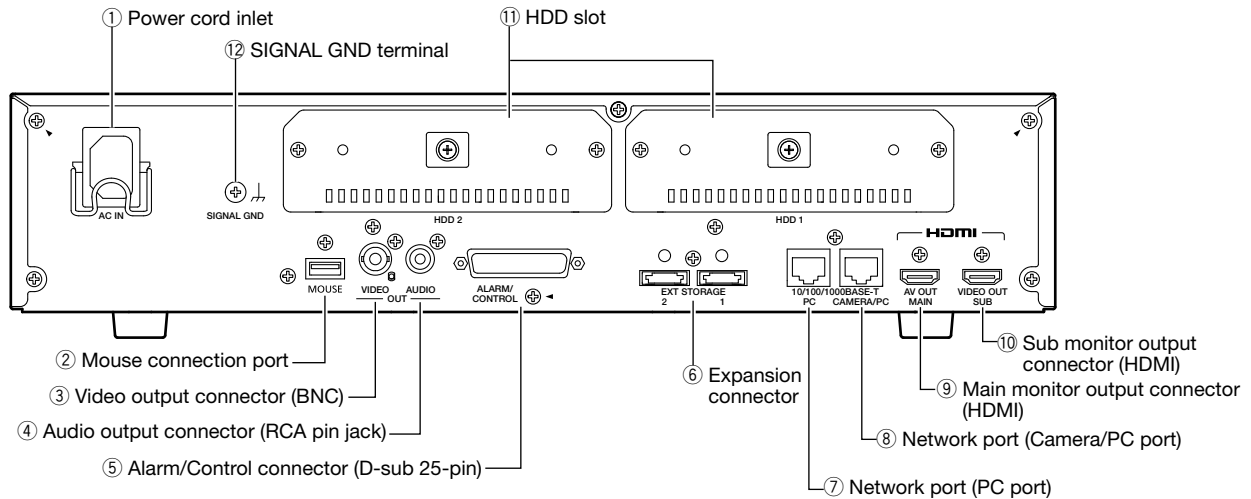

(This illustration represents WJ-NV300K.)

① Power cord inlet [AC IN]

Connect the provided power cord to this inlet. The power plug of the recorder is 2-prong plug equipped with a grounding terminal.

② Mouse connection port [MOUSE]

The provided mouse is connected to this port.

③ Video output connector (BNC) [VIDEO OUT]

Connect a sub monitor (BNC) to this connector. Same images output from the sub monitor output connector (HDMI) will be output from this connector.

④ Audio output connector (RCA pin jack) [AUDIO OUT]

Connect such device as a powered speaker. Same audio output to the main monitor will be output from this connector.

⑤ Alarm/Control connector (D-sub 25-pin) [ALARM/CONTROL]

Connect a control switch to control the recorder using an external device such as a sensor or a door switch or an external alarm device such as a buzzer or a lamp.

⑥ Expansion connector [EXT STORAGE 1/2]

Connect the optional extension unit (WJ-HDE400) to this connector using the dedicated connection cable provided with the extension unit.

⑦ Network port (PC port) [PC]

Connect the recorder with a PC via a network compatible with 10BASE-T, 100BASE-TX or 1000BASE-T. Use this port when the cameras and the PC are connected to different network.

⑧ Network port (Camera/PC port) [CAMERA/PC]

Connect the recorder with a PC and cameras via a network compatible with 10BASE-T, 100BASE-TX or 1000BASE-T. When the port is being accessed, the access indicator (green) blinks. When the port is being linked, the link indicator (orange) lights.

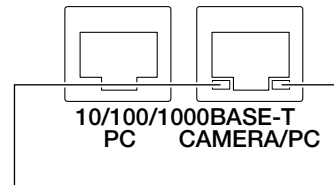

Access indicator

Link indicator

⑨ Main monitor output connector (HDMI) [AV OUT MAIN]

This connector is used to connect to an HDMI-ready monitor (the main monitor). It displays live images, recorded images, or the setup menu of the recorder.

⑩ Sub monitor output connector (HDMI) [VIDEO OUT SUB]

This connector is used to connect to an HDMI-ready monitor (sub monitor). Only the live images will be displayed.

⑪ HDD slot [HDD1/HDD2]

Hard disk drives (locally procured) can be installed into these slots. Contact your dealer for installing/replacing the hard disk drives.

⑫ SIGNAL GND terminal [SIGNAL GND]

Connect this terminal with the SIGNAL GND terminals of the devices in the system for signal ground. When operating the recorder and the devices in the system without signal ground, oscillation or noise may be produced.

How to use the power cord plug brace

Put the hooks of the power cord plug brace on the power cord inlet to fix the power cord plug.

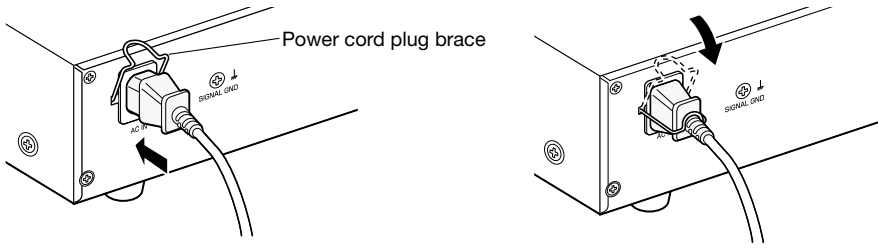

User/Host management

It is necessary to register users who operate the recorder and hosts (PC) that accesses the recorder via a network such as a LAN. Up to 16 users can be registered.

It is possible to register the following for the user information.

Item	Description
User name	User name is to be registered to log in to the recorder. The user name will be entered at the time of login.
Password	Password is to be registered to log in to the recorder together with the user name. The password will be entered at the time of login.
Level	Users are classified into the following levels depending on the available operations. Administrator/Manager/Operator/Viewer/Logged out The administrators can perform all the configurations and operations. It is possible to select in advance the functions that can be controlled by users at other levels. (☞ Operating Instructions (PDF))
Priority level	Priority level indicates the operational priority. Users at each level are assigned the fixed priorities ranging from "0" (Highest) to "4" (Low). Administrator 0 Highest Manager 1 High Operator 2 Viewer 3 Logged out 4 Low When the two or more users at the same level perform the same operation, the recorder will be controlled in accordance with the latest operation.
Default screen	Select a startup screen to be displayed on the main monitor or a PC screen after login from the following.

When operating from a PC via a network

Operation of the recorder can be made using a PC via a network. Up to 8 hosts (PCs) can access the recorder at the same time. When another host (PC) tries to log in to the recorder after 8 hosts (PCs) have already logged in, the user with the lowest priority will be logged out. When the user who is trying to log in has the same priority as the users who have already logged in, the user whose login is the earlier is logged out.

When accessing the recorder from a PC via a network, the authentication method is different depending on the "User authentication" settings of the "Basic" tab under "User management". (☞ Operating Instructions (PDF))

User authentication setting	User/Host to log in	Remarks
Off	Log in as an administrator.	
On	Log in as a registered user.	The login window will be displayed.

Operations flow

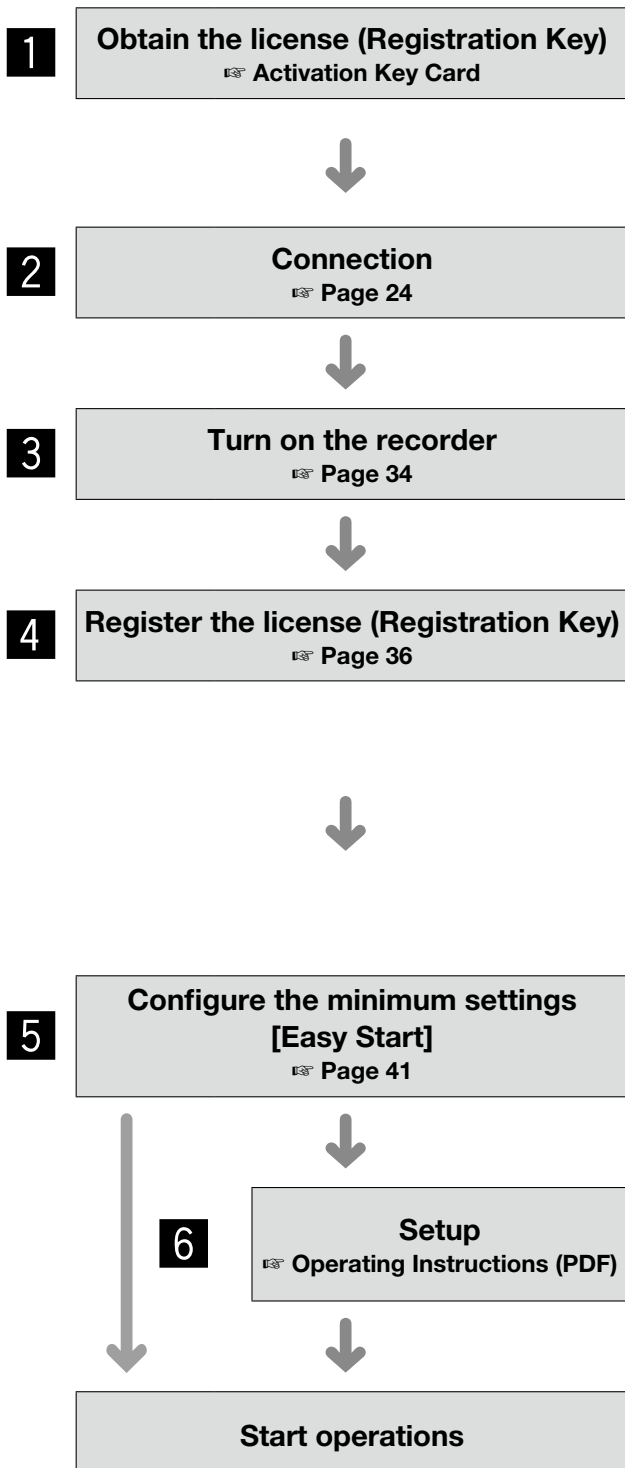

1 Obtain the "Registration Key" of the recorder by following the instructions on the provided Activation Key Card. To increase number of the connected camera, get the additional camera registration key number described on the Activation Key Card packaged in the Additional Camera Kit (WJ-NVE30, WJ-NVE30W: optional).

2 Connect the recorder to each device.

3 Turn on the power of the recorder.

4 Register the Registration Key of the recorder. If necessary, register the "Registration Key" for the Additional Camera Kit or for the Additional Business Intelligence Kit.

Important:

- Be sure to register the "Registration Key" of the recorder. If the "Registration key" of the recorder is not registered, the one for the extension software cannot be registered. A message to prompt the registration will be displayed.

5 Register the date & time and cameras on "Easy Start". When it is not necessary to change other default settings, it is possible to start operations.

6 If necessary, perform the detailed settings for each function.

Note:

- Some functions are not supported depending on the models of the connected cameras. For further information about detailed specifications, refer to the operating instructions of the cameras in use.
-

Connection

Connection of cameras

Up to 32 cameras can be connected to the recorder via a switching hub.

Connect to the Camera/PC port of the recorder.

Use a LAN cable (straight) to connect the recorder and the switching hub.

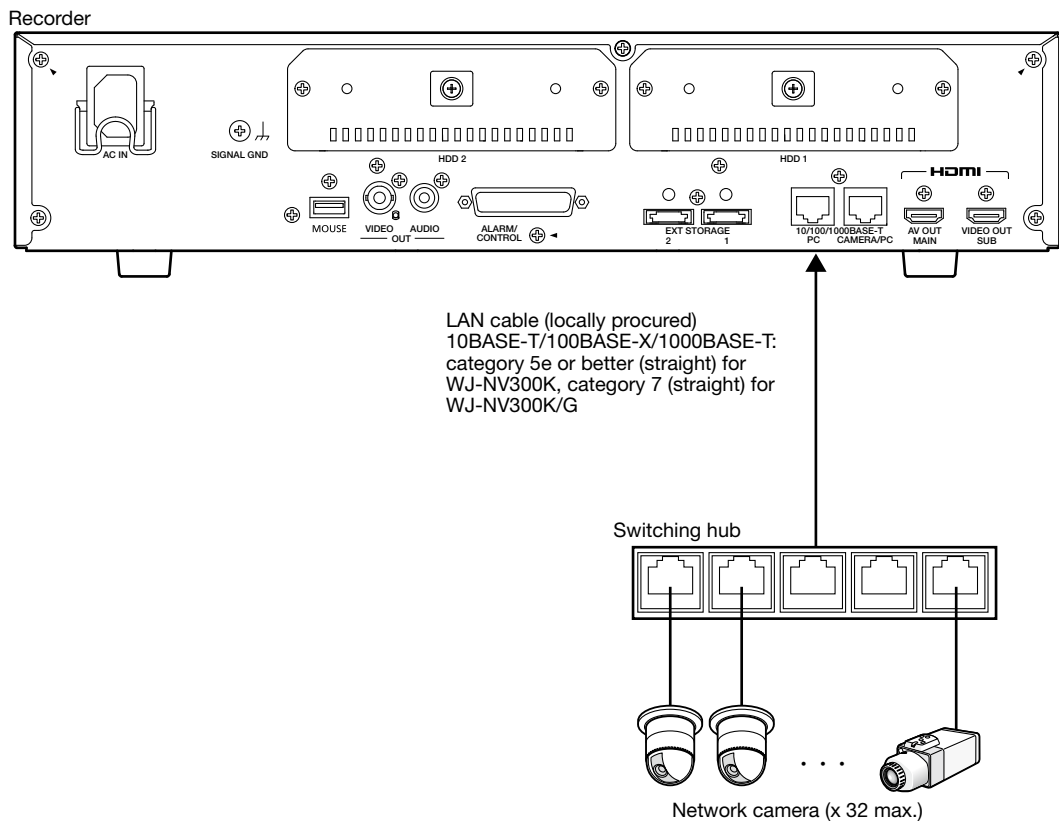

Note:

- For the connection between the recorder and the camera, build the system so that the total bit rate of 128 Mbps is secured as the network bandwidth.
 - Make sure to use the wired network to connect with the recorder even for the cameras equipped with the wireless LAN function.
-

Connection of monitors

Connect a main monitor (to be used to display live images, recorded images or the setup menu) and a sub monitor (to be used to display live images only) to the HDMI (video/audio output) connectors using HDMI cables (optional).

Connect a sub monitor (BNC) to the video output connector using a BNC cable (locally procured).

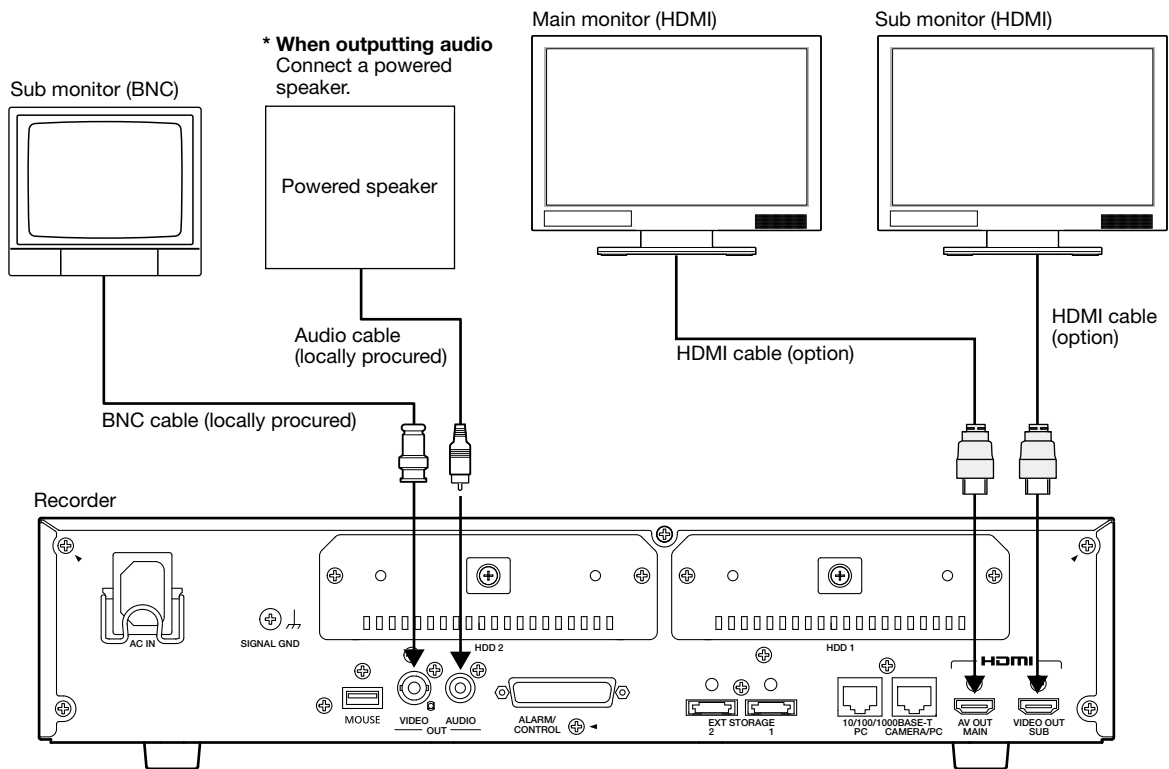

Note:

- Use "High Speed HDMI® Cable".
 - To maintain the stable performance without deteriorating the image quality, use an HDMI cable whose length is 10 m {32.81 feet} or less.
 - Audio will be output from the monitor when the monitor is connected with an HDMI cable.
 - Same audio output from the main monitor will be heard from the speaker connected with an audio cable.
 - No audio will be heard from the sub monitor (HDMI) connected with an HDMI cable.
-

Connection of a PC

Connect this recorder and a PC via a switching hub.

When the PC and the camera are on the same network, connect the PC to the Camera/PC port.

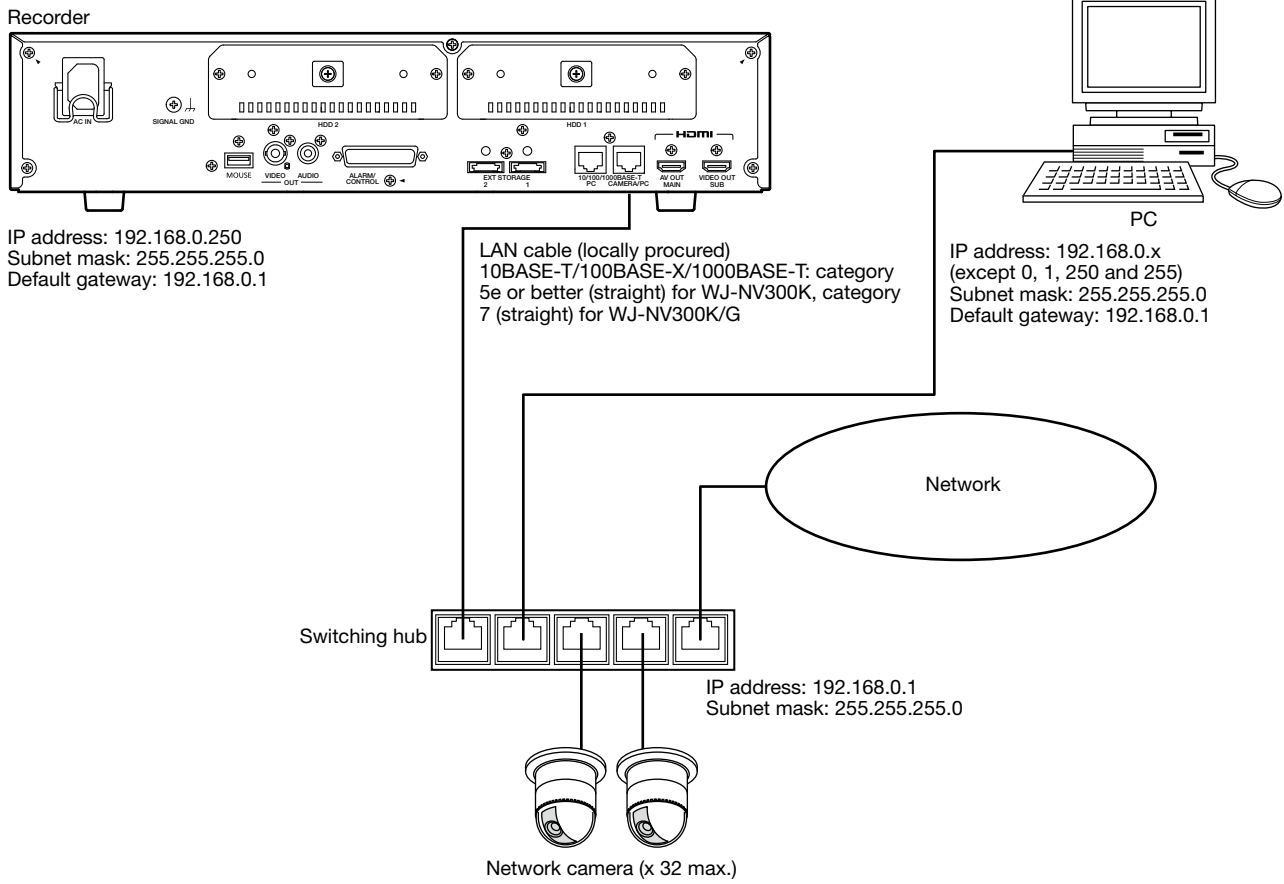

When the PC and the cameras are not on the same network and it is impossible to directly access the cameras from the PC, connect the PC to the PC port.

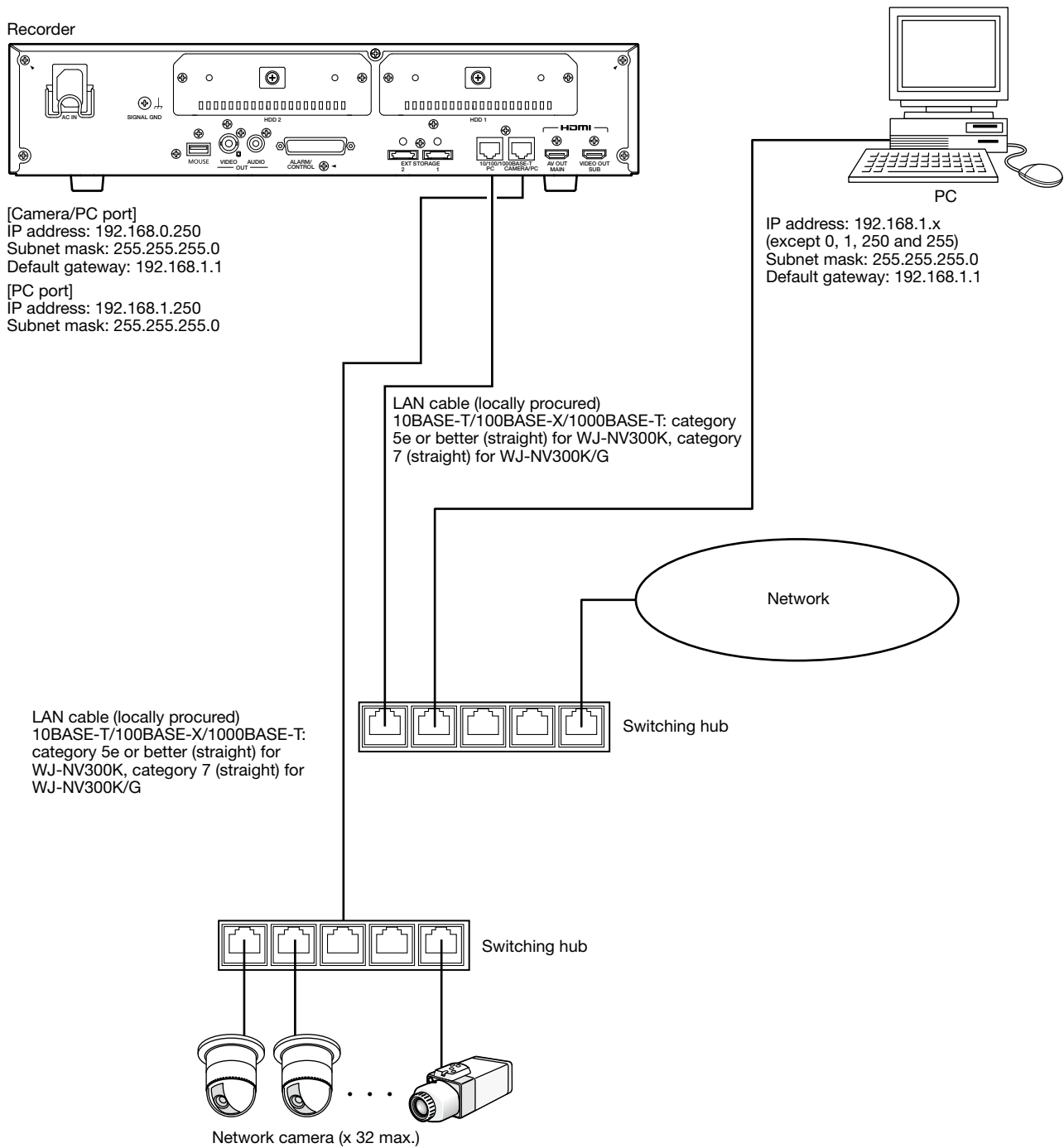

Note:

- Cameras shall be connected to the camera/PC port. If the camera is connected to the PC port, the camera will not be detected automatically.

Connection of extension units

Up to 2 extension units (optional) can be connected with a single network disk recorder. Connect the recorder and the extension unit using the connection cable provided with the extension unit.

Connect the extension units (WJ-HDE400) as shown in the illustration below. Refer also to the operating instructions of the extension unit.

When the extension units are connected, the RAID5 or RAID6 function will become available.

Refer to the Operating Instructions (PDF) for descriptions of how to use the RAID function.

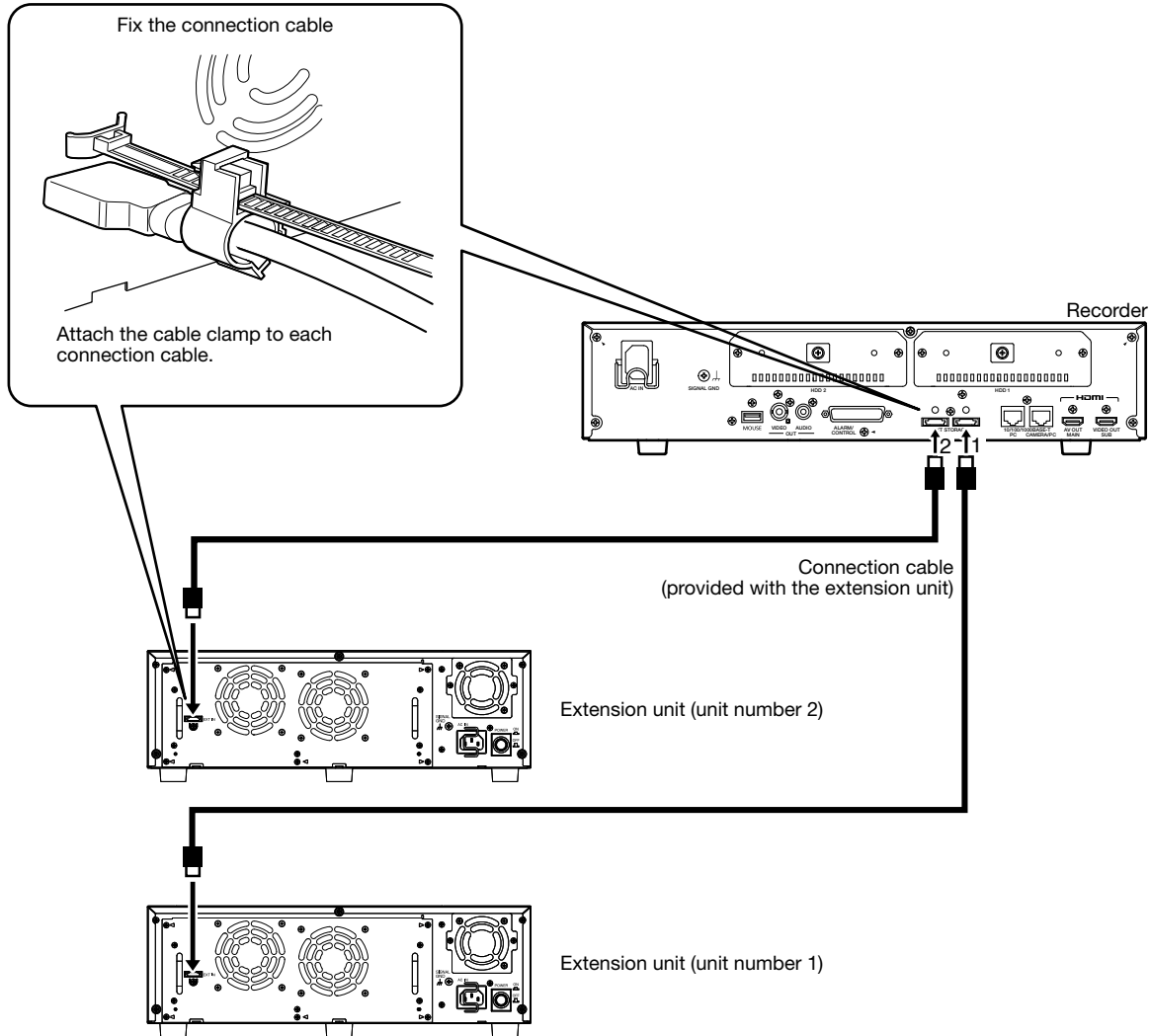

Important:

- Use only the dedicated connection cable provided with the extension unit when connecting the recorder and the extension unit.
 - Fix the connection cable firmly using the cable clamp provided with the extension unit. When the cable is not connected firmly or when it is disconnected, the system may become unstable or recording may fail.
 - Do not bind the looped cable.
-

About the connector

How to use the terminals of the ALARM/CONTROL connector

This connector is used when connecting an external device such as a sensor that outputs alarm signals or when installing an external alarm device such as a buzzer or a lamp. The connector to be used should be compatible with the pin array.

Pin array

The pin array is different from other Panasonic recorders. Make sure that the connection is correct referring to the following.

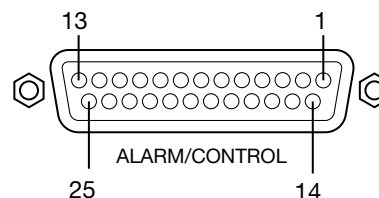

Pin No.	Signal	Operation	Remarks
1	Alarm input 1	Event action will be performed according to the settings.	Make contact input
2	Alarm input 2		
3	Alarm input 3		
4	Alarm input 4		
5	Alarm input 5		
6	Alarm input 6		
7	Alarm input 7		
8	Alarm input 8		
9	Alarm input 9		
10	Network error output*	Signal output upon detection of a broken Ethernet link	Open collector output 24 V DC max., -100 mA
11	Alarm reset input	Canceling the alarm display	Make contact input
12	N/A		
13	Signal ground		
14	Signal ground		
15	Face matching output	Signal output at the occurrence of a face matching alarm	Open collector output 24 V DC max., -100 mA
16	HDD error output*	Signal output upon detection of an HDD error	
17	Camera error output	Signal output upon detection of a camera error	
18	Recorder error output*	Signal output upon detection of a recorder error	
19	Recording error output*	Signal output upon detection of a recording error	
20	Time adjustment signal input	According to the signal input from the other device, the time of this recorder will be adjusted to the hour (00 minutes 00 seconds).	Make contact input
21	Alarm output	Alarm signal will be supplied at an event occurrence (Except for a face matching alarm)	Open collector output 24 V DC max., -100 mA
22	N/A		
23	N/A		
24	N/A		
25	+5 V output	+5 V output	200 mA max.

* Refer to the "About the error logs and the network logs" (Operating Instructions (PDF)) for further information about each error output.

Connection for the auto time adjustment function

When a signal output from the other device is supplied to the time adjustment signal input (pin no. 20) and the time difference between the recorder and the other device is 29 minutes or less, the clock of the recorder will be set to the time set for the other device.

When a signal output is supplied to the recorder 29 minutes before/after the hour, the clock of the recorder will be set to the hour (nn:00:00). ("nn" is the hour.)

Example:

- Signal is supplied at 2:50:00 pm → Set at 3:00:00 pm
- Signal input supplied at 3:28:45 pm → Set at 3:00:00 pm
- Signal is supplied at 3:29:30 pm → Time will not be adjusted.

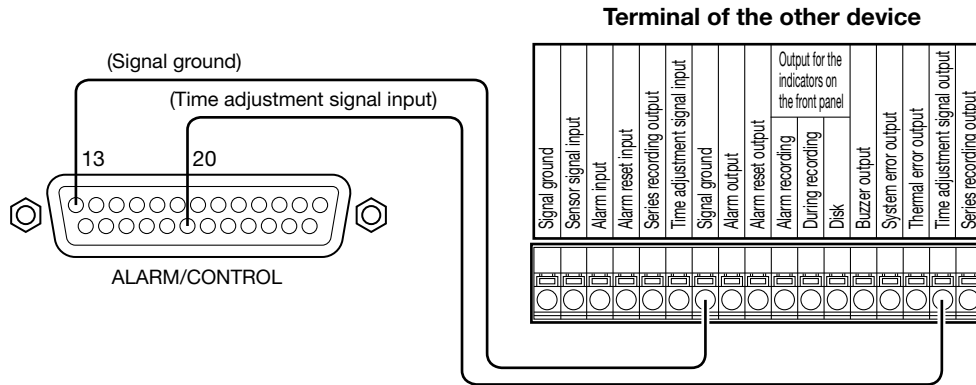

Important:

- The clock will not be adjusted during recording.

Note:

- When adjusting the time using the time adjustment signal input, select "On" for "Auto time adjustment". (See Operating Instructions (PDF))

Connection of the control output

When an alarm device such as a buzzer or a lamp is connected, the signal output from pin no. 10 and pin nos. 15 - 19 can be used to notify the status by sounding a buzzer or lighting a lamp.

The connection example of the HDD error output (pin no. 16) is as follows.

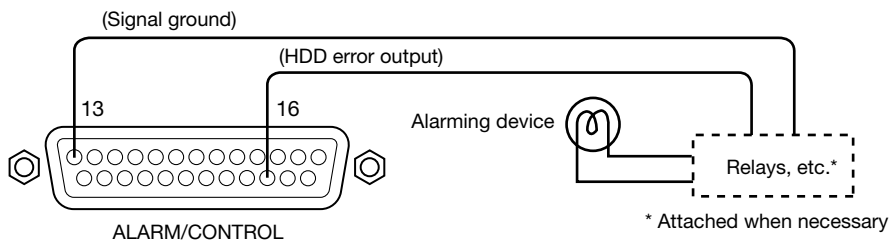

Alarm connection

When a signal output from the other device is supplied to the Alarm input 1 to 9 terminals (pin nos. 1 - 9), recording or an alarm action will be performed in accordance with the settings.

When an alarm device such as a buzzer, a lamp, etc., is installed outside, connect them to the Alarm output terminal (pin no. 21).

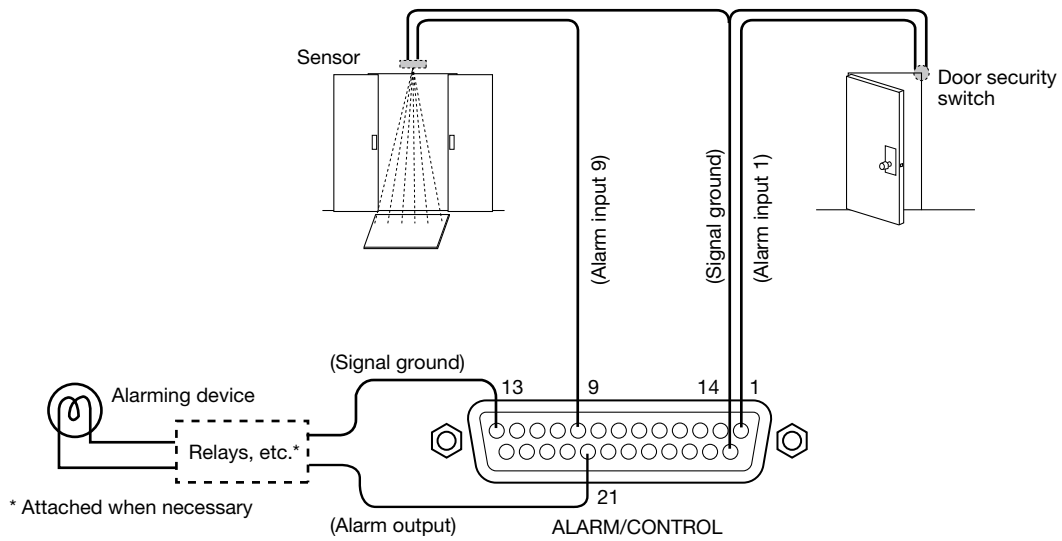

Time and polarities of the ALARM/CONTROL connector

Terminal	Activation time	Remarks
Alarm input	100 ms or more	N.O.: L active N.O.: H active
Network error output	At an error occurrence until the period selected for "Error output duration" has passed*	L active
Alarm reset input	100 ms or more	L active
Face matching output	The set time on the setup menu	L active
HDD error output	At an error occurrence until the period selected for "Error output duration" has passed*	L active
Camera error output	At an error occurrence until the period selected for "Error output duration" has passed* or the camera reset	L active
Recorder error output	At an error occurrence until the period selected for "Error output duration" has passed*	L active
Recording error output	At an error occurrence until the period selected for "Error output duration" has passed*	L active
Time adjustment signal input	Input: 100 ms or more	L active
Alarm output	The set time on the setup menu	L active

* The error output duration is configured on the "Advanced setup" menu - the "Maintenance" page - "System setup" of the setup menu. (☞ Operating Instructions (PDF))

Note:

- During "L active (Low active)", the logic will be implemented when the voltage level of signal is low.
- During "H active (High active)", the logic will be implemented when the voltage level of signal is high.

Installation or replacement of the hard disk drives

Before installing the hard disk drives, turn off the power of the recorder first. When replacing the hard disk drives, the procedures will be same as those of installation. When installing or replacing the hard disk drives for playback use only (hard disk drives that are formerly used for recording), perform the link process.

Important:

- When securing the hard disk drives to the HDD brackets, do not mistake the direction of the connectors. (Do not install the hard disk drives in the opposite direction.)
- When installing hard disk drives, use a low-torque powered screwdriver or a torque screwdriver to tighten screws with the specified torque.
- Hard disk drives are precise devices. Handle with care while keeping the following in mind.
 - Do not subject the hard disk drive to any vibration or impact.
 - Before touching the hard disk drive, eliminate static electricity by touching a steel locker, etc. When holding the hard disk drive, hold the both sides of the hard disk drive.
 - Do not touch the circuit board or the connectors to prevent the hard disk drive from damaging by static electricity.
- Contact your dealer for hard disk drives that works on the recorder. Please be forewarned that operation with any hard disk drive other than the specified models is not guaranteed under any circumstances.
- When using multiple hard disk drives, use the same model.
- If different models are used together, even when the capacities of them are the same, the available capacity may be a few percent smaller.

Note:

- Hard disk drives are locally procured. Contact your dealer for purchasing, installing, and replacing the hard disk drives.

Install the hard disk drives

Installation or replacement of the hard disk drives

Step 1

Turn off the power of the recorder. (☞ Page 35)

Step 2

Remove the HDD bracket screws (x2) on the HDD slots on the rear panel of the recorder, and pull out the HDD bracket.

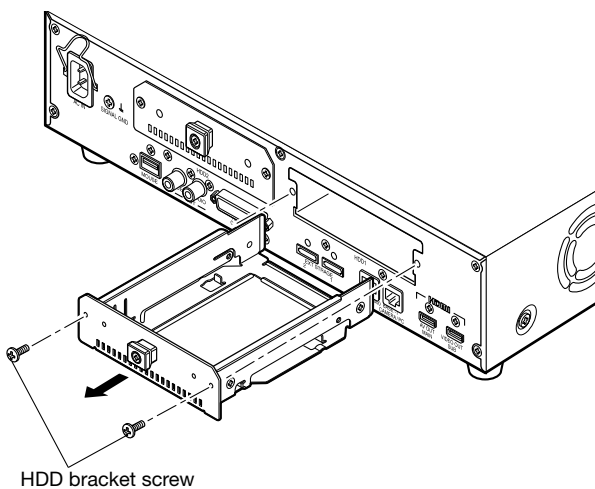

Step 3

Install the hard disk drive into the HDD bracket using 4 HDD fixing screws (accessories).

Tightening torque for the screws: 0.49 N·m {0.36 lbf·ft}

HDD fixing screw (accessory)

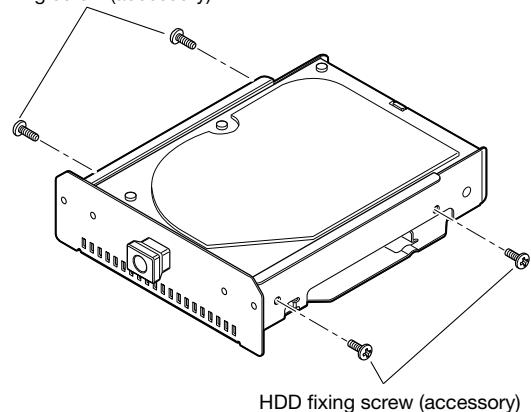

HDD fixing screw (accessory)

Step 4

Insert the HDD bracket with the hard disk drive all the way into the HDD slot, and secure the HDD bracket with the screws removed in Step 2.

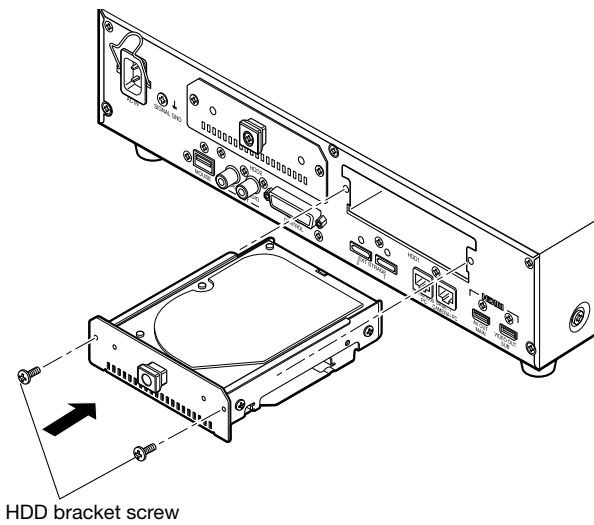

Step 5

Turn on the power of the recorder. (☞ Page 34)

- New hard disk drive will be formatted automatically. When the formatting is completed, the hard disk drive will become operable. When the hard disk drive is formerly used for recording, perform the link process (☞ Operating Instructions (PDF)) on the "HDD management" page. The status of hard disk drive can be checked on the setup menu - the "Maintenance" page - the "HDD information" tab. (☞ Operating Instructions (PDF))

Replace the hard disk drives

When replacing a hard disk drive with another one, it is necessary to perform the removal process. In this case, do the following.

Step 1

Perform the removal process of the hard disk drive. (☞ Operating Instructions (PDF))

Step 2

Turn off the power of the recorder. (☞ Page 35)

Step 3

Pull out the HDD bracket from the rear panel of the recorder by referring to Step 2 of "Install the hard disk drives" (☞ page 32).

Step 4

Install the hard disk drive into the HDD bracket by referring to Step 3 of "Install the hard disk drives" (☞ page 32).

Step 5

Insert the HDD bracket with the hard disk drive into the HDD slot by referring to Step 4 of "Install the hard disk drives" (☞ page 33).

Step 6

Turn on the power of the recorder. (☞ Page 34)

- New hard disk drive will be formatted automatically. When the formatting is completed, the hard disk drive will become operable. When the hard disk drive is formerly used for recording, perform the link process (☞ Operating Instructions (PDF)) on the "HDD management" page. The status of hard disk drive can be checked on the setup menu - the "Maintenance" page - the "HDD information" tab. (☞ Operating Instructions (PDF))

Turn on the recorder

Turn on the power of the recorder

Turn on the power of the recorder. When using the recorder for the first time, register the license for the recorder. (☞ Page 36)

Step 1

Connect the provided power cord to the power cord inlet on the rear panel of the recorder, and insert the power plug to an outlet whose rating is as follows.

WJ-NV300K: 120 V AC, 60 Hz

WJ-NV300K/G: 220 V - 240 V AC, 50 Hz/60 Hz

→ The [OPERATE] indicator will light, the system check of the recorder and the hard disk drives will start, and the startup window will be displayed on the main monitor.



Important:

- Never turn off the power of the recorder during startup.

Note:

- If the license for the recorder has not been registered yet, the message asking you to register the "Registration Key" will be displayed.

This window will not be displayed after Registration Key is registered.

Refer to the provided Activation Key Card for how to get Registration Key.

Step 2

If the "Registration Key" for the recorder has not been registered yet, register the "Registration Key" by following the procedures on page 36.

Note:

- When the "Login" window is displayed during operation after startup, enter the user name and password. Refer to the Operating Instructions (PDF) for descriptions of how to operate.
- The default administrator name and password are as follows.

Administrator name : ADMIN
Password : 12345

- If the "Registration Key" for the recorder is once registered, the message asking you to register the "Registration Key" will not be displayed from the next time.

Turn off the power of the recorder

Turn off the power of the recorder. Follow the procedure below to turn off the power.

Step 1

During recording, "Off" for "Recording mode" on the "REC & event" page - [Advanced setup] tab of the setup menu to stop all recordings. (↔ Operating Instructions (PDF))

Step 2

Unplug the power plug from the outlet after confirming that the [REC] indicators are off.

→ The [OPERATE] indicator will go off.

Note:

- Be sure to perform the operation to start recording (select "On" for "Recording mode") after turning on the power of the recorder again.

Important:

- Remove the plug from the outlet if not operating the recorder for a long period.
 - Turn on the power (around once a week), and perform recording/playback to prevent interferences with functions.
-

Register the license (Registration Key)

When using the recorder for the first time, or to increase number of the cameras to be connected, it is necessary to register the license (Registration Key) of the recorder.

Important:

- In the following cases, the recorder must be rebooted by clicking the [Restart] button. The licenses will not be effective until the recorder is rebooted.
 - When the Registration Key of the recorder is registered
 - When the licenses of the additional camera kit or any other additional/extension kit is added
- The added cameras shall be registered on "Easy start" (Page 41) or on the "Camera registration" tab. Each setting value is the default. Configure each setting according to your needs.

Step 1

Obtain the "Registration Key" for the recorder by following the instructions on the provided "Activation Key Card". To increase number of the connected camera, get the additional camera registration key number described on the Activation Key Card packaged in the Additional Camera Kit (WJ-NVE30, WJ-NVE30W: optional) When using the extra functions, obtain the "Registration Key" for Additional Business Intelligence Kit WJ-NVF30, WJ-NVF30W (option). Refer to the "Activation Key Card" for further information.

Step 2

Start the recorder. (Page 34)

- When the system check is complete, the operational screen will be displayed on the main monitor. If the license for the recorder has not been registered yet, the message asking you to register the license will be displayed.

Step 3

Click the [Setup] button.



- The setup menu will be displayed.

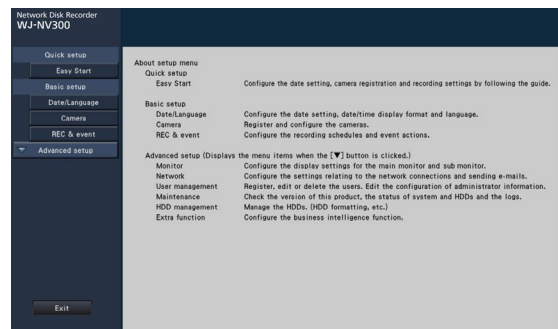

Step 4

- Click [Advanced setup] - [Maintenance] - the [System management] tab on the setup menu.

- The "System management" page will be displayed.

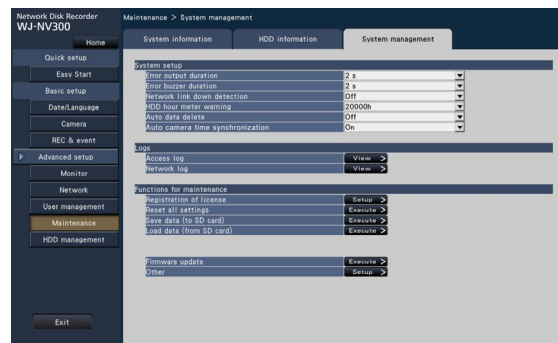

Step 5

Click the [Setup >] button of [Registration of license].

→ The registration window will be displayed.

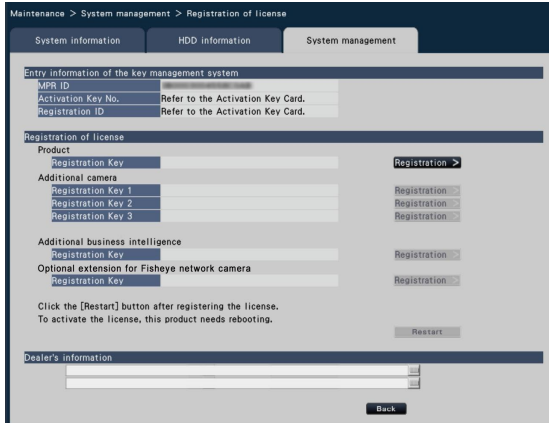

Step 6

Click the [Registration >] button of "Product" - "Registration Key".

→ The "Registration key input" window will be displayed.

Step 7

Enter the "Registration key" for the recorder in the "Registration key" field using the on-screen keyboard, and click the [Registration] button.

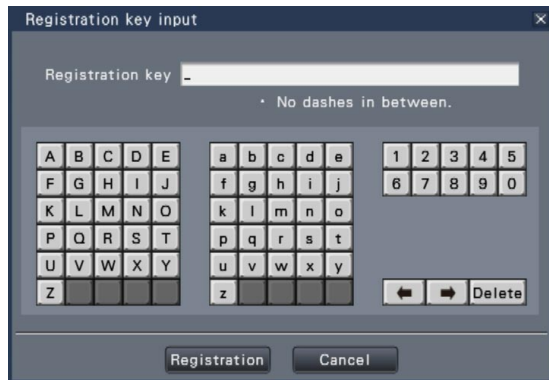

→ The "Registration key input" window will return to the registration window.

Note:

- When an error message is displayed, enter the effective "Registration Key" again on the entry field.

Step 8

To increase number of the connected camera, enter the additional camera registration key number obtained in step 1 to the "Registration Key1-3" fields under "Additional camera" on the "Registration of license" page shown in step 5. When using the extra functions, enter to the "Registration Key" field under "Additional Business Intelligence". The operations are the same as those of Step 6 and 7.

Note:

- Register the license for the recorder before registering that for the Additional Business Intelligence Kit. They cannot be registered in the reverse order.

Step 9

Click the [Restart] button on the registration window to register the license.

→ The recorder will reboot and each license will become effective.

Basic operations

The recorder can be operated using the provided mouse connected to the mouse connection port on the rear side of the recorder.

It is also possible to perform operations and some settings of the recorder from the web browser. Refer to the Operating Instructions (PDF) for descriptions of how to operate from the web browser and the configurable settings using the web browser.

Step 1

Connect the provided mouse to the mouse connection port on the rear side of the recorder.
→ The mouse cursor will be displayed on the main monitor.

Step 2

Left-click the desired buttons and tabs on the screen. (Hereinafter, "Left-click..." will be described as "Click..." in this document.)
When the entry field has the [▲] and [▼] buttons or the [▼] button, the setting value can be changed using the mouse wheel.
When no operation is made for 10 seconds or more, the mouse cursor will be hidden. The mouse cursor will be displayed again when the mouse is moved.

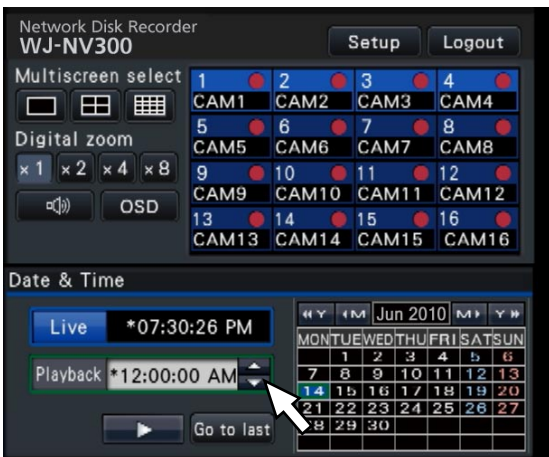

Step 3

Click the [Setup] button.
→ The top screen of the setup menu will be displayed.

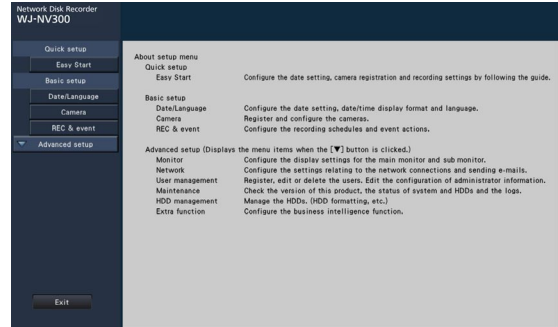

Note:

- If a setting window is in a list form and the [▼] button exists on the title column, it is possible to change all the settings in the same row at the same time.

Camera	Model	Compression	Image capture size	Basic setup		
				Rate	Quality	Audio
1	IPVCL01-001	H.264	VGA(640x480)	10 ips	FQ	Off
2	IPVCL01-001	H.264	VGA(640x480)	10 ips	FQ	Off
3	IPVCL01-001	H.264	VGA(640x480)	10 ips	FQ	Off
4	IPVCL01-001	H.264	VGA(640x480)	10 ips	FQ	Off
5	IPVCL01-001	H.264	VGA(640x480)	10 ips	FQ	Off
6	IPVCL01-001	H.264	VGA(640x480)	10 ips	FQ	Off
7	IPVCL01-001	H.264	VGA(640x480)	10 ips	FQ	Off
8	IPVCL01-001	H.264	VGA(640x480)	10 ips	FQ	Off

About the operation of on-screen keyboard

Use the on-screen keyboard to enter characters for the setting items. When clicking the [🖱️] icon beside the entry field, the on-screen keyboard will be displayed, and it will become possible to enter characters by clicking the character keys on the keyboard.

On-screen keyboard screen

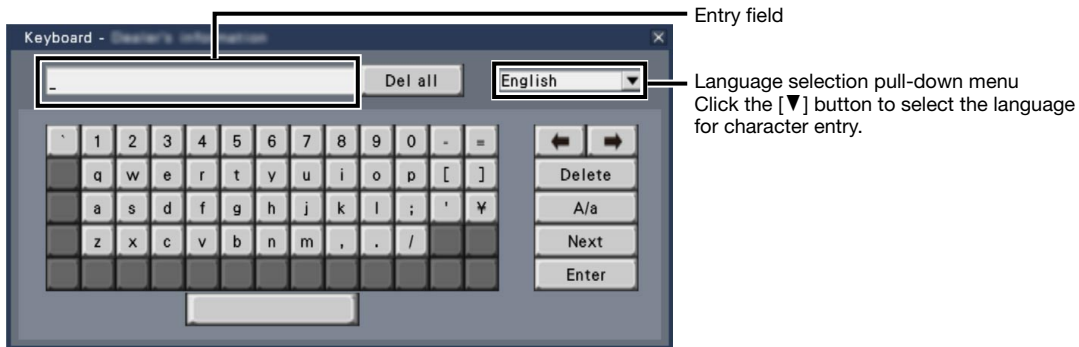

[Del all] button

Deletes all the characters in the entry field.

[←]/[→] button

Move the cursor in the entry field to either direction.

[Delete] button

Deletes a character pointed by the cursor in the entry field.

[A/a] button

This button changes the characters to be entered between capital letters and small letters.

[Next] button

Changes the keys to be displayed for character entry.

The displayed keys are changed as follows:

Keys for the language selected by the language selection pull-down menu → Combination characters → Special characters

[Enter] button

Determines the entered characters and closes the on-screen keyboard.

Note:

- Basic operations are also applied to the "Login" window and registration window for license.
 - Click the [x] button to close the window without determining the entered characters.
-

Setup menu

Configuration of each setting item in the setup menu should be completed in advance to use this recorder.

The setup menu has the following levels for the setting items. On "Easy Start", the minimum settings required to operate the recorder will be performed, but other settings will remain default. On the [Basic setup] or [Advanced setup] page, the settings can be customized in accordance with a variety of operational modes.

The following is the example of the setup menu that describes the features and operations.

The setup menu will be displayed when clicking the [Setup] button (☰ page 38) at the upper right corner of the operational screen on the main monitor.

The buttons of the setup pages will be displayed on the left column of the setup menu.

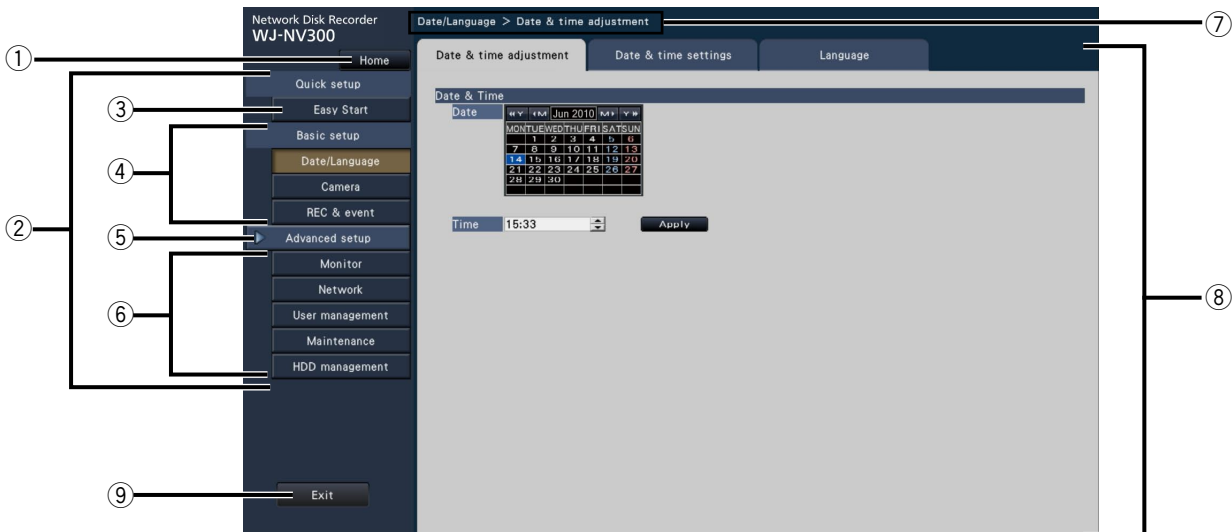

① **[Home] button**

It is possible to return to the top screen (☰ page 38) of the setup menu from any setup page.

② **Setup menu panel**

Displays buttons of the setup pages.

③ **[Easy Start] button**

It is possible to configure the minimum settings required to operate the recorder, such as date & time and camera registration.

④ **[Basic setup] – Setup page buttons**

Each "Basic setup" page will be displayed.

⑤ **[Advanced setup] button**

The buttons to open the corresponding setup pages of the "Advanced setup" menu will be displayed. When clicking this button again, the buttons will be hidden.

⑥ **[Advanced setup] – Setup page buttons**

Each "Advanced setup" page will be displayed.

⑦ **Hierarchical display**

The name of the current setup page will be displayed in the hierarchy. The tab name will also be included.

⑧ **Setup page**

Displays each setup page. If the current setup page is composed of two or more tabs, it is possible to change the page display by clicking the tabs.

⑨ **[Exit] button**

Applies the settings to the recorder and closes the setup menu to return to the operational screen.

Except for some cases, the descriptions of this document follow the hierarchical display and setup pages.

Important:

- If the settings are applied, all login users will be forcibly logged out.
-

Configure the minimum settings [Easy Start]

The minimum settings required to operate the recorder, such as the date & time, camera registration, recording, can be configured on the setup menu - the "Quick setup" menu - "Easy Start".

First, configure the minimum settings on "Easy Start", and to configure more advanced settings, go to each setup page.

Available settings on "Easy Start"

- Date & time of the recorder
- Camera registration
- * Other settings will remain default or will be conformed to the camera settings.
- * To reset the time, do not use "Easy Start", and go to "Basic setup" menu - "Date/Language" page.
- Order change of the registered camera numbers
- Recording frame rate and image quality

Step 1

Click the [Easy Start] button on the top screen of the setup menu.

Refer to "Basic operations" (☞ page 38) for how to display the setup menu.

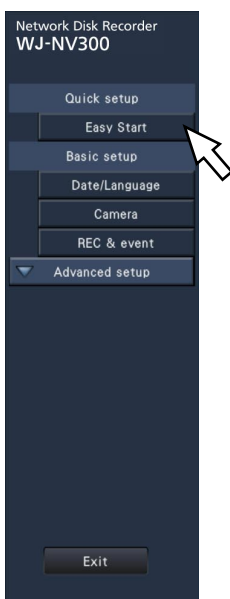

→ The setup menu for the date & time will be displayed.

Step 2

Set the date & time.

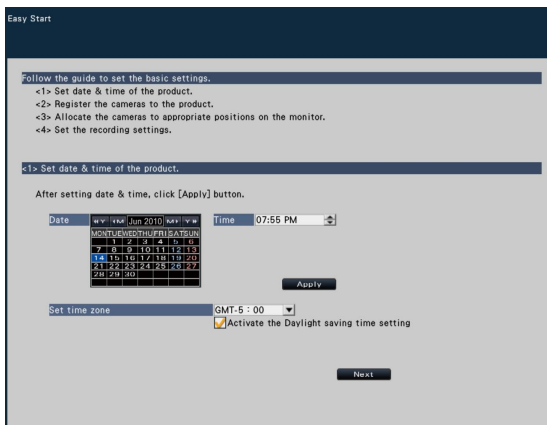

[Date]

Set the current date. Select the year, month and day from the calendar.

[<<Y]/[Y>>] button: Selects the previous or next year.

[<M]/[M>] button: Selects the previous or next month.

[Time]

Set the current time.

Step 3

Click the [Apply] button after setting the date & time.

→ The second will be set to "00".

[Set time zone]

Select your time zone.

GMT-12:00 - GMT+13:00

Default: GMT-5:00 (WJ-NV300K)

GMT (WJ-NV300K/G)

Marking the checkbox for [Activate the Daylight saving time] will active daylight saving time.

Step 4

Click the [Next] button.

→ The camera registration window opens.

Step 5

Register the cameras connected to the recorder.

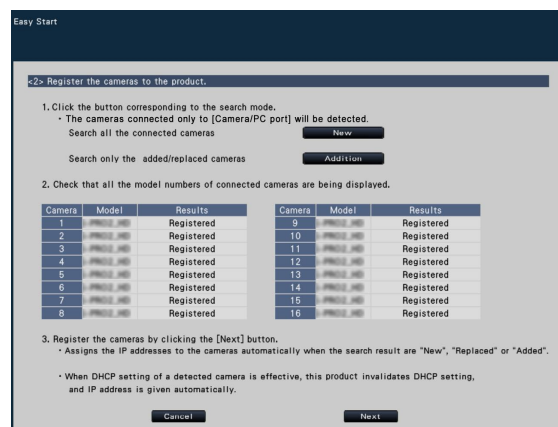

Note:

- To use the existing IP address of the connected cameras, refer to "Detect cameras for registration [Detect cameras]" (☞ Operating Instructions (PDF)) instead of "Easy start".

Note:

- Before the settings, register the cameras into the network. Only the cameras added by license registration will be detected even though more cameras than the registered license number are connected. It is recommended to disconnect unnecessary cameras.
 - Cameras shall be connected to the Camera/PC port. Cameras will not be detected if they are connected to the PC port.
-

[New] button

Detects all the connected cameras.

The models and results of the detected cameras will be displayed.

Make sure that the model numbers of all the connected cameras are being displayed.

[Addition] button

Detects only the added or replaced cameras.

The models and results of the detected cameras will be displayed.

Make sure that the model numbers of all the added or replaced cameras are being displayed.

Important:

- The system will assign new IP addresses to all the connected cameras (including currently-operated cameras) by clicking [New] button.
 - Cameras newly added after the operation start will be registered in the default settings. To conform the settings to those of the registered cameras, perform the settings for the added cameras.
 - For the video encoder (WJ-GXE500), only the camera connected to CH1 will be detected. The channels CH2 to CH4 are needed to be registered from the setup menu.
-

[Camera]

Up to 32 cameras can be connected. After the license is registered (page 36), 16, 24 or 32 cameras can be connected.

[Model]

When Panasonic cameras are used, the model numbers will be displayed.

[Results]

New: Displayed when the camera is newly connected to the recorder.

Replaced: Displayed when the camera has been replaced by another one.

Added: Displayed when the camera connection is added to the recorder.

Registered: Displayed when the camera has already been registered.

Lost: Displayed when the registered camera is not detected.

Blank: No camera is detected.

Note:

- If "Lost" is displayed or the column is left blank, check if the power of the camera is turned on, and make sure that cables are properly connected.
-

Step 6

Click the [Next] button.

→ IP address will be given to the cameras newly connected, replaced or added, and the images from the camera will be displayed on the operational screen.

Note:

- On "Easy Start", it is impossible to register the cameras in other subnets via the same router.
 - For the security enhancement, changing of the IP address of the camera will become impossible when 20 minutes have passed after the power is turned on. Perform the camera detection within 20 minutes, or turn off the power of the camera and turn it on again if more than 20 minutes has passed. Refer to the operating instructions of the camera for further information. When 20 minutes have passed after the power of the camera is turned on, "ONVIF" may be detected depending on the models of Panasonic cameras. In such a case, turn off the power of the camera and turn it on again to perform the camera detection.
 - When "On" is selected for the "DHCP" setting of the detected cameras, the recorder will forcibly change the setting to "Off" to give the IP addresses automatically.
 - When the [Cancel] button is clicked, the top screen of "Easy Start" (the menu to set the date & time) without applying the camera detection result will be displayed.
-

Step 7

When you wish to change the registered camera numbers, it is possible to change the order of the camera numbers.

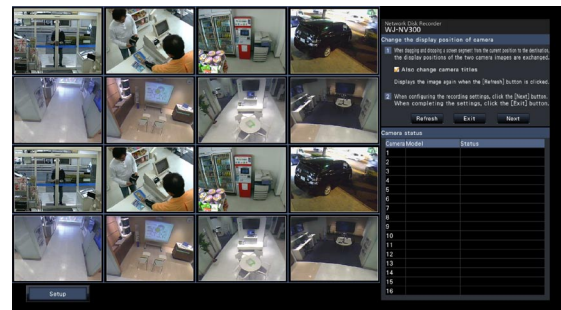

Images from the cameras will be displayed on the monitor from the upper left corner to the right in order of the camera number (1, 2 ... 16: The monitor screen will change according to the number of the camera in use; 9 cameras on 9-screen, 16 cameras on 16-screen, and 24 or 32 cameras on 2 of 16-screen)

To interchange camera numbers, drag the camera image to be moved with the mouse and drop on the desired position. If the camera titles are to be interchanged as well, mark the "Also change camera titles" checkbox.

[Camera status]

The model numbers and statuses of each camera will be displayed in a list.

Displaying image: Displays the images from the camera using the IP address that is newly registered or that has already been registered.

Changing IP address: Images are being obtained from the camera whose IP address has been changed.

Undetectable: Cannot obtain images from the camera.
Authentication error: Failed in the authentication to display images from the camera.

Important:

- If "Undetectable" is displayed, check the camera connections, and retry the camera registration.
 - If "Authentication error" is displayed, initialize the camera and retry the camera registration by referring to the operating instruction of the camera.
 - If the registered camera is not correctly detected or if you wish to change the camera settings, change the registered information on the "Basic setup" menu - the "Camera" page - the "Camera registration" tab. (E38) Operating Instructions (PDF)
-

[Refresh] button

Obtain the latest camera image after interchanging cameras.

[Exit] button

Exits the setup menu and returns to the top screen of the setup menu.

[Next] button

Proceeds to the settings for recording.

Step 8

Perform the settings for recording. If the settings are performed on "Easy Start", the settings will be applied to all the cameras.

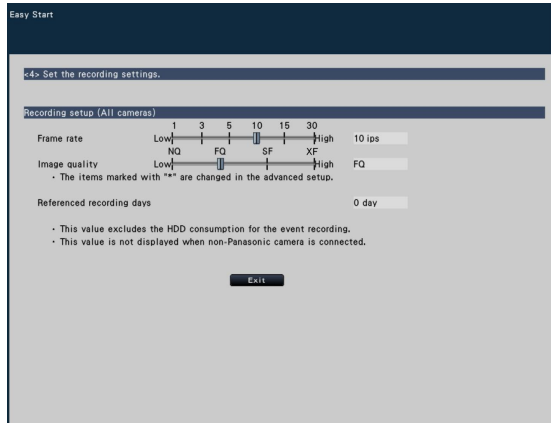
**[Frame rate]**

Select the recording frame rate.

1 ips/ 3 ips/ 5 ips/ 10 ips/ 15 ips/ 30 ips

Default: 10 ips

Note:

- To apply 60 ips, configure on "Advanced recording setup" on the "Recording setup" tab under "REC & event" of "Basic setup".
-

[Image quality]

Selects the image quality of recorded images.

NQ (Normal): Standard quality

FQ (Fine): High quality

SF (Super Fine): Super fine quality

XF (Extra Fine): Extra fine quality

Default: FQ

Note:

- If "XF" is selected when the compression method of the camera is "MJPEG", "SF" will be set instead of "XF".
-

[Referenced recording days]

Calculates and displays the total number of days for which recording on the hard disk drives is available.

Note:

- The referenced recording days will be calculated based on the assumption that recording is started on Monday.
- The HDD consumption for the event recording will be excluded.
- If a camera manufactured by other than Panasonic is used, the value of "Referenced recording days" will not be displayed.
- When configured to perform recording in high resolution and high quality, recording may sometimes not be performed at the specified rate.

When there may be possibility to fail recording at the specified rate while using only Panasonic cameras, the confirmation window will be displayed.

Step 9

Click the [Exit] button.

→ Saves the settings and returns to the top screen of the setup menu.

Troubleshooting

Before asking for repairs, check the symptoms with the following table.

Contact your dealer if a problem cannot be solved even after checking and trying the solution in the table or a problem is not described below.

Symptom	Cause/solution	Ref. pages
Power is not turned on.	<ul style="list-style-type: none"> Is the power plug connected to the outlet firmly? Confirm the cable is firmly connected. 	–
	<ul style="list-style-type: none"> Check if the power cord is properly inserted into the power socket of the recorder. Check if it is connected firmly. 	21
Camera images are not displayed on the monitor	<ul style="list-style-type: none"> Is the lens cap of the camera detached from the camera? Check whether the lens cap is removed. 	–
	<ul style="list-style-type: none"> Is the power of the camera and connected devices on? Check whether the power is supplied to the camera and the devices. 	–
	<ul style="list-style-type: none"> Confirm that the cables are connected correctly and firmly. Confirm the cables are firmly connected. 	26, 27
	<ul style="list-style-type: none"> Is the monitor luminance appropriately adjusted, or is the contrast appropriately adjusted? Check whether the settings are appropriate. 	–
	<ul style="list-style-type: none"> Users who have logged into the system may not be authorized to display the images from cameras. Check the user level settings of these users. 	Operating Instructions
Part of the displayed image is missing.	<ul style="list-style-type: none"> This phenomenon is caused by dispersion of display area on the monitor. This is not a malfunction. 	–
	<ul style="list-style-type: none"> When a function to automatically enlarge the images in the connected monitor is enabled, some part of the images may not be displayed depending on the photographic subject. 	–
Image is blurred.	<ul style="list-style-type: none"> Is the lens of the camera soiled with dirt or dust? Check whether the lens of the camera is clean. 	–
Cannot open the setup menu.	<ul style="list-style-type: none"> Users who have logged into the system may not be authorized to display the setup menu. Check the user level settings of these users. 	Operating Instructions
	<ul style="list-style-type: none"> Isn't it the sub monitor you are currently operating? The setup menu cannot be displayed on the sub monitor. 	20
The images or embedded characters displayed on the monitor look blurry.	<ul style="list-style-type: none"> Depending on the photographic subject or HDMI monitor that is connected, images or embedded characters may look blurry. This phenomenon is not trouble. 	–
No alarm action is taken.	<ul style="list-style-type: none"> Check if alarm input signals are properly input to the ALARM/CONTROL connector at the rear panel. 	31
	<ul style="list-style-type: none"> Are the settings of the alarm terminals appropriate? 	Operating Instructions
	<ul style="list-style-type: none"> Is "Off" or "Recording only" selected for "Mode"? Check whether the settings are appropriate. 	Operating Instructions
The "Communication error :cc" indication is displayed on the main monitor.	<ul style="list-style-type: none"> Confirm that the camera is connected correctly and firmly. Check the camera connection. 	26
	<ul style="list-style-type: none"> If the connection is appropriate, the cable may be broken or the camera may be out of order. Consult the dealer. 	–

Symptom	Cause/solution	Ref. pages
The "Thermal error" indication is displayed on the main monitor.	<ul style="list-style-type: none"> • Check if the fan is malfunctioning. 	18
	<ul style="list-style-type: none"> • Check if the the ventilation openings or the cooling fan of the recorder is blocked, and also check for dust collected around the ventilation openings. 	17, 18
	<ul style="list-style-type: none"> • The ambient operating temperature is +5 °C to +45 °C {41 °F to 113 °F}. The "Thermal error" is displayed based on the internal thermal information of the HDD. If the "Thermal error" indication is displayed, it is recommended to change the installation environment so that the ambient temperature is maintained at approx. +25 °C {77 °F}. When the "Thermal error" indication is displayed frequently, contact your dealer. 	15
The clock of the recorder may keep bad time.	<ul style="list-style-type: none"> • The clock function of the recorder is accurate within ±30 seconds per month. To keep the correct recording, set the time periodically, or enable the auto time adjustment function on the rear panel terminal, or configure the system using the NTP function so as to keep the correct current time. 	–
	<ul style="list-style-type: none"> • Has the built-in battery sufficiently been charged? Charge the built-in backup battery by turning on the power for 48 hours or more. 	15
	<ul style="list-style-type: none"> • Is the built-in backup battery depleted? The built-in battery life is around 5 years as an indication of replacement. (Lifetime may be shortened depending on the use environment.) 	15
The HDD indicator is being lit red/blinking red.	<ul style="list-style-type: none"> • The hard disk drive is faulty. Contact your dealer. 	18
Cannot copy data on the SD memory card. Image data saved on the SD memory card cannot be searched or played back.	<ul style="list-style-type: none"> • Is a recommended SD memory card used? • Some SD memory cards cannot be used with this recorder. It is recommended to use Panasonic's SD memory card. • Is the SD memory card formatted? • Are data copied to the SD memory card? 	46 Operating Instructions

Inspect the power cord, power plug and connectors periodically.

Symptom	Cause/solution	Ref. pages
The power cord insulation is damaged.	<ul style="list-style-type: none"> • The power cord, connector, or power plug is damaged. This may result in electric shock or a fire. Unplug the power plug from the AC outlet immediately, and refer to qualified service personnel. 	–
The power cord, plug and connectors get hot during use.		
The power cord gets hot when bent or stretched.		

Specifications

• General

Power source:	120 V AC 60 Hz (WJ-NV300K) 220 V - 240 V AC 50 Hz/60 Hz (WJ-NV300K/G)
Power consumption:	55 W (when 2 HDDs (4TB) are installed)
Ambient operating temperature:	Main body: +5 °C - +45 °C {41 °F - 113 °F} Mouse (accessory): +5 °C - +40 °C {41 °F - 104 °F}
Ambient operating humidity:	5% - 90% (no condensation)
Maximum operating altitude:	2000 m {6562 feet} or less
Dimensions (excluding rubber feet and projections):	420 mm (W) x 88 mm (H) x 300 mm (D) {16-17/32 inches (W) x 3-15/32 inches (H) x 11-13/16 inches (D)}
Mass:	Approx. 5.3 kg {11.70 lbs} When two hard disk drives are installed: Approx. 6.7 kg {14.79 lbs.}
Finish:	Front view: Solid metallic coating Top cover: Solid metallic coating Rear view: Galvanized treatment

• HDD (Locally procured – Contact your dealer.)

Hard disk drive:	3.5 type Serial ATA hard disk drive (Up to 2 hard disk drives can be installed.)
------------------	--

• Input/Output

Video:	Video output connector: 1 V [p-p]/75 Ω, x1 (BNC) Monitor (HDMI) connector: HDMI, x2 (19-pin, type A) 1920×1080 p/60 Hz 1920×1080 i/60 Hz 1920×1080 p/50 Hz 1920×1080 i/50 Hz 720×480 p/60 Hz 720×576 p/50 Hz
Audio:	Audio output connector: –10 dBv, 600 Ω, unbalanced x1 (RCA pin jack)
Others:	Mouse connection port: x1 Copy port: x1 Alarm/Control connector: Alarm input 1-9 ch ^{*1} , Network error output ^{*2} , Alarm reset input ^{*1} , Face matching output ^{*2} , HDD error output ^{*2} , Camera error output ^{*2} , Recorder error output ^{*2} , Recording error output ^{*2} , Time adjustment signal input ^{*1} , Alarm output ^{*2} , +5 V output ^{*3} , (D-sub 25-pin) Network port: 10BASE-T/100BASE-TX/1000BASE-T (RJ-45), x2 Supported protocols: HTTP, RTP, TCP/IP, UDP/IP, FTP (Server), SMTP, NTP (Server, Client), DNS, DDNS, SNMP, POP3 SDHC/SD memory card slot: SDHC/SD memory cards applicable (miniSD cards and microSD cards not applicable)

*1 Make contact input, 50 kΩ +5 V DC pull-up

*2 Open collector output, 24 V DC, –100 mA max.

*3 200 mA max.

• Option

Additional Camera Kit	WJ-NVE30, WJ-NVE30W
Additional Business Intelligence Kit	WJ-NVF30, WJ-NVF30W
Recommended SDHC/SD memory card	Manufactured by Panasonic SDHC memory card: 4 GB, 8 GB, 16 GB, 32 GB SD memory card: 256 MB, 512 MB, 1 GB, 2 GB

Standard accessories

CD-ROM*	1 pc.
Mouse	1 pc.
Installation Guide (this book)	1 pc.
Quick Reference Guide.....	1 pc.
Activation Key Card	1 pc.
Warranty (provided with WJ-NV300K).....	1 pc.

The following are for installation:

Power cord (WJ-NV300K)	1 pc.
Power cord (WJ-NV300K/G).....	2 pcs.
HDD fixing screw	8 pcs.

* The CD-ROM contains the operating instructions (PDF).

Information for Users on Collection and Disposal of Old Equipment and used Batteries



These symbols on the products, packaging, and/or accompanying documents mean that used electrical and electronic products and batteries should not be mixed with general household waste.

For proper treatment, recovery and recycling of old products and used batteries, please take them to applicable collection points, in accordance with your national legislation and the Directives 2002/96/EC and 2006/66/EC.

By disposing of these products and batteries correctly, you will help to save valuable resources and prevent any potential negative effects on human health and the environment which could otherwise arise from inappropriate waste handling.

For more information about collection and recycling of old products and batteries, please contact your local municipality, your waste disposal service or the point of sale where you purchased the items.

Penalties may be applicable for incorrect disposal of this waste, in accordance with national legislation.



For business users in the European Union

If you wish to discard electrical and electronic equipment, please contact your dealer or supplier for further information.

[Information on Disposal in other Countries outside the European Union]

These symbols are only valid in the European Union. If you wish to discard these items, please contact your local authorities or dealer and ask for the correct method of disposal.



Cd

Note for the battery symbol (bottom two symbol examples):

This symbol might be used in combination with a chemical symbol. In this case it complies with the requirement set by the Directive for the chemical involved.

For U.S.A.

Disposal may be regulated in your community due to environmental considerations. For disposal or recycling information, please visit Panasonic website: <http://www.panasonic.com/environmental> or call 1-888-769-0149.

For U.S. and Canada:

Panasonic System Communications Company of North America, Unit of Panasonic Corporation of North America

www.panasonic.com/business/

For customer support, call 1.800.528.6747

Two Riverfront Plaza, Newark, NJ 07102-5490

Panasonic Canada Inc.

5770 Ambler Drive, Mississauga, Ontario, L4W 2T3 Canada

(905)624-5010

www.panasonic.ca

For Europe and other countries:

Panasonic Corporation

<http://panasonic.net>

Panasonic System Networks Co., Ltd.
Fukuoka, Japan

Authorised Representative in EU:

Panasonic Testing Centre
Panasonic Marketing Europe GmbH
Winsbergring 15, 22525 Hamburg, Germany

