

WV-U61300-ZYG

2MP (1080p) 3.1x Indoor PTZ Network Camera, Smoke Model

U series PTZ camera



- 2MP (1080p) 1920x1080
- 3.1x optical zoom
- Intelligent Auto
- Super Dynamic 144dB
- Color night vision (0.002 to 0.03 lx)
- Durable Pan/Tilt gear mechanism
- Built-in FIPS 140-2 Level 3 Certified Secure Element
(EdgeLock® SE050F NXP® Semiconductors)
- Smoke Model
- NDAA Compliant



SPECIFICATIONS

Camera	
Image Sensor	Approx. 1/2.8 type CMOS image sensor
Minimum Illumination	Color : 0.03 lx(50IRE, F1.3, 1/30s) Color : 0.002 lx(50IRE, F1.3, 16/30s) BW : 0.012 lx(50IRE, F1.3, 1/30s) BW : 0.0008 lx(50IRE, F1.3, 16/30s)
White Balance	ATW1 / ATW2 / AWC
Shutter Speed	[60 fps Mode] 1/60 Fix to 1/10000 Fix [30 fps/15 fps mode] 1/30 Fix to 1/10000 Fix [50 fps Mode] 1/50 Fix to 1/10000 Fix [25 fps/12.5 fps mode] 1/25 Fix to 1/10000 Fix
Intelligent Auto	On / Off
Super Dynamic	On / Off, The level can be set in the range of 0 to 31.
Dynamic Range	Max.144 dB (Super Dynamic : On, Level 31)
Adaptive Black Stretch	The level can be set in the range of 0 to 255.
Back light compensation / High light compensation	BLC (Back light compensation) / HLC (High light compensation) / Off The level can be set in the range of 0 to 31 (only when Super dynamic / Intelligent Auto : Off)
Fog compensation	On / Off, The level can be set in the range of 0 to 8 (only when Intelligent auto / auto contrast adjust : Off)
Maximum gain (AGC)	The level can be set in the range of 0 to 11.
Color/BW (ICR)	Off / On / Auto1 / Auto2 / Auto3 (SCC)
Digital Noise Reduction	The level can be set in the range of 0 to 255.
Video Motion Detection (VMD)	On / Off, 4 areas available
Scene Change Detection (SCD)	On / Off, 1 areas available
Audio Detection	On / Off
AI Sound Classification	—
AI Analytics	—
Privacy Zone	On / Off, Up to 8 zones available
VIQS	On / Off, Up to 8 zones available
Camera Title (OSD)	On / Off, Up to 40 characters (alphanumeric characters, marks)
Focus Adjustment	Auto focus
Lens	
Optical zoom	3.1x (Motorized zoom / Motorized Focus)
Extra zoom	Max. 4x (3.1 to 4x : When resolution is 1280 x 720)

Focal Length	2.9 - 9 mm {1/8 inches - 11/32 inches}
Angular Field of View	[16 : 9 mode] Horizontal : 36° (TELE) – 113° (WIDE), Vertical : 20° (TELE) – 60° (WIDE) [4 : 3 mode] Horizontal : 26° (TELE) – 82° (WIDE), Vertical : 20° (TELE) – 60° (WIDE)
Maximum Aperture Ratio	1 : 1.3 (WIDE) – 1 : 2.5 (TELE)
Focus Range	0.3 m {11-13/16 inches} – ∞

DORI

Detect (25ppm / 8ppf)	Wide: 25.4m / 83.4 ft, Tele: 118.2 m / 387.7 ft
Observe (62.5ppm / 19ppf)	Wide: 10.2 m / 33.4 ft, Tele: 47.3 m / 155.1 ft
Recognize (125ppm / 38ppf)	Wide: 5.1 m / 16.7 ft, Tele: 23.6 m / 77.5 ft
Identify (250ppm / 76ppf)	Wide: 2.5m / 8.3 ft, Tele: 11.8 m / 38.8 ft

System on Chip (SoC)

System on Chip (SoC)	Ambarella CV25M
----------------------	-----------------

Adjusting Angle

Adjusting Angle	Horizontal : 0 to +350° Vertical : 0 to +90°, Yaw : 0°
-----------------	---

Pan/tilt

Panning Range	0 – +350°
Panning Speed	Manual: Approx. 0.065°/s – 150°/s Preset: Up to approx. 150°/s
Tilting Range	Operational 0 – +90°
Tilting Speed	Manual: Approx. 0.065°/s – 150°/s Preset: Up to approx. 150°/s
Preset Positions	256 positions
Auto Mode	Auto pan/ Preset sequence/ Patrol
Self Return	10 s/ 20 s/ 30 s/ 1 min/ 2 min/ 3 min/ 5 min/ 10 min/ 20 min/ 30 min/ 60 min

Browser GUI

Camera Control	Brightness, AUX On / Off
Audio	Mic (Line) Input : On / Off Volume adjustment : Low / Middle / High Audio Output : On / Off Volume adjustment : Low / Middle / High
GUI / Setup Menu Language	English, Italian, French, German, Spanish, Portuguese, Russian, Chinese, Japanese
Browser	Microsoft Edge, Firefox, Google Chrome

Network

Network IF	10 Base-T / 100 Base-TX, RJ45 connector
Resolution H.265/ H.264 JPEG (MJPEG)	[16 : 9 mode (60 fps mode)] , [16 : 9 mode (30 fps mode)] , [16 : 9 mode (50 fps mode)] , [16 : 9 mode (25 fps mode)] 1920x1080, 1280x720, 640x360, 320x180 [4 : 3 mode (30 fps mode)] , [4 : 3 mode (25 fps mode)] 1280x960, VGA, QVGA [4 : 3 mode (15 fps mode)] , [4 : 3 mode (12.5 fps mode)] 2048x1536 , 1280x960, VGA, QVGA
H.265/H.264	[Transmission Mode] Constant bit rate / VBR / Frame rate / Best effort [Transmission Type] Unicast port (AUTO) / Unicast port (MANUAL) / Multicast

JPEG	[Image Quality] 10 steps
Smart Coding	GOP (Group of pictures control): Off/ Low (Variable GOP 1s-8s)/ Mid (Variable GOP 4s-16s)/ Advanced(Fixed GOP 60s w/1s key-frame)/ Frame rate control (Variable GOP 4s-16s with frame rate control) *Advanced and Frame rate control are only available with H.265. Smart VIQS: On(High)/On(Low)/Off, Smart P-picture control: On/Off
Audio Compression	G.726 (ADPCM) : 16 kbps / 32 kbps G.711 : 64 kbps AAC-LC : 64 kbps / 96 kbps / 128 kbps
Audio Transmission Mode	Off / Mic (Line) input / Audio output / Interactive (Half duplex) / Interactive (Full duplex)
Supported Protocol	IPv6 : TCP/IP, UDP/IP, HTTP, HTTPS, SSL/TLS, SMTP, DNS, NTP, SNMPv1/v2/v3, DHCPv6, RTP, MLD, ICMP, ARP, IEEE 802.1X, DiffServ, SFTP, MQTT, LLDP IPv4 : TCP/IP, UDP/IP, HTTP, HTTPS, SSL/TLS, RTSP, RTP, RTP/RTCP, SMTP, DHCP, DNS, DDNS, NTP, NMPv1/v2/v3, UPnP, IGMP, ICMP, ARP, IEEE 802.1X, DiffServ, SRTP, SFTP, MQTT, LLDP, NTCIP
No. of Simultaneous Users	Up to 14 users (Depends on network conditions)
Secure	FIPS 140-2 level 3 Certified Secure Element (NXP® EdgeLock® SE050F), Device Certificate GlobalSign® pre-installed, User authentication, Host authentication, HTTPS, 802.1X Support, Data encryption
SDXC/SDHC/SD Memory Card (Option)	H.265 / H.264 recording : Manual REC / Alarm REC (Pre/Post) / Schedule REC / Backup upon network failure JPEG recording : Manual REC / Alarm REC (Pre/Post) / Backup upon network failure Compatible SDXC/SDHC/SD Memory Card : microSDXC memory card : 64 GB, 128 GB, 256 GB, 512 GB microSDHC memory card : 4 GB, 8 GB, 16 GB, 32 GB microSD memory card : 2 GB
Mobile Terminal Compatibility	iPad, iPhone (iOS 8.0 or later), Android™ terminals
ONVIF® Profile	G / S / T

Alarm

Alarm Source	3 terminals input, VMD alarm, Command alarm, Audio detection alarm
Alarm Actions	SDXC/SDHC/SD memory recording, E-mail notification, HTTP alarm notification Indication on browser, TCP alarm notification output

Input/Output

Audio Input	ø3.5 mm stereo mini jack For microphone input : Recommended applicable microphone : Plug-in power type (Sensitivity of microphone : -51 dB to -38 dB (0 dB=1 V/Pa, 1 kHz)) Input impedance : Approx. 2 kΩ (unbalanced) / Supply voltage : 2.5 V ±0.5 V For line input : Input level : Approx. -10 dBV
Audio Output	ø3.5 mm stereo mini jack (monaural output) Output impedance : Approx. 600 Ω (unbalanced) Output level : -20 dBV
External I/O Terminals	ALARM IN 1 (Alarm input 1/ Black & white input/ Auto time adjustment input) (x1) ALARM IN 2 (Alarm input 2/ ALARM OUT) (x1), ALARM IN 3 (Alarm input 3/ AUX OUT) (x1)

General

Safety	UL (UL62368-1), c-UL (CSA C22.2 No.62368-1), CE, IEC62368-1
EMC	FCC (Part15 ClassA), ICES-003 Issue 7 ClassA, EN55032 ClassA, EN55035
Power Source and Power Consumption	DC12 V, PoE (IEEE802.3af) , DC12 V: 890 mA / Approx. 10.7 W PoE DC 48 V: 250 mA / Approx.12.0 W (Class 0 device)
Ambient Operating Temperature	-10 °C to +50 °C (+14 °F to +122 °F) (Power On range : 0 °C to +50 °C {+32 °F to +122 °F})
Ambient Operating Humidity	10 to 90 % (no condensation)
Anti-Condensation System	—

Dimensions	ø131 mm x 128 mm (H) {ø5-5/32 inches x 5-1/32 inches (H)}
Mass (Approx.)	Approx. 0.8 kg {1.76 lbs.}
Finish	Main body : Resin, i-PRO white Dome section : polycarbonate resin, Smoke

NOTES

Important

- Safety Precautions : Carefully read the Basic Information, Installation Guide and Operating Instructions before using this product.
- i-PRO Co., Ltd. cannot be held responsible for the performance of the network and/or other manufacturers' products used on the network.
- Masses and dimensions are approximate. - Specifications are subject to change without notice.

Trademarks and registered trademarks

- iPad and iPhone are trademarks of Apple Inc., registered in the U.S. and other countries. - Android is a trademark of Google LLC.
- ONVIF is a trademark of ONVIF, Inc.
- All other trademarks identified herein are the property of their respective owners

©i-PRO Co., Ltd All rights reserved / February 2023

OPTIONAL ACCESSORIES

Select a compatible accessory

[Accessory Selector \(i-pro.com\)](http://i-pro.com).



WV-QWL500-W
Mount Bracket



WV-QPL500-W
Mount Bracket



WV-QJB500-W
Mount Bracket



WV-QEM501-W
Ceiling Mount Bracket



WV-QCN500-W
Mount Bracket



WV-QCL101-W
Mount Bracket



WV-QCL100-W
Mount Bracket



WV-Q105A
Mount Bracket



WV-CF5SA
Dome Cover



WV-PM500
Compact microphone
unit for surveillance
cameras

APPEARANCE

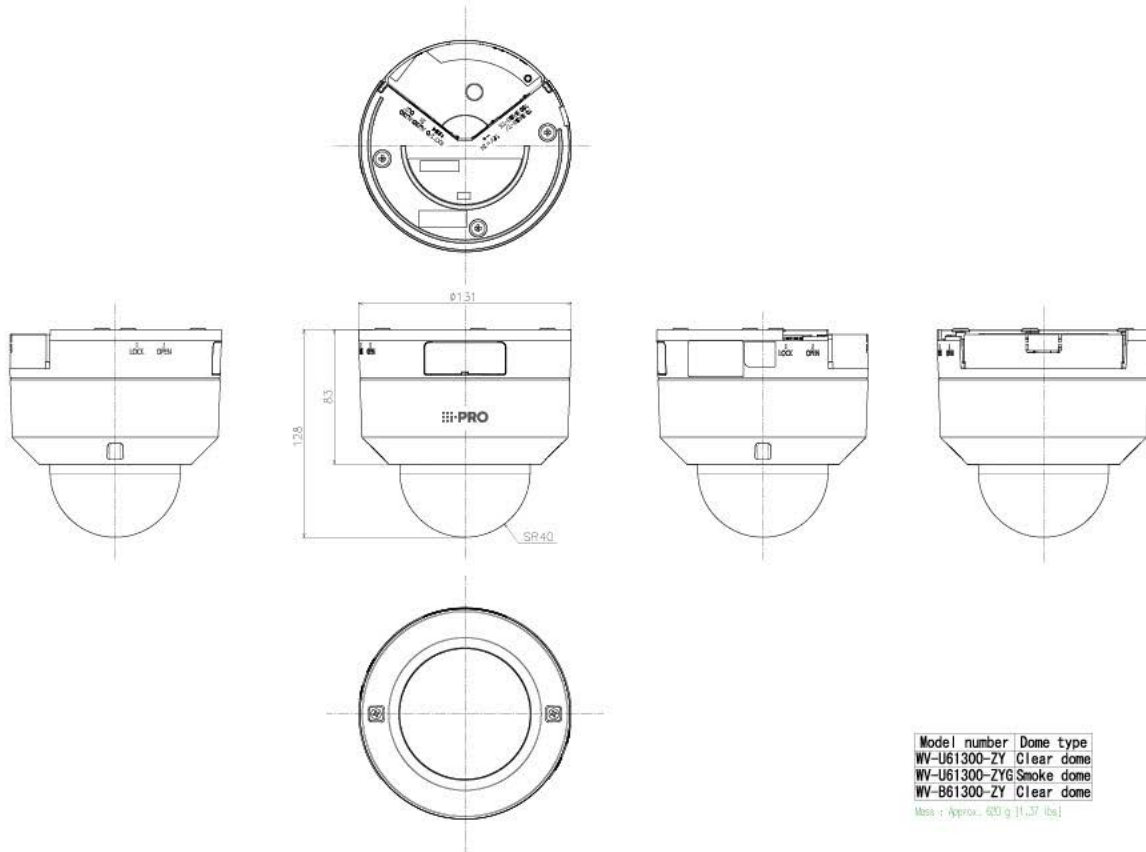

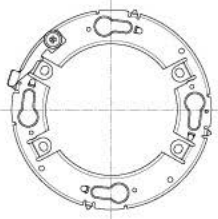

Attachment plate

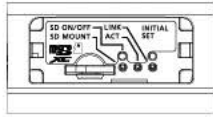

Inside of SD memory card cover
(S=2:1)

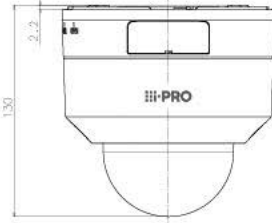
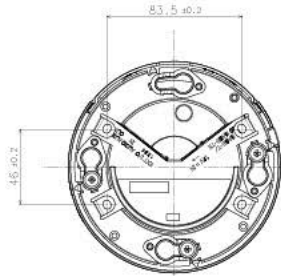

With Attachment plate

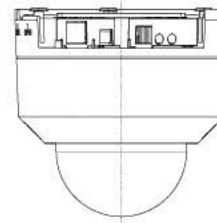
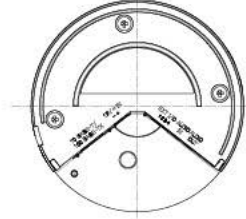
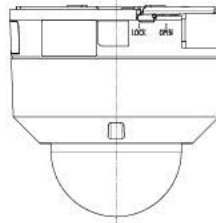

With the cable cover removed

Model number
 WV-U61300-ZY
 WV-U61300-ZYG
 WV-B61300-ZY

*Mass : Approx. 850 g [1.77 lbs] (When using the attachment plate)

金具との組み合わせ例
Example of combination with bracket

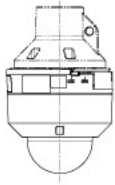

Attach to WV-QCL100-W

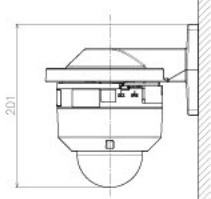

Attach to WV-QWL500-W

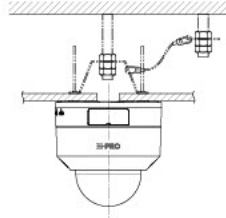

Attach to WV-QAT105A

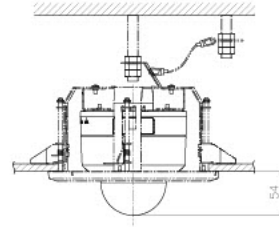

Attach to WV-QEM501-W

Model number
WV-U61300-ZY
WV-U61300-ZYG
WV-B61300-ZY