

## Installation Guide

Included Installation Instructions



Network Camera **For professional use only** **Indoor use**

Model No. **WV-S71300-F3**  
**WV-S71300A-F3**

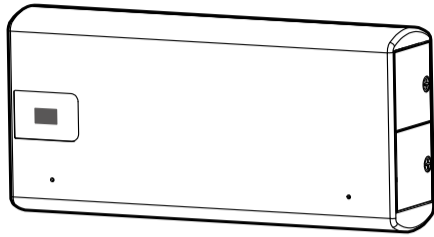

### About the user manuals

Product documentation is composed of the following documents.

- **Installation Guide (this document):** Provides information about "Precautions", "Precautions for installation" and the installation method.
- **Basic Information (Refer to the link on the following support website):** Provides information about "Precautions for use", "Parts and functions" and "Detail specifications".
- **Operating Instructions (Refer to the link on the following support website):** Explains how to perform the settings and how to operate this camera.  
<https://i-pro.com/global/en/surveillance/documentation-database>



"<Control No.: C\*\*\*\*>" used in these documents should be used to search for information on our technical information website (<https://i-pro.com/global/en/surveillance/training-support/support/technical-information>) and will guide you to the right information.



- Before attempting to connect or operate this product, please read these instructions carefully and save this manual for future use.
- microSDXC/ microSDHC/ microSD memory card is described as microSD memory card.
- The external appearance and other parts shown in this manual may differ from the actual product within the scope that will not interfere with normal use due to improvement of the product.

Authorised Representative in EU:  
i-PRO EMEA B.V.  
Laarderhoogtweg 25, 1101 EB  
Amsterdam, Netherlands



i-PRO EMEA B.V. UK Branch  
1010 Cambourne Business Park,  
Cambridgeshire CB23 6DP



\* PGQX2576YA \*



avs0322-1073  
Printed in China

i-PRO Co., Ltd.

Tokyo, Japan

<https://www.i-pro.com/>

© i-PRO Co., Ltd. 2022

### Disposal of Old Equipment and Batteries

#### Only for European Union and countries with recycling systems

These symbols on the products, packaging, and/or accompanying documents mean that used electrical and electronic products and batteries must not be mixed with general household waste. For proper treatment, recovery and recycling of old products and used batteries, please take them to applicable collection points in accordance with your national legislation.

By disposing of them correctly, you will help to save valuable resources and prevent any potential negative effects on human health and the environment.

For more information about collection and recycling, please contact your local authority.

Penalties may be applicable for incorrect disposal of this waste, in accordance with national legislation.

#### Note for the battery symbol (bottom symbol)

This symbol might be used in combination with a chemical symbol. In this case it complies with the requirement set by the Directive for the chemical involved.

For U.S.A.

**NOTE:** This equipment has been tested and found to comply with the limits for a Class A digital device, pursuant to Part 15 of the FCC Rules. These limits are designed to provide reasonable protection against harmful interference when the equipment is operated in a commercial environment. This equipment generates, uses, and can radiate radio frequency energy and, if not installed and used in accordance with the instruction manual, may cause harmful interference to radio communications. Operation of this equipment in a residential area is likely to cause harmful interference in which case the user will be required to correct the interference at his own expense.

**FCC CAUTION:** Changes or modifications not expressly approved by the party responsible for compliance could void the user's authority to operate the equipment.

#### Supplier's Declaration of conformity

Trade name : i-PRO  
Model No. : WV-S71300-F3  
WV-S71300A-F3  
Responsible Party :  
i-PRO Americas Inc.  
8550 Fallbrook Drive, Suite 200 Houston,  
Texas 77064  
Support Contact: 1-800-513-5417



For U.S.A.

The model number and serial number of this product may be found on the surface of the unit. You should note the model number and serial number of this unit in the space provided and retain this book as a permanent record of your purchase to aid identification in the event of theft.

Model No. \_\_\_\_\_  
Serial No. \_\_\_\_\_

For U.S.A.

This device complies with part 15 of the FCC Rules. Operation is subject to the following two conditions :  
(1) This device may not cause harmful interference, and  
(2) this device must accept any interference received, including interference that may cause undesired operation.

For Canada

CAN ICES-3(A)/NMB-3(A)

Méthode d'installation	Vis de fixation recommandée	La capacité de traction minimale requise
<b>Pour une installation au plafond</b> Platine de fixation d'installation: 260 g {0,57 lbs} Caméra vidéo: 197 g {0,43 lbs}	M6 x 16 mm {5/8 pouces}/ 4 él.	562 N {126 lbf}
<b>Pour une installation murale</b> Platine de fixation d'installation: 420 g {0,93 lbs} Caméra vidéo: 197 g {0,43 lbs}	M6 x 16 mm {5/8 pouces}/ 4 él.	724 N {163 lbf}

\* La longueur de la vis est un exemple lors de l'installation de la caméra au plafond ou sur un mur robuste d'une épaisseur de 20 mm {25/32 pouces} ou plus.

### WARNING:

- Operation of this product in a residential environment could cause radio interference.

### Caution:

- The DC power supply connected to the camera must be in the same building.
- The network camera is only intended for a connection to an ethernet or PoE network without routing to the outside plant.
- This product has no power switch. Be sure to install disconnect devices such as a circuit breaker to shut down the main power of power supplying equipment to this product.
- Only connect 5 V DC Class 2 power supply (UL 1310/CSA 223), limited power source (IEC/EN/UL/CSA 60950-1, IEC/EN/UL/CSA 62368-1 Annex Q) or IEC/EN/UL/CSA 62368-1 PS2.
- Before attempting to connect or operate this product, please read these instructions carefully.

### Notice:

- Do not install this product in locations where ordinary persons can easily reach.
- This product is a professional equipment.
- For information about screws and other parts required for installation, refer to the corresponding section of this document.

☐ : Direct current symbol

⚠ : Caution. Hot surface. Do not touch.

⚠ : Caution symbol

ℹ : Refer to manual symbol

🏠 : Indoor use symbol

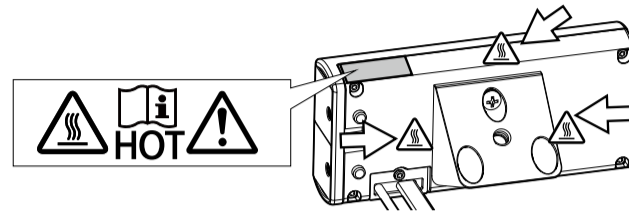

## Precautions

### Do not insert any foreign objects.

Fire or electrical shock may be caused if water or any foreign objects, such as metal objects, enter inside the unit.

Turn the power off immediately and contact qualified service personnel for service.

### Do not use this product in an inflammable atmosphere.

Failure to observe this may cause an explosion resulting in injury.

### Avoid installing this product in the locations where salt damage occurs or corrosive gas is produced.

Otherwise, the mounting portions will deteriorate and injury or accidents due to a fall of the product may occur.

### Do not strike or give a strong shock to this product.

Failure to observe this may cause injury or fire.

### Keep microSD memory cards away from infants and children.

Otherwise, they may swallow the cards by mistake.

In this case, consult a doctor immediately.

### Do not hang down from this product or use this product as a pedestal.

Failure to observe this may cause injury or accidents.

### Do not damage the power cable.

**Do not damage, fabricate, twist, stretch, bundle, or forcibly bend the power cable. Do not place heavy objects on it, and keep it away from heat sources.**

Use of a damaged power cable may cause electric shock, short circuit, or fire.

Consult the dealer for repair.

### Do not use paper or cloth on this product.

Failure to observe this may cause overheating and result in deformation, malfunction, or fire.

### Do not attempt to disassemble or modify this product.

Failure to observe this may cause fire or electric shock. Consult the dealer for the repair or inspections.

### Do not install or clean the camera, or touch this product, the power cable or the connected cables during thunder storms.

Failure to observe this may cause electric shock.

### Refer installation work to the dealer.

Installation work requires technique and experience. Failure to observe this may cause fire, electric shock, injury, or damage to the product. Be sure to consult the dealer.

### Stop the operation immediately when something is wrong with this product.

When smoke goes up from the product, the smell of smoke comes from the product, or the exterior of the product has deteriorated, continued use will cause a fire or fall of the product resulting in injury, or damage to the product.

In this case, turn the power off immediately and contact qualified service personnel for service.

### Select an installation area that can support the total weight.

Selecting an inappropriate installation surface may cause this product to fall down or topple over, resulting in injury or accidents. Installation work shall be started after sufficient reinforcement.

### Periodic inspections shall be conducted.

Rust on the metal parts or screws may cause a fall of the product resulting in injury or accidents.

Consult the dealer for the inspections.

### The screws and bolts must be tightened to the specified torque.

Failure to observe this may cause a drop resulting in injury or accidents.

### Install this product in a location to avoid people and objects from bumping into the product.

Failure to observe this may cause injury.

### The measures of protection against a fall of this product shall be taken.

Failure to observe this may cause a drop resulting in injury or accidents.

Be sure to install the safety wire.

### Do not install this product in locations subject to vibration.

Loosening of mounting screws or bolts may cause a fall of the product resulting in injury or accidents.

### Install the product securely on a installation surface in accordance with the installation instructions.

Failure to observe this may cause injury or accidents.

### Turn the power off when cleaning this product.

Failure to observe this may cause injury.

### Do not touch the hot part at the back of the camera.

Wait until the camera has cooled down before touching it. The camera is hot during and immediately after use.

## Open Source Software

- This product contains open source software licensed under GPL (GNU General Public License), LGPL (GNU Lesser General Public License), etc.
- Customers can duplicate, distribute and modify the source code of the software under license of GPL and/or LGPL.
- For details concerning licensing and source code of open source software, click "Click here for OSS information" on "Support" page of the setup menu of this product and read the displayed content.
- Please note that we shall not respond to any inquiries regarding the contents of the source code.

## Copyright

Except for open source software licensed under GPL/LGPL and so on, distributing, copying, disassembling, reverse compiling and reverse engineering of the software provided with this product are all expressly prohibited. In addition, exporting any software provided with this product violating export laws is prohibited.

## Trademarks and registered trademarks

- Microsoft, Windows, Windows Media, Microsoft Edge, and ActiveX are either registered trademarks or trademarks of Microsoft Corporation in the United States and/or other countries.
- Intel and Intel Core are trademarks of Intel Corporation or its subsidiaries in the U.S. and/or other countries.
- Adobe, Acrobat, and Reader are either registered trademarks or trademarks of Adobe in the United States and/or other countries.
- microSDXC Logo is a trademark of SD-3C, LLC.
- iPad and iPhone are trademarks of Apple Inc., registered in the U.S. and other countries.
- Android and Google Chrome are trademark of Google LLC.
- Firefox is a trademark of the Mozilla Foundation in the US and other countries.
- The word "QR Code" is a registered trademark of DENSO WAVE INCORPORATED in Japan and other countries.
- All other trademarks identified herein are the property of their respective owners.

## Precautions for installation

**i-PRO Co., Ltd. assumes no responsibility for injuries or property damage resulting from failures arising out of improper installation or operation inconsistent with this documentation.**

■ **In order to prevent injury, the product must be securely mounted to an installation surface according to Installation Guide.**

■ **Installation location when using an optional bracket or locally procured bracket**

Select an appropriate place for the installation area (such as a strong installation surface) in your particular environment.

- Make sure that the installation area is strong enough to hold this product, such as a concrete ceiling.
- Install the camera in the foundation area of the architecture or where sufficient strength is assured.
- Do not mount the product on a plaster board or a wooden section because they are too weak. If the product is unavoidably mounted on such a section, the section shall be sufficiently reinforced.

■ **This camera is designed to be used indoors**

This product is not operable outdoors. Do not expose this camera to direct sunlight for hours and do not install the product near a heater or an air conditioner. Otherwise, it may cause deformation, discoloration and malfunction.

Keep this camera away from water and moisture.

■ **Do not place this product in the following places**

- Locations where a chemical agent is used such as a swimming pool
- Locations subject to moisture or oil smoke such as a kitchen
- Locations that have a specific environment that is subject to an inflammable atmosphere or solvents
- Locations where a radiation, an X-ray, a strong radio wave or a strong magnetic field is generated
- Locations near coasts directly subjected to sea breezes, or locations subject to corrosive gases such as from hot springs, volcanic regions, etc.
- Locations where the temperature is not within the specified range
- Locations subject to vibrations, such as on vehicles, marine vessels, or above product lines (This product is not designed for on-vehicle use.)
- Locations where it may get directly wet from rain or water splash (including under the eaves, etc.)
- Locations subject to moisture or dust
- Locations subject to sudden changes in temperature such as near air discharge vents of air conditioners or air circulation inlet doors
- Locations near rubber products (packing, rubber feet, etc.)

■ **Screw tightening**

Do not use an impact driver. Use of an impact driver may damage the screws or cause tightening excessively.

■ **About reflection of light from outside or IR light**

A ghost may appear on the screen depending on the incident angle of external light.

In the case of using the IR light, installation of a camera near a wall may cause reflection of infrared rays resulting in a part of the screen or the entire screen turning whitish.

Refer to our support website <Control No.: C0109> for image examples and measures to take.

■ **Protection from lightning**

When cables are used outdoors, there is a chance that they may be affected by lightning. In such a case, install a lightning arrester close to the camera, and make the length of the network cable between the camera and lightning arrester as short as possible to prevent the camera from being affected by lightning.

■ **When noise disturbance may happen**

Noise may appear in video or audio near a strong electric field from a TV or radio antenna, motors and transformers, or a strong electric field/magnetic field from a power line (lamp line) of AC100 V or more. Conduct the power distribution work to keep 1 m {3.28 feet} away from them or conduct the electric conduit work using metal pipes. (Be sure to make ground connection of the metal pipes.)

■ **Make sure to remove this product if it will no longer be used.**

■ **This product has no power switch.**

When turning off the power, disconnect the power supply from the 5 V DC power supply or the PoE device.

■ **About the battery**

A battery is installed inside the camera. Do not leave the battery exposed in environments of excessive heat as a result of sunlight or fire.

■ **Equipment classification and power source indication label**

Refer to the indication label on the bottom side of this unit for the equipment classification, power source, and other information.

## Troubleshooting

Before requesting service, refer to "Troubleshooting" of Basic Information and Operating Instructions. Then, confirm the trouble.

## Specifications\* \*For further information, refer to the Basic Information.

Power source *1:	DC 5 V (USB Type-C terminal) (Not compatible with USB Power Delivery) PoE (IEEE802.3af compliant)
Power consumption *1:	DC 5 V: 1.9 A/Approx. 9.5 W PoE DC 48 V: 200 mA/Approx. 9.6 W (Class 0 device)
Operating environment Ambient operating temperature:	-10 °C to +40 °C {14 °F to 104 °F} (Power on range 0 °C to 40 °C {32 °F to 104 °F})
Ambient operating humidity:	10 % to 90 % (no condensation)
Storage environment Storage temperature: Storage humidity:	-30 °C to +60 °C {-22 °F to +140 °F} 10 % to 95 % (no condensation)
Built-in microphone:	Nondirectional electret condenser microphone x2
USB port:	High-speed serial interface (theoretical value: 480 Mbps) USB 2.0, 1 line
Waterproof and dustproof *2:	IP44 (IEC 60529)
Dimensions:	■ <b>Without protective cover</b> 102 mm (W) × 48 mm (H) × 21 mm (D) {4-1/32 inches (W) × 1-7/8 inches (H) × 13/16 inches (D)} (Depth when mounting seat is installed: +29.5 mm {+1-5/32 inches}) ■ <b>With protective cover</b> 103.5 mm (W) × 51 mm (H) × 24 mm (D) {4-1/16 inches (W) × 2 inches (H) × 15/16 inches (D)} (Depth when mounting seat is installed: +28 mm {+1-3/32 inches})
Weight *3:	■ <b>Without mounting seat</b> Approx. 169 g {0.37 lbs} ■ <b>With mounting seat</b> Approx. 197 g {0.43 lbs}
Finish	PC resin, Aluminum die cast i-PRO white

\*1 Refer to our technical information website <Control No.: C0106> for further information about Power source and Power consumption information.

\*2 Protection rating against solid objects (4: protection from wires, etc.) and water (4: water droplets from all directions).

\*3 Also includes the weight of the protective cover.

## Optional accessories



The latest information → Technical information website "Accessory Selector" <Control No.: C0501>

## Standard accessories

Installation Guide (this document) ..... 1 pc. Installation procedure leaflet..... 1 pc.

**The following parts are used during installation procedures.**

Mounting seat \*1 ..... 1 pc. Protective cover \*1 ..... 1 pc.  
Mounting seat fixing screw  
(M3 × 6 mm {1/4 inches}) \*1 ..... 2 pcs. Safety wire..... 1 pc.  
Washer ..... 1 pc.  
Fixing screw (M2 × 4 mm {3/16 inches}).... 1 pc. (spare) Spring washer ..... 1 pc.

\*1 The mounting seat, mounting seat fixing screws, and protective cover are attached to the camera.

## Other items that are needed (not included)

- Fixing screw

Installation method	Recommended screw *1	Minimum pull-out strength (per 1 pc.) *2
<b>For mounting on ceiling</b> Mount bracket: 260 g {0.57 lbs} Camera: 197 g {0.43 lbs}	M6 × 16 mm *3 *4 {5/8 inches} × 4 pcs.	562 N {126 lbf} *5
<b>For mounting on wall</b> Mount bracket: 420 g {0.93 lbs} Camera: 197 g {0.43 lbs}	M6 × 16 mm *3 *4 {5/8 inches} × 4 pcs.	724 N {163 lbf} *5

\*1 Select screws according to the material of the location that the camera will be mounted to. In this case, wood screws and nails should not be used.

\*2 This value indicates the minimum pull-out strength required value per screw. For information about the minimum pull-out strength, refer to our support website <Control No.: C0120>.

\*3 The screw length is an example when installing the camera on a robust ceiling or wall with a thickness of 20 mm {25/32 inches} or more.

\*4 The number of required screws or anchor bolts varies depending on the specifications of the mount bracket (locally procured). Refer to the operating instructions of the mount bracket (locally procured) for information about how to mount the mount bracket.

\*5 Make sure that the screws or anchor bolts separately procured when locally procuring a mount bracket for the ceiling or wall are capable of supporting the total weight (including the moment force when mounting to a wall).

- Ethernet cable with RJ45 plug (category 5e or better, straight, 4 pairs (8 pins))
- Power cable with USB Type-C connector as necessary
- Tools, insulation tape

■ **The protective cover**

(This product is installed with a transparent protective cover at the time of shipment from the factory.)

**Note:**

- If you will install this product in a high place that is out of reach, you can install it with the protective cover removed.

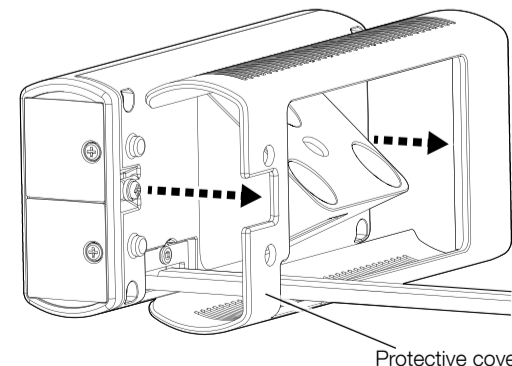

Protective cover

\* The descriptions in the Installation procedure leaflet use illustrations with the protective cover removed.

# 중요 안전 설명서 한국..... 8

**Français:**  
Ce document décrit les instructions importantes de sécurité. (☞ Page 3)  
Pour obtenir de plus amples informations, veuillez vous référer à chaque manuel disponible sur le site Web suivant.  
[https://i-pro.com/global/en/surveillance/documentation\\_database](https://i-pro.com/global/en/surveillance/documentation_database)

**Deutsch:**  
Dieses Dokument enthält wichtige Sicherheitshinweise. (☞ Seite 4)  
Weitere Informationen finden Sie in den einzelnen Handbüchern auf der folgenden Website.  
[https://i-pro.com/global/en/surveillance/documentation\\_database](https://i-pro.com/global/en/surveillance/documentation_database)

**Español:**  
Este documento describe instrucciones de seguridad importantes. (☞ Página 4)  
Para más información, consulte cada uno de los manuales en el siguiente sitio web.  
[https://i-pro.com/global/en/surveillance/documentation\\_database](https://i-pro.com/global/en/surveillance/documentation_database)

**Italiano:**  
Questo documento descrive importanti istruzioni di sicurezza. (☞ Pagina 5)  
Per ulteriori informazioni, fare riferimento a ciascun manuale sul sito web sottostante.  
[https://i-pro.com/global/en/surveillance/documentation\\_database](https://i-pro.com/global/en/surveillance/documentation_database)

**Русский:**  
В этом документе описываются важные сведения о безопасности. (☞ Стр. 5, 6)  
Для получения более подробной информации, см. в каждом руководстве на следующем веб-сайте.  
[https://i-pro.com/global/en/surveillance/documentation\\_database](https://i-pro.com/global/en/surveillance/documentation_database)

**Svenska:**  
Om de viktiga säkerhetsinstruktionerna inte förklaras på ditt språk i bruksanvisningen eller broschyren, kan du öppna URL-länken längst ner på sidan [2].

**Nederlands:**  
Als belangrijke veiligheidsinstructies in de instructiehandleiding of folder niet in uw taal worden uitgelegd, ga dan alstublieft naar de URL aan de onderkant van pagina [2].

**Suomi:**  
Jos tärkeitä turvallisuusohjeita ei ole selitetty käyttöohjeessa tai esitteessä omalla kielelläsi, siirry sivun [2] alareunassa mainittuun URL-osoitteeseen.

**Dansk:**  
Hvis vigtige sikkerhedsinstruktioner ikke er forklaret på dit sprog i brugervejledningen eller på indlægssedlen, bedes du gå på internetadressen nederst på side [2].

**Português:**  
Se as instruções de segurança importantes não foram explicadas em seu idioma no manual de instrução ou no folheto, acesse a URL na parte inferior da página [2].

**Ελληνικά:**  
Εάν σημαντικές οδηγίες ασφαλείας, δεν εξηγούνται στη γλώσσα σας στο εγχειρίδιο οδηγιών ή στο φυλλάδιο, παρακαλούμε επισκεφθείτε τη διεύθυνση URL στο κάτω μέρος της σελίδας [2].

**Magyar:**  
Amennyiben az Ön nyelvén a fontos biztonsági utasítások magyarázata hiányzik a használati útmutatóból vagy a prospektusból, kérjük, keresse fel a [2]. oldal alján található URL-címet.

**Čeština:**  
Pokud nejsou důležité bezpečnostní pokyny v návodu k použití nebo na letáku vysvětleny ve vašem jazyce, navštivte prosím webovou stránku s URL adresou uvedenou ve spodní části stránky [2].

**Polski:**  
Jeśli ważne instrukcje bezpieczeństwa nie są wyjaśnione w Twoim języku w instrukcji obsługi lub ulotce, przejdź do adresu URL podanego na dole strony [2].

**Slovenščina:**  
Če pomembna varnostna navodila niso opisana v vašem jeziku v navodilih za uporabo ali brošuri, odprite spletni naslov na dnu [2]. strani.

**Slovensky:**  
Ak dôležité bezpečnostné pokyny nie sú vysvetlené vo vašom jazyku v návode na použitie alebo v písomnej informácii pre používateľov, prejdite na adresu URL v dolnej časti stránky č. [2].

**Eesti keel:**  
Kui olulised ohutusjuhised pole kasutusjuhendis või teabelehel teie keeles toodud, külastage lehekülje [2] allosas olevat veebiaadressi.

**Latviešu:**  
Ja lietošanas rokasgrāmatā vai informatīvajā lapā jūsu valodā nav izskaidrotas svarīgas drošības instrukcijas, lūdzam izmantot [2]. lpp. apakšdaļā norādīto URL vietrādi.

**Lietuvių:**  
Jei svarbios saugos instrukcijos jūsų kalba nepateiktos vartotojo vadove ar informaciniame lapelyje, pasinaudokite [2] puslapio apačioje pateikta nuoroda.

**Български:**  
Ако важните инструкции за безопасност не са обяснени на вашия език в ръководството за употреба или листовката, моля, влезте на URL адреса в долната част на страница [2].





**Română:**  
Dacă instrucțiunile de siguranță importante nu sunt explicate în limba dvs. în manualul de instrucțiuni sau în prospect, accesați adresa URL din partea de jos a paginii [2].

**Hrvatski:**  
Ako važne sigurnosne upute nisu objašnjene na vašem jeziku u priručniku za uporabu ili na letku, molimo pristupite URL-u na dnu stranice [2].

[https://i-pro.com/global/en/surveillance/training\\_support/support/library/isi2](https://i-pro.com/global/en/surveillance/training_support/support/library/isi2)





## IMPORTANT SAFETY INSTRUCTIONS

**WARNING:**  
• Operation of this product in a residential environment could cause radio interference.

<p><b>Caution:</b></p> <ul style="list-style-type: none"> <li>The DC power supply connected to the camera must be in the same building.</li> <li>The network camera is only intended for a connection to an ethernet or PoE network without routing to the outside plant.</li> <li>This product has no power switch. Be sure to install disconnect devices such as a circuit breaker to shut down the main power of power supplying equipment to this product.</li> <li>Only connect 5 V DC Class 2 power supply (UL 1310/CSA 223), limited power source (IEC/EN/UL/CSA 60950-1, IEC/EN/UL/CSA 62368-1 Annex Q) or IEC/EN/UL/CSA 62368-1 PS2.</li> <li>Before attempting to connect or operate this product, please read these instructions carefully.</li> </ul>	<p><b>Notice:</b></p> <ul style="list-style-type: none"> <li>Do not install this product in locations where ordinary persons can easily reach.</li> <li>This product is a professional equipment.</li> <li>For information about screws and other parts required for installation, refer to the corresponding section of this document.</li> </ul> <p> : Direct current symbol</p> <p> : Caution. Hot surface. Do not touch.</p> <p> : Caution symbol</p> <p> : Refer to manual symbol</p> <p> : Indoor use symbol</p>
---	---





## WICHTIGE SICHERHEITSHINWEISE

**WARNING:**  
• Der Betrieb dieses Produkts in einem Wohngebiet kann Funkstörungen verursachen.

<p><b>Vorsicht:</b></p> <ul style="list-style-type: none"> <li>Die Gleichstromversorgung für dieses Gerät muss aus demselben Gebäude stammen.</li> <li>Die Netzwerkkamera ist für den Anschluss an ein Ethernet- bzw. PoE-Netzwerk bestimmt und darf nicht nach außen geroutet werden.</li> <li>Dieses Produkt besitzt keinen Netzschalter. Installieren Sie daher Trennvorrichtungen wie einen Schutzschalter, um die Hauptleistung der Stromversorgungsanlagen zu diesem Produkt unterbrechen zu können.</li> <li>Schließen Sie nur ein 5-V-Gleichstromnetzgerät der Klasse 2 (UL 1310/CSA 223), ein Netzgerät mit begrenzter Leistung an (IEC/EN/UL/CSA 60950-1, IEC/EN/UL/CSA 62368-1 Anhang Q) oder IEC/EN/UL/CSA 62368-1 PS2.</li> <li>Bitte lesen Sie diese Bedienungsanleitung vor dem Anschließen und der Inbetriebnahme dieses Produkts aufmerksam durch.</li> </ul>	<p><b>Hinweis:</b></p> <ul style="list-style-type: none"> <li>Stellen Sie dieses Produkt nicht an Orten auf, die von gewöhnlichen Personen leicht zu erreichen sind.</li> <li>Dieses Produkt ist ein professionelles Gerät.</li> <li>Informationen zu den erforderlichen Schrauben und anderen Teilen für den Einbau finden Sie im entsprechenden Abschnitt dieses Dokuments.</li> </ul> <p> : Gleichstromsymbol</p> <p> : Vorsicht. Heiße Oberfläche. Nicht berühren.</p> <p> : Vorsicht-Symbol</p> <p> : Symbol, das auf Anleitung verweist</p> <p> : Symbol zur Verwendung im Innenbereich</p>
--	--





## INSTRUCTIONS IMPORTANTES DE SÉCURITÉ

**AVERTISSEMENT :**  
• L'utilisation de ce produit dans un environnement résidentiel peut provoquer des interférences radio.

<p><b>Attention:</b></p> <ul style="list-style-type: none"> <li>L'alimentation CC connectée à la caméra vidéo doit se trouver dans le même bâtiment.</li> <li>La caméra vidéo de réseau est seulement prévue pour un raccordement à un réseau Ethernet ou au réseau PoE sans acheminement à l'installation extérieure.</li> <li>Ce produit ne possède aucun interrupteur d'alimentation. Assurez-vous d'installer des dispositifs de déconnexion tel qu'un disjoncteur pour couper la puissance principale des équipements d'alimentation à ce produit.</li> <li>Connectez uniquement une source d'alimentation 5 V CC Classe 2 (UL 1310/CSA 223), une source d'alimentation limitée (IEC/EN/UL/CSA 60950-1, IEC/EN/UL/CSA 62368-1 Annexe Q) ou IEC/EN/UL/CSA 62368-1 PS2.</li> <li>Nous vous recommandons de lire attentivement ces instructions avant de raccorder ou d'utiliser cet appareil.</li> </ul>	<p><b>Remarque:</b></p> <ul style="list-style-type: none"> <li>N'installez pas ce produit dans des endroits facilement accessibles par des personnes ordinaires.</li> <li>Ce produit est un équipement professionnel.</li> <li>Pour plus d'informations sur les vis et les autres pièces requises pour l'installation, reportez-vous à la section correspondante de ce document.</li> </ul> <p> : Symbole de courant continu</p> <p> : Attention. Surface brûlante. Ne pas toucher.</p> <p> : Symbole de mise en garde</p> <p> : Symbole indiquant que l'utilisateur doit consulter le mode d'emploi</p> <p> : Symbole d'utilisation à l'intérieur</p>
---	---

## INSTRUCCIONES DE SEGURIDAD IMPORTANTES

**ADVERTENCIA:**  
• El uso de este producto en entornos residenciales podría causar interferencias de radio.

<p><b>Precaución:</b></p> <ul style="list-style-type: none"> <li>La fuente de alimentación de CC conectada a la cámara debe estar en el mismo edificio.</li> <li>La cámara de red está solamente preparada para una conexión a una Ethernet o red PoE sin enrutamiento a la planta exterior.</li> <li>Este producto no tiene interruptor de alimentación. Asegúrese de instalar dispositivos de desconexión como, por ejemplo, un disyuntor para apagar la alimentación principal del equipo de suministro de energía a este producto.</li> <li>Conectar solamente a una fuente de alimentación de 5 V CC de Clase 2 (UL 1310/CSA 223), una fuente de alimentación limitada (IEC/EN/UL/CSA 60950-1, IEC/EN/UL/CSA 62368-1 Anexo Q) o IEC/EN/UL/CSA 62368-1 PS2.</li> <li>Antes de conectar o de poner en funcionamiento este aparato, lea atentamente estas instrucciones.</li> </ul>	<p><b>Aviso:</b></p> <ul style="list-style-type: none"> <li>No instale este producto en lugares donde las personas comunes puedan acceder fácilmente.</li> <li>Este producto es un equipo profesional.</li> <li>Para obtener información sobre los tornillos y otras piezas necesarias para la instalación, consulte la sección correspondiente de este documento.</li> </ul> <p> : Símbolo de la corriente continua</p> <p> : Precaución. Superficie caliente. No tocar.</p> <p> : Símbolo de precaución</p> <p> : Símbolo para consultar el manual</p> <p> : Símbolo de uso en interiores</p>
---	--



## IMPORTANTI ISTRUZIONI DI SICUREZZA

### AVVERTENZA:

- Il funzionamento di questo prodotto in un ambiente residenziale potrebbe causare interferenze radio.

### Precauzione:

- L'alimentatore CC collegato alla telecamera deve trovarsi nello stesso edificio.
- La telecamera di rete è progettata per il collegamento ad una rete Ethernet o PoE senza instradamento sull'impianto esterno.
- Questo prodotto non ha un interruttore di alimentazione. Assicurarsi di installare dispositivi di disconnessione quali un interruttore automatico per arrestare l'alimentazione principale dell'apparecchiatura che fornisce alimentazione a questo prodotto.
- Collegare solo alimentazione elettrica da 5 V CC Classe 2 (UL 1310/CSA 223), una fonte di alimentazione limitata (IEC/EN/UL/CSA 60950-1, IEC/EN/UL/CSA 62368-1 Allegato Q) o IEC/EN/UL/CSA 62368-1 PS2.
- Prima di tentare di collegare o utilizzare questo prodotto, si prega di leggere attentamente queste istruzioni.

### Avviso:

- Non installare questo prodotto in luoghi in cui chiunque possa avere facile accesso.
- Questo prodotto è un'apparecchiatura professionale.
- Per informazioni sulle viti e sulle altre parti necessarie per l'installazione, fare riferimento alla sezione corrispondente del presente documento.

☰ : Simbolo di corrente continua

☹ : Attenzione. Superficie bollente. Non toccare.

⚠ : Simbolo di attenzione

📖 : Consultare il simbolo del manuale

🏠 : Utilizzare al chiuso

## ВАЖНЫЕ СВЕДЕНИЯ О БЕЗОПАСНОСТИ

### ВНИМАНИЕ:

- Эксплуатация данного изделия в жилых районах может вызвать радиопомехи.

### Внимание:

- Источник постоянного тока, подключенный к камере, должен находиться в том же здании.
- Сетевая камера предназначена только для подключения к сети Ethernet или PoE без маршрутизации на линейные сооружения.
- Данный продукт не имеет выключателя сети. Обязательно установите отключающие устройства, такие как автоматический выключатель, для отключения основного питания оборудования, использующегося для подачи питания на данное изделие.
- Подключайте только источник питания пост.т. 5 V класса 2 (UL 1310/CSA 223), источник питания с ограниченной мощностью (IEC/EN/UL/CSA 60950-1, IEC/EN/UL/CSA 62368-1, приложение Q) или IEC/EN/UL/CSA 62368-1 PS2.
- Прежде чем приступить к подсоединению или управлению настоящим изделием, следует тщательно изучить настоящую инструкцию.

### Примечание:

- Не устанавливайте данное устройство в легкодоступных для обычных людей местах.
- Это изделие является профессиональным оборудованием.
- Для получения информации о винтах и других деталях, необходимых для установки, обратитесь к соответствующему разделу данного документа.

☰ : Символ постоянного тока

☹ : Внимание! Горячая поверхность! Не прикасаться!

⚠ : Символ предупреждения

📖 : Символ необходимости справиться с руководством

🏠 : Символ использования внутри помещений

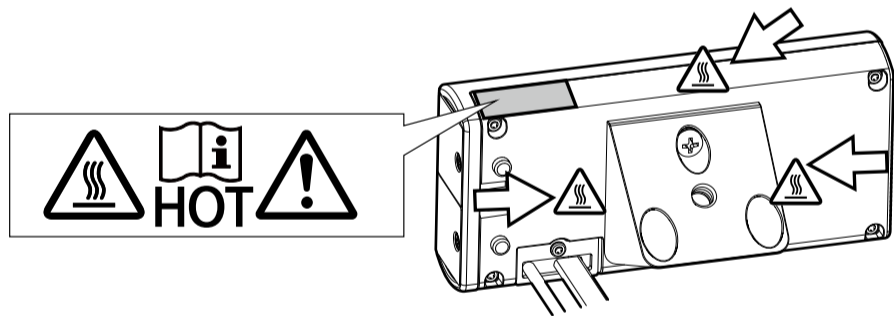

## 중요 안전 설명서

### 경고:

- 이 제품은 가정에서 작동하면 전파 간섭이 일어날 수 있습니다.

### 주의:

- 카메라에 연결된 DC 전원 공급 장치는 동일한 건물에 있어야 합니다.
- 네트워크 카메라는 외부 시설로 라우팅하지 않는 이더넷 또는 PoE 네트워크 연결 전용입니다.
- 본 기기에는 전원 스위치가 없습니다. 이 제품에 전력을 공급하는 기기의 주전원을 차단할 수 있도록 회로 차단기 등의 차단 장치를 반드시 설치하십시오.
- Class2 5V DC 전원 (UL 1310/CSA 223), LPS (limited power source) (IEC/EN/UL/CSA 60950-1, IEC/EN/UL/CSA 62368-1 Annex Q) 또는 IEC/EN/UL/CSA 62368-1 PS2 에만 연결하십시오.
- 사용 설명서를 잘 읽으신 후 올바르게 안전하게 사용하십시오.

### 주의 사항:

- 본 제품을 일반인이 쉽게 접근할 수 있는 장소에 설치하지 마십시오.
- 본 기기는 전문가용 기기입니다.
- 설치에 필요한 나사 및 기타 부품에 대한 정보는 이 문서의 해당 부분을 참조하십시오.

☰ : 직류 기호

☹ : 주의. 고온 표면. 만지지 마십시오.

⚠ : 주의 기호

📖 : 설명서 기호 참조

🏠 : 실내 사용 기호

### 사용자 안내문

이 기기는 업무용 환경에서 사용할 목적으로 적합성평가를 받은 기기로서 가정용 환경에서 사용하는 경우 전파간섭의 우려가 있습니다.

### Panasonic Korea Ltd.

서울특별시 서초구 서초대로 254 오피런스 17층  
서비스문의 : 1588-8452  
<https://www.panasonic.co.kr/>

※ 사용자 안내문은 “업무용 방송통신기자재”에만 적용한다.